



iPhone 14 Pro

iPhone 14 Pro Max

Apple Recycler Guide

June 2023

Contents

3	About This Guide
4	Identification
5	Directive 2012/19/EU Annex VII Components
6	Safety Considerations
9	Recommended Tools
10	Disassembly Instructions
25	Material Categorization of Output Fractions

About This Guide

Apple Recycler Guides provide guidance for electronics recyclers on how to disassemble products to maximize recovery of resources. The guides provide step-by-step disassembly instructions and information on the material composition to help recyclers direct fractions to the appropriate material recycler.

To conserve important resources, we work to reduce the materials we use and aim to one day source only recycled or renewable materials in our products. A key path to reaching that goal is resource recovery from end-of-life electronics.

Disassembly procedures are intended to be performed only by trained electronics recycling professionals. The recycler is responsible for independently evaluating and ensuring compliance with all applicable environmental, health, and safety laws related to the work. These include but are not limited to laws relating to the management, handling, shipping, and disposal of the outputs of this work as waste and laws in place to ensure the health and safety of all employees who support this work.

For questions or feedback about this guide, email contactesci@apple.com.

Note: This guide may show images from other similar models, but the procedures are the same.

Identification

Generally, you can find the model number for the iPhone inside the SIM tray slot.

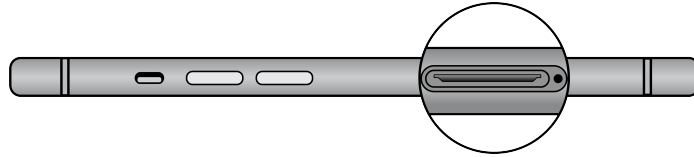

Model numbers:
A2889, A2890, A2891, A2892, A2893, A2894, A2895, A2896

For an iPhone without a SIM tray slot, use the diagonal measure to identify the model:

- iPhone 14 Pro (6.1 inch or 15.5 cm diagonal)
- iPhone 14 Pro Max (6.7 inch or 17 cm diagonal)

iPhone 14 Pro



Model number:
A2650

iPhone 14 Pro Max

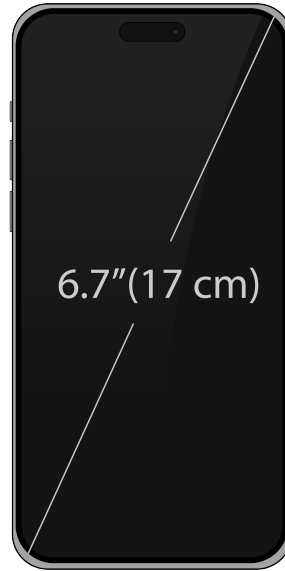

Model number:
A2651

Directive 2012/19/EU Annex VII Components

Directive 2012/19/EU Annex VII requirements apply to the following substances and components.

Substance/Component	Apple Part Name	Removal Instructions
Printed circuit board if the surface is greater than 10 square centimeters	Display logic board, main logic board	Follow steps 1–13
External electric cables	Charge cable	Follow step 1
Battery	Lithium-ion polymer battery	Follow steps 1–7
Cover glass and organic light-emitting diode (OLED) display if the surface is greater than 100 square centimeters	OLED display	Follow steps 1–6
No further substances or components as listed in Annex VII		

Safety Considerations

The recycler is responsible for independently evaluating all activities undertaken by its employees to perform or support the work and ensuring compliance with all applicable health and safety laws related to the work. These include but are not limited to laws relating to the health and safety of all employees who perform or support this work. The recycler is also responsible for evaluating the workspace and ensuring that the area in which the work is to be undertaken is designed using ergonomic best practices and meets all ergonomic requirements to ensure the protection of its employees.

Broken OLEDs must be handled properly to ensure the safety of your employees and mitigate any hazards. Package broken OLEDs in an appropriate container to properly manage the hazards associated with the materials and store only with compatible materials. All waste must be properly classified, packaged, and labeled in accordance with all relevant laws and regulations.

Personal Protective Equipment

Personal protective equipment should be worn during the entire recycling process.



Wear hand protection



Wear foot protection



Wear eye protection



Wear a mask



Wear protective clothing

Battery Safety

This product uses a lithium-ion polymer battery. Before beginning any disassembly work, ensure that a safe working procedure for handling lithium-ion batteries has been established, which could include discharging the batteries so that they can be more safely managed. The following considerations may also be included:

- Remove anything from your person that could conduct energy, such as jewelry and watches, to avoid electric shock to yourself or the logic board.
- To avoid the potential for thermal runaway and the release of potentially noxious fumes, don't puncture, strike, or crush lithium-ion polymer batteries or devices powered by them.
- Don't throw, drop, or bend the battery.
- Don't expose the battery to excessive heat or sunlight.
- Don't use tools that are sharp or conduct electricity.
- Keep your workspace clear of foreign objects and sharp materials.

- Dispose of batteries according to local environmental laws and guidelines.

Workspace safety guidelines

- Use heat-resistant gloves and safety glasses.
- Keep a sand dispenser within arm's reach (2 feet or 0.6 m) on one side of the workstation, not above the workstation. The dispenser should be a wide-mouthed, quick-pour metal container with a flip-top lid or tray that contains 8–10 cups (1.9–2.4 L) of clean, dry, untreated sand.
- Keep the battery at least 2 feet (0.6 m) from paper and other combustible materials.
- Work in an area with adequate ventilation.

Handling a thermal runaway

If you notice any of the following signs, a thermal runaway is likely underway, and you should act immediately:

- The lithium-ion polymer battery or a device containing one begins to smoke or emit sparks or soot.
- The battery pouch suddenly and quickly puffs out.
- You hear hissing or popping sounds.

Don't use water or an ABC/CO₂ fire extinguisher on a thermal runaway battery or a device containing one. Water and ABC/CO₂ fire extinguishers will not stop the reaction.

Do smother the battery or device immediately with plenty of clean, dry sand, dumped all at once. Timing is critical; the faster you pour all the sand, the faster the thermal runaway will stop.

Do leave the room for 30 minutes if the thermal runaway causes any irritation.

Do wait 30 minutes before touching the battery. Wear heat-resistant gloves and safety glasses to remove the battery from the sand, or use a touchless thermometer to measure the battery temperature. Only touch the battery when the event has finished.

Do dispose of the damaged battery or device (including any debris removed from the sand) according to local environmental laws and guidelines.

OLED Safety

Broken OLEDs must be handled properly to ensure the safety of your employees and mitigate any hazards. Package broken OLEDs in an appropriate container to properly manage the hazards associated with the materials and store only with compatible materials. All waste must be properly classified, packaged, and labeled in accordance with all relevant laws and regulations.

Hazard Warnings



Broken glass hazard



Chemical inhalation hazard



Rechargeable battery hazard

Recommended Tools

Flat-blade screwdriver

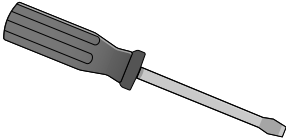

Miniature plastic pry bar

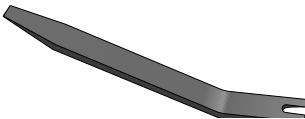

Miniature pry bar

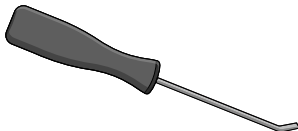

Nail-pulling screwdriver

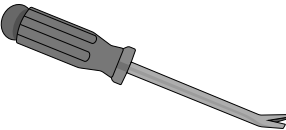

SIM-eject tool



Slip-joint pliers

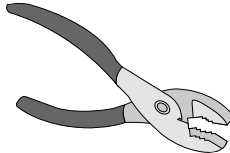

Tweezers



Disassembly Instructions

1. Remove the charge cable.

» *Ensure that the iPhone is turned off.*

» *Disconnect the charge cable.*

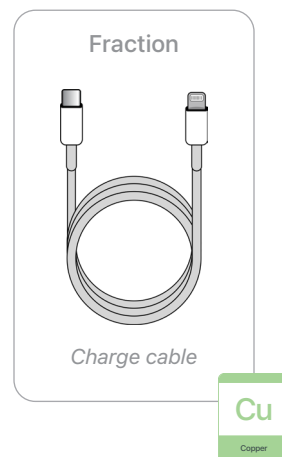
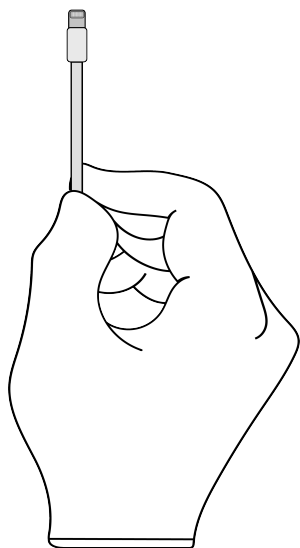
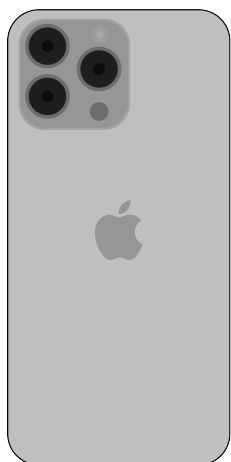

2. Remove the OLED display.



Broken glass hazard



Chemical inhalation hazard

Tools Used

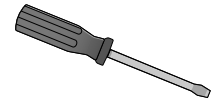

- » *Hold the iPhone at the edge of a counter with the display face up and the Lightning connector toward the counter edge.*
- » *Insert the tool tip into the Lightning connector. Push the handle down to pry the display from the enclosure.*

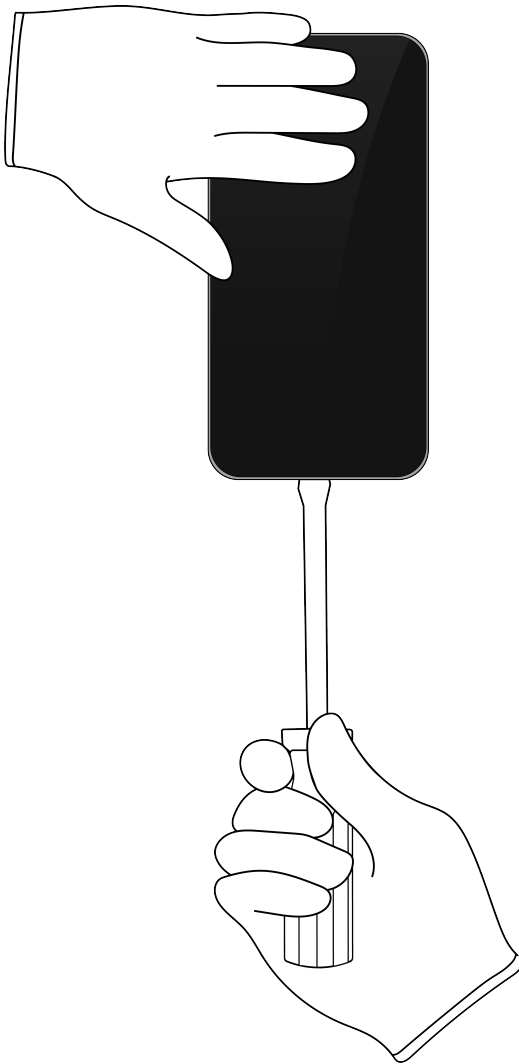

» Remove the OLED display by hand. Set the enclosure aside.

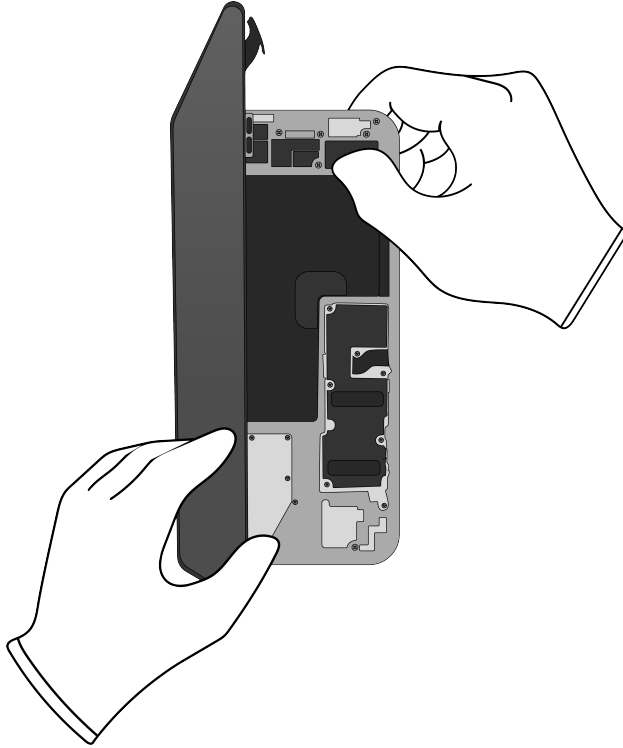

3. Separate the display frame from the OLED display.

- » *With the display facedown, pry the display frame away from the OLED display.*

Tools Used

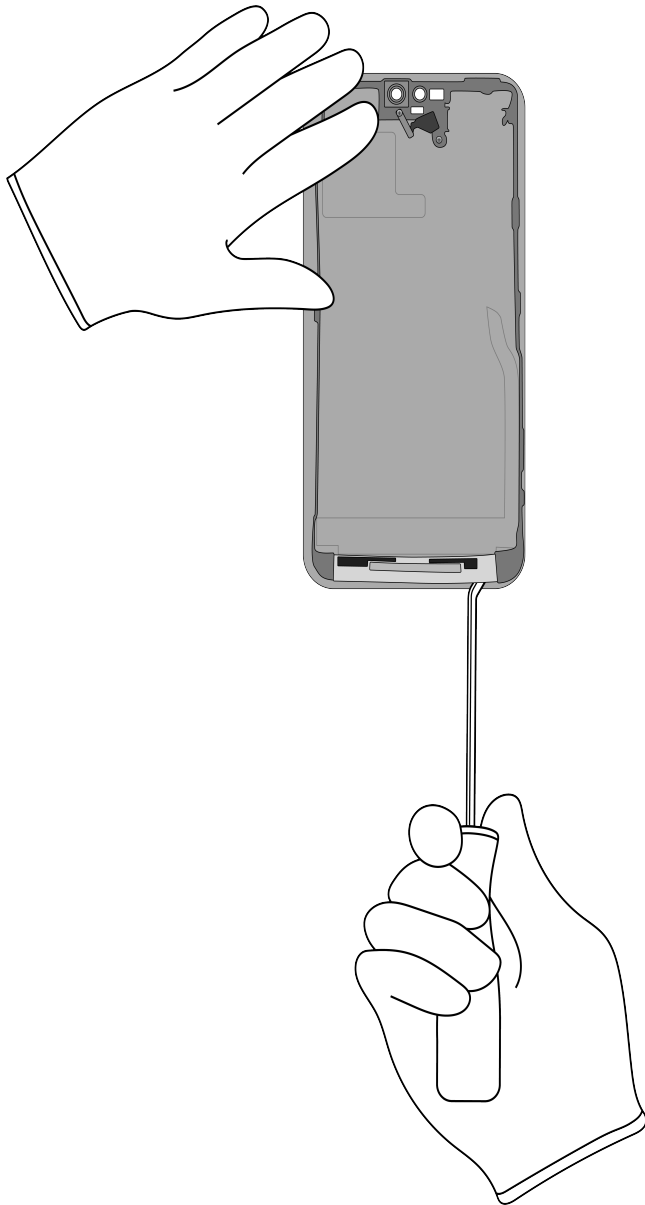

- » *Pull off the display frame by hand. Set the OLED display aside.*

4. Remove the light sensor from the display frame.

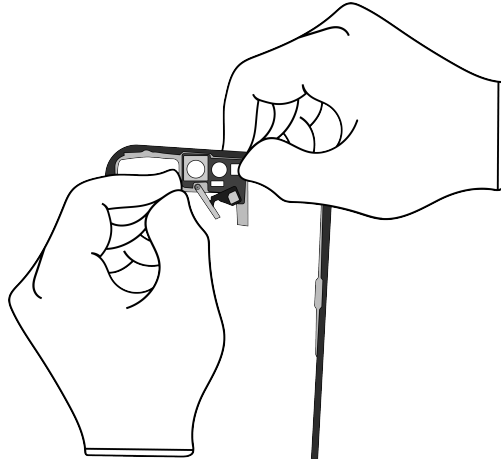

Fraction



Light sensor

Cu
Copper

A rounded rectangular box containing the text 'Fraction' at the top, an illustration of the light sensor component in the middle, and the text 'Light sensor' below it. To the right of the box is a green vertical bar with the chemical symbol 'Cu' and the word 'Copper' below it.

Fraction



Display frame

Fe
Ferrous

A rounded rectangular box containing the text 'Fraction' at the top, an illustration of the display frame component in the middle, and the text 'Display frame' below it. To the right of the box is a green vertical bar with the chemical symbol 'Fe' and the word 'Ferrous' below it.

5. Remove the display logic board from the OLED display.

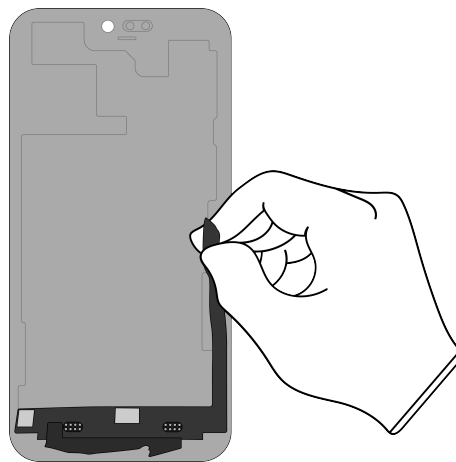

Fraction



Display logic board

PMs
Precious Metals

A rounded rectangular box containing the text 'Fraction' at the top, an illustration of the display logic board component in the middle, and the text 'Display logic board' below it. To the right of the box is a green vertical bar with the chemical symbol 'PMs' and the words 'Precious Metals' below it.

6. Peel off the display backing.

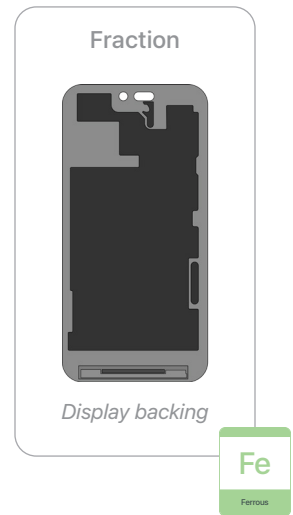
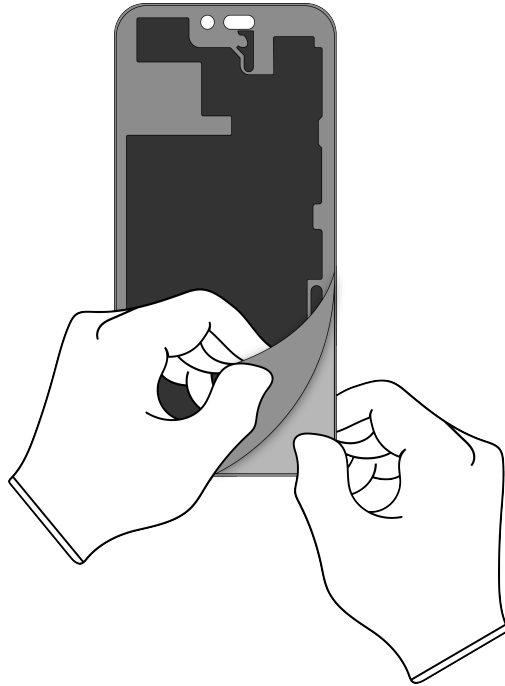

7. Inside the enclosure, carefully remove the lithium-ion polymer battery.



Rechargeable battery hazard

- » *Using tweezers, gently peel one of the black battery adhesive tabs away from the battery.*
- » *Twist the tab around the tweezers until white adhesive appears. Continue twisting until the entire adhesive strip is removed.*
- » *Repeat this process for any remaining battery tabs. Continue with the miniature plastic pry bar if needed.*

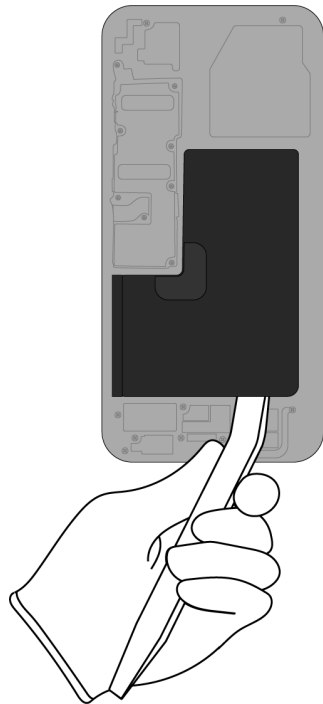

Tools Used



Fraction



Lithium-ion polymer battery

BT

Battery

8. (Models with a SIM tray slot) Remove the SIM tray.

» Using the SIM-eject tool, remove the SIM tray.

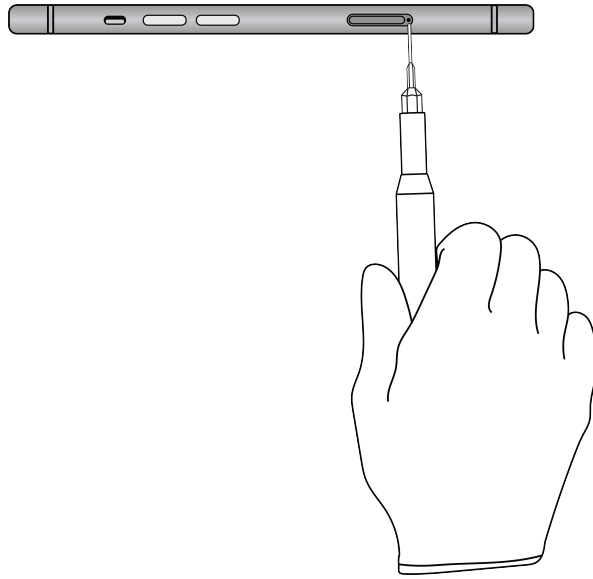

Tools Used



» Separate the SIM card from the SIM tray.

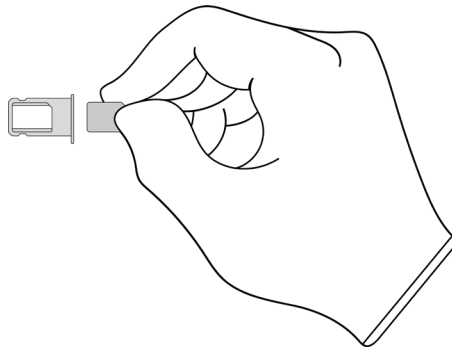

Fraction



SIM card

PMs
Precious Metals

Fraction

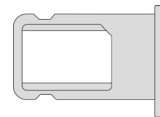

SIM tray

Al
Aluminum

9. Pry off the camera cover.

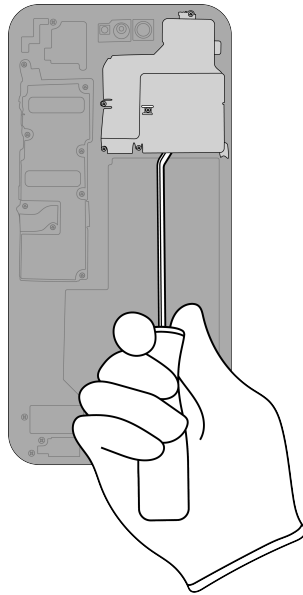

Tools Used



Fraction

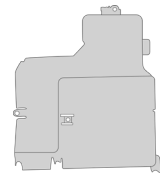

Camera cover

Fe

Ferrous

10. Pry off the rear camera.

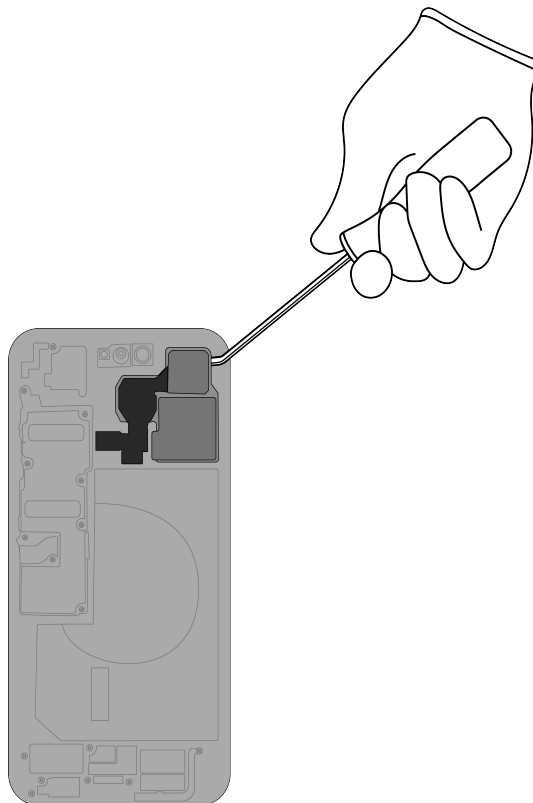

Tools Used



Fraction



Rear camera

PMs

Precious Metals

11. Pry off the front camera.

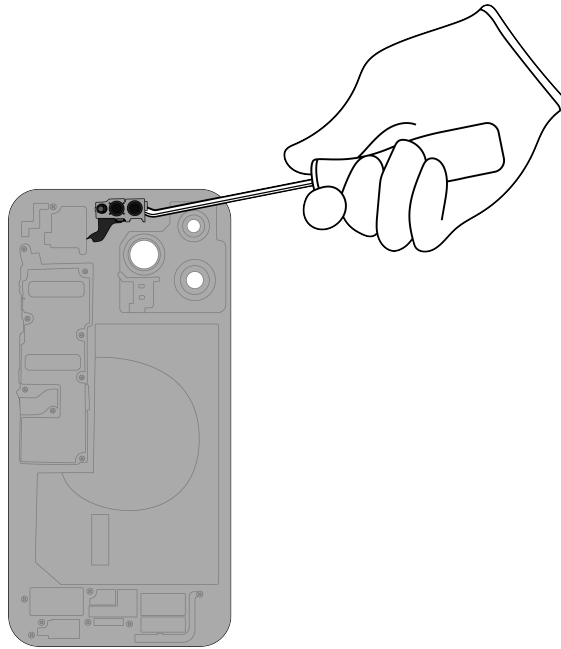

Tools Used



Fraction



Front camera

PMs
Precious Metals

12. Pry off the receiver.

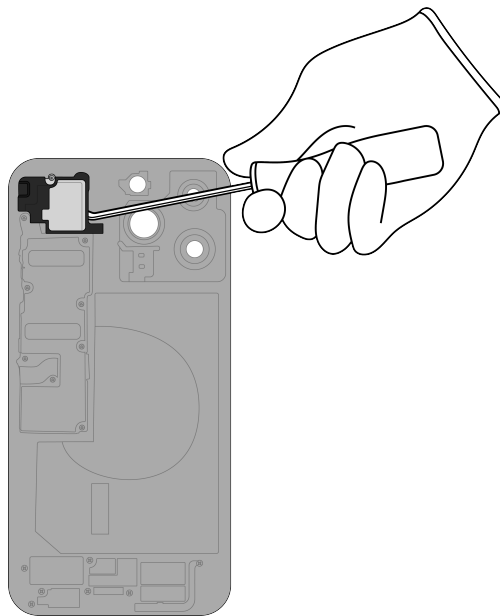

Tools Used



Fraction

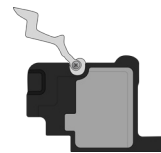

Receiver

REE
Rare Earth Elements

13. Pry off the main logic board.

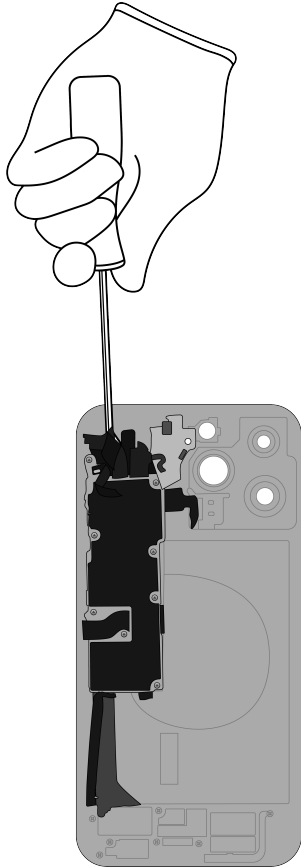

Tools Used



Fraction

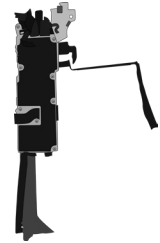

Main logic board



14. Pry off the LiDAR Scanner.

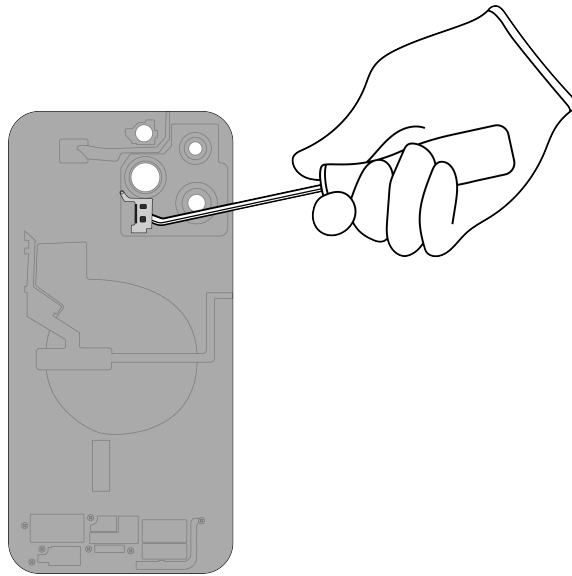

Tools Used



Fraction



LiDAR Scanner

Cu

Copper

15. Pry off the microphone.

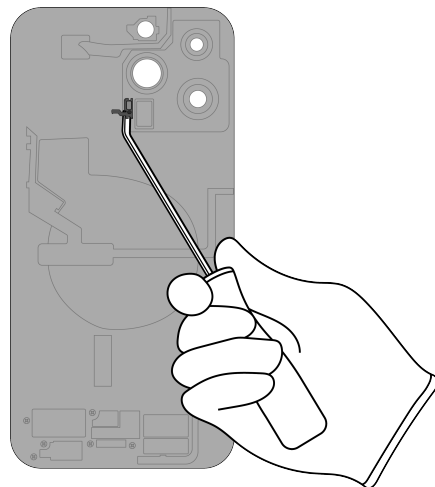

Tools Used



Fraction



Microphone

Cu

Copper

16. Pry off the strobe.

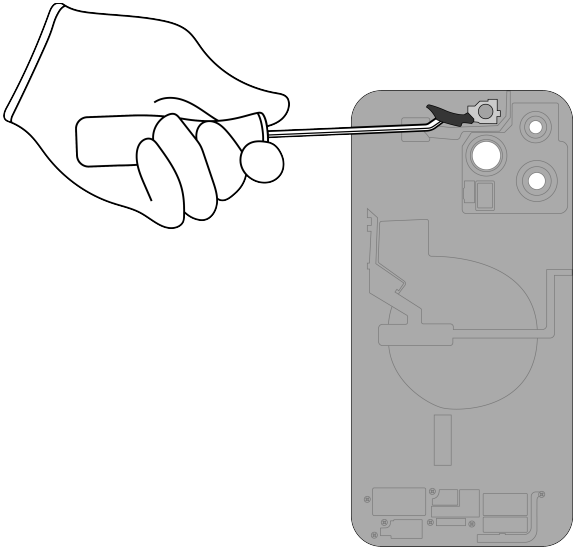

Tools Used



Fraction



Strobe

Cu

Copper

17. Pry off the Taptic Engine and speaker.

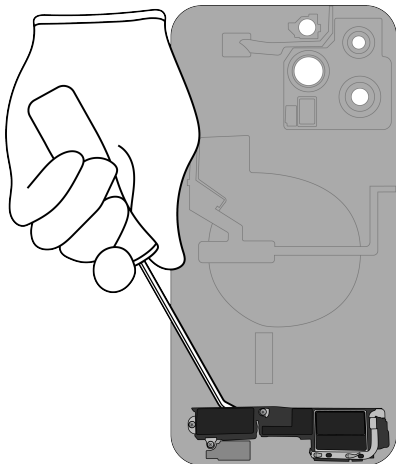

Tools Used



Fraction



Taptic Engine and speaker

REE

Rare Earth Elements

18. Pry off the Lightning connector.

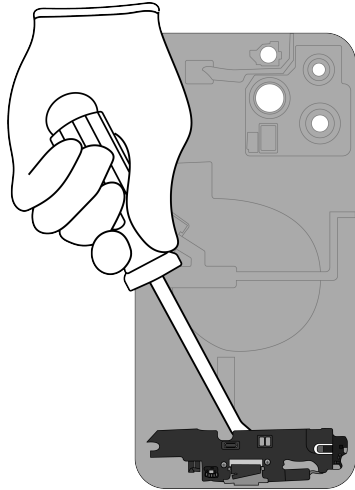

Tools Used

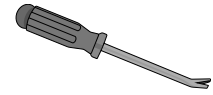

Fraction



Lightning connector



19. Pull the enclosure band off the support plate.

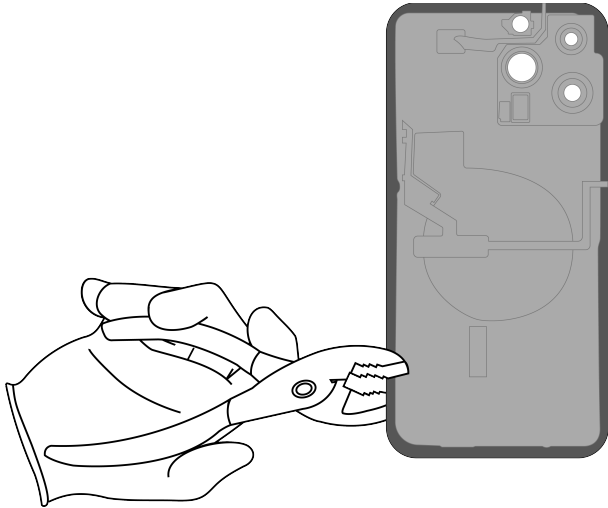

Tools Used

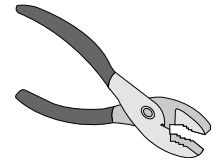

Fraction

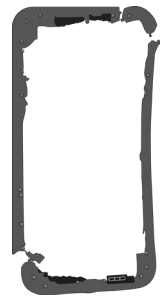

Enclosure band

Fe

Ferrous

Fraction



Support plate

Cu

Copper

Material Categorization of Output Fractions

All outputs from this process must be managed, handled, and disposed of in accordance with applicable waste laws and regulations, including but not limited to the Waste Framework Directive and its national enactments in Europe.

Fraction	Downstream Processing
----------	-----------------------

Aluminum

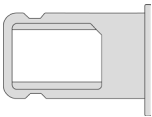

*SIM tray
(except in models A2650, A2651)*

Primary Target Material



Potential Additional Materials



Batteries



Lithium-ion polymer battery

Primary Target Material



Fraction **Downstream Processing**

Ferrous



Display frame



Display backing

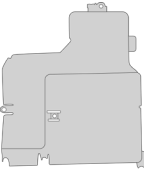

Camera cover

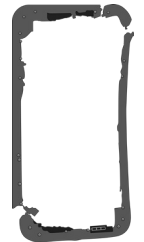

Enclosure band

Primary Target Material



Potential Additional Materials



Fraction	Downstream Processing
----------	-----------------------

Glass



OLED display

Primary Target Material



Potential Additional Materials



Logic Boards

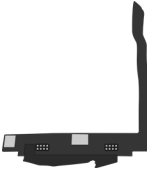

Display logic board



*SIM card
(except in models A2650, A2651)*



Rear camera

Primary Target Material



Potential Additional Materials

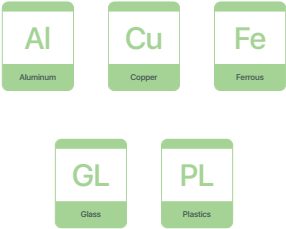

Logic Boards (cont.)



Front camera



Main logic board

Mixed Electronics

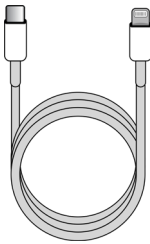

Charge cable



Light sensor

Primary Target Material



Potential Additional Materials



Mixed Electronics (cont.)



LiDAR Scanner

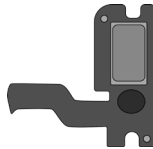

Microphone



Strobe



Lightning connector



Support plate

Fraction

Downstream Processing

Rare Earth Magnets

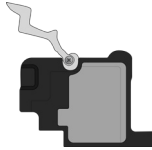

Receiver



Taptic Engine and speaker

Primary Target Material



Potential Additional Materials

