



Pro Display XDR

Recycler Guide

Mart 2021

İçindekiler

- 3 Bu Kılavuz Hakkında
- 4 Kimlik İşareti
- 5 Özel İşlem Gerektiren Bileşenler
- 6 Güvenlik ile İlgili Hususlar
- 7 Önerilen Araçlar
- 8 Demontaj Talimatları
- 19 Çıktı Parçacıklarının İşlenmesi

Bu Kılavuz Hakkında

Apple Recycler Guide içerikleri, kaynakların en üst düzeyde geri kazanılması için ürünlerin elektronik geri dönüştürücülerle güvenle demonte edilmesi hakkında yönergeler sunar. Kılavuzlar adım adım demontaj talimatlarının yanı sıra malzeme içerikleri hakkında bilgiler sunarak geri dönüştürücülerin parçacıkları uygun malzeme geri dönüştürücüsüne yönlendirebilmesini sağlar.

Önemli kaynakların korunması adına kullandığımız malzemeleri azaltmaya yönelik çalışmalar yapıyoruz ve gelecekte ürünlerimizde sadece geri dönüştürülmüş veya yenilenebilir malzemeler kullanmayı hedefliyoruz. Bu hedefe ulaşmanın önemli bir yolu da kullanım ömrü sona eren elektronik ürünlerden kaynak geri kazanımı gerçekleştirmektir.

Demontaj süreçleri sadece eğitimli elektronik malzeme geri dönüştürme uzmanları tarafından gerçekleştirilebilecek şekilde tasarlanmıştır. Geri dönüştürücü, iş ile ilgili tüm çevre, sağlık ve güvenlik yasalarının değerlendirilmesi ve bunlara uyulmasından bağımsız olarak sorumludur. Sorumluluklar; yönetim, taşıma, nakliye ve bu işin çıktılarının atık olarak imha edilmesi ve bu işe destek veren tüm çalışanların sağlığının ve güvenliğinin sağlanması hakkındaki yasaları içerir ancak bunlarla sınırlı değildir.

Bu kılavuz ile ilgili sorular veya geri bildirim için contactesci@apple.com adresine e-posta gönderin.

Kimlik İşareti



Model numarası:
A1999

Özel İşlem Gerektiren Bileşenler

Aşağıdaki maddelerin ve bileşenlerin Direktif 2021/19/EU Ek VII uyarınca özel işlem için ayrılması gerekir.

Madde/Bileşen	Konum	Sökme Talimatları
Yüzey alanı 10 santimetrekareden büyük olan baskılı devre kartları	Anakartlar, ekran anakartları, LED dizilimi anakartları	1'den 7'ye kadar olan adımları takip edin
Yüzeyi 100 santimetrekareden büyük koruyucu camlar ve LCD hücreleri	Koruyucu cam ve LCD hücresi	1'den 3'e kadar olan adımları takip edin
Harici elektrik kabloları	Thunderbolt 3 Pro kablo, AC güç kablosu	1. adımı takip edin
Ek VII'de yer alan başka madde veya bileşen yoktur		

Güvenlik ile İlgili Hususlar

Geri dönüştürücü; işi gerçekleştiren veya destekleyen çalışanlarının yaptığı tüm etkinlikleri değerlendirmekle ve iş ile ilgili geçerli tüm sağlık ve güvenlik yasalarına uyumluluğu sağlamakla bağımsız olarak sorumludur. Sorumluluklar; işi gerçekleştiren veya destekleyen tüm çalışanların sağlığı ve güvenliğini düzenleyen yasaları içerir ancak bunlarla sınırlı değildir. Geri dönüştürücü ayrıca çalışma alanının değerlendirilmesinden ve işin gerçekleştirileceği alanın ergonomik en iyi uygulamalar kullanılarak tasarlandığından ve çalışanlarının korunmasını sağlayacak tüm ergonomik gereksinimleri karşıladığından bağımsız olarak sorumludur.

Tehlike Uyarısı



Kırık cam tehlikesi



Ellerin zarar görme tehlikesi



Kimyasal soluma tehlikesi



Keskin cisimler

Kişisel Koruyucu Donanım

Tüm geri dönüştürme süreci boyunca kişisel koruyucu donanım giyilmelidir.



Elleri koruyucu donanım giyin



Maske takın



Gözleri koruyucu donanım kullanın



Koruyucu ayakkabılar giyin



Koruyucu kıyafetler giyin

Önerilen Araçlar

Düz uçlu tornavida

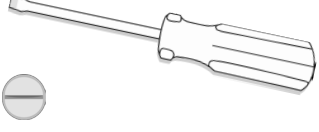

Düz yüzey kazıyıcı



Çekiç

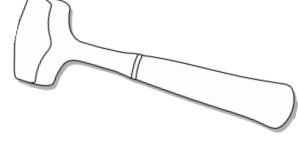

Ağır keski



Vida sökücü tornavida

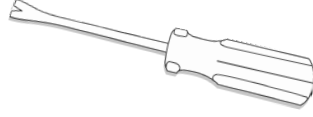

Demontaj Talimatları

1. Ekran güç kablosunu ve Thunderbolt 3 Pro kabloyu cihazdan sökün.

» Ekrani kapatın.



» Kabloları sökün.

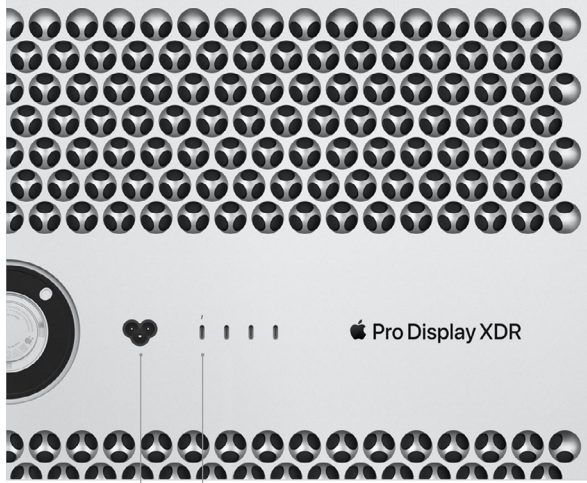
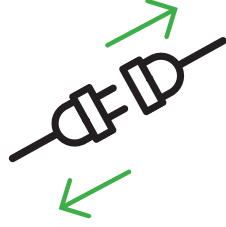

Thunderbolt 3 (USB-C) bağlantı noktası
Güç bağlantı noktası

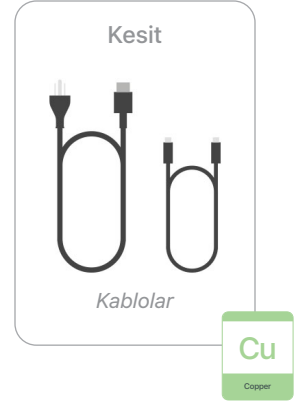

2. Standı sökün. Pro Stand'ınız varsa ilk talimat grubunu takip edin. VESA montaj adaptörü için ikinci talimat grubunu takip edin.

» Pro Display XDR'ı Pro Stand'dan ayırın.

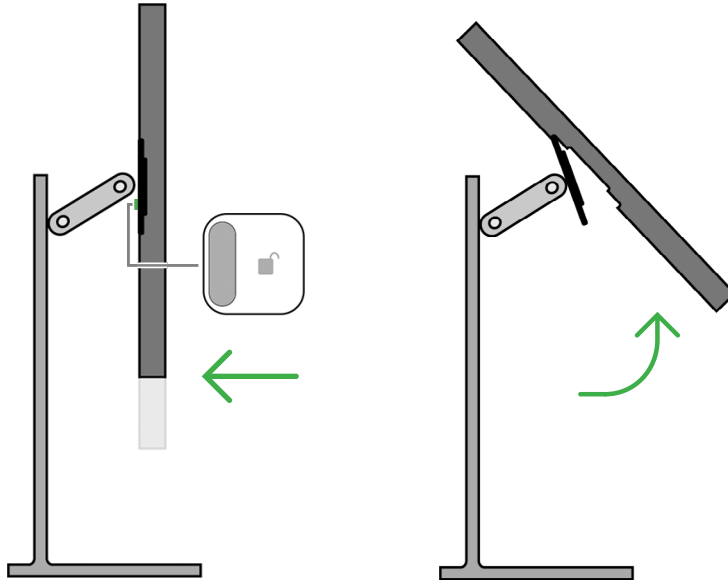
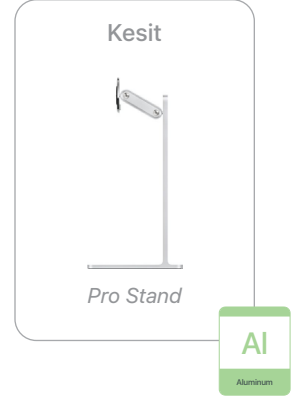
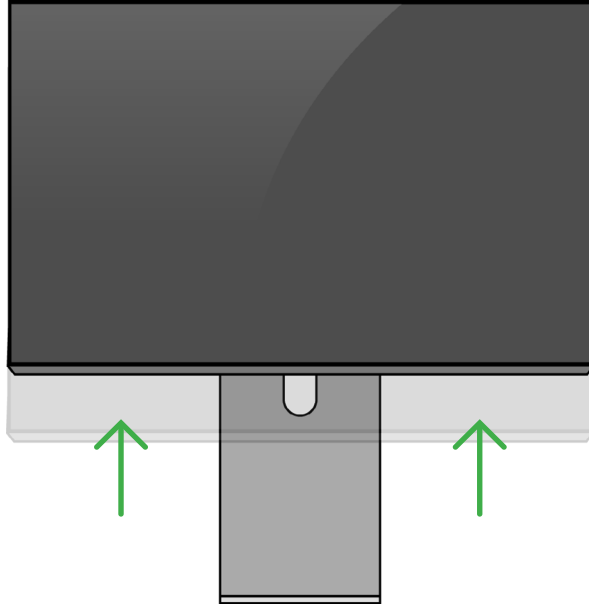

»» Pro Display XDR'ı VESA montaj adaptöründen ayırın.

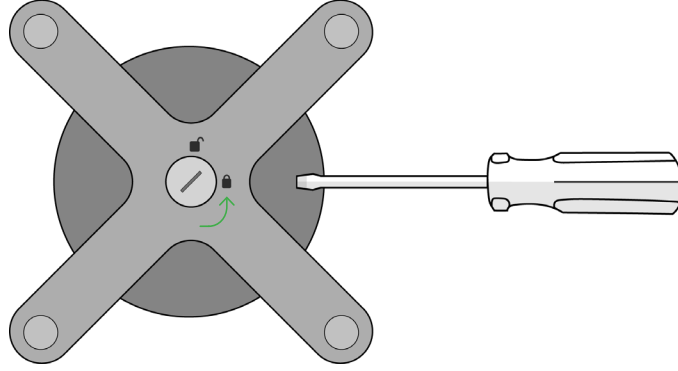

Kullanılan Araçlar



Kesit

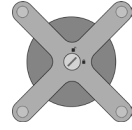

VESA montaj
adaptörü

Al

Alüminyum



3. Koruyucu camı ve LCD hücreni sökün.



Kırık cam tehlikesi

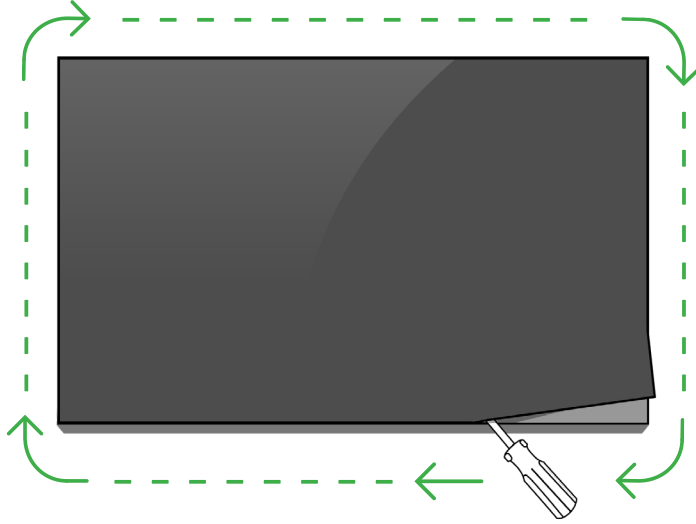

Kullanılan Araçlar



Kesit



Koruyucu cam
ve LCD hücresi

GL

Glass

Kesit

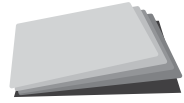

Filmler

PL

Plastics

4. Ekran bağılı iki anakartı sökün.



Keskin cisimler

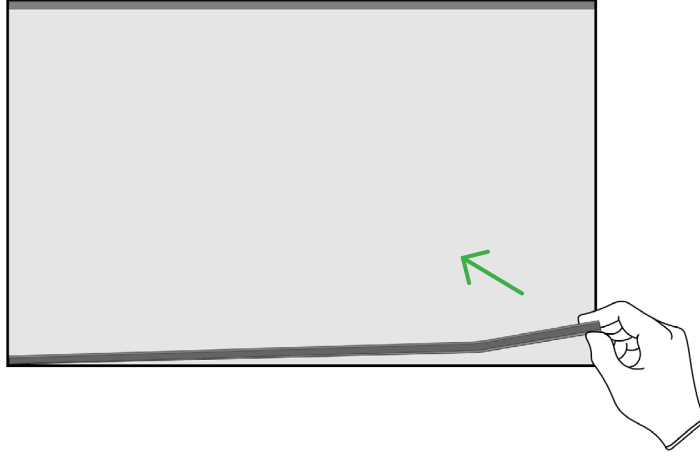

Kesit



Ekran
anakartı (x2)

PMs
Precious
Metals

5. LED dizilimini sökün.

Kullanılan Araçlar

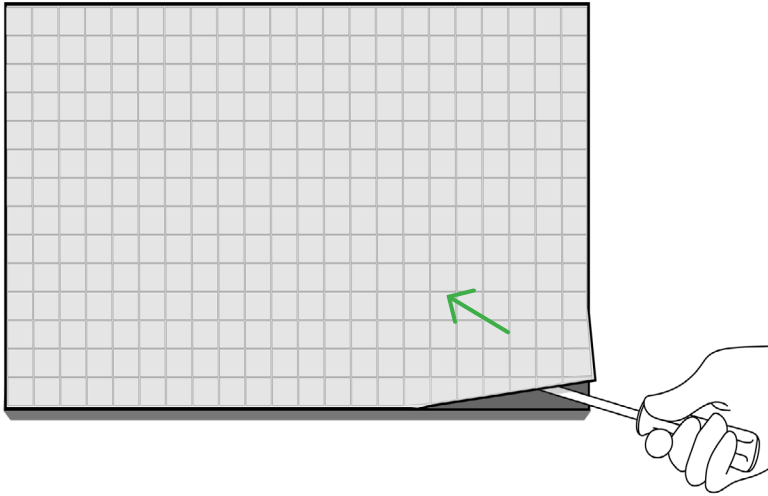

» LED dizilimini tabandan çekip ayırın. Sonraki adım için tabanı kenara kaldırın.

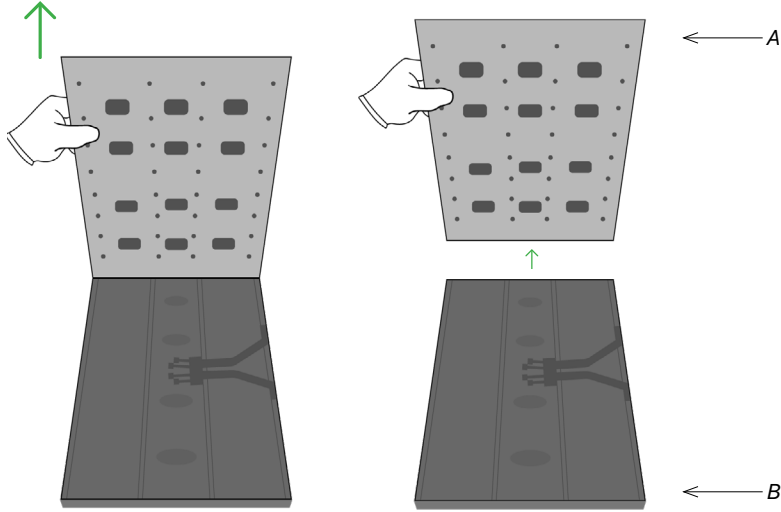

» Yansıtıcıyı sökün.

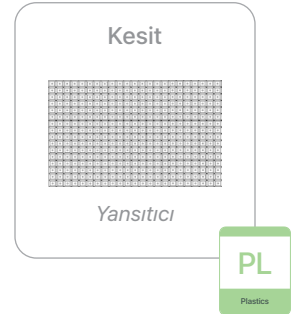
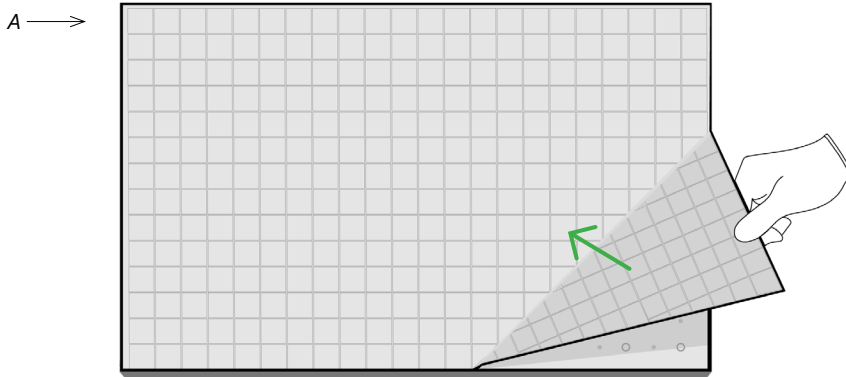

» İki LED dizilimi anakartını sökün.



Kimyasal soluma tehlikesi

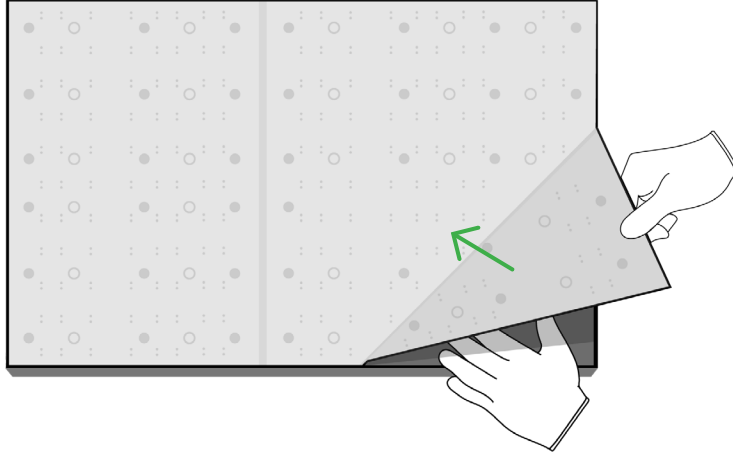

Kesit

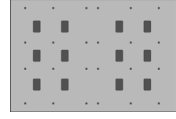

Orta plaka

Al

Aluminum

Kesit

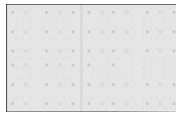

LED dizilimi
anakartı (x2)

PMs

Precious
Metals

6. Toz plakalarını sökün.

» Şerit kabloyu sökün.

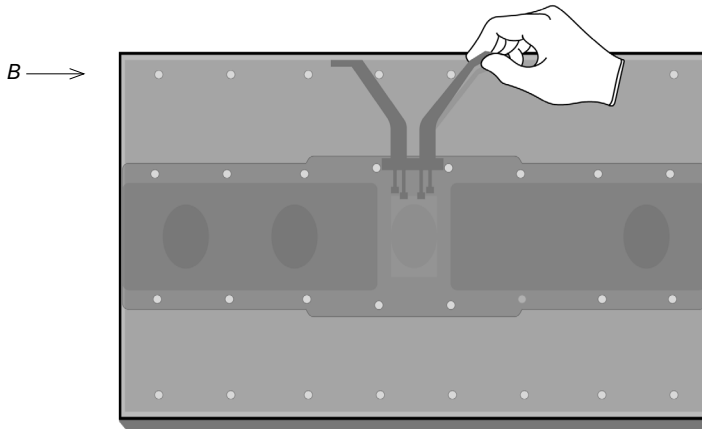

Kullanılan Araçlar

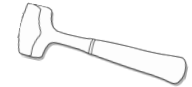

Kesit

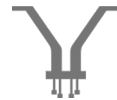

Şerit kablo

Cu

Copper

» Bağlantı elemanlarını sökmek için keskiyi kullanın.



Ellerin zarar görme tehlikesi

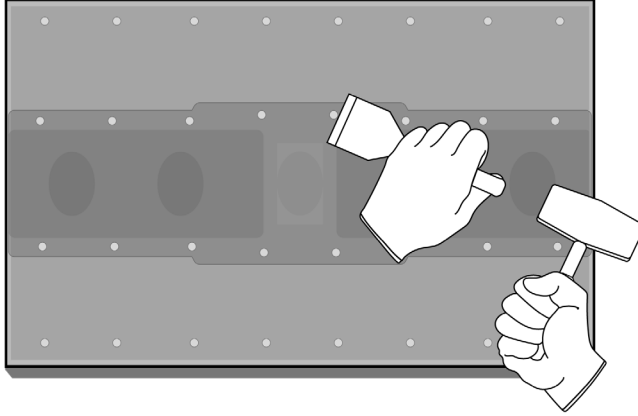

Kesit



Orta toz plakası

Al

Aluminum

Kesit

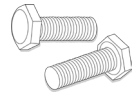

Bağlantı elemanları
(x35)

Fe

Ferrous

» Yandaki toz plakalarını sökün.

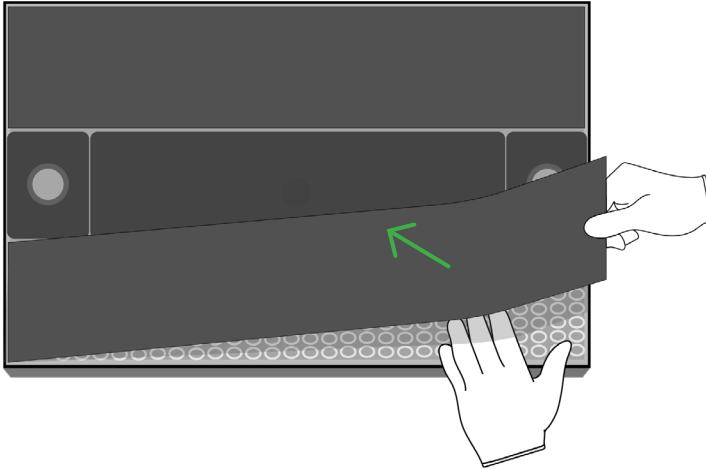

Kesit



Yan toz kapakları

Fe

Ferrous

7. Dört anakartı sökün.

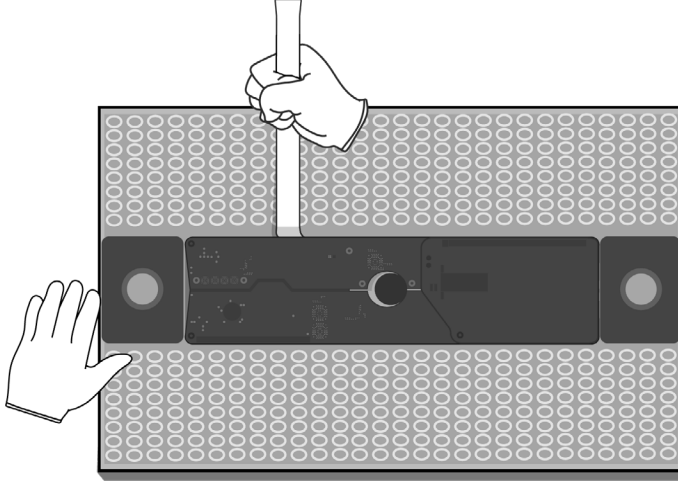

Kullanılan Araçlar



Kesit



Anakart (x4)

PMs
Precious Metals

8. Mıknatısları sökün.

» Ortadaki mıknatısı sökün.

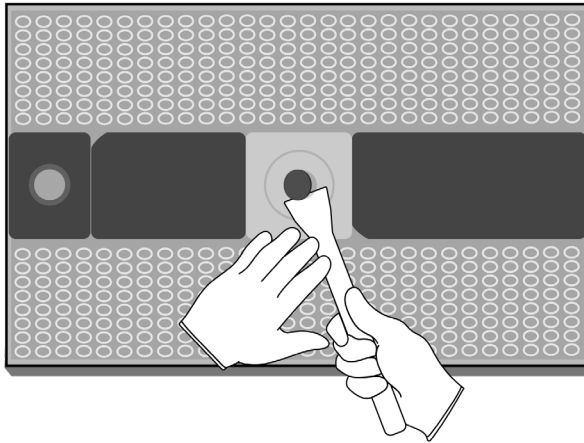

Kullanılan Araçlar

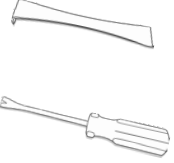

Kesit

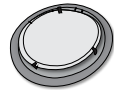

Mıknatıs

REE
Rare Earth Elements

» Yandaki mıknatısları sökün.

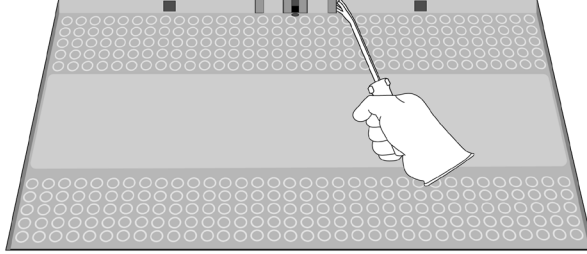

Kesit



Mıknatıslar

REE

Rare Earth
Element

9. Fanları ve AC güç girişini sökün.

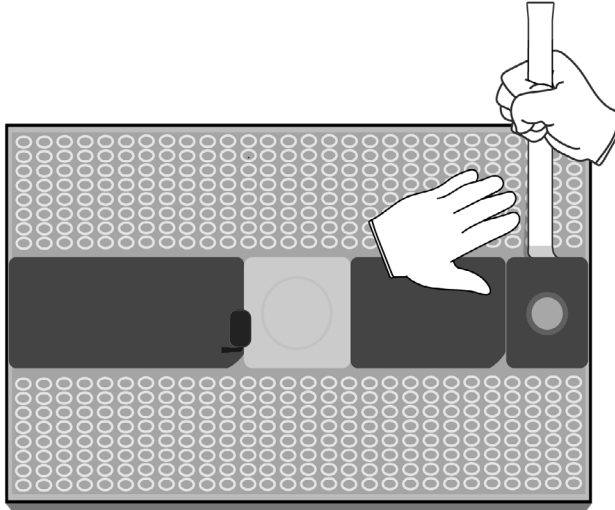

Kullanılan Araçlar



Kesit



Fanlar



AC güç girişi

Cu

Copper

10. Son Őerit kabloları ve diđer kabloları skn.

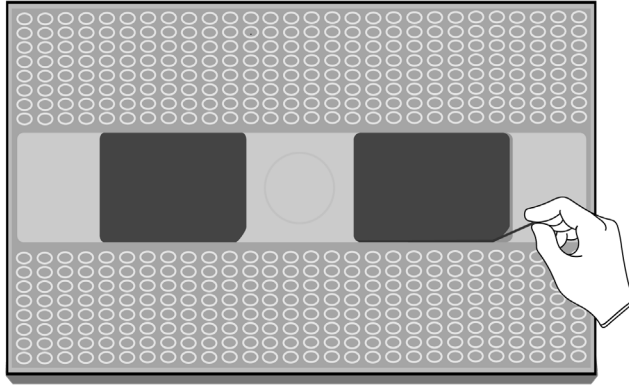
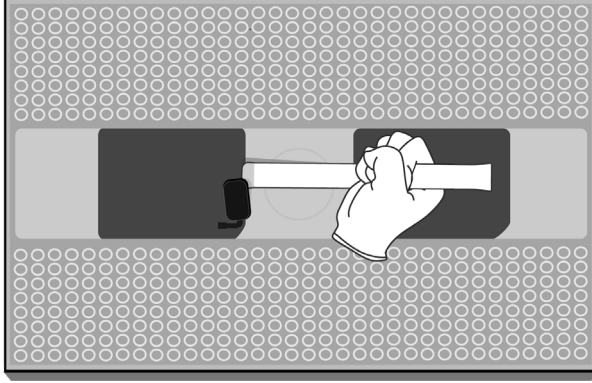

Kullanılan Aralar



Kesit

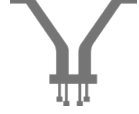

Őerit kablolar
ve diđer kablolar

Cu

Copper

Kesit







Alminyum kasa

Al

Aluminum

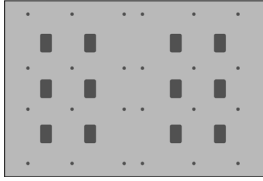
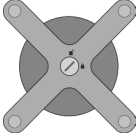
Çıktı Kesitlerinin İşlenmesi

Bu süreçten edinilen tüm çıktılar, Atık Çerçeve Direktifi ve Avrupa'daki ulusal yasalar dahil ancak bunlarla sınırlı olmamakla birlikte ilgili tüm atık yasaları ve düzenlemelerine uygun olarak yönetilmeli, taşınmalı ve imha edilmelidir.

Kesit	Sonraki İşlemler
<p>Alüminyum</p>  <p>Orta toz plakası</p>  <p>Orta plaka</p>  <p>VESA montaj adaptörü</p>  <p>Pro Stand</p>  <p>Alüminyum kasa</p>	<p>Birincil Hedef Malzeme</p>  <p>Alüminyum</p> <p>Potansiyel Ek Malzemeler</p>  <p>Kuprum</p>

Kesit

Sonraki İşlemler

Anakartlar

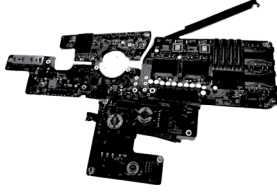

Anakartlar

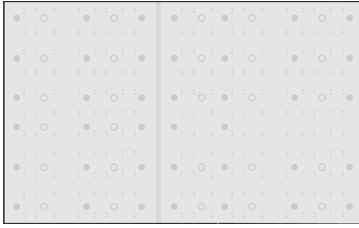

LED dizilimi anakartları



Ekran anakartları

Birincil Hedef Malzeme



Potansiyel Ek Malzemeler



Demir İçeriği



Yan toz plakaları

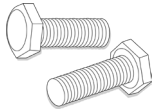

Bağlantı elemanları

Birincil Hedef Malzeme



Kesit

Sonraki İşlemler

Koruyucu Cam ve LCD Hücresi



Koruyucu cam ve LCD hücresi

Birincil Hedef Malzeme



Potansiyel Ek Malzemeler



Karışık Elektronik Parçalar



Fanlar ve AC güç girişi

Birincil Hedef Malzeme



Potansiyel Ek Malzemeler

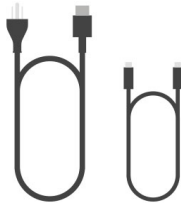

Kablolar

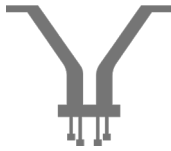

Şerit kablolar

Kesit

Sonraki İşlemler

Karışık Plastik Malzemeler

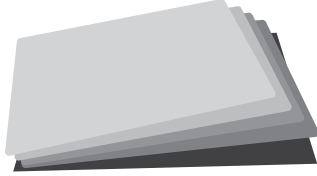

Filmler

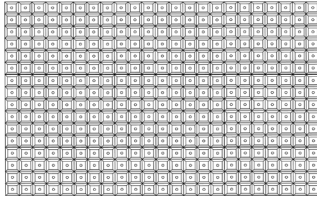

Yansıtıcı

Birincil Hedef Malzeme



Az Bulunur Toprak Miknatısları

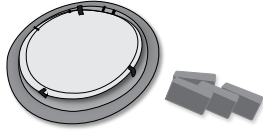

Miknatıslar

Birincil Hedef Malzeme

