



iMac (21.5-inch, 2017)

iMac (Retina 4K, 21.5-inch, 2017)

iMac (Retina 4K, 21.5-inch, 2019)

Apple Recycler Guide

July 2023

Contents

- 3 [About This Guide](#)
- 4 [Identification](#)
- 5 [Directive 2012/19/EU Annex VII Components](#)
- 6 [Safety Considerations](#)
- 7 [Recommended Tools](#)
- 8 [Disassembly Instructions](#)
- 31 [Material Categorization of Output Fractions](#)

About This Guide

Apple Recycler Guides provide guidance for electronics recyclers on how to disassemble products to maximize recovery of resources. The guides provide step-by-step disassembly instructions and information on the material composition to help recyclers direct fractions to the appropriate material recycler.

To conserve important resources, we work to reduce the materials we use and aim to one day source only recycled or renewable materials in our products. A key path to reaching that goal is resource recovery from end-of-life electronics.

Disassembly procedures are intended to be performed only by trained electronics recycling professionals. The recycler is responsible for independently evaluating and ensuring compliance with all applicable environmental, health, and safety laws related to the work. These include but are not limited to laws relating to the management, handling, shipping, and disposal of the outputs of this work as waste and laws in place to ensure the health and safety of all employees who support this work.

For questions or feedback about this guide, email contactesci@apple.com.

Note: This guide may show images from other similar models, but the procedures are the same.

Identification

You can find the model number of the iMac on the bottom of the stand.



*Model numbers:
A1418, A2116*

Directive 2012/19/EU Annex VII Components

Directive 2012/19/EU Annex VII requirements apply to the following substances and components.

Substance/Component	Apple Part Name	Removal Instructions
Printed circuit board if the surface is greater than 10 square centimeters	Display logic board, hard drive, power supply logic board, main logic board	Follow steps 1–18
External electric cables	Power cord	Follow step 1
Battery	Coin cell battery	Follow steps 1–18
Cover glass and liquid crystal display (LCD) cell if the surface is greater than 100 square centimeters	LCD cell	Follow steps 1–7
No further substances or components as listed in Annex VII		

Safety Considerations

The recycler is responsible for independently evaluating all activities undertaken by its employees to perform or support the work and ensuring compliance with all applicable health and safety laws related to the work. These include but are not limited to laws relating to the health and safety of all employees who perform or support this work. The recycler is also responsible for evaluating the workspace and ensuring that the area in which the work is to be undertaken is designed using ergonomic best practices and meets all ergonomic requirements to ensure the protection of its employees.

Personal Protective Equipment

Personal protective equipment should be worn during the entire recycling process.



Wear hand protection



Wear a mask



Wear eye protection



Wear foot protection



Wear protective clothing

LED Safety

Broken light-emitting diodes (LEDs) must be handled properly to ensure the safety of your employees and mitigate any hazards. Package broken LEDs in an appropriate container to properly manage the hazards associated with the materials and store only with compatible materials. All waste must be properly classified, packaged, and labeled in accordance with all relevant laws and regulations.

Hazard Warnings



Broken glass hazard



Chemical inhalation hazard



Chemical exposure hazard

Recommended Tools

Nail-pulling screwdriver

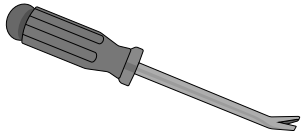

Phillips screwdriver

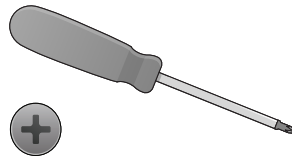

Screwdriver-handle pry bar

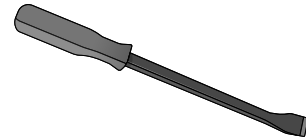

Torx T8 screwdriver

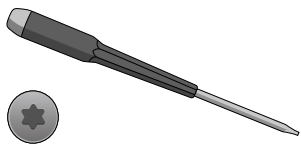

Wire cutters

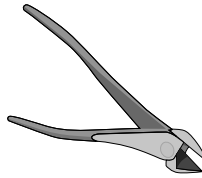

Disassembly Instructions

1. Remove the power cord.

» *Ensure that the iMac is turned off.*



» *Unplug the power cord from the back of the iMac.*

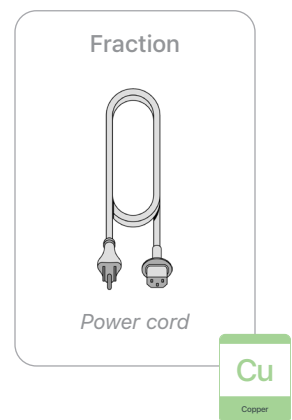
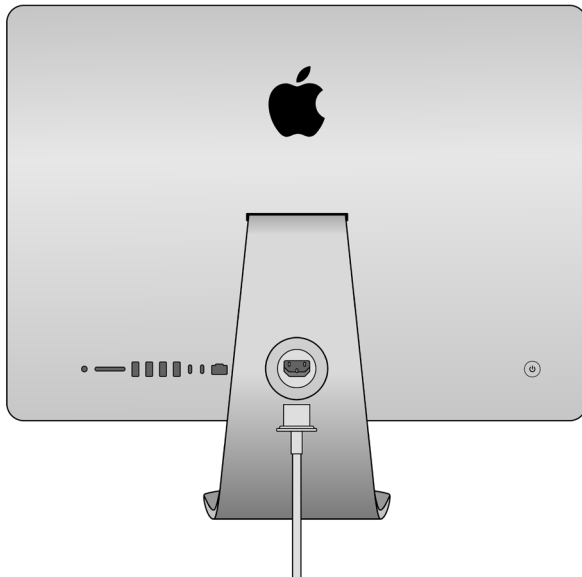

Warning: Before continuing disassembly, wait 10 minutes after unplugging the device for stored energy to discharge.

2. Pry the display away from the housing.



Broken glass hazard

Tools Used

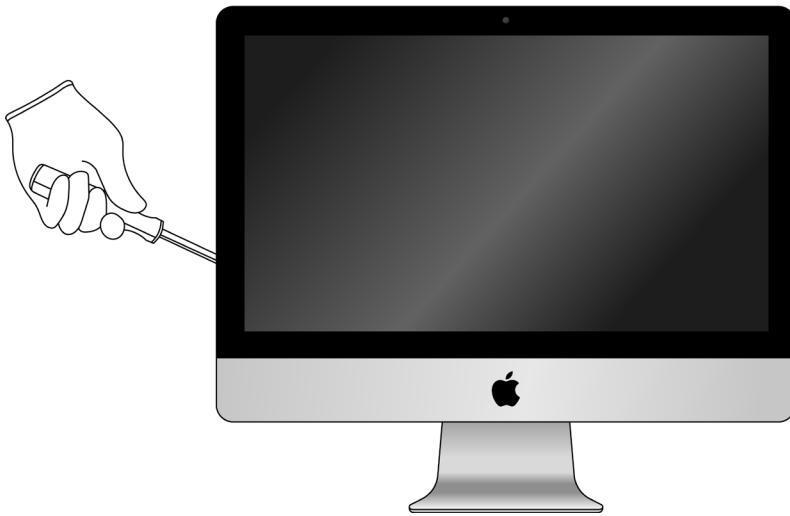
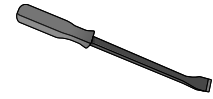

3. Separate the display from the housing.

» *Disconnect the wires.*

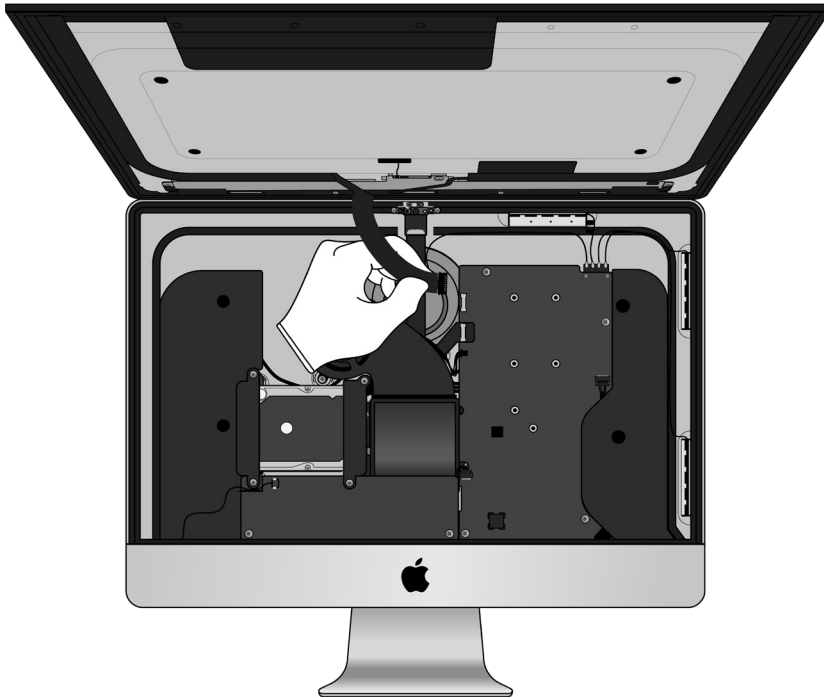

» *Lay the display facedown. Set the housing aside.*

4. Pull the ribbon cables off the back of the display.

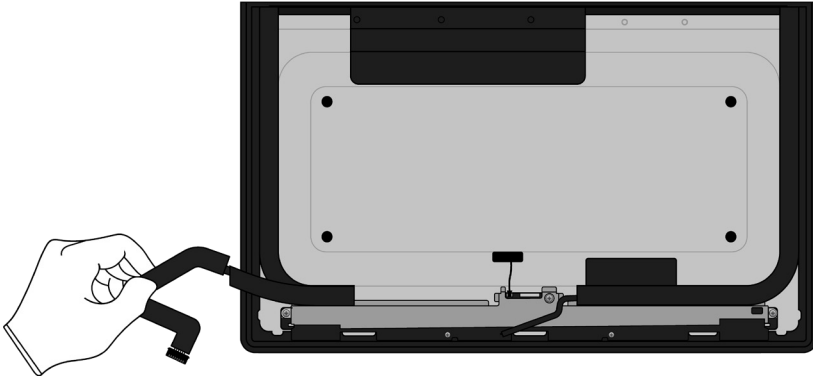

Fraction



Ribbon cables

Cu
Copper

A diagram showing a hand pulling a ribbon cable from a U-shaped frame. Below the diagram is a green box containing the chemical symbol 'Cu' and the word 'Copper'.

5. Pry off the logic board cover.

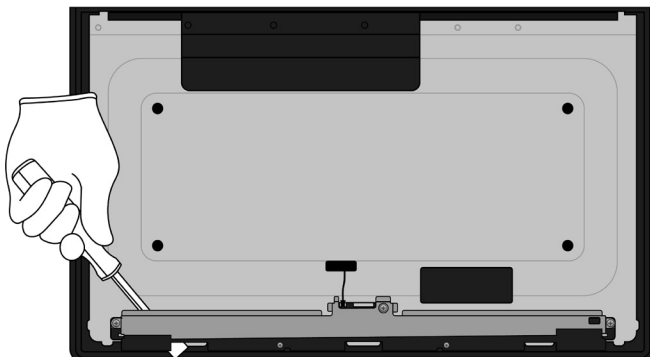

Tools Used

A simple line drawing of a screwdriver with a handle and a flat tip.

Fraction



Logic board cover

Fe
Ferrous

A diagram showing a long, thin metal cover with several small components attached. Below the diagram is a green box containing the chemical symbol 'Fe' and the word 'Ferrous'.

6. Pull off the display logic board.

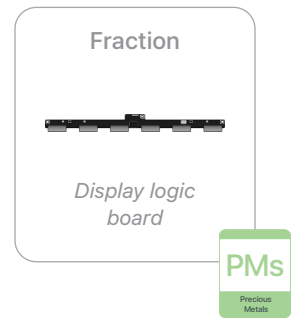
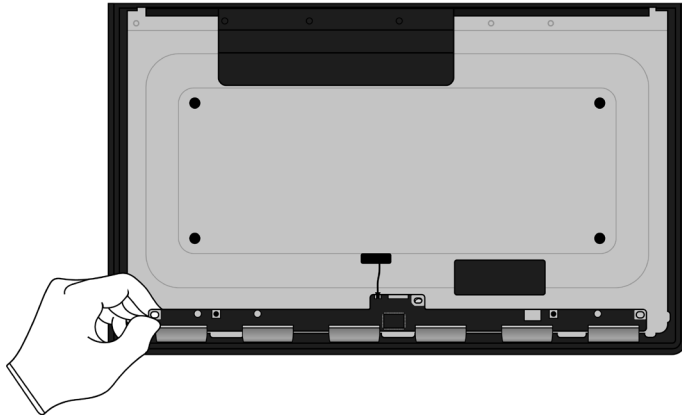

7. Remove the LCD cell and display films.

- » *Pry the LCD cell and display films away from the mid plate. Set the mid plate aside.*

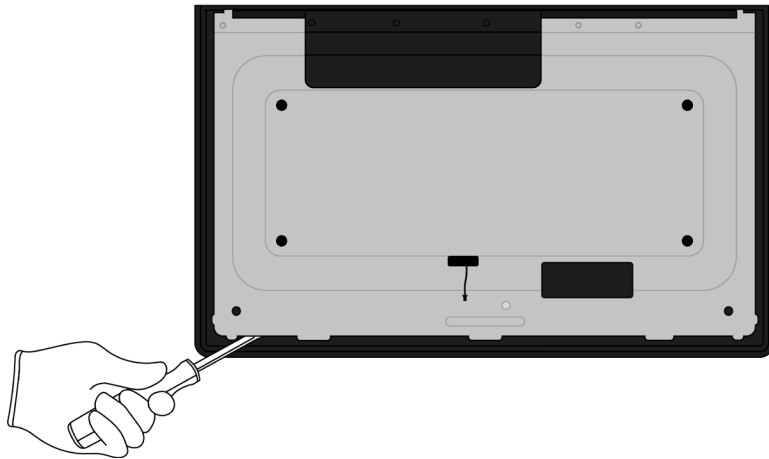
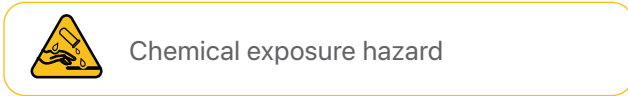

- » *Lift the display films away from the LCD cell by hand.*

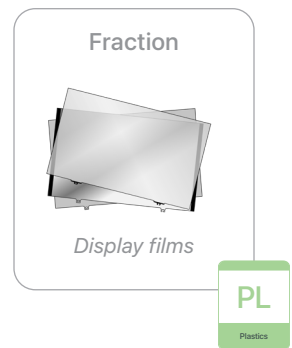
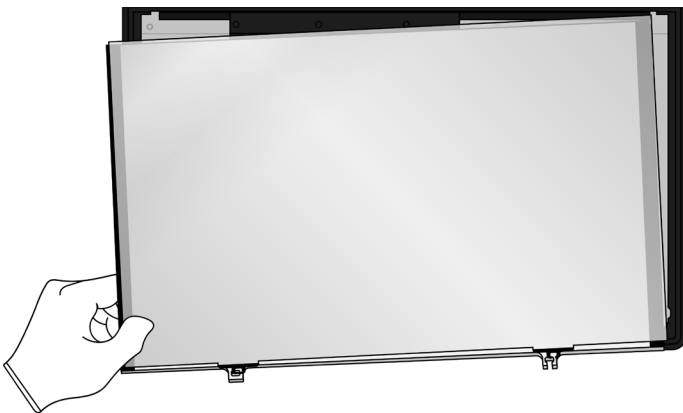

8. On the mid plate, remove the LED logic board by unscrewing the 28 Phillips fasteners. Pull off the LED back strip.

 Chemical inhalation hazard

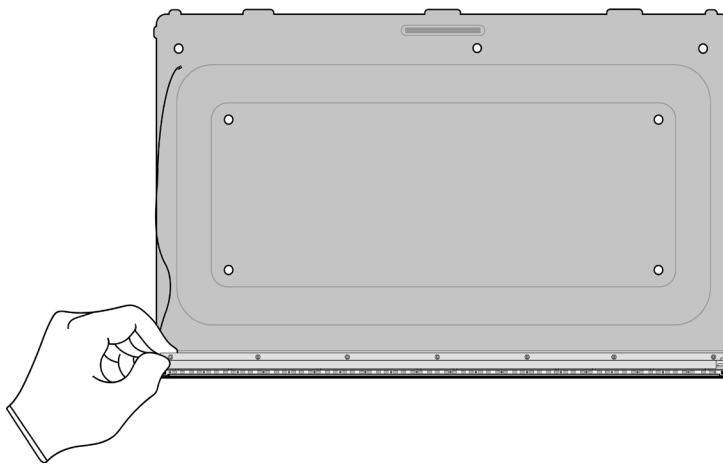
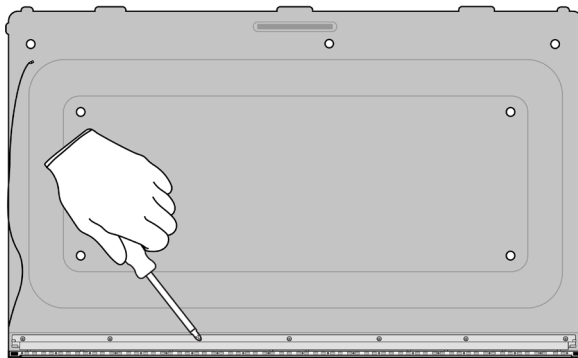

Tools Used



Fraction



Fasteners (x28)

Fe
Ferrous

Fraction



LED back strip

PL
Plastics

Fraction



LED logic board

PMs
Precious Metals

9. Flip over the mid plate and pull off the flex cable.

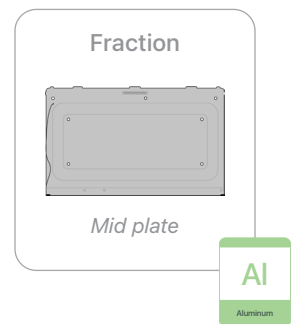
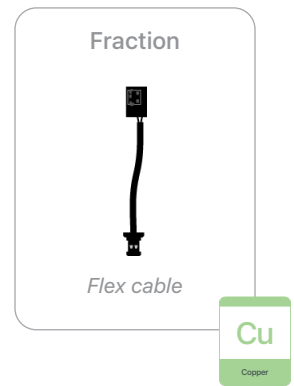
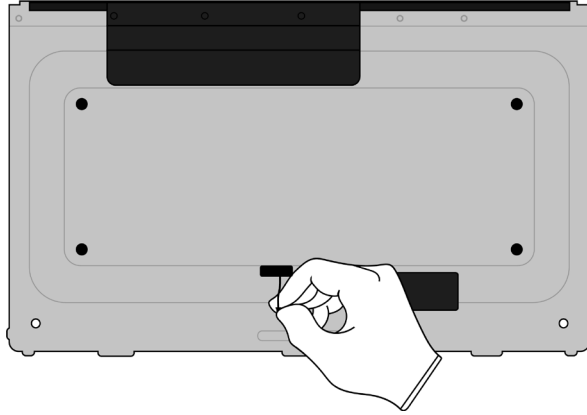

10. Pry off the left speaker. Cut the connector.

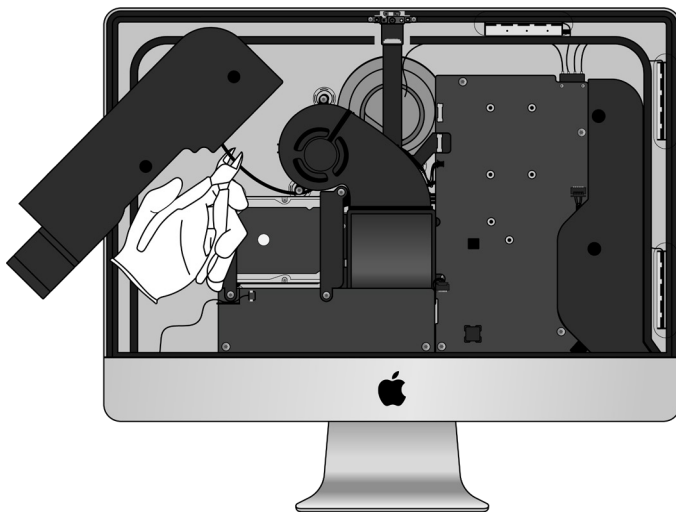
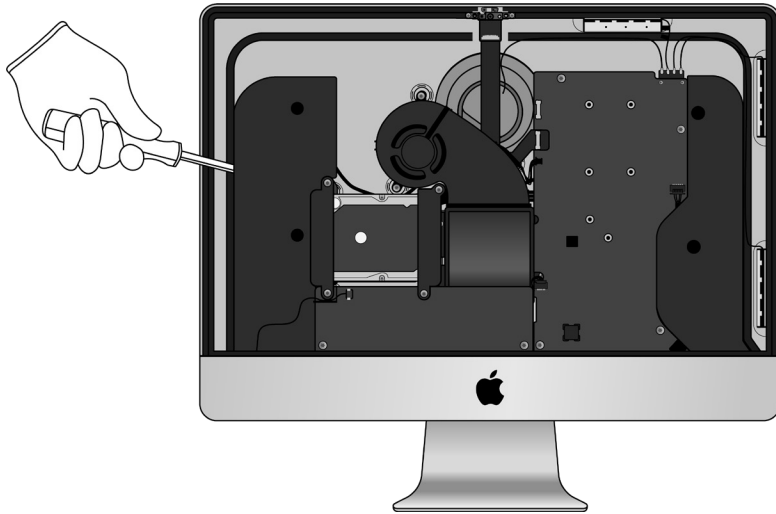

Tools Used

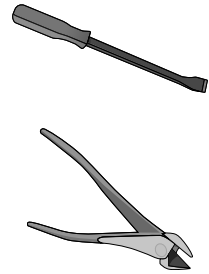

Fraction



Left speaker

REE

Rare Earth
Elements

11. Pry off the hard drive brackets.

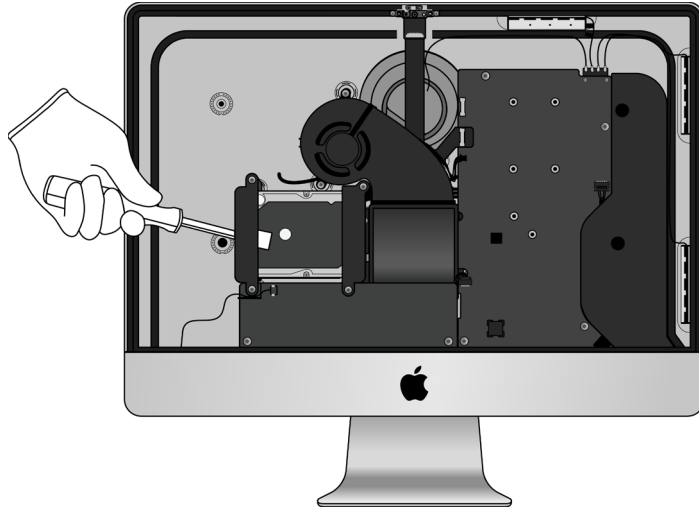

Tools Used

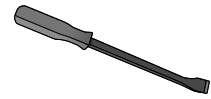

Fraction



Hard drive brackets

PL

Plastics

12. Remove the hard drive by unplugging it from the connector.

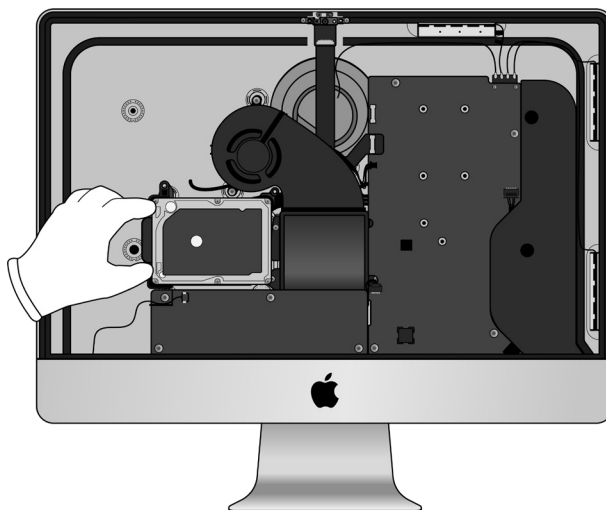

Fraction

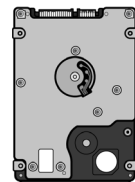

Hard drive

HDD

Hard Disk Drives

13. Pry off the remaining hard drive mounting bracket.

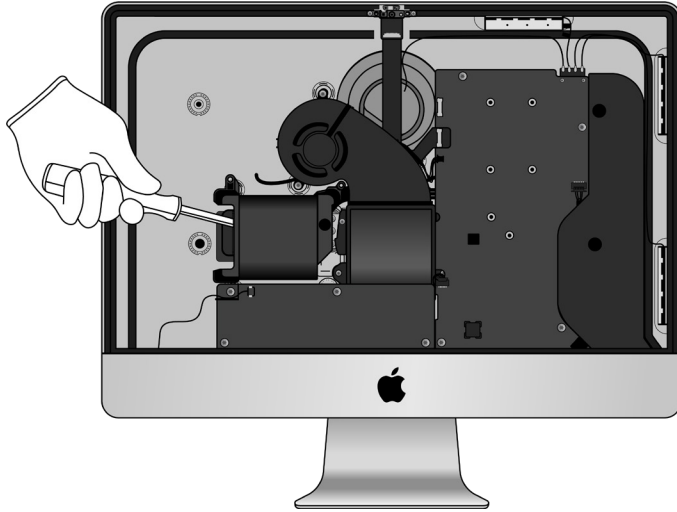

Tools Used

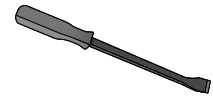

Fraction

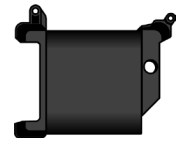

Hard drive mounting bracket

PL

Plastics

14. Pry off the fan.

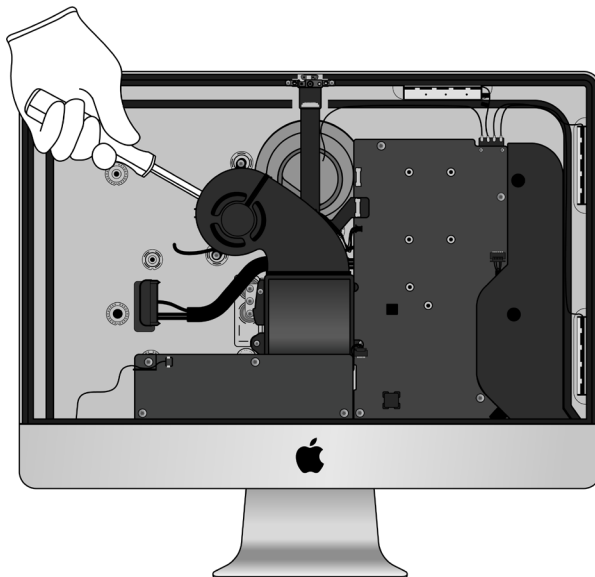

Tools Used

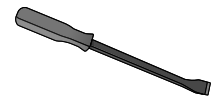

Fraction



Fan

Cu

Copper

15. Remove the power supply logic board.

» Unscrew the four Torx T8 fasteners.

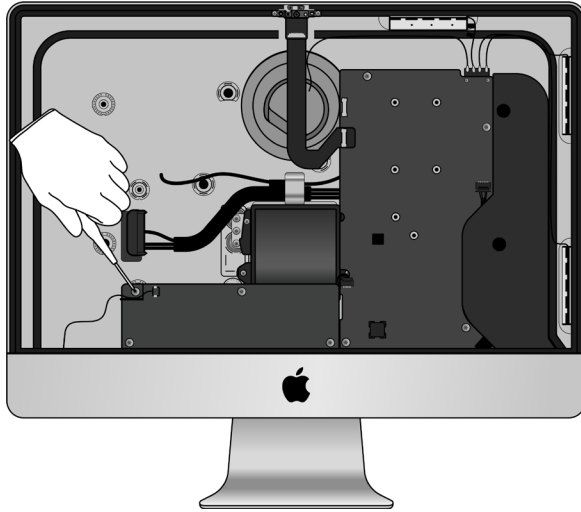

Tools Used

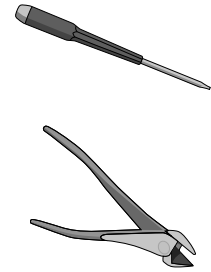

Fraction



Fasteners (x4)

Fe

Ferrous

» Cut off the connectors.

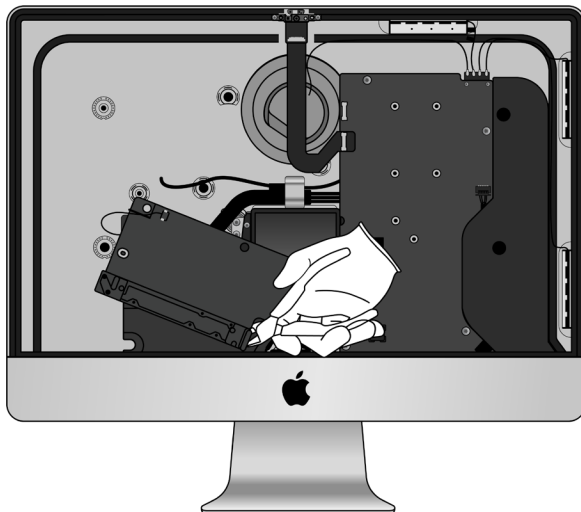

Fraction



Power supply
logic board

PMs

Precious
Metals

16. Pry off the right speaker.

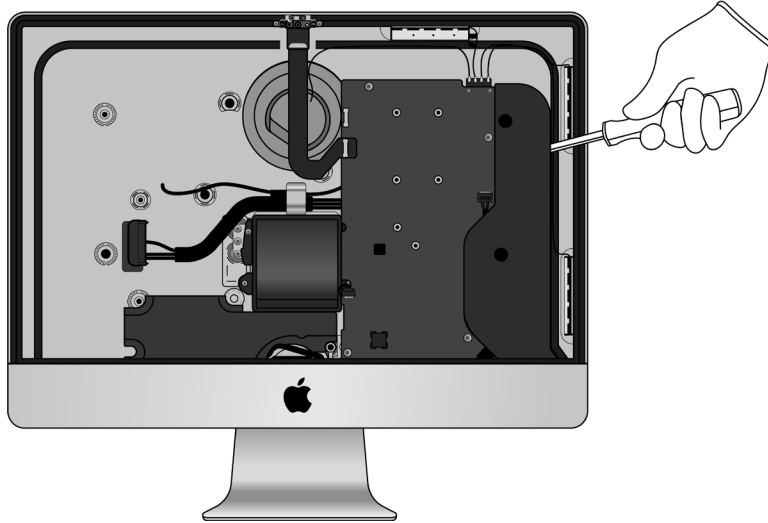

Tools Used

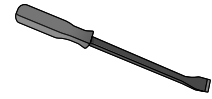

Fraction



Right speaker



17. Remove the main logic board.

» *Pry the main logic board off the housing.*

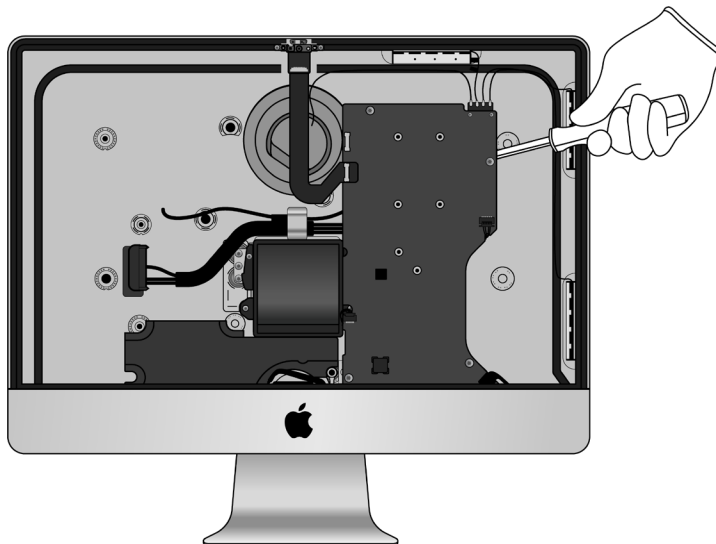

Tools Used

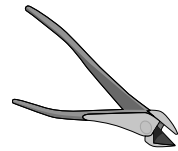
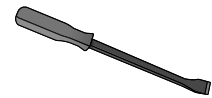

» *Flip over the main logic board and pry off the heat sink.*

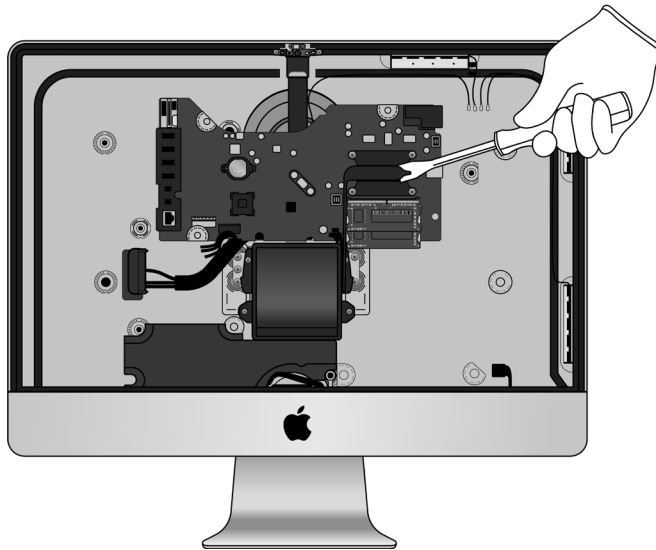

» *Cut the connected wires.*

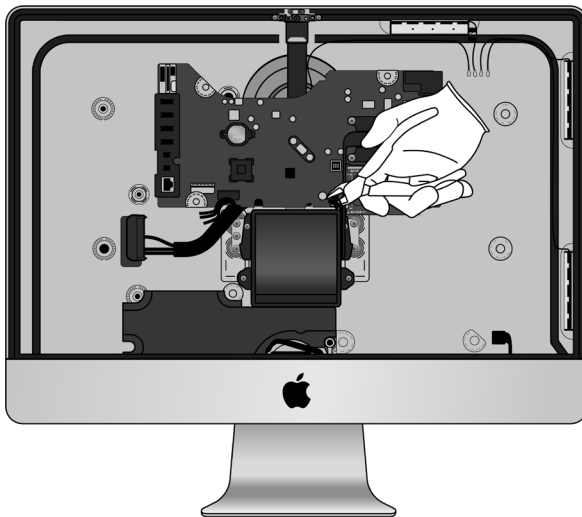

18. Remove the coin cell battery from the main logic board.

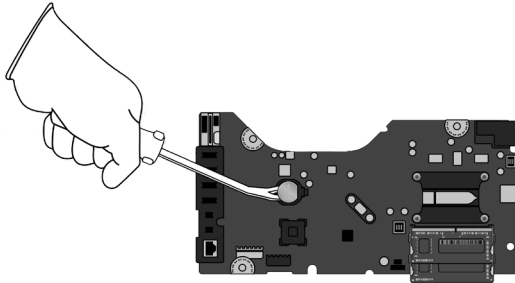

Tools Used

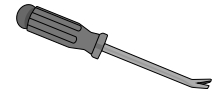

Fraction

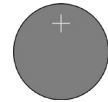

Coin cell battery

BT

Battery

Fraction

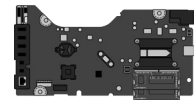

Main logic board

PMs

Precious Metals

- 19.** Remove the heat sink from the housing by unscrewing the four Torx T8 fasteners.

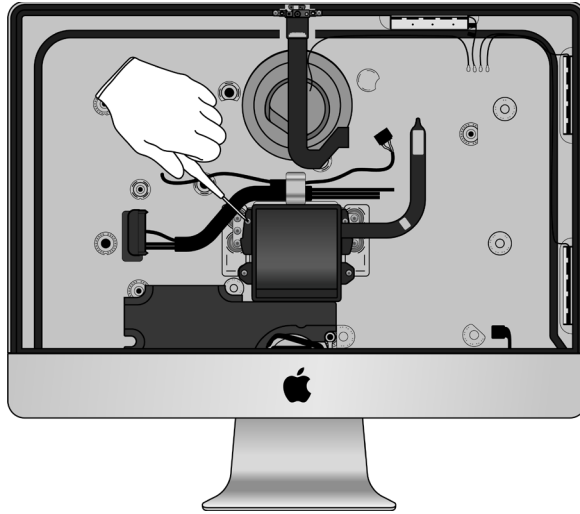

Tools Used

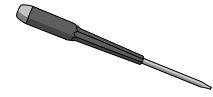

Fraction



Fasteners (x4)

Fe

Ferrous

Fraction

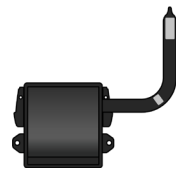

Heat sink

Cu

Copper

20. Remove the camera with logic board.

» Pull off the ribbon cable by hand.

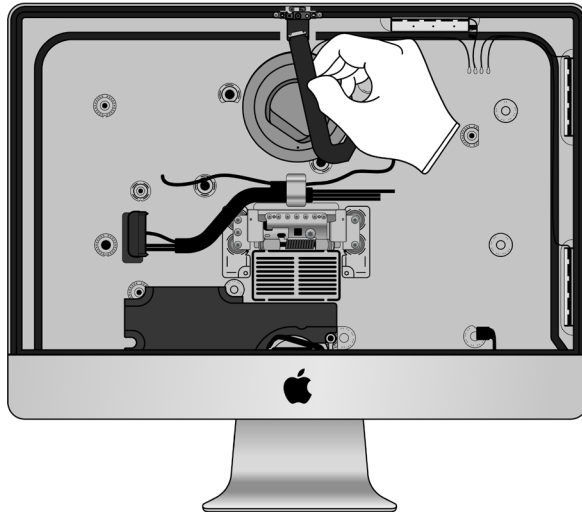

Tools Used

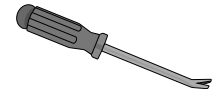

Fraction



Ribbon cable

Cu
Copper

» Pry off the camera with logic board.

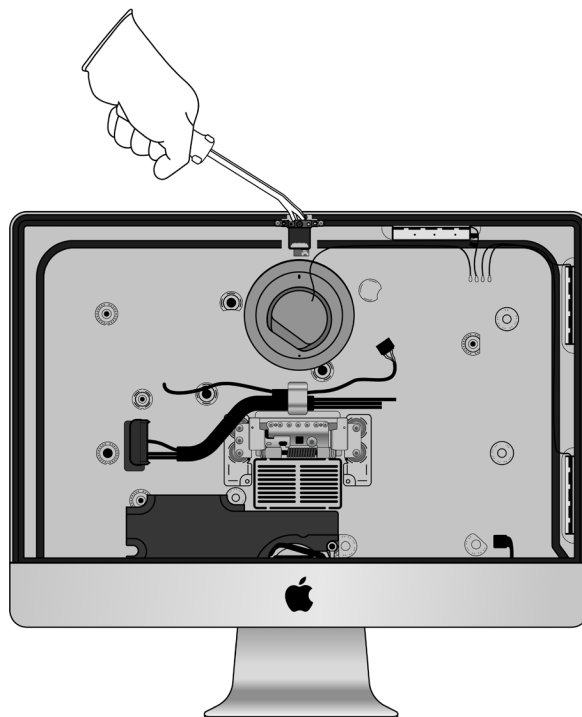

Fraction



Camera with
logic board

PMs
Precious
Metals

21. Pry off the microphone.

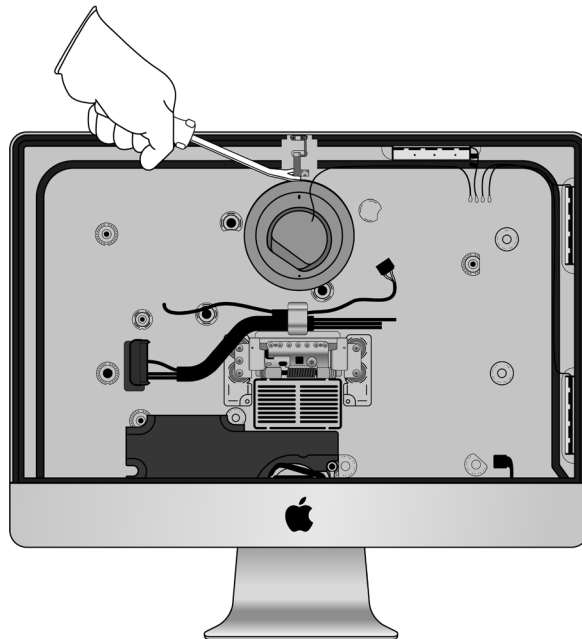

Tools Used

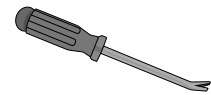

Fraction

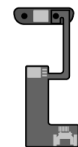

Microphone

Cu
Copper

22. Pull the wires off the wire bracket.

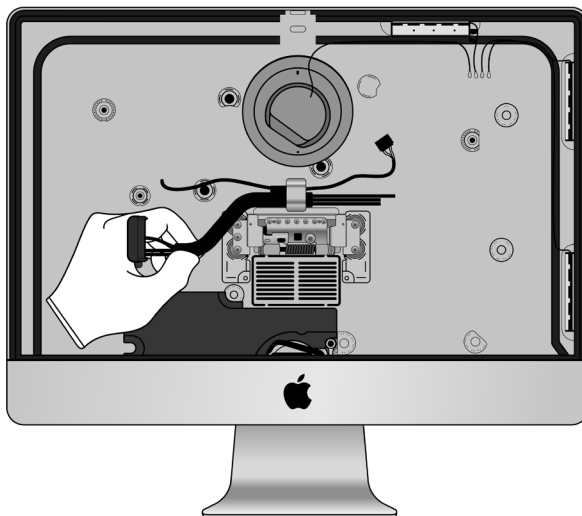

Fraction



Wires

Cu
Copper

23. Pry off the Wi-Fi antennas.

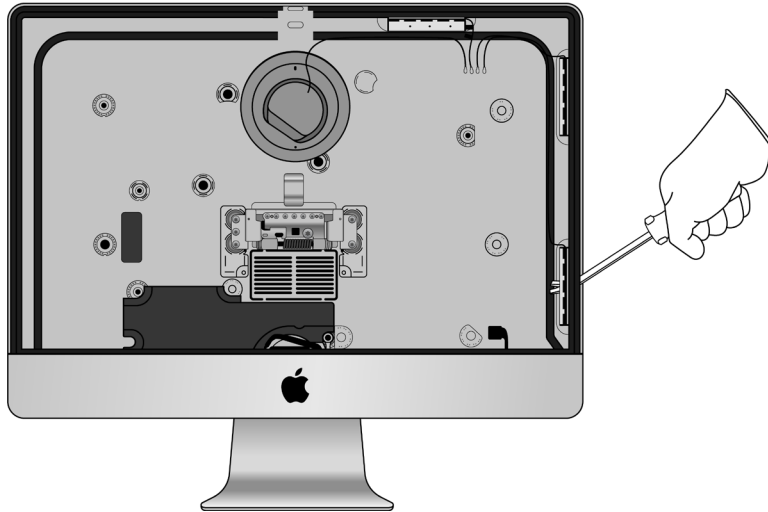

Tools Used

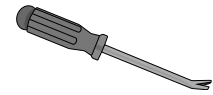

Fraction

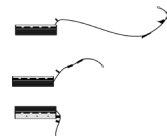

Wi-Fi antennas

Cu

Copper

24. Pry off the Bluetooth antenna.

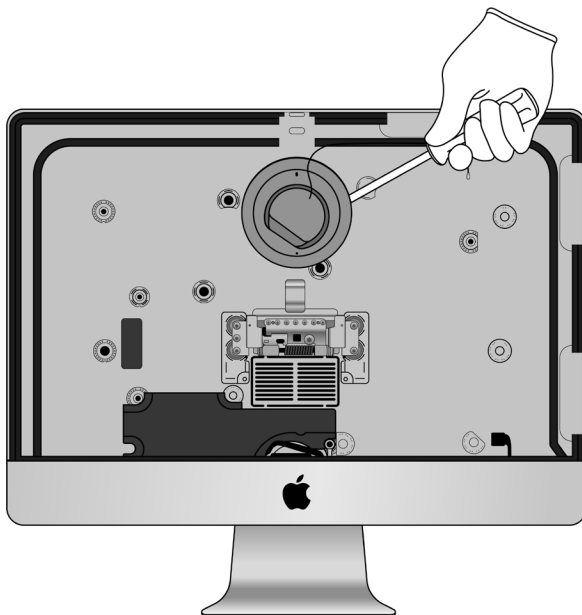

Tools Used

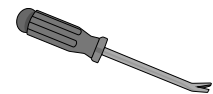

Fraction

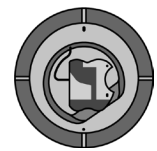

Bluetooth antenna

Cu

Copper

25. Remove the stand by unscrewing the seven Torx T8 fasteners.

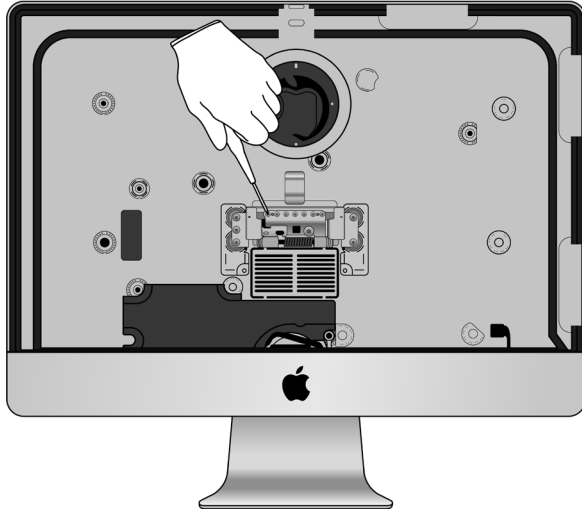

Tools Used

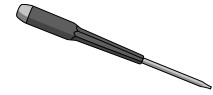

Fraction



Fasteners (x7)

Fe

Ferrous

Fraction

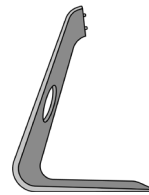

Stand

Al

Aluminum

26. Remove the hinge from the housing by unscrewing the four Torx T8 fasteners.

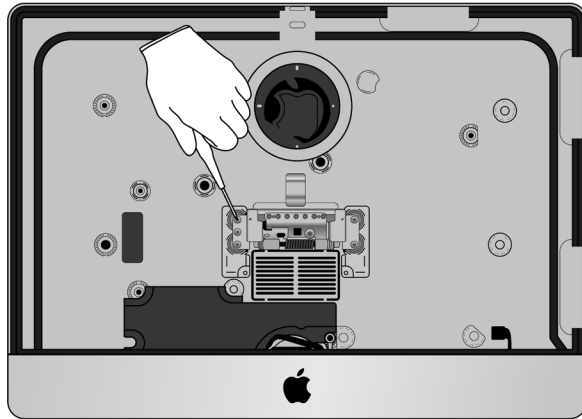

Tools Used

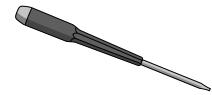

Fraction



Fasteners (x4)

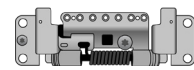

Hinge

Fe

Ferrous

27. Pry off the headphone jack.

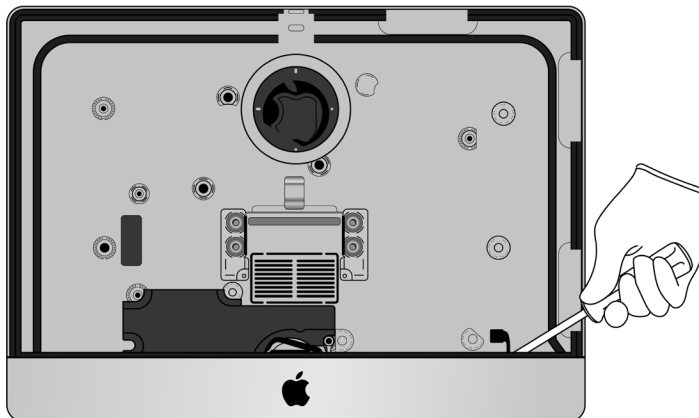

Tools Used

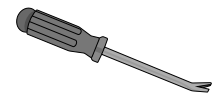

Fraction



Headphone jack

Cu

Copper

28. Pry off the power connector.

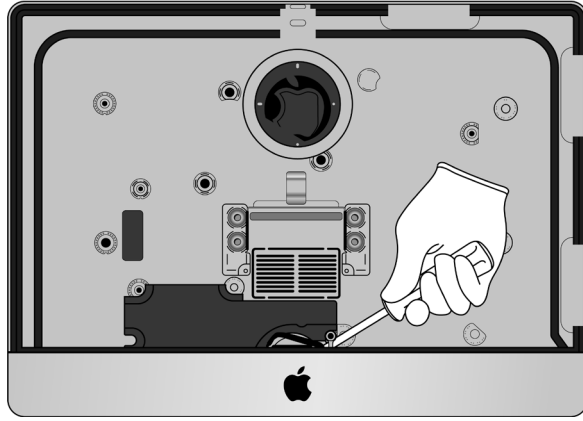

Tools Used

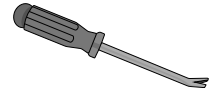

Fraction



Power connector

Cu

Copper

29. Pry off the power button.

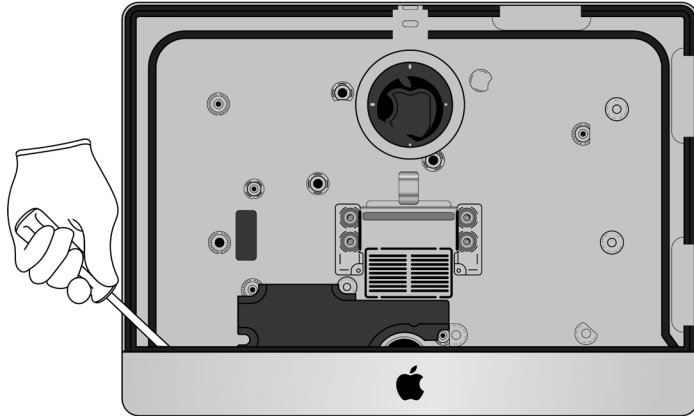

Tools Used

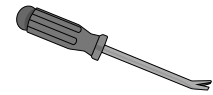

Fraction



Power button

Cu

Copper

Fraction

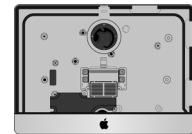





Housing

Al

Aluminum

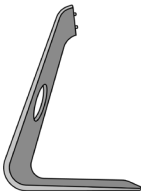
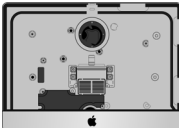
Material Categorization of Output Fractions

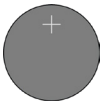
All outputs from this process must be managed, handled, and disposed of in accordance with applicable waste laws and regulations, including but not limited to the Waste Framework Directive and its national enactments in Europe.

Fraction	Downstream Processing
<p data-bbox="435 604 570 632">Aluminum</p>  <p data-bbox="456 804 545 827"><i>Mid plate</i></p>  <p data-bbox="472 1079 529 1102"><i>Stand</i></p>  <p data-bbox="459 1295 542 1318"><i>Housing</i></p>	<p data-bbox="964 604 1273 632">Primary Target Material</p>  <p data-bbox="924 856 1313 884">Potential Additional Materials</p> 
<p data-bbox="440 1415 561 1442">Batteries</p>  <p data-bbox="423 1604 578 1627"><i>Coin cell battery</i></p>	<p data-bbox="964 1415 1273 1442">Primary Target Material</p> 

Fraction	Downstream Processing
----------	-----------------------

Ferrous



Logic board cover



Fasteners (x47)

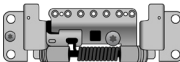

Hinge

Primary Target Material



Glass



LCD cell

Primary Target Material



Potential Additional Materials



Hard Disk Drives

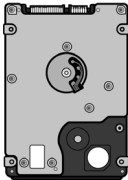

Hard drive

Primary Target Material



Potential Additional Materials



Fraction

Downstream Processing

Logic Boards



Display logic board



LED logic board



Power supply logic board

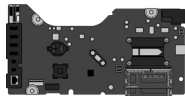

Main logic board



Camera with logic board

Primary Target Material



Potential Additional Materials



Mixed Electronics

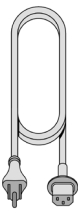

Power cord

Primary Target Material



Potential Additional Materials



Mixed Electronics (cont.)



Ribbon cables



Flex cable

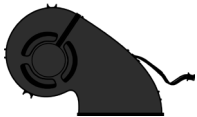

Fan

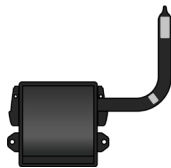

Heat sink

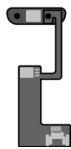

Microphone



Wires

Mixed Electronics (cont.)

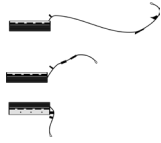

Wi-Fi antennas

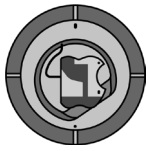

Bluetooth antenna



Headphone jack



Power connector



Power button

Fraction

Downstream Processing

Mixed Plastics



Display films



LED back strip

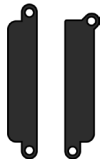

Hard drive brackets

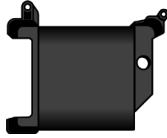

Hard drive mounting bracket

Primary Target Material



Rare Earth Magnets



Left speaker



Right speaker

Primary Target Material



Potential Additional Materials

