



iMac (Retina 5K, 27-inch, 2017)

iMac (Retina 5K, 27-inch, 2019)

iMac (Retina 5K, 27-inch, 2020)

Apple Recycler Guide

July 2023

Contents

- 3 [About This Guide](#)
- 4 [Identification](#)
- 5 [Directive 2012/19/EU Annex VII Components](#)
- 6 [Safety Considerations](#)
- 7 [Recommended Tools](#)
- 8 [Disassembly Instructions](#)
- 32 [Material Categorization of Output Fractions](#)

About This Guide

Apple Recycler Guides provide guidance for electronics recyclers on how to disassemble products to maximize recovery of resources. The guides provide step-by-step disassembly instructions and information on the material composition to help recyclers direct fractions to the appropriate material recycler.

To conserve important resources, we work to reduce the materials we use and aim to one day source only recycled or renewable materials in our products. A key path to reaching that goal is resource recovery from end-of-life electronics.

Disassembly procedures are intended to be performed only by trained electronics recycling professionals. The recycler is responsible for independently evaluating and ensuring compliance with all applicable environmental, health, and safety laws related to the work. These include but are not limited to laws relating to the management, handling, shipping, and disposal of the outputs of this work as waste and laws in place to ensure the health and safety of all employees who support this work.

For questions or feedback about this guide, email contactesci@apple.com.

Note: This guide may show images from other similar models, but the procedures are the same.

Identification

You can find the model number of the iMac on the bottom of the stand.

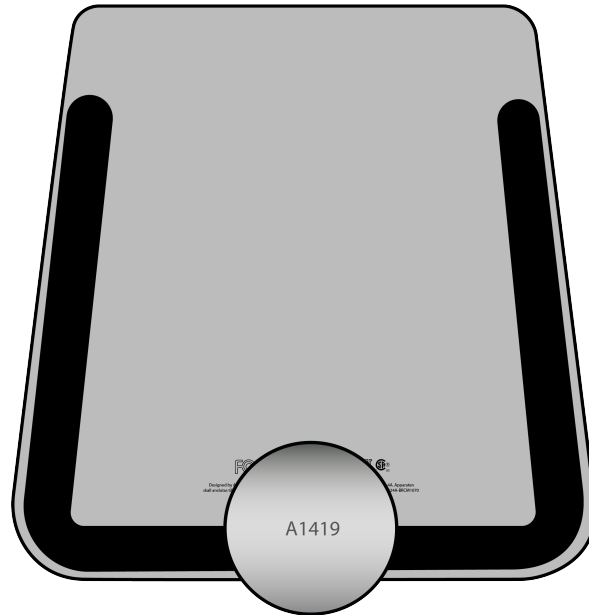

*Model numbers:
A1419, A2115*

Directive 2012/19/EU Annex VII Components

Directive 2012/19/EU Annex VII requirements apply to the following substances and components.

Substance/Component	Apple Part Name	Removal Instructions
Printed circuit board if the surface is greater than 10 square centimeters	Hard drive, display logic board, light-emitting diode (LED) logic board, power supply, main logic board	Follow steps 1–18
External electric cables	Power cord	Follow step 1
Battery	Coin cell battery	Follow steps 1–17
Cover glass and liquid crystal display (LCD) cell if the surface is greater than 100 square centimeters	Display	Follow steps 1–8
No further substances or components as listed in Annex VII		

Safety Considerations

The recycler is responsible for independently evaluating all activities undertaken by its employees to perform or support the work and ensuring compliance with all applicable health and safety laws related to the work. These include but are not limited to laws relating to the health and safety of all employees who perform or support this work. The recycler is also responsible for evaluating the workspace and ensuring that the area in which the work is to be undertaken is designed using ergonomic best practices and meets all ergonomic requirements to ensure the protection of its employees.

Personal Protective Equipment

Personal protective equipment should be worn during the entire recycling process.



Wear hand protection



Wear a mask



Wear eye protection



Wear foot protection



Wear protective clothing

LED Safety

Broken LEDs must be handled properly to ensure the safety of your employees and mitigate any hazards. Package broken LEDs in an appropriate container to properly manage the hazards associated with the materials and store only with compatible materials. All waste must be properly classified, packaged, and labeled in accordance with all relevant laws and regulations.

Hazard Warnings



Broken glass hazard



Chemical inhalation hazard



Chemical exposure hazard

Recommended Tools

Miniature pry bar

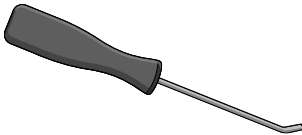

Nail-pulling screwdriver

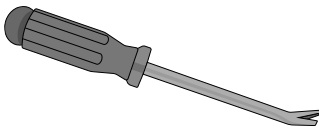

Phillips screwdriver

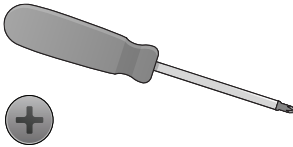

Screwdriver-handle pry bar

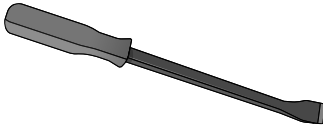

Torx T8 screwdriver

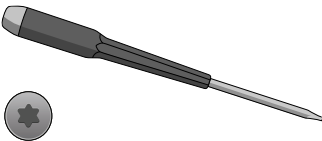

Wire cutters

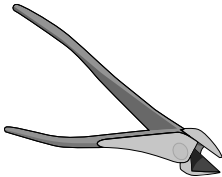

Disassembly Instructions

1. Remove the power cord.

» *Ensure that the iMac is turned off.*



» *Unplug the power cord from the back of the iMac.*

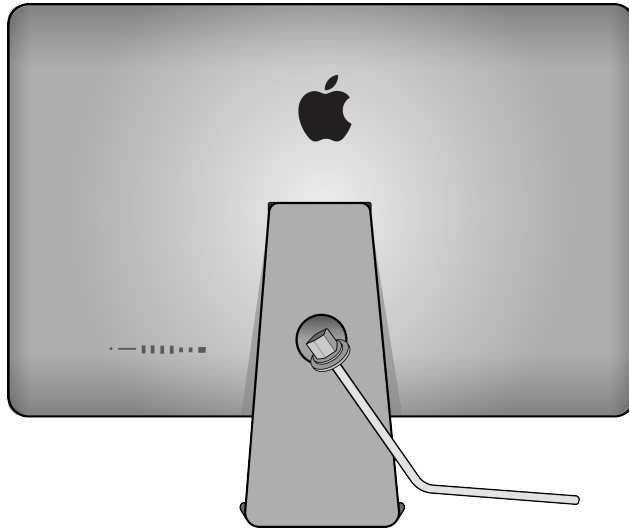

Warning: Before continuing disassembly, wait 10 minutes after unplugging the device for stored energy to discharge.

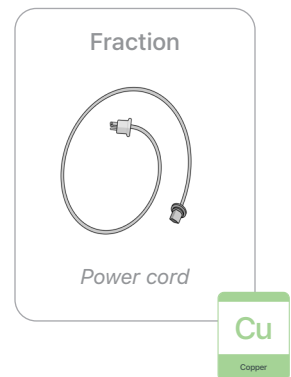

2. Pry the display away from the housing.



Broken glass hazard

Tools Used

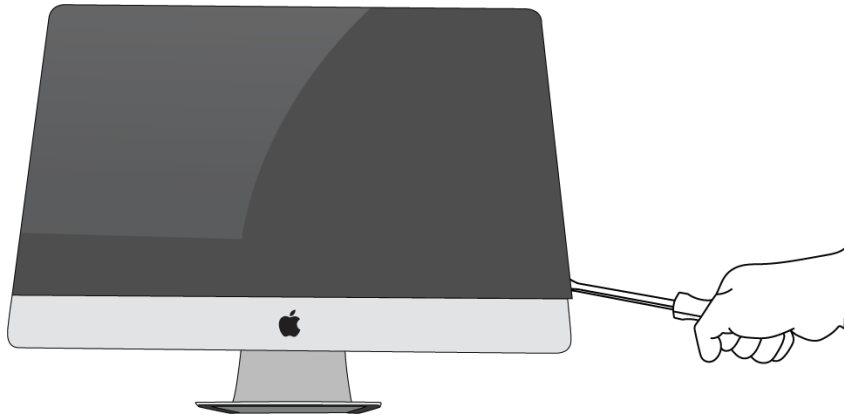
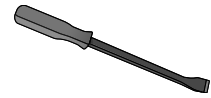

3. Separate the display from the housing.

» *Disconnect the wires by hand.*

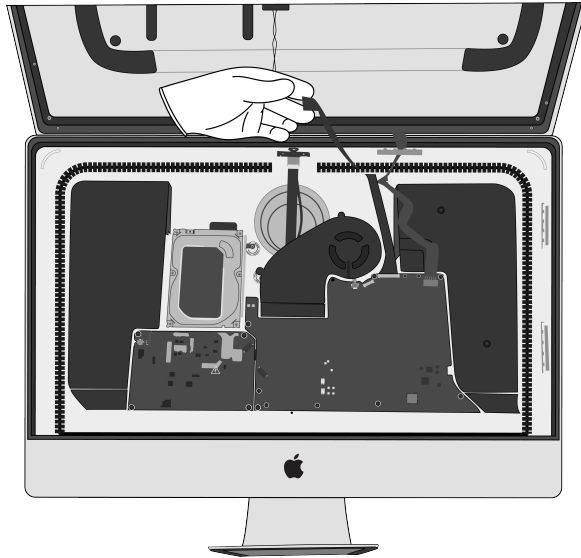

» *Lay the display facedown. Set the housing aside.*

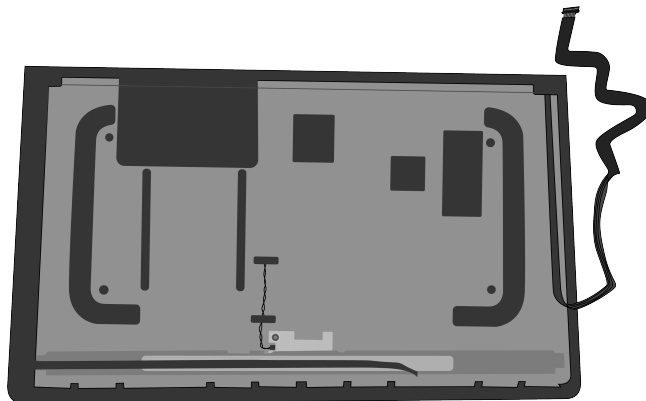

4. Pull the ribbon cables off the back of the display.

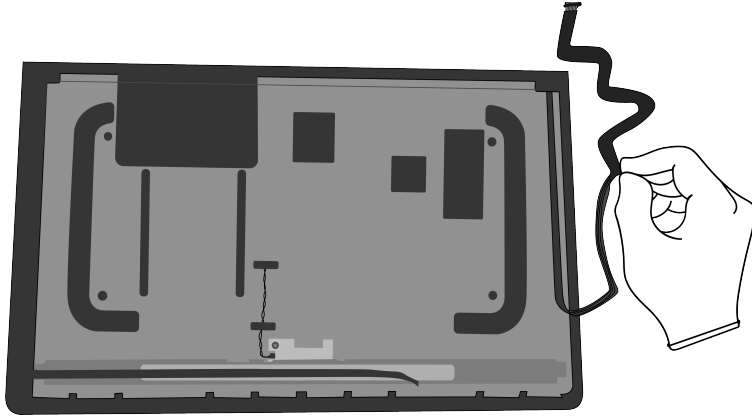

5. Pry off the display logic board cover.

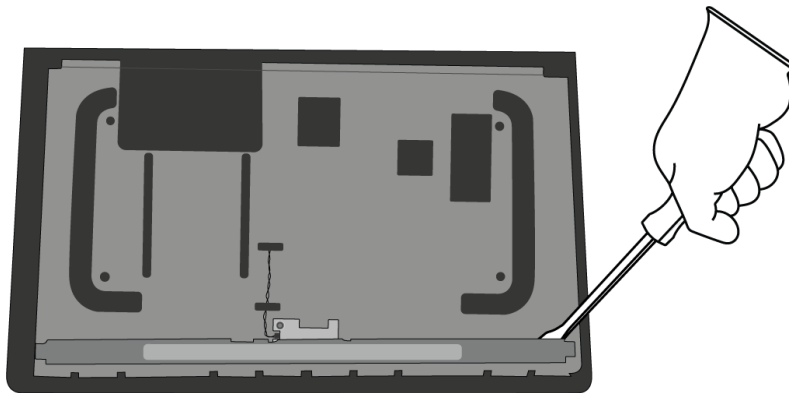

Tools Used



Fraction



Display logic board cover

Fe

Ferrous

6. Pry off the display logic board.

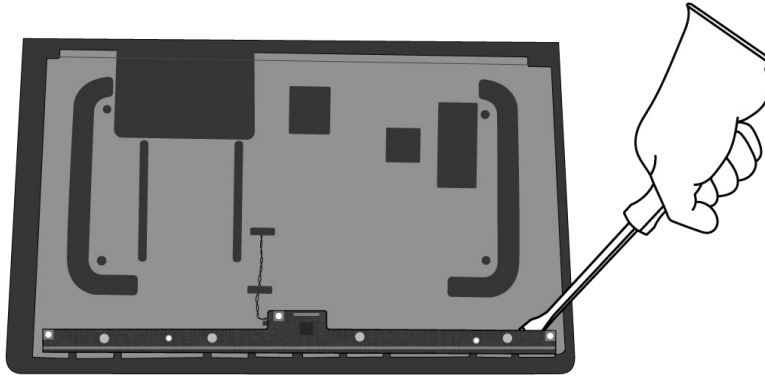

Tools Used

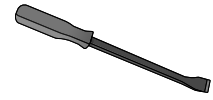

Fraction



Display logic board

PMs
Precious Metals

7. Pull the cable off the display mid plate.

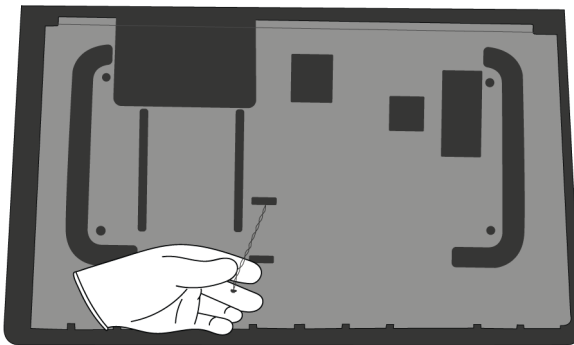

Fraction



Cable

Cu
Copper

8. Remove the LCD cell and display films.

- » *Pry the mid plate off the LCD cell and films. Set the mid plate aside.*

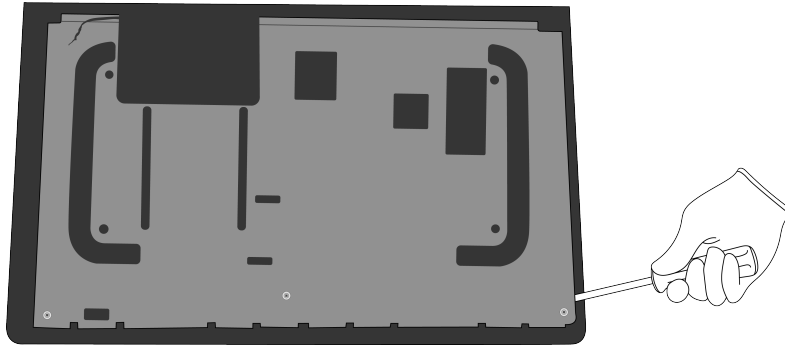

Tools Used



- » *Lift the display films away from the LCD cell.*



Chemical exposure hazard

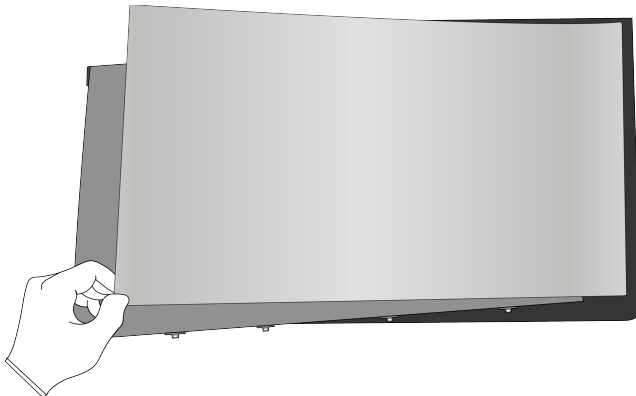

Fraction

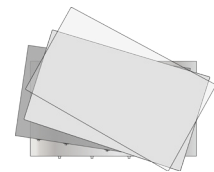

Display films

PL

Plastics

Fraction



LCD cell

GL

Glass

9. On the mid plate, remove the LED logic board.



Chemical inhalation hazard

- » *Unscrew the 16 Phillips fasteners along the length of the LED logic board cover.*

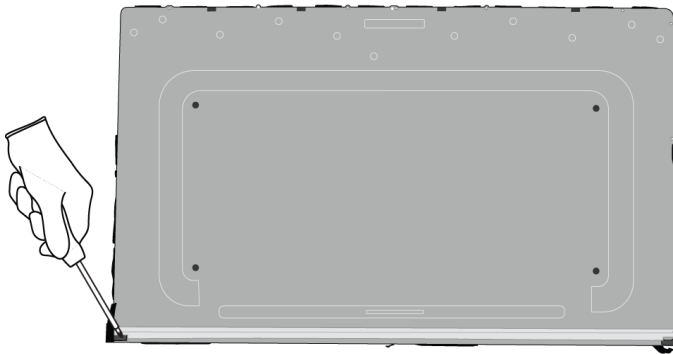

Tools Used

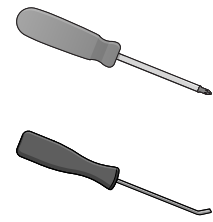

Fraction



Fasteners (x16)

Fe

Ferrous

» Separate the LED cover from the LED logic board using the miniature pry bar.

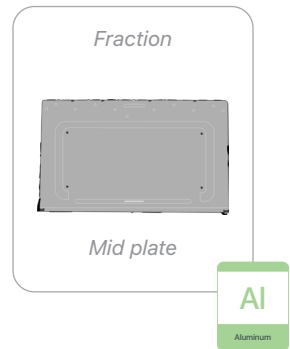
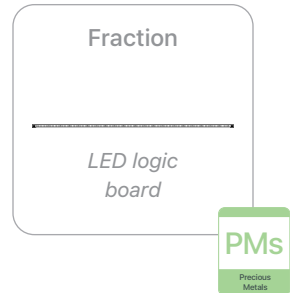
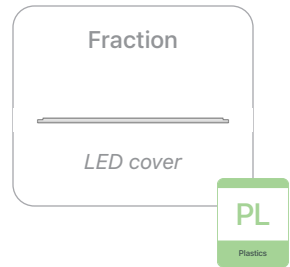
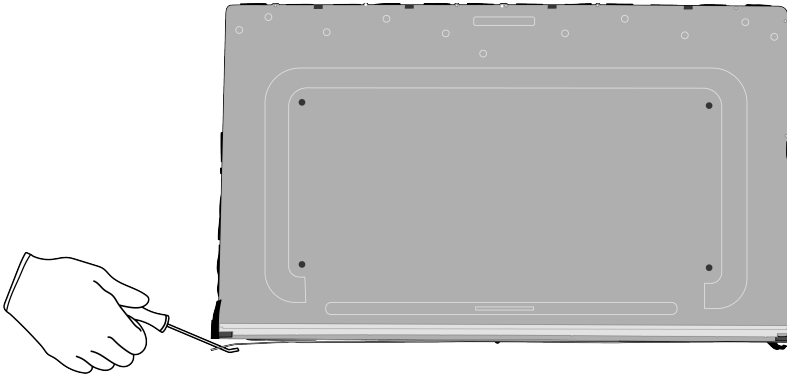

10. Inside the housing, remove the left speaker.

» *Pry off the speaker.*

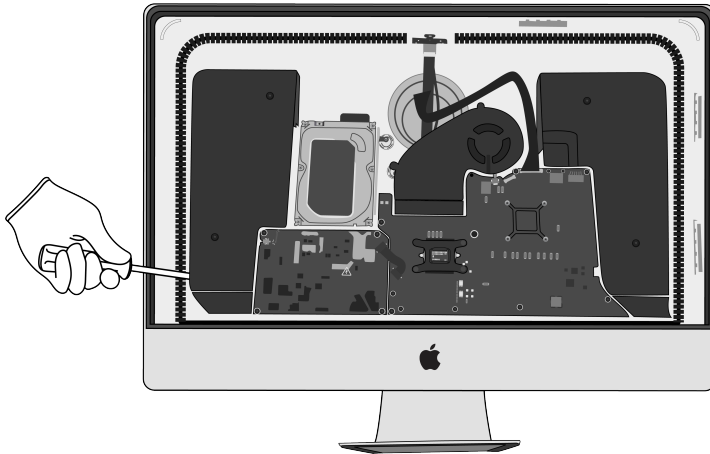

» *Cut the cable that attaches the speaker to the main logic board.*

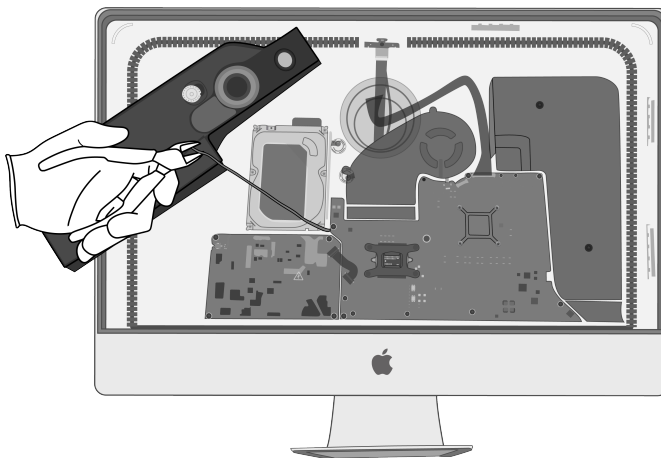

Tools Used

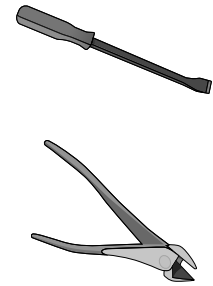

Fraction



Left speaker

REE

Rare Earth
Elements

11. Remove the hard drive.

» *Unplug the hard drive/main logic board connector.*

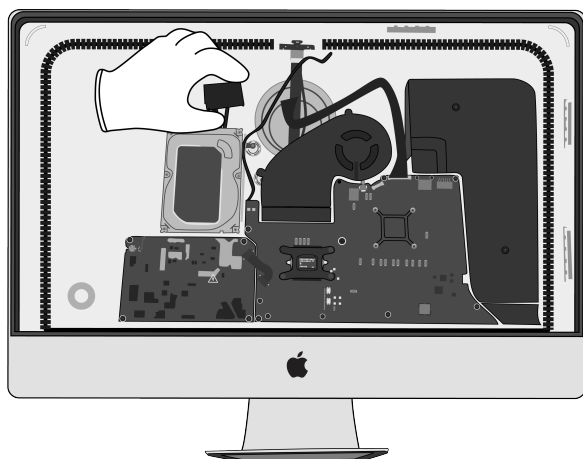

Tools Used

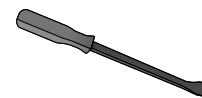

» *Pry the hard drive off the brackets.*

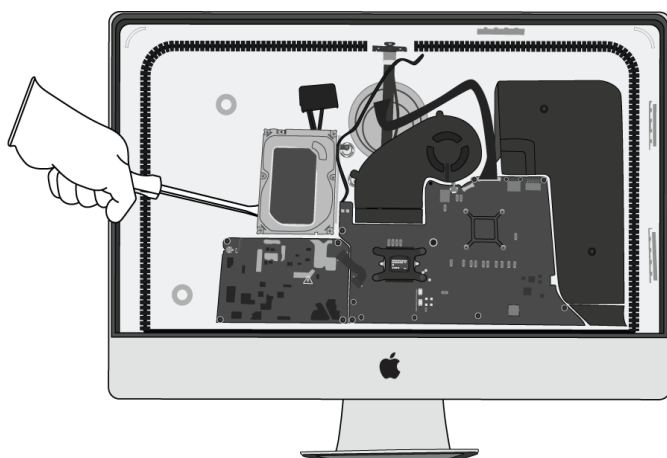

Fraction



Hard drive



12. Remove the hard drive brackets.

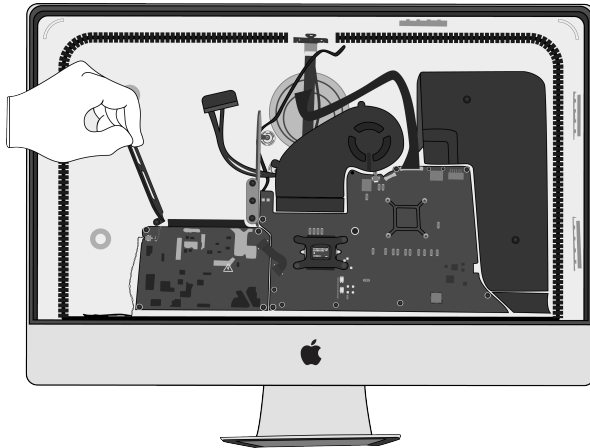

Fraction



Hard drive
brackets

Fe

Ferrous

13. Pry off the fan.

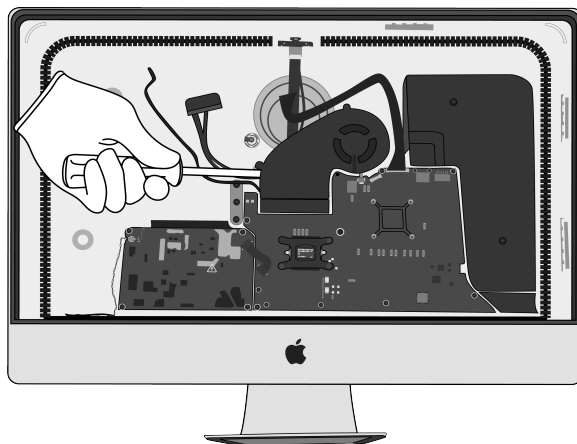

Tools Used

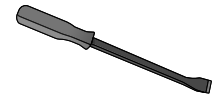

Fraction

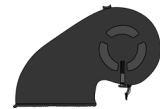

Fan

Cu

Copper

14. Remove the power supply logic board.

» Unscrew the four Torx T8 fasteners.

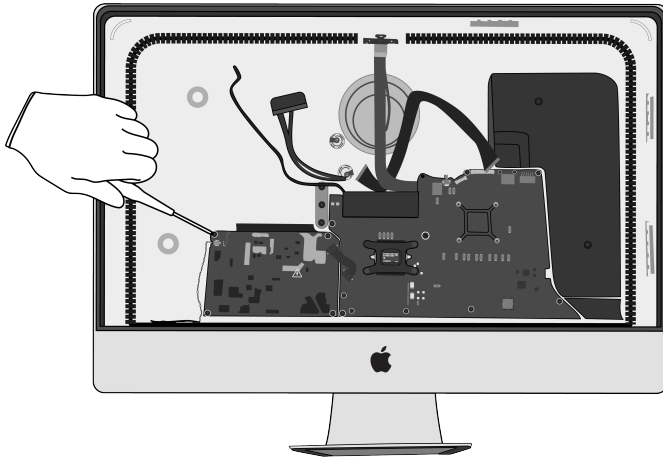

Tools Used

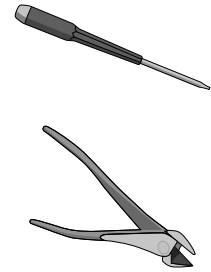

Fraction



Fasteners (x4)

Fe

Ferrous

» Flip over the power supply logic board and cut the two cables.

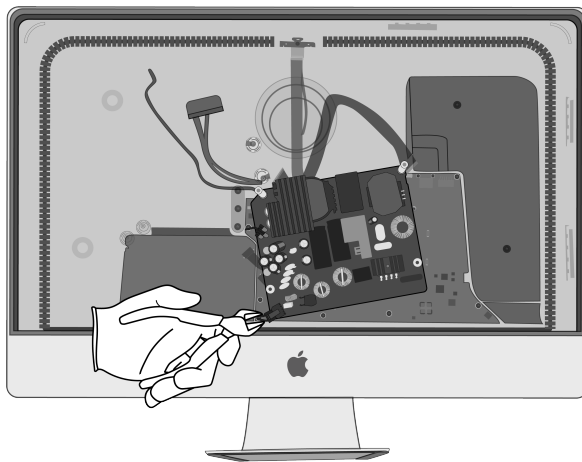

Fraction

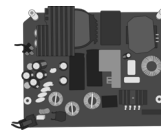

Power supply
logic board

PMs

Precious
Metals

15. Remove the right speaker.

» *Pry off the speaker.*

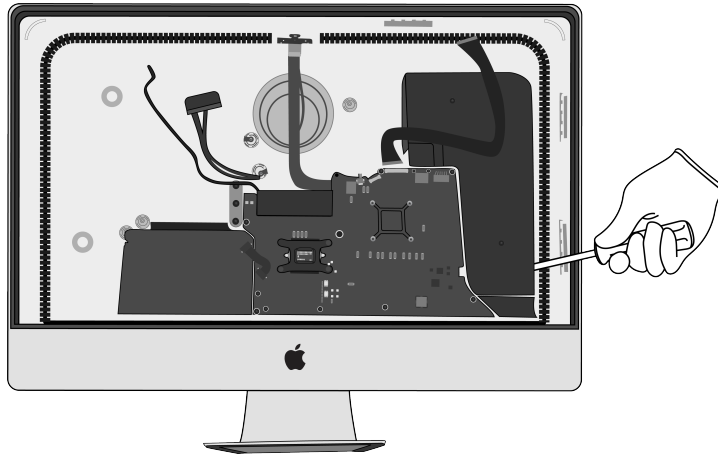

Tools Used



» *Cut the cable that attaches the speaker to the main logic board.*

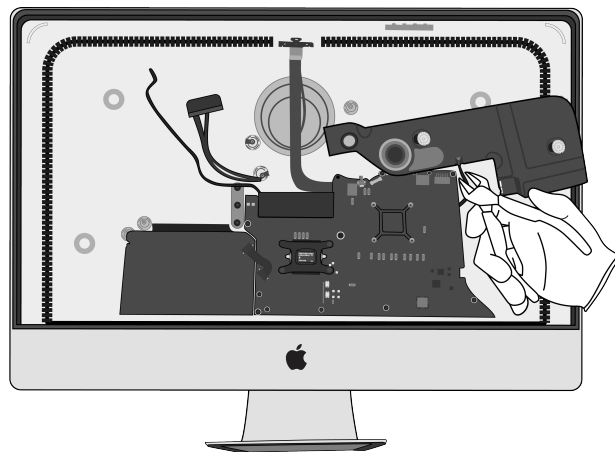

Fraction



Right speaker



16. Remove the main logic board.

- » *Pry the main logic board off the housing.*

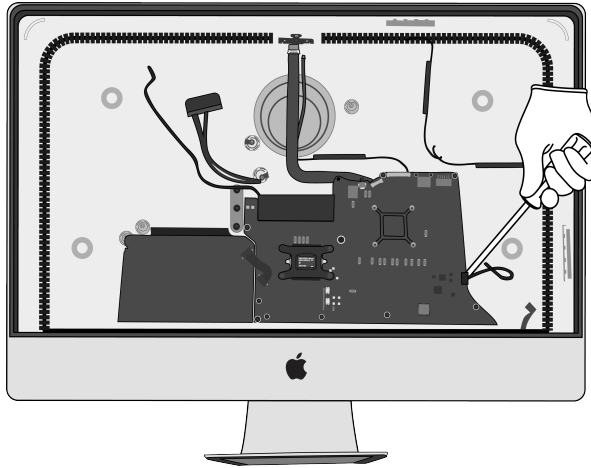

Tools Used



- » *Flip over the main logic board and pry it off the heat sink.*

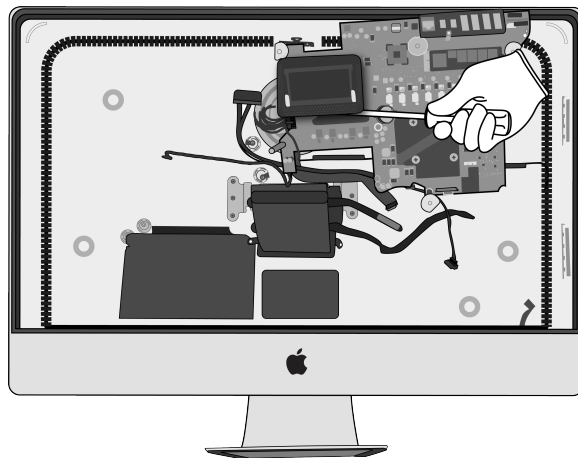

17. Remove the coin cell battery from the main logic board.

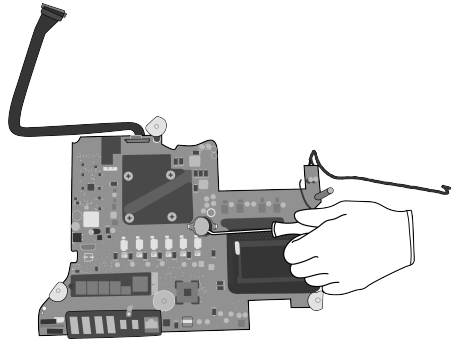

Tools Used



Fraction

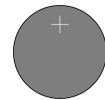

Coin cell battery

BT

Battery

18. Pull the four cables off the main logic board.

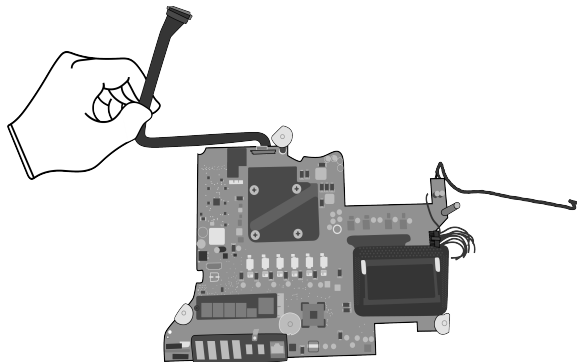

Fraction

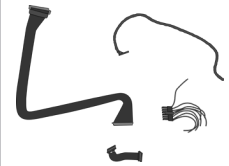

Cables

Cu

Copper

Fraction

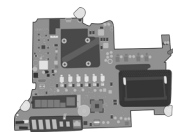

Main logic board

PMs

Precious Metals

- 19.** Pull the hard drive/main logic board connector off the housing.

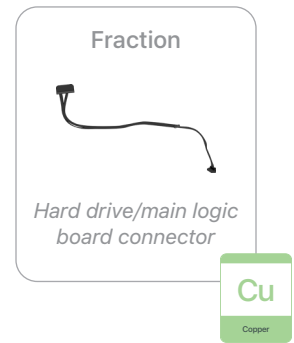
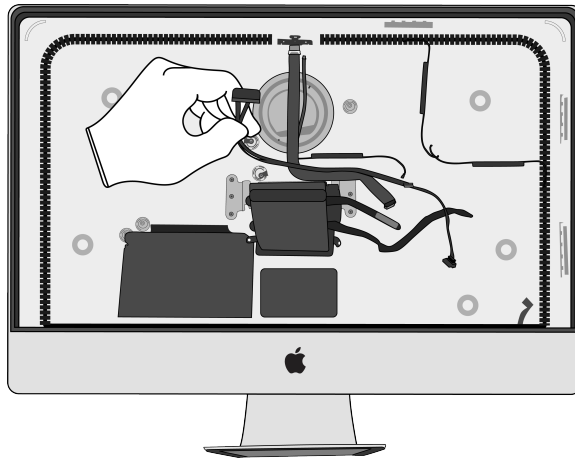

20. Remove the heat sink from the housing by unscrewing the three Torx T8 fasteners.

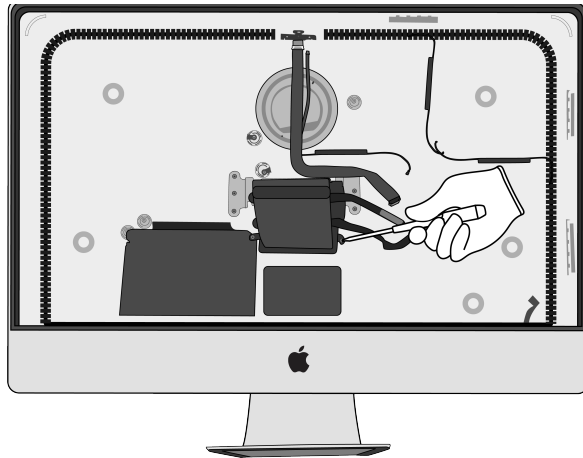

Tools Used

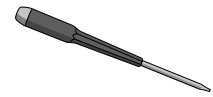

Fraction



Fasteners (x3)

Fe

Ferrous

Fraction

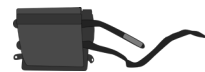

Heat sink

Cu

Copper

21. Pry off the three Wi-Fi antennas.

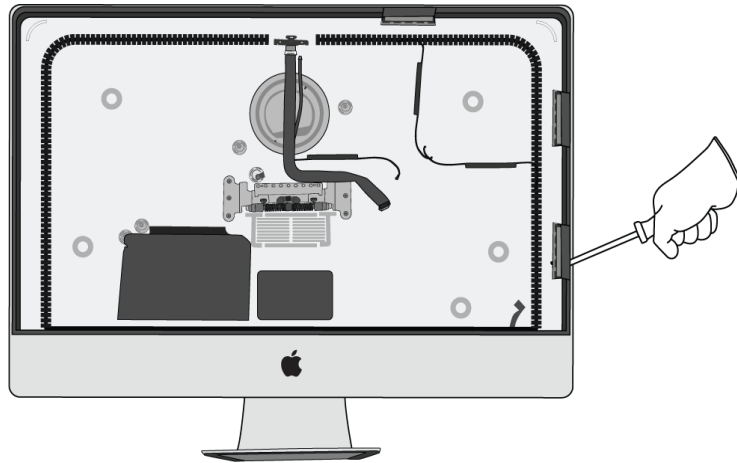

Tools Used

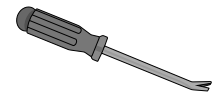

Fraction

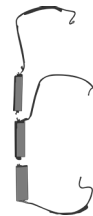

Wi-Fi antennas

Cu

Copper

22. Remove the camera with logic board.

» Pull off the ribbon cable by hand.

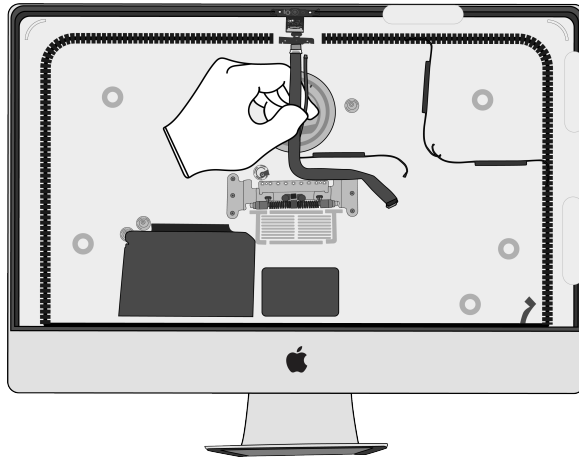

Tools Used

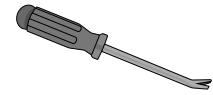

Fraction



Ribbon cable

Cu

Copper

» Pry off the camera with logic board.

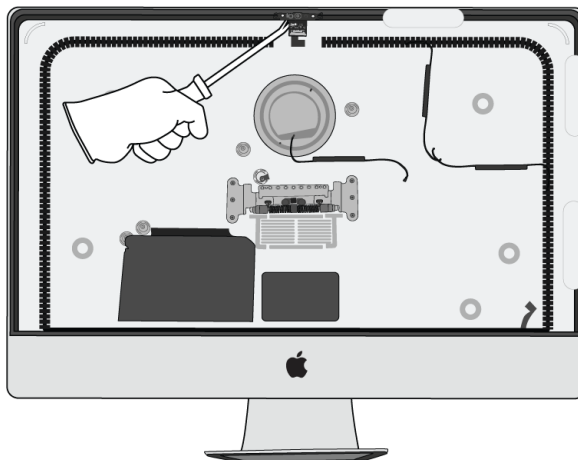

Fraction



Camera with logic board

PMs

Precious Metals

23. Pry off the microphone.

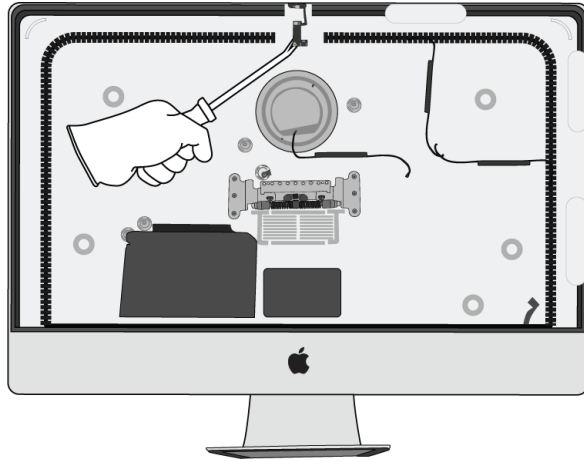

Tools Used

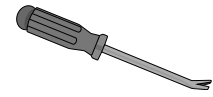

Fraction



Microphone

Cu
Copper

24. Pry off the Bluetooth antenna.

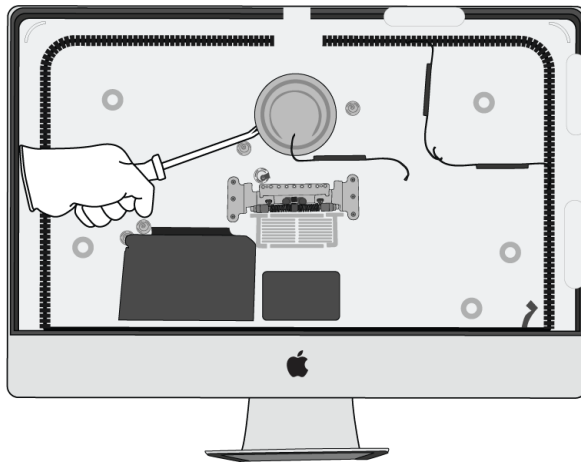

Tools Used

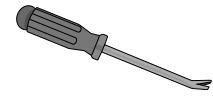

Fraction

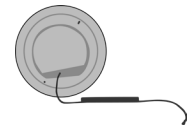

Bluetooth antenna

Cu
Copper

25. Remove the stand by unscrewing the nine Torx T8 fasteners.

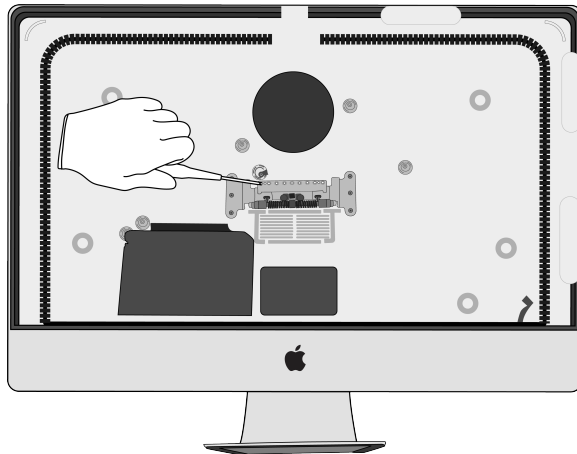

Tools Used

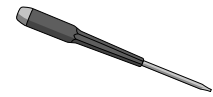

Fraction



Fasteners (x9)

Fe

Ferrous

Fraction



Stand

Al

Aluminum

- 26.** Remove the hinge from the housing by unscrewing the six Torx T8 fasteners.

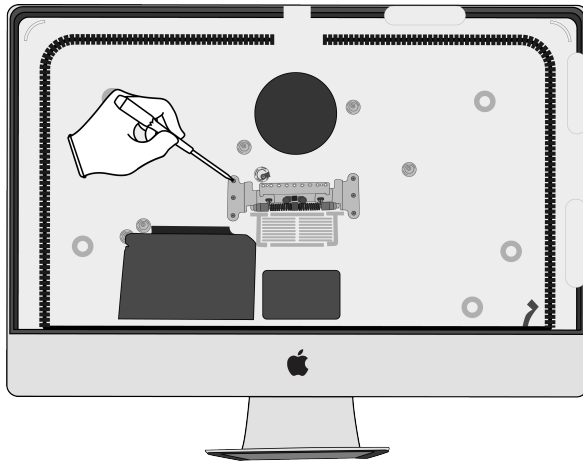

Tools Used

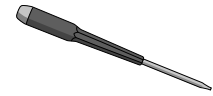

Fraction



Fasteners (x6)

Fe

Ferrous

Fraction

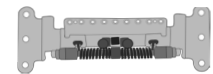

Hinge

Fe

Ferrous

27. Pry off the headphone jack.

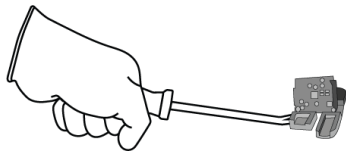
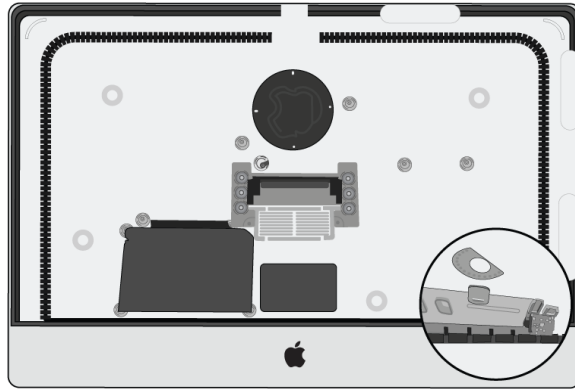

Tools Used

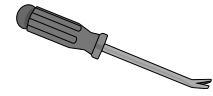

Fraction

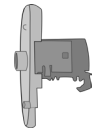

Headphone jack

Cu

Copper

28. Pry off the power connector.

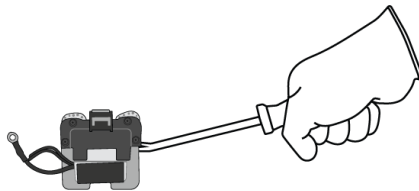
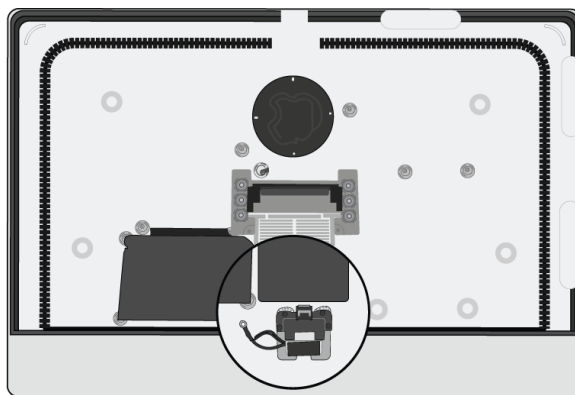

Tools Used

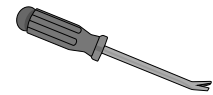

Fraction

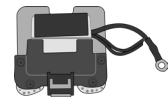

Power connector

Cu

Copper

29. Pry off the power button.

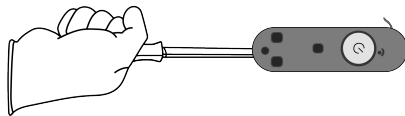
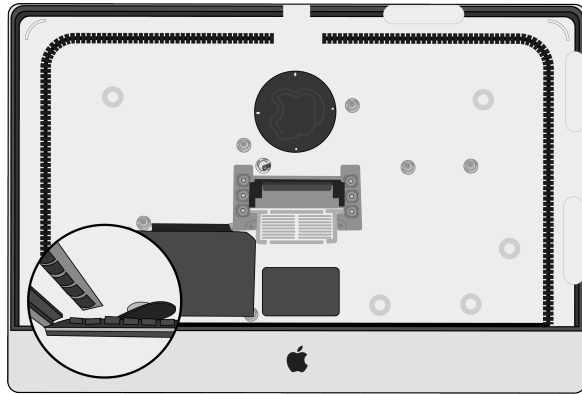

Tools Used



Fraction



Power button

Cu

Copper

Fraction

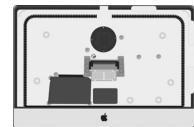







Housing

Al

Aluminum

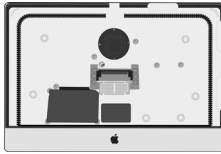
Material Categorization of Output Fractions

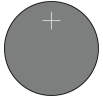
All outputs from this process must be managed, handled, and disposed of in accordance with applicable waste laws and regulations, including but not limited to the Waste Framework Directive and its national enactments in Europe.

Fraction	Downstream Processing
<p data-bbox="435 562 570 590">Aluminum</p>  <p data-bbox="456 793 548 821"><i>Mid plate</i></p>  <p data-bbox="472 1024 531 1052"><i>Stand</i></p>  <p data-bbox="459 1266 542 1293"><i>Housing</i></p>	<p data-bbox="964 562 1276 590">Primary Target Material</p>  <p data-bbox="924 814 1315 842">Potential Additional Materials</p> 
<p data-bbox="440 1398 565 1425">Batteries</p>  <p data-bbox="423 1581 581 1608"><i>Coin cell battery</i></p>	<p data-bbox="964 1398 1276 1425">Primary Target Material</p> 

Fraction

Downstream Processing

Ferrous

Primary Target Material



Display logic board cover



Hard drive brackets



Fasteners (x38)

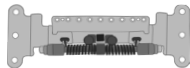

Hinge

Glass

Primary Target Material



LCD cell



Potential Additional Materials



Fraction

Downstream Processing

Hard Drives



Hard drive

Primary Target Material



Potential Additional Materials



Fraction

Downstream Processing

Logic Boards



Display logic board



LED logic board

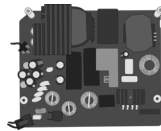

Power supply logic board

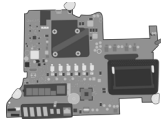

Main logic board



Camera with logic board

Primary Target Material



Potential Additional Materials



Fraction

Downstream Processing

Mixed Electronics



Fan



Power cord



Cables



Hard drive/main logic board connector



Heat sink



Ribbon cables

Primary Target Material



Potential Additional Materials



Mixed Electronics (cont.)



Microphone



Wi-Fi and Bluetooth antennas



Headphone jack

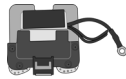

Power connector



Power button

Mixed Plastics

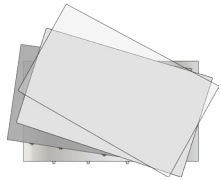

Display films

LED cover

Primary Target Material



Fraction

Downstream Processing

Rare Earth Magnets



Left speaker

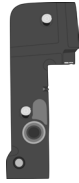

Right speaker

Primary Target Material



Potential Additional Materials

