



Pro Display XDR

Recycler Guide

March 2021

Contents

- 3 [About This Guide](#)
- 4 [Identification](#)
- 5 [Components Requiring Selective Treatment](#)
- 6 [Safety Considerations](#)
- 7 [Recommended Tools](#)
- 8 [Disassembly Instructions](#)
- 19 [Treatment of Output Fractions](#)

About This Guide

Apple Recycler Guides provide guidance for electronics recyclers on how to safely disassemble products to maximize recovery of resources. The guides provide step-by-step disassembly instructions and information on the material composition to help recyclers direct fractions to the appropriate material recycler.

To conserve important resources, we work to reduce the materials we use and aim to one day source only recycled or renewable materials in our products. A key path to reaching that goal is resource recovery from end-of-life electronics.

Disassembly procedures are intended to be performed only by trained electronics recycling professionals. The recycler is responsible for independently evaluating and ensuring compliance with all applicable environmental, health, and safety laws related to the work. These include but are not limited to laws relating to the management, handling, shipping, and disposal of the outputs of this work as waste and laws in place to ensure the health and safety of all employees who support this work.

For questions or feedback about this guide, email contactesci@apple.com.

Identification



Model number:
A1999

Components Requiring Selective Treatment

The following substances and components should be removed for selective treatment in accordance with Annex VII of Directive 2012/19/EU.

Substance/Component	Location	Removal Instructions
Printed circuit board if the surface is greater than 10 square centimeters	Main logic boards, display logic boards, LED array logic boards	Follow steps 1–7
Cover glass and LCD cell if the surface is greater than 100 square centimeters	Cover glass and LCD cell	Follow steps 1–3
External electric cables	Thunderbolt 3 Pro cable, AC power cord	Follow step 1
No further substances or components as listed in Annex VII		

Safety Considerations

The recycler is responsible for independently evaluating all activities undertaken by its employees to perform or support the work and ensuring compliance with all applicable health and safety laws related to the work. These include but are not limited to laws relating to the health and safety of all employees who perform or support this work. The recycler is also responsible for evaluating the workspace and ensuring that the area in which the work is to be undertaken is designed using ergonomic best practices and meets all ergonomic requirements to ensure the protection of its employees.

Hazard Warning



Broken glass hazard



Danger of harming your hands



Chemical inhalation hazard



Sharp element

Personal Protective Equipment

Personal protective equipment should be worn during the entire recycling process.



Wear hand protection



Wear a mask



Wear eye protection



Wear foot protection



Wear protective clothing

Recommended Tools

Flat-blade screwdriver

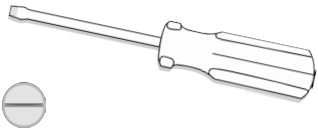

Flat surface scraper



Hammer

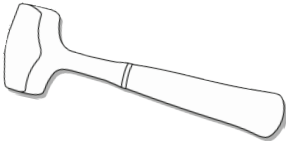

Heavy chisel



Nail-pulling screwdriver

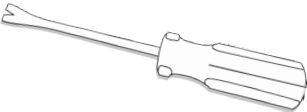

Disassembly Instructions

1. Remove the display power cable and the Thunderbolt 3 Pro cable from the device.

» Turn off the display.



» Unplug the cables.

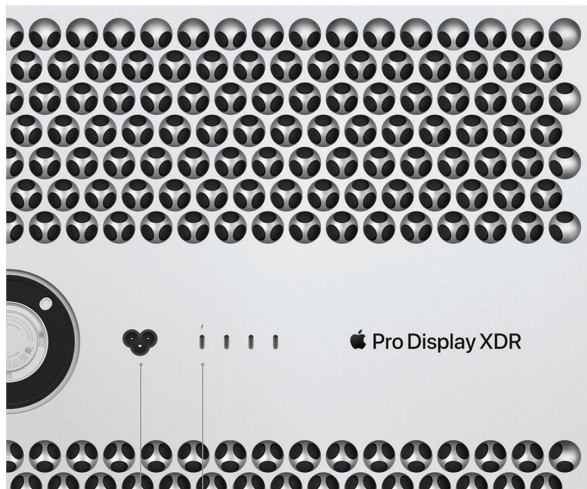
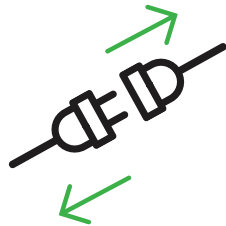

Power port

Thunderbolt 3 (USB-C) port

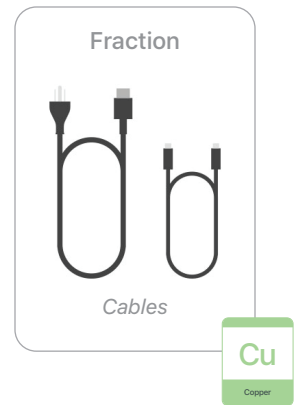

2. Remove the stand. If you have a Pro Stand, follow the first set of instructions. For a VESA mount adapter, follow the second set of instructions.

» Detach the Pro Display XDR from the Pro Stand.

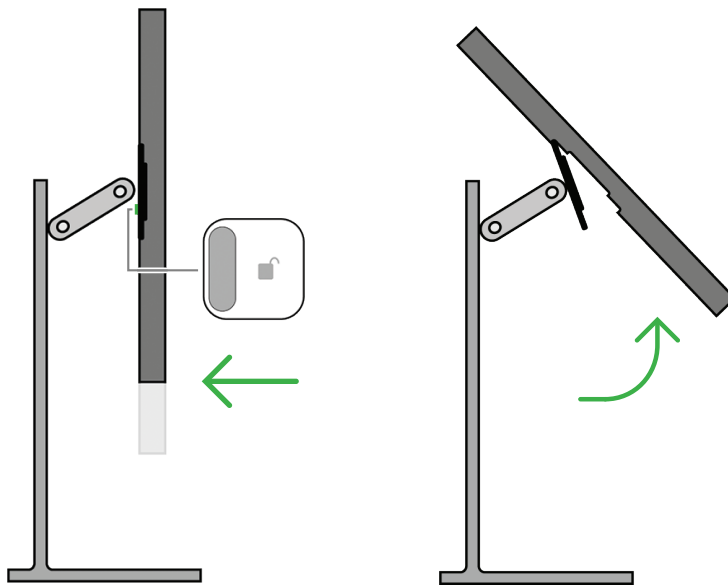
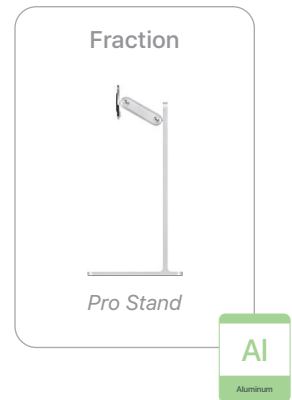
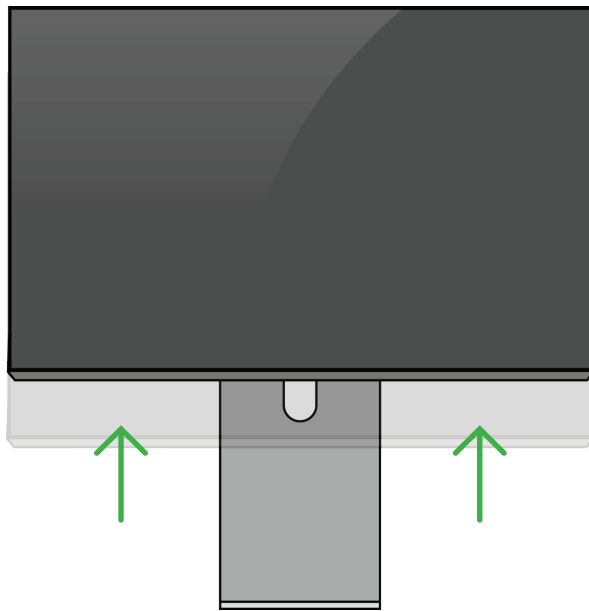

» Detach the Pro Display XDR from the VESA mount adapter.

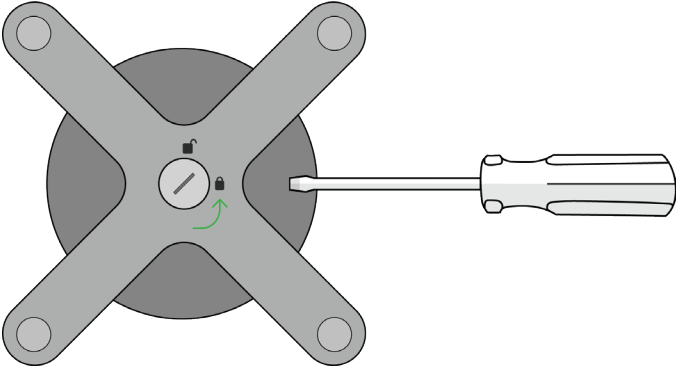

Tools Used



Fraction



VESA mount adapter

AI

Aluminum

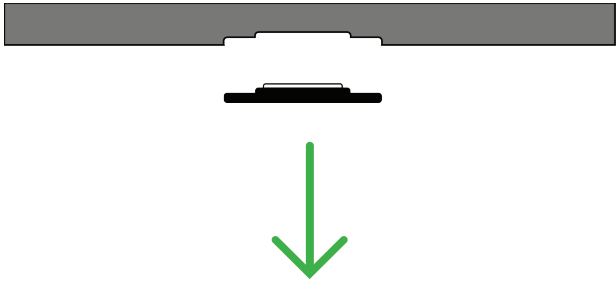

3. Remove the cover glass and LCD cell.

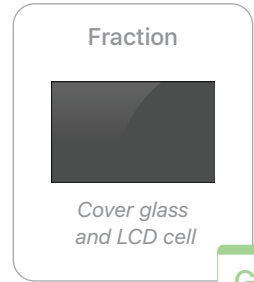
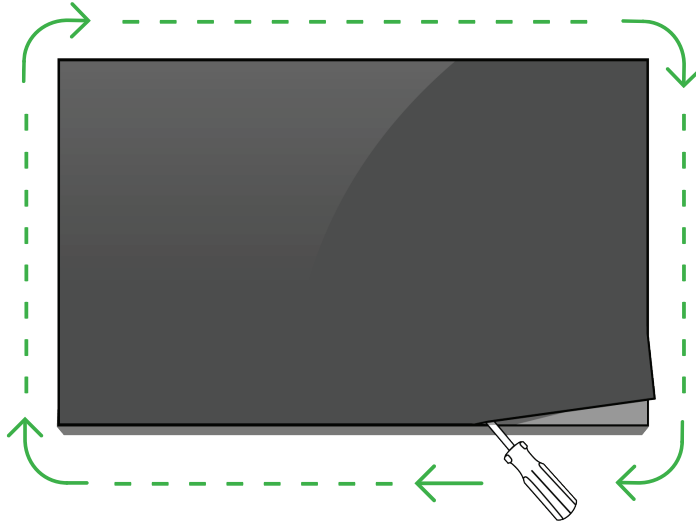
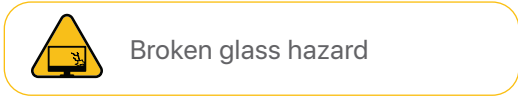

4. Remove the two logic boards attached to the display.



Sharp element



Fraction



Display logic board (x2)

PMs
Precious Metals

5. Remove the LED array.

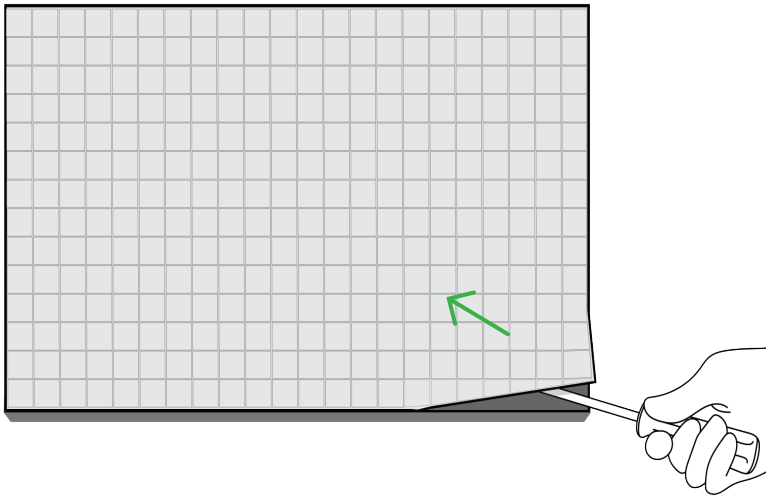

Tools Used



» Pull the LED array away from the base. Set the base aside for the next step.

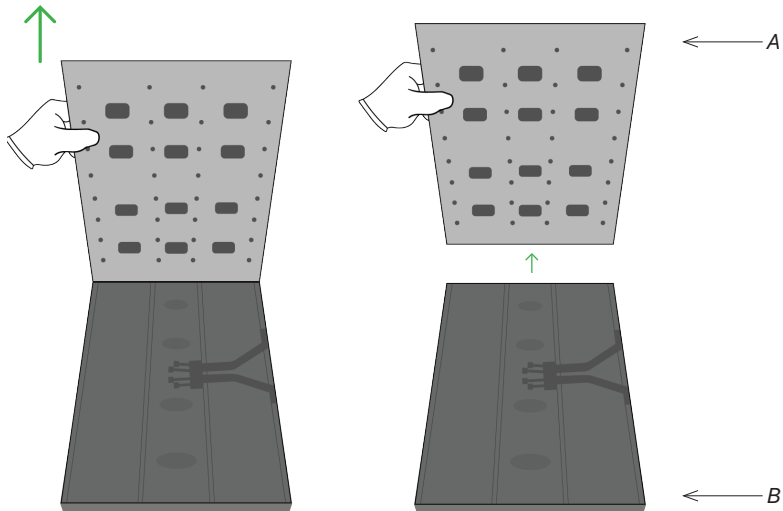

» Remove the reflector.

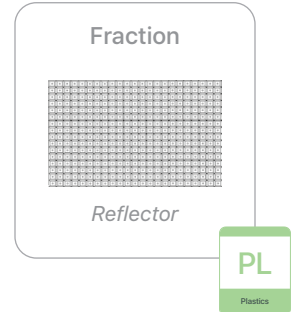
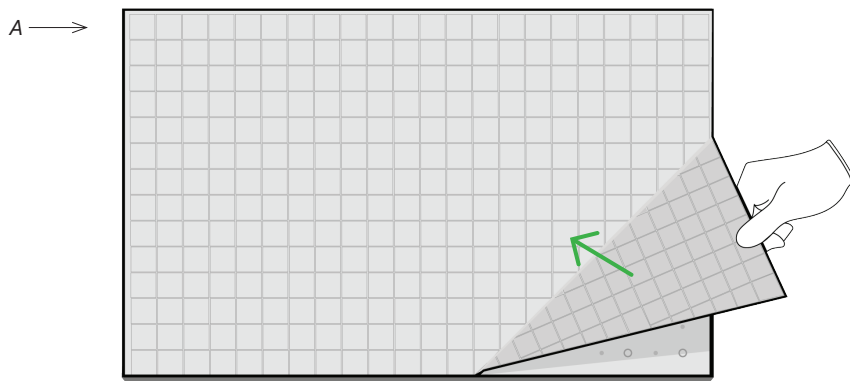

» Remove the two LED array logic boards.

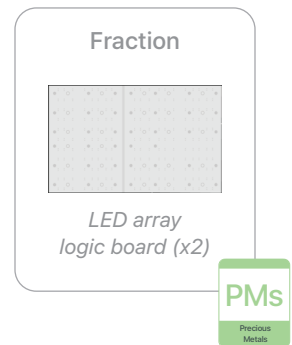
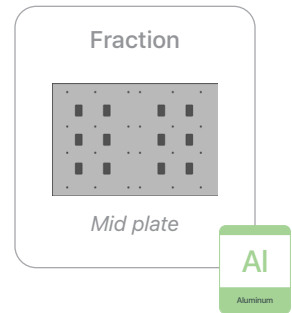
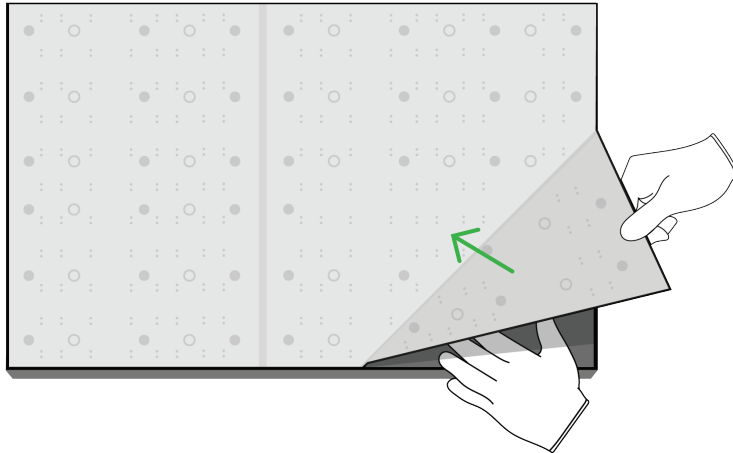
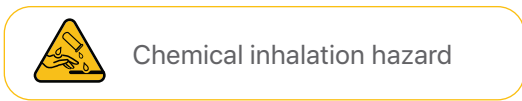

6. Remove the dust plates.

» Remove the ribbon wire.

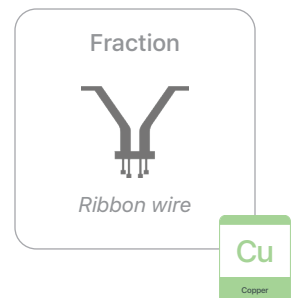
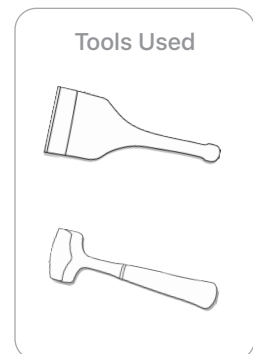
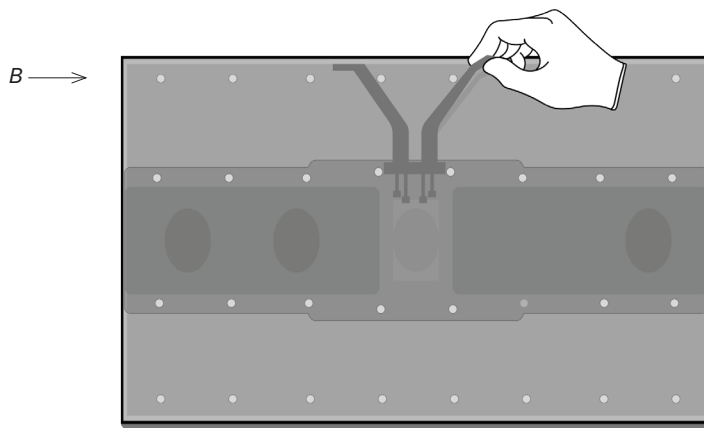

» Use the chisel to remove the fasteners.

 Danger of harming your hands

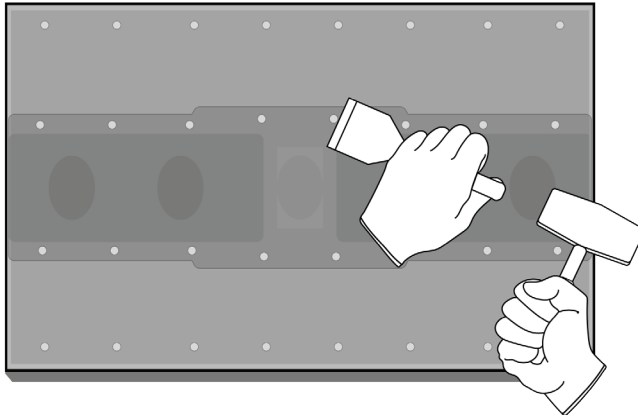

Fraction



Center dust plate

Al
Aluminum

Fraction

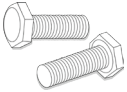

Fasteners (x35)

Fe
Ferrous

» Remove the side dust plates.

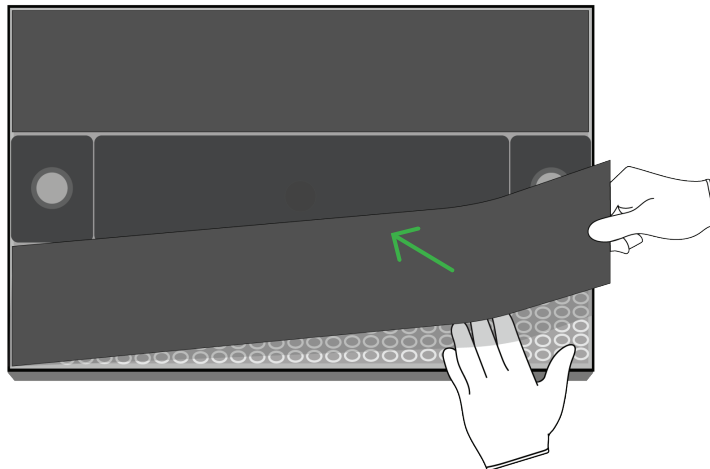

Fraction



Side dust plates

Fe
Ferrous

7. Remove the four main logic boards.

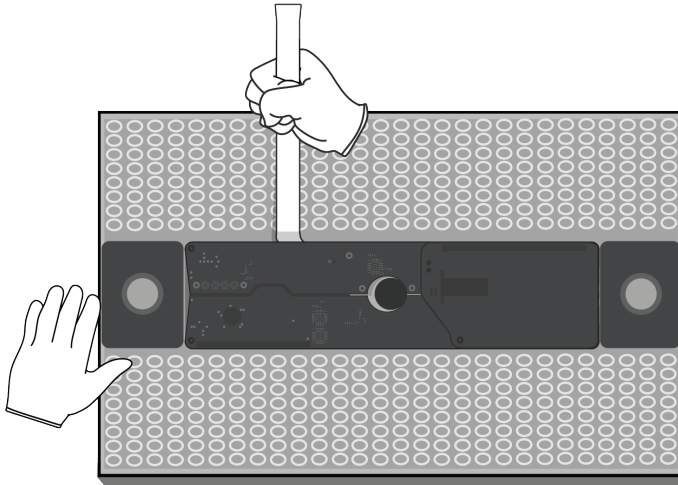

Tools Used



Fraction

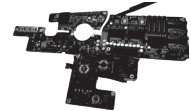

Main logic board (x4)

PMs
Precious Metals

8. Remove the magnets.

» Remove the center magnet.

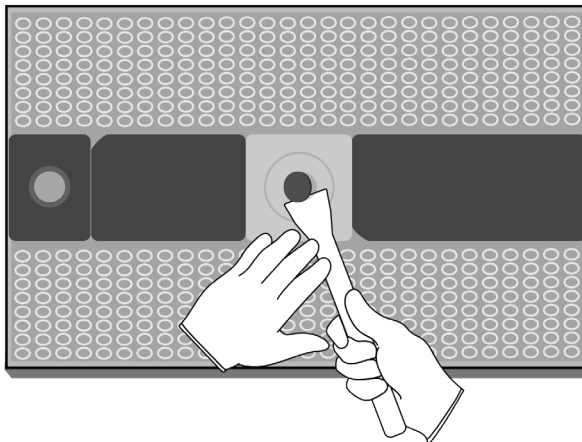

Tools Used

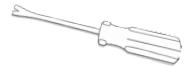

Fraction

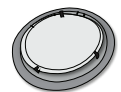

Magnet

REE
Rare Earth Elements

» Remove the side magnets.

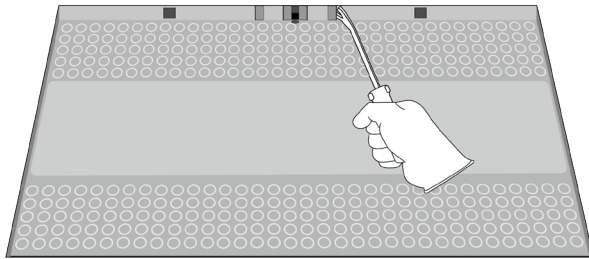

Fraction



Magnets

REE

Rare Earth
Elements

9. Remove the fans and AC power inlet.

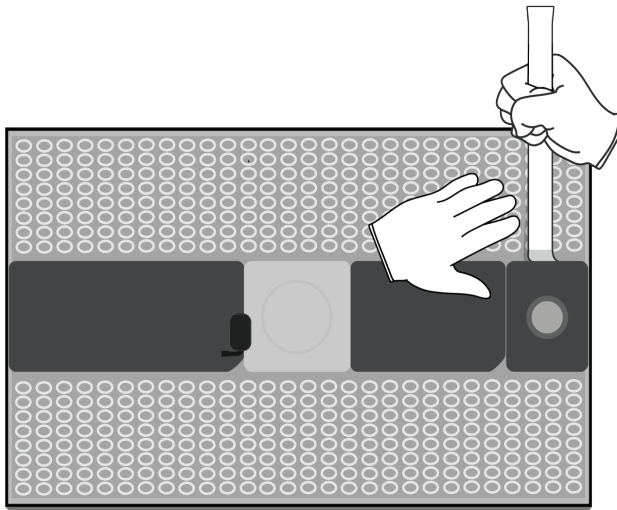

Tools Used



Fraction



Fans



AC power inlet

Cu

Copper

10. Remove the final ribbon wires and cables.

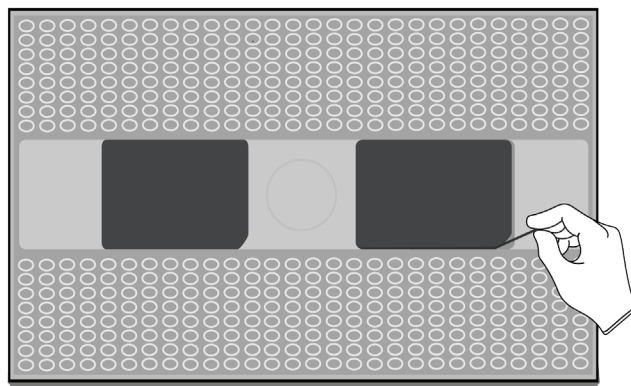
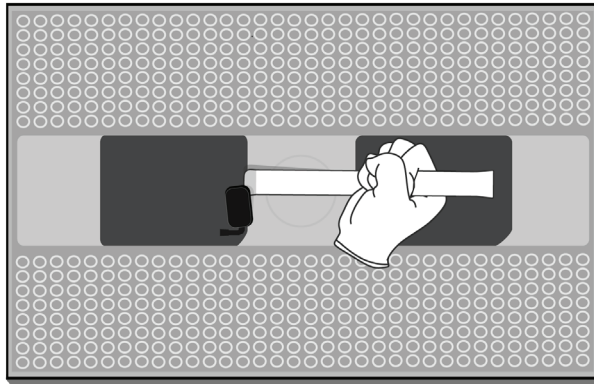

Tools Used



Fraction

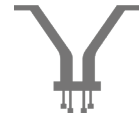

Ribbon wires
and cable

Cu

Copper

Fraction







Aluminum enclosure

Al

Aluminum

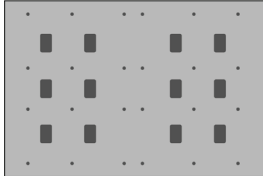
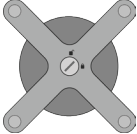
Treatment of Output Fractions

All outputs from this process must be managed, handled, and disposed of in accordance with applicable waste laws and regulations, including but not limited to the Waste Framework Directive and its national enactments in Europe.

Fraction	Downstream Processing
<p data-bbox="435 604 570 632">Aluminum</p>  <p data-bbox="418 779 581 800"><i>Center dust plate</i></p>  <p data-bbox="456 1041 545 1062"><i>Mid plate</i></p>  <p data-bbox="402 1262 602 1283"><i>VESA mount adapter</i></p>  <p data-bbox="451 1524 550 1545"><i>Pro Stand</i></p>  <p data-bbox="402 1753 599 1774"><i>Aluminum enclosure</i></p>	<p data-bbox="964 604 1276 632">Primary Target Material</p>  <p data-bbox="927 831 1312 858">Potential Additional Materials</p> 

Fraction

Downstream Processing

Logic Boards

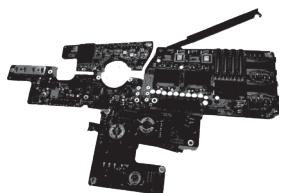

Main logic boards

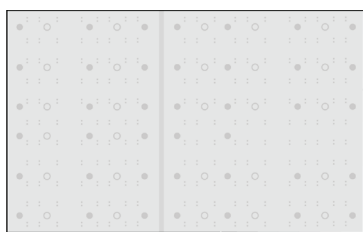

LED array logic boards



Display logic boards

Primary Target Material



Potential Additional Materials



Ferrous



Side dust plates

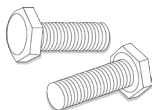

Fasteners

Primary Target Material



Fraction	Downstream Processing
----------	-----------------------

Cover Glass and LCD Cell



Cover glass and LCD cell

Primary Target Material



Potential Additional Materials



Mixed Electronics



Fans and AC power inlet

Primary Target Material



Potential Additional Materials

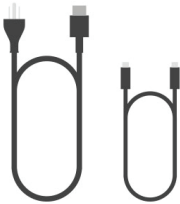

Cables

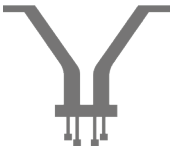

Ribbon wires

Fraction

Downstream Processing

Mixed Plastics

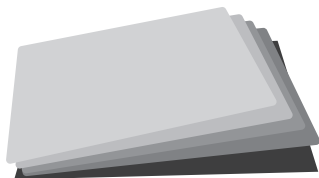

Films

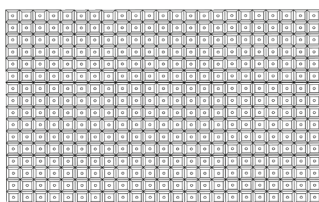

Reflector

Primary Target Material



Rare Earth Magnets

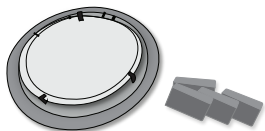

Magnets

Primary Target Material

