

11

SHAPES

The freedom to do anything to anything, any time, is what makes vector graphics so attractive. With a small vocabulary of generic object types and tools for manipulating them, you can render, or at least approximate, any kind of graphic imaginable.

Absolute freedom is not always a good thing, however. For example, a path (Chapter 12) can represent any possible two-dimensional shape. Yet often, what you need is not “any shape” but a simple, well-defined geometric entity, such as a rectangle. Of course, a four-node path will give you a perfect rectangle—but isn’t there a faster and more convenient way to create, specifically, rectangles?

Indeed, Inkscape has several object types for commonly used geometric shapes: rectangles, 3D boxes, ellipses, polygons, stars, and spirals. Each shape type has a corresponding creation tool, and Inkscape provides an array of numeric parameters, draggable handles, and shortcuts for manipulating those shapes. You cannot do *everything* to such a shape object, but what you *can* do to it makes perfect sense for its specific shape type.

INKSCAPE'S SHAPES VS. AI'S LIVE SHAPES

Shape tools in Inkscape are similar to the “live shapes” tools in the latest versions of Adobe Illustrator. It's interesting that AI didn't have this capability until 2015—a decade or more after Inkscape and most other vector editors had it!

You can always press Shift-Ctrl-C to convert a shape to a path (or, in the case of a 3D box, to a group). The reverse conversion, however, is not possible (at least not automatically). This means that a shape is a *higher level of abstraction* than a path: converting a shape to a path causes information loss and is therefore a one-way, destructive operation.

SHAPES IN SVG

SVG has its own shape elements for rectangles, ellipses, circles, and polygons. However, Inkscape's shapes are richer than what is defined in the SVG standard. As a result, Inkscape uses, as a fallback, the generic path element with some Inkscape-specific attributes whenever it cannot express the required shape using pure SVG. Details depend on the specific shape. Inkscape's rectangles are always represented by the `rect` SVG element; ellipses and circles start as `ellipse` and `circle` but are automatically switched to path when you turn them into arcs or segments (11.4.2); and stars, polygons, and spirals always use path.

11.1 Shape Tools

To create a new shape object, drag on the canvas with the corresponding tool—for example, dragging with the Rectangle tool creates a new rectangle. The newly created shape remains selected, and any selected shape displays its editing *handles* (similar in appearance to the gradient handles, 10.1). By dragging those handles, you can immediately edit what you have created.

Most handles work differently when you drag them with or without various keyboard modifiers (Ctrl, Shift, Alt). Hover your mouse over a handle to read a tip, in the status bar, on what this handle will do when dragged or clicked with different modifiers.

Like most tools, shape tools have certain object selection capabilities. In any shape tool, you can select an object (not necessarily a shape) by clicking—which works like Ctrl-clicking in the Selector tool (that is, ignores any grouping, 5.10). Alt-click (select under, 5.9) works but Alt-wheel does not; Shift-click (add to selection or remove from selection) works, but the rubberband does not (because dragging creates a new shape). Escape deselects.

To *create* a rectangle, you need to use the Rectangle tool—but *editing* a shape is another matter. *Any* shape object, when selected, lets you drag its shape-specific handles in *any* shape tool, as well as in the Node tool (F2). When you have *multiple* shapes selected, however, only the Node tool lets you edit any of their handles.

11.1.1 Shape Parameters

Each shape tool has its own controls bar (2.3) where you can view and edit parameters. Usually, there are a few numeric entry fields and toggle buttons, as well as a button to reset the values to the defaults (located to the right of all the other controls).

The leftmost label on the controls bar says either **New:** or **Change:** before all other controls. “New” means that no shape of the corresponding type is selected, so the parameters you’re editing will be used for a new shape when you create it. “Change” indicates that the selection contains shapes of the current tool’s type—to which your parameter change will therefore apply.

Any changes made to these controls are remembered and used for the next object you draw with that tool—just as the style properties you assign to an object are typically used for the next created object (11.1.2). For example, after you change the number of corners of a star, any new stars you draw will have the same number of corners.

Moreover, even simply selecting a shape sends its parameters to the controls bar, where those parameters are remembered and later used for newly created shapes of that type. This makes it easy to reuse shape parameters—similar to pasting a style from object to object (8.1) but without using copy and paste. For example, if you have a slightly rounded star with nine corners and no randomization somewhere in your drawing, simply select that star in the Star tool and subsequent stars will be created with exactly the same parameters.

11.1.2 The Style of New Shapes

What style is going to be used for the next shape you create? You can find the answer to this question by looking at the far right end of the controls bar. All shape tools—in fact, all object-creating tools—have a style swatch there displaying the fill, stroke, and opacity that will be used for the newly created objects (Figure 11-1).

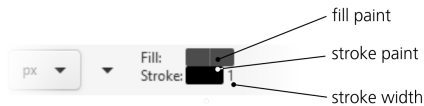

Figure 11-1: This style will be used for newly created shapes.

By default, all shape tools except Spiral use the *last set style* as the style of new objects they create. This means that every time you change some style property in an object, Inkscape remembers that property and will use it for new shapes. For example, after you paint something green, all new rectangles, ellipses, stars, and so on will have the same shade of green. Or if you assign a 3 px stroke width with a 1:1 dash pattern to some path or shape, new shapes will also have that stroke style. (This behavior becomes more complex for 3D boxes, which use not one but six different styles for the six sides of a box; see 11.3.5 for details.)

If you don’t want the most recently set style to be used for new objects, you can change that. Double-click a shape tool’s button in the toolbox on the left

to open that tool's page in the Preferences dialog (3.1.1), as shown in Figure 11-2. There, use the two-way switch to set the style of new objects either to the *last used style* or a fixed *tool style* specific to this tool. To change the tool style, click the **Take from selection** button to remember the style of the current selection as the tool style.

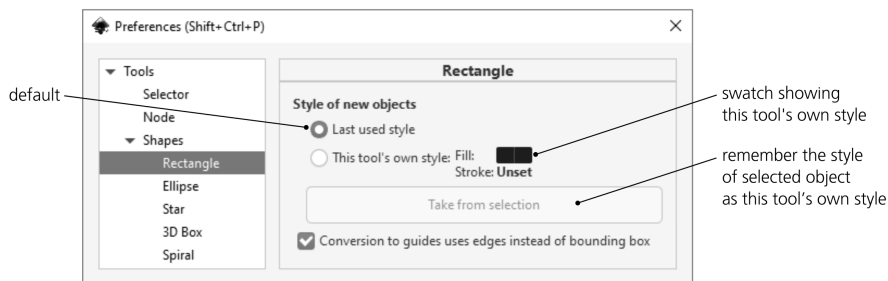

Figure 11-2: A shape tool's preferences page

For example, if you want all new rectangles to be black without stroke, select some black strokeless object, go to **Preferences** ▶ **Tools** ▶ **Shapes** ▶ **Rectangle**, switch to **This tool's own style**, and click **Take from selection**.

11.2 Rectangles

Rectangles, boring as they may sound, are the most commonly used type of shape. You'll be hard-pressed to find a design not dominated by rectangles. Inkscape makes creating and editing rectangles as easy and versatile as possible.

Switch to the Rectangle tool (by clicking the toolbar button on the left or by pressing R or F4) and drag anywhere on the canvas, as shown in Figure 11-3. Drag with Ctrl to get a square or an integer-ratio (2:1, 3:1, and so on) rectangle; drag with Shift to make the starting point the rectangle's center instead of one of the corners. You can combine Ctrl and Shift.

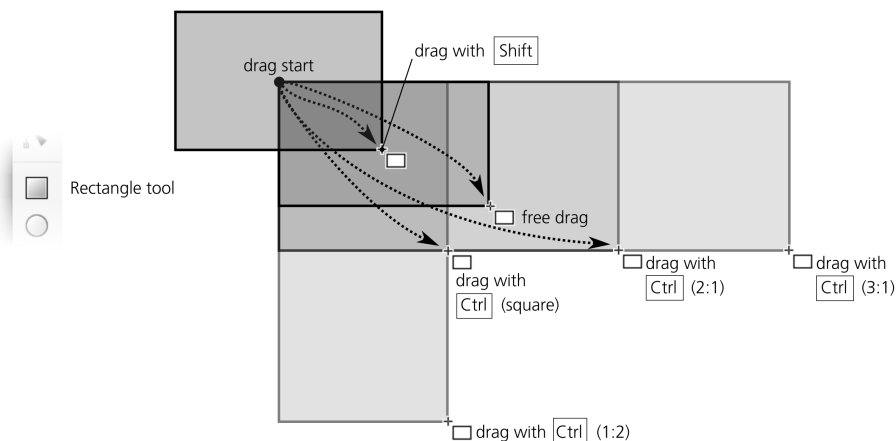

Figure 11-3: Drawing rectangles

The new rectangle displays four handles, as shown in Figure 11-4. Two are little squares in the top-left and bottom-right corners; these are the *sizing handles*. The two others, which appear as little circles, are *rounding handles*; they are both in the top-right corner and look like one handle until you drag one of them away.

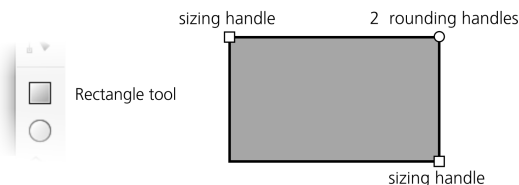

Figure 11-4: Rectangle handles

11.2.1 Sizing

Using the sizing handles, you can resize the rectangle simply by *dragging* any of the sides in any direction. Dragging with Ctrl locks the width, height, or width/height ratio by snapping the handle to the rectangle’s sides or to the diagonal.

NOTE

Unlike the Selector tool, you cannot move, for example, the bottom-right sizing handle further up or further to the left than the top-left handle. The most you can do is make the rectangle invisible by reducing its width, its height, or both to zero.

In the controls bar, two numeric controls labeled W and H also control the width and height of the selected rectangle. They use the measurement unit chosen in the unit selector on the right.

Why use the sizing handles when you can just as easily resize the rectangle with the Selector tool? The Selector tool always scales things horizontally or vertically in the document coordinate system—that is, along the edges of the page. In contrast, a rectangle’s sizing handles scale it *along the sides* of that rectangle, even if the rectangle was rotated or skewed. The W and H values also always reflect a rectangle’s intrinsic width and height, not necessarily the dimensions of its bounding box, which may be quite different if the rectangle was rotated or skewed (Figure 11-5).

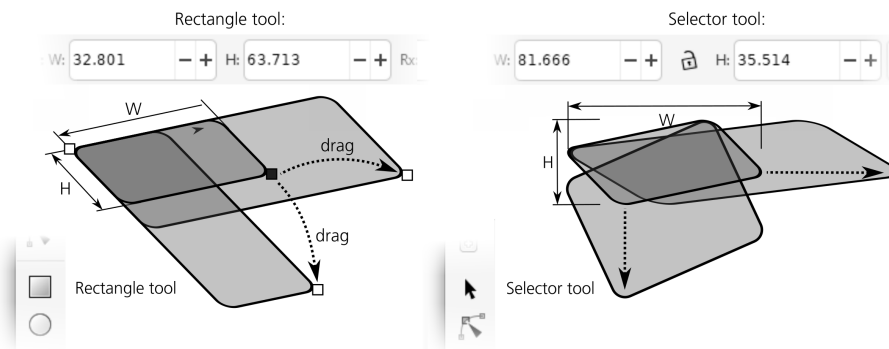

Figure 11-5: Rectangle sizing handles vs. scaling with the Selector tool

Another advantage of the sizing handles is that they always preserve the radii of the rectangle's rounded corners (although, as you'll see shortly, this is possible with the Selector as well).

As with any other shape type, you can make handles of rectangles snap (7.3) to grids, guides, and other objects. If you start from a particularly rotated and/or skewed rectangle and enable snapping of nodes to paths, nodes, and intersections, it's easy to use duplication (Ctrl-D) and sizing handles to create snugly fitting, gapless compositions of axonometric rectangles, as shown in Figure 11-6.

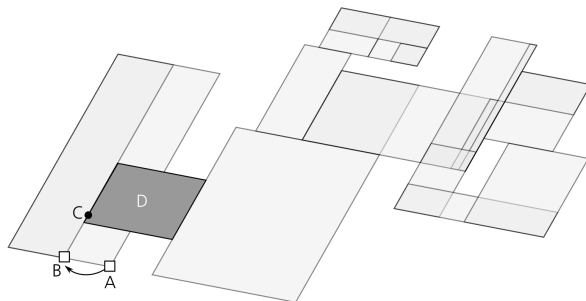

Figure 11-6: Snapping slanted rectangles to each other

What snaps is the *mouse point*, not necessarily the handle itself. These two may diverge quite far if, for example, you are resizing a rectangle with Ctrl to lock its width or height. In Figure 11-6, I wanted to make the leftmost rectangle narrower but keep its height, so I moved the handle with Ctrl from A to B. However, I also wanted this rectangle to abut the left edge (marked by a bold line) of rectangle D. So, while dragging and without letting go of Ctrl, I moved the mouse cursor to point C so it snapped to the edge I needed (the actual handle was then at B), and there I released the mouse. To make this possible, I enabled nodes and handles as snappable and paths as snap targets (7.3).

11.2.2 Rounding

To round corners of a rectangle, grab one of the circular rounding handles and drag it along the side of the rectangle. All four corners of the rectangle become rounded by circular arcs. Also, now you can see the second rounding handle—it remains in its original position in the corner (Figure 11-7). If *circular* rounded corners are what you need, you can leave it at that. If you want *elliptical* corners instead, move that other handle away from the corner along the other side of the rectangle.

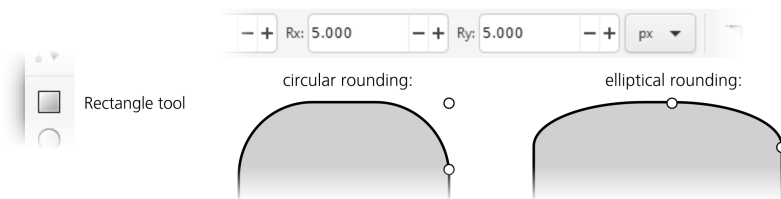

Figure 11-7: Rectangle rounding handles

NOTE

Even circular rounding can look elliptic if the rectangle is skewed (compare 24.3).

Using the Rx and Ry numeric fields in the controls bar, you can explicitly set both rounding radii in absolute units (chosen with the unit selector to the right). If multiple rectangles are selected, the value you type will apply to all of them (if any non-rectangles are selected, they will be ignored). The button with a corner icon on the right removes any rounding from the selected rectangles.

The maximum distance you can move the rounding handles is half the length of the corresponding rectangle size. Reaching this maximum with both rounding handles effectively turns a square into a circle and a non-square into an ellipse.

In technical drawings such as schemes and diagrams, the size and shape of rounded corners often needs to be the same in the entire composition, even if the sizes of the rectangles are different. Inkscape makes this easy. The second of the four **Affect** buttons on the Selector toolbar (6.11), the one with two concentric rounded corners, controls whether the rounded corners are scaled when a rectangle is scaled. Figure 11-8 shows a bunch of rounded rectangles scaled with this button on and off.

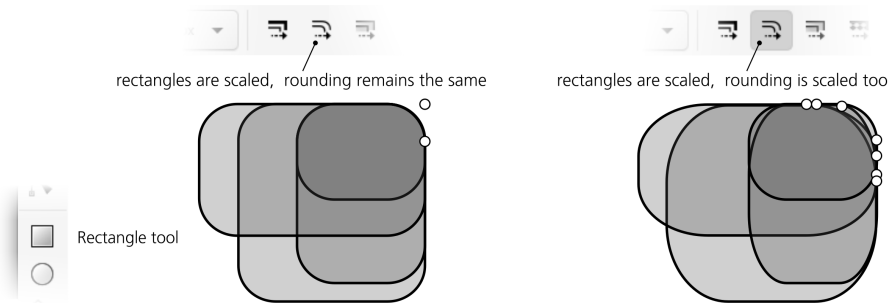

Figure 11-8: Scaling a rectangle may or may not affect its rounding radii.

Here are the shortcuts for the rounding handles of a rectangle:

- Drag with Ctrl to make the rounding circular (that is, make the other radius the same).
- Ctrl-click a handle to make the rounding circular without dragging.
- Shift-click a handle to remove rounding.

11.3 3D Boxes

A *3D box* is an object representing a projection of a three-dimensional box (rectangular prism) onto the plane of the drawing. It therefore consists of six *sides*, and from a pure SVG viewpoint, it is simply a group of six paths, each with four nodes and four linear segments. Inkscape, however, treats these objects in a special way—so you can, for example, resize and move them in their own 3D space or reposition the vanishing points of multiple boxes at once.

Apart from the 3D Box tool, most other tools and commands treat a 3D box as a group. In particular, in the Selector tool, you can Ctrl-click, Ctrl-Alt-click, or Alt-drag to select any side within the box (most often for changing its style), just as you would select objects inside a group. Selecting sides inside a box does not destroy the box; however, you can easily “unbox” it with the Path ▶ Object to Path (Shift-Ctrl-C) command—this removes any 3D-specific capabilities and leaves you with a regular group with paths inside. You can also simply Ungroup (Ctrl-U) a 3D box.

11.3.1 Why Use 3D Boxes?

What makes such a specialized construct as a 3D box useful?

Inkscape is not going to replace a full-featured 3D application—it does not model a “true” three-dimensional space in which you could place your 3D objects. Inkscape is and always will be a two-dimensional drawing tool. However, it is often used to draw three-dimensional objects. To assist in this, Inkscape implements a simple, 2D-oriented system of *perspective drawing*—whose principles have remained unchanged since being perfected by the Renaissance artists six centuries ago.

In Inkscape, you don’t “build a 3D world”; you just create a flat drawing that represents a three-dimensional scene in a certain perspective. Inkscape’s 3D Box tool is mostly a helper that makes creating such perspective drawings easier. In perspective drawing, a box is almost as important as a rectangle is for two-dimensional drawing and layout; drawing anything in correct perspective usually starts with drawing its enclosing box. So Inkscape’s 3D boxes are often used not for their own sake but as quick and 3D-accurate guides for your perspective drawing—something to align your objects against and to inscribe them into (see Chapter 22 for an example).

On the other hand, the ease of creating and reshaping 3D boxes in Inkscape is an inspiration in itself. The About screen (Help ▶ About) of Inkscape 0.46 (in which this tool made its debut) is an example of a piece of art dominated by 3D boxes shown in Figure 11-9.

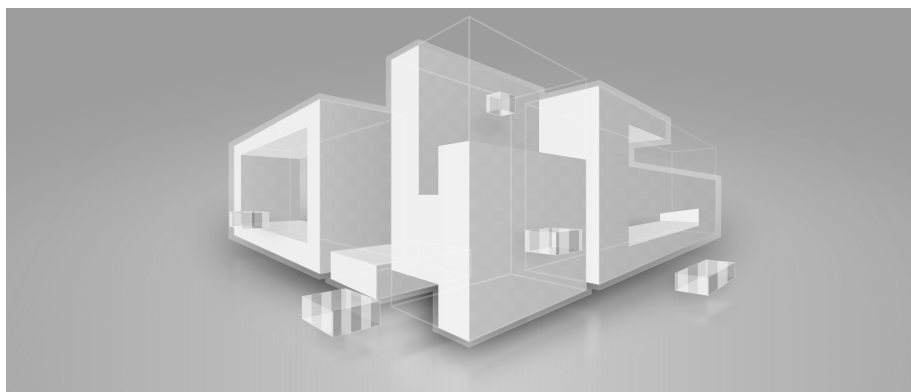

Figure 11-9: A composition of 3D boxes

11.3.2 Drawing

To draw a 3D box, switch to the 3D Box tool (the X key or Shift-F4) and drag somewhere within the page frame (because the default vanishing points are on the left and right edges of the page). This creates the front side of the box in the X/Y plane; the depth of the box along the Z axis remains fixed. To switch to the Z axis, drag with Shift; this freezes the X/Y side but lets you adjust the depth, as shown in Figure 11-10.

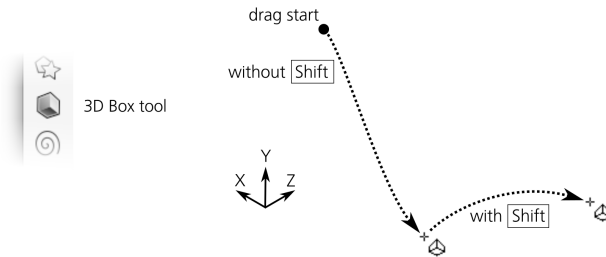

Figure 11-10: Drawing a 3D box

Once a box is created, it displays a diamond-shaped handle in each of the eight corners as well as an X-shaped handle in the center. Also, colored lines go from the edges of the box to the vanishing points. Let's look at these controls in detail.

11.3.3 Perspective and Vanishing Points

Each 3D box exists in a certain *perspective*, which is defined by three *vanishing points*, corresponding to the three spatial dimensions: X (red guides), Y (blue guides), and Z (yellow guides). Each vanishing point may be either *finite* (it is an actual handle that you can drag around) or *infinite* (it is just a direction toward a point at infinity; you can change the angle of this direction).

By default, the X and Z vanishing points are finite, located in the middle of the left and right edges of your document's page. The Y vanishing point is infinite, its direction being vertical, as shown in Figure 11-11.

You can toggle the finite/infinite status of each dimension's vanishing point using the three buttons in the tool's control bar. The finite vanishing points can be dragged freely on the canvas. The angles of the infinite ones can be adjusted numerically in the controls bar or by the shortcuts:

- [and] rotate X vanishing point directions.
- (and) rotate Y vanishing point directions.
- { and } rotate Z vanishing point directions.

Without modifiers, these keys rotate by the angle step (the default is 15 degrees, 6.3). With Alt, they rotate so that the perspective lines are moved by (at most) 1 screen pixel at the current zoom.

Shift-X, Shift-Y, and Shift-Z toggle the corresponding vanishing points from finite to infinite and back.

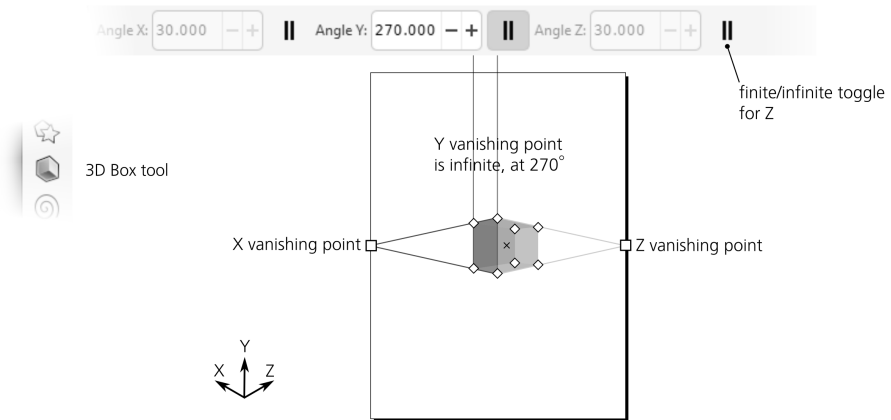

Figure 11-11: The default perspective

For example, you can make all three vanishing points infinite and rotate them to the angles of 150 (X), 90 (Y), and 30 (Z) degrees for drawing isometric boxes without any perspective foreshortening. Also, while boxes look most natural when they are located somewhere in between the three vanishing points, they are not obliged to be there; moving a box away from the sweet spot of a “natural” perspective makes it look curiously distorted—which, sometimes, may be exactly what you want.

11.3.3.1 Merging and Unmerging Perspectives

For a newly created 3D box, Inkscape reuses the perspective of the *last selected* 3D box. As a result, boxes in your drawing will normally *share* the same perspective. When you change a perspective, *all* boxes using this perspective—whether selected or not—respond to the change, as shown in Figure 11-12.

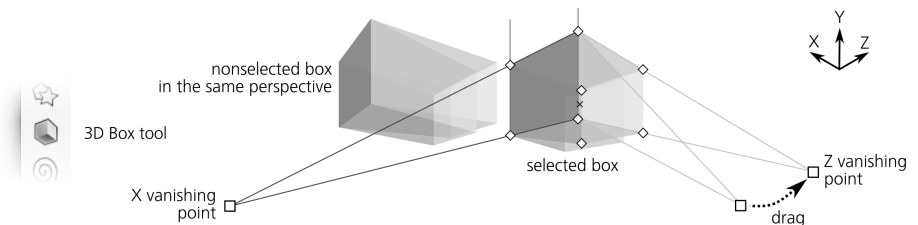

Figure 11-12: Changing a perspective by dragging a vanishing point affects all the boxes in this perspective.

If several boxes share a perspective, you can *unmerge* any one of them by dragging its finite vanishing point (with only that box selected) with Shift. Unlike dragging without Shift, this change affects only the selected box. Once unmerged, any change of the box’s perspective (by dragging with or without Shift or via the controls bar) will affect only that box.

Also, when you move a 3D box object in the Selector tool, its own set of vanishing points moves along with the box, effectively unmerging its perspective if it was shared. This means you should avoid manipulating 3D boxes in the Selector tool if you want your 3D scene to keep a consistent perspective.

It is just as easy to *merge* two different perspectives together so they become one. To do this, select two boxes with different perspectives and move a finite vanishing point of one perspective to the same-dimension (same-color) point of the other—they will snap and join (similar to how the gradient handles join when dragged close enough, 10.4.3), as shown in Figure 11-13. The boxes will now have the same perspective. (If the perspectives had any infinite vanishing points, their direction angles must be the same for perspective merging to work.)

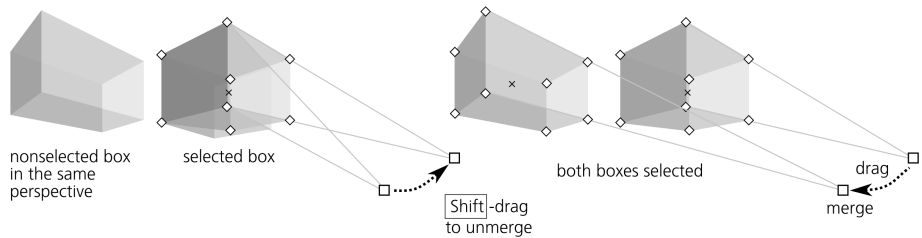

Figure 11-13: Merging and unmerging vanishing points

11.3.4 Handles

Each 3D box, when selected in any of the shape tools or the Node tool, displays eight diamond-shaped *corner handles* and an X-shaped *center handle*. Without modifiers, the four handles on the front X/Y side reshape that side, while the four others change the Z depth of the box. With Shift, however, their roles are reversed, as shown in Figure 11-14.

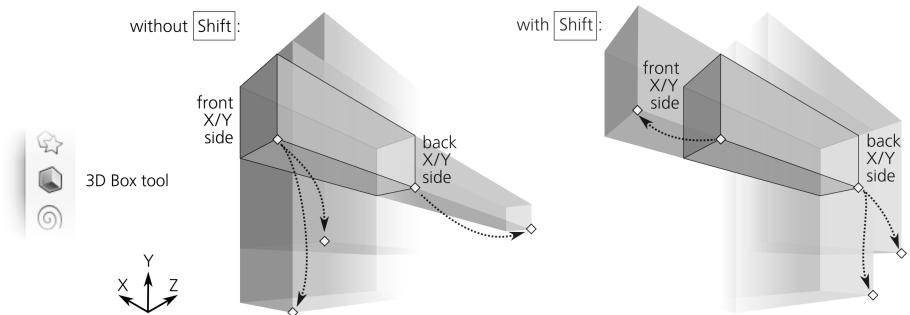

Figure 11-14: Dragging a box's corner handles with and without Shift

With Ctrl, the side-resizing handles snap to the continuations of that side's edges and its diagonal. For depth-changing handles, Ctrl has no effect (Figure 11-15).

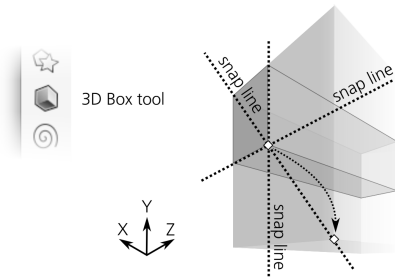

Figure 11-15: Dragging a box's corner handles with Ctrl

You can make any of the dimensions of the box negative by dragging a handle up to and beyond the other handle on the corresponding axis. This inverts the order of the sides (that is, the far side on that axis becomes the near side and vice versa). This is not recommended, though, because such an inside-out box does not always render its sides in the correct z-order.

Dragging the central handle without modifiers moves the box in the X/Y plane; with Ctrl, it snaps it to the directions of its X and Y vanishing points as well as the bisector between them. With Shift (with or without Ctrl), the central handle moves the box toward its Z vanishing point, as shown in Figure 11-16.

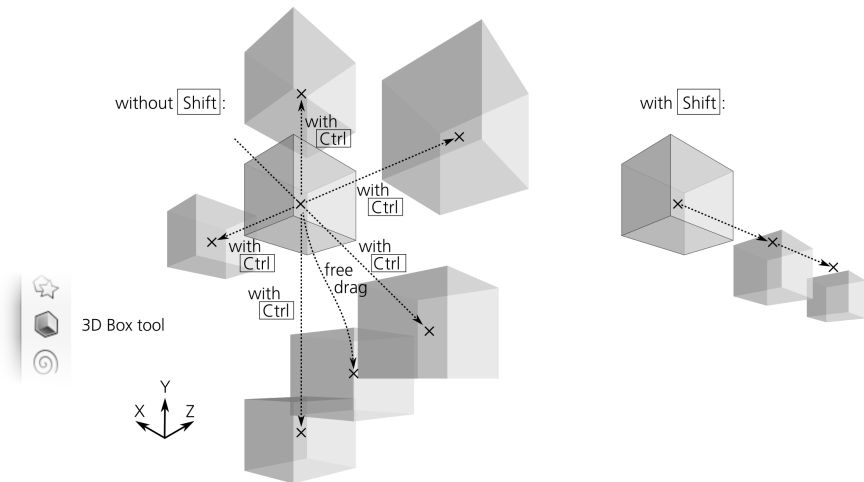

Figure 11-16: Dragging a box's center handle with and without Shift

As with rectangles, if you enable snapping of nodes to paths, nodes, and intersections (7.3.1.2), your 3D scene will feel very snappy—everything you draw or resize will be eager to join and line up, making it a pleasure to build solid gapless constructions out of boxes. As a simple example, to build a multi-story building, draw a single-story box, then duplicate it by Ctrl-D and Ctrl-drag the central handle of the copy upward to raise it to the next level until it snaps into place, as Figure 11-17 demonstrates.

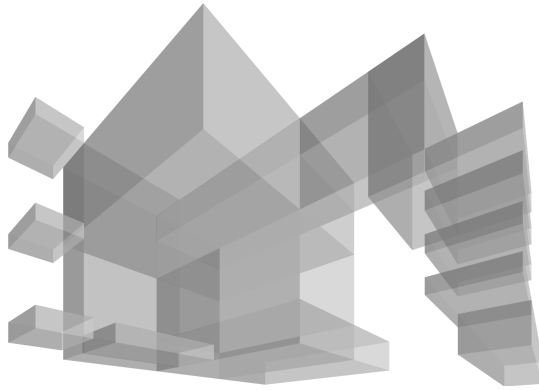

Figure 11-17: Using Ctrl and snapping handles to paths makes building complex scenes easy.

11.3.5 Styling

From the viewpoint of styling, a 3D box is no different from a group of paths. By default, all six sides of a new box have different shades of blue; you can paint the entire box with some color (removing any difference between the sides), or you can Ctrl-click and Ctrl-Alt-click to select any single side to paint it separately.

You can even *enter* the box just as you would enter a group (5.10) by selecting it and pressing Ctrl-Enter. After that, you can select single sides by simple clicking or using Tab and Shift-Tab. No matter how you style its sides, the box remains a box, so its styling is preserved in any 3D transformations. To remove the 3D box functionality, you need to ungroup it (Ctrl-U) or convert it to paths (Shift-Ctrl-C, which actually converts it to a *group* of paths).

Apart from changing fill or stroke paint, you can apply blur (17.1), clips, and masks (18.3) to an entire box or to any of its sides individually. If you lower the opacity of a 3D box, it works at the group level (4.8.2)—that is, you can see what's beneath the box, but you cannot see the hidden sides of the box itself. To be able to see the hidden sides, lower the opacity of individual sides by selecting them separately, as shown in Figure 11-18.

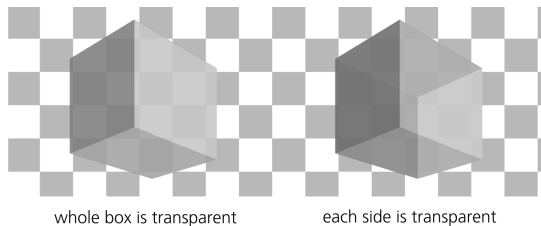

Figure 11-18: Opacity on the whole box vs. on individual sides

The *z-order* of sides within a box is automatically correct from the 3D viewpoint—that is, the sides that are supposed to be farther away from you are at the bottom, and the front sides are at the top of the *z-order*. However, the *z-order*

of different boxes is not enforced by Inkscape in any way; like any other shape tool, the 3D Box tool creates a new box on top of the current layer's z-order (4.4). Therefore, after drawing a box, you may need to move it in the z-order stack relative to other boxes for the composition to look correct.

For newly created boxes, the tool offers the same choice between the last set style and the tool's own style (11.1.2)—but with a twist. By default, the 3D Box tool uses the last set style, but unlike all other tools, it remembers the style last set on *the same side of a 3D box*, not on any object. For example, if you paint the top side of any box red, the top sides (but not the other sides) of all new boxes you create afterward will be red.

Since a 3D scene typically assumes a single light source, this behavior makes sense. Draw a single box and paint its sides as they would look when lit from, for example, the top-left corner. After that, all new boxes you create will be “lit” in a similar way.

NOTE

This tool remembers the last set style only when you assign it to individual sides, not the entire box. For example, if you just select a box and paint it all red, new boxes will not honor this. If you want all new boxes to have stroke but no fill (“wireframe”), the easiest way to achieve this is to enter a box as a group (Ctrl-Enter), select all its sides (Ctrl-A), and assign the stroke and remove the fill on all of them at once.

The Tweak tool works on 3D boxes exactly as you would expect it to work on a bunch of paths (grouped or not). With path tweaking modes (12.6), once you distort the sides of a box, it ceases to be a 3D box and becomes a simple group. The Color Paint and Color Jitter modes, however, paint over boxes without destroying their 3D capability. It may make sense to enable only the hue and possibly saturation channels but not lightness (8.9.3), so that you can tweak the colors of boxes but preserve the relative lightness and darkness of their sides for the 3D effect, as shown in Figure 11 in the color insert.

11.4 Ellipses

An ellipse is a shape that can represent not only an *ellipse* or a *circle* but also an *arc* (a fragment of an ellipse or circle with a chord) or a *segment* (an arc plus two radii going from the ends of the arc and meeting in the center), as shown in Figure 11-19.

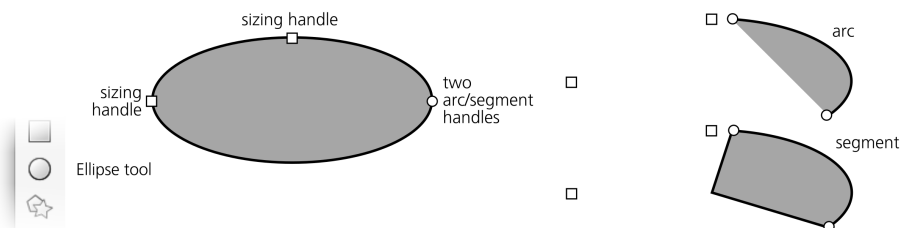

Figure 11-19: Handles on an ellipse, arc, and segment

11.4.1 Drawing

To switch to the Ellipse tool, press E or F5. Here are the ellipse drawing shortcuts:

- Dragging on the canvas creates an ellipse inscribed into the (imaginary) rectangle that your drag creates.
- With Ctrl, that imaginary rectangle is first restrained to a square or an integer ratio (1:2, 2:1, and so on), and then the ellipse is inscribed into it.
- With Shift, drawing starts from the center, so *one quarter* of an ellipse is inscribed into this rectangle instead of the whole ellipse. With both Ctrl and Shift pressed, you get a circle or an integer-ratio ellipse starting from the center (Figure 11-20).

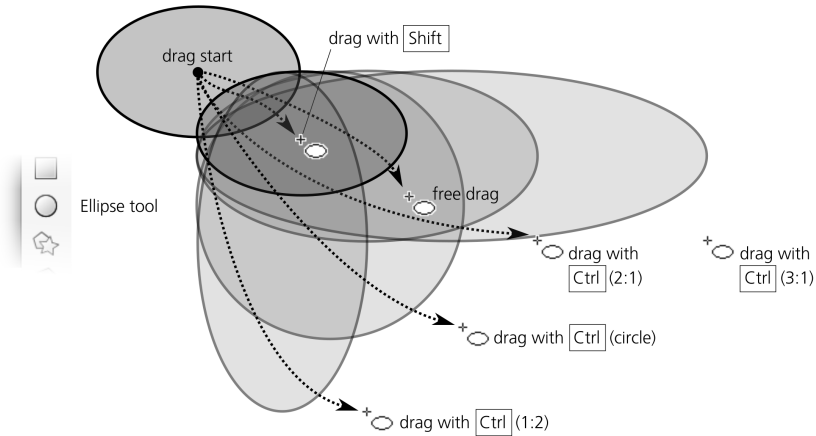

Figure 11-20: Drawing ellipses without Alt

- With Alt, the behavior of the tool changes (see Figure 11-21). Now it draws an ellipse whose *diagonal* goes from the start to the end points of your mouse drag. In other words, you start your drag in the 10:30 clock position on the ellipse and end at the 4:30 point, and the ellipse is squeezed as needed to fit this diagonal.

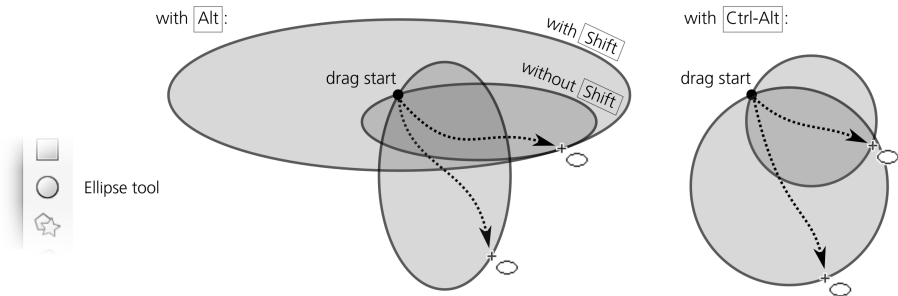

Figure 11-21: Drawing ellipses with Alt

- With Ctrl-Alt, the tool always draws a perfect circle, with its diameter stretching from the drag start to drag end. This is convenient if you need a circle with a given diameter.
- Adding Shift to Alt and Ctrl-Alt works the same as without Shift but begins drawing from the center—in other words, it creates a circle with a given *radius*.

One way to create circles of a fixed size quickly is by Ctrl-clicking in the Pen tool in the Straight lines or Paraxial mode (14.1.4). You can set the size of these circles on the Preferences page for the Pen tool. Add Shift to make them twice that size, or Alt to randomize their sizes, as shown in Figure 11-21.

11.4.2 Handles

Upon creation, an ellipse displays four handles: two square ones (top and left), a round one (right), and an X-shaped one (center). Just as with rectangles, the square handles are the sizing handles, and the round handle is in fact two handles sitting on top of one another. In ellipses, however, they're not for rounding but for turning an ellipse into an arc or segment, as you'll see shortly. The X-shaped handle moves the entire ellipse and is used for center snapping (7.3.1.3).

As with rectangles, the sizing handles of an ellipse change the ellipse's width and height *in the ellipse's own coordinates* instead of the document coordinates. No matter how you rotate or skew your ellipse, these handles remember the position of both axes of the ellipse and let you stretch or squeeze the ellipse with respect to those intrinsic axes, always preserving the position of the center, as shown in Figure 11-22.

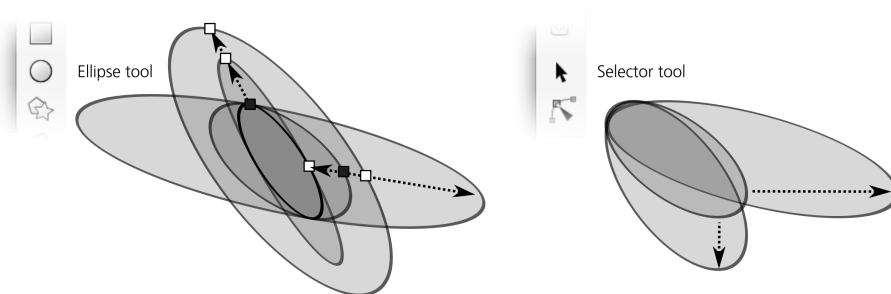

Figure 11-22: Transforming ellipses in the Selector and by the sizing handles

Here are the shortcuts of the ellipse sizing handles:

- Drag with Ctrl to turn an ellipse into a circle by making the other radius the same.
- Ctrl-click a handle to turn an ellipse into a circle without dragging. Note that the circle may still appear elliptic if skewing was applied to it.

Now let's look at the arc/segment handles—the round ones. To make a segment (an arc plus two radii), drag one or both of these handles *outside* the ellipse; to make an *arc*, drag while remaining *inside* it. Of course, the handle itself remains neither inside nor outside but exactly on the edge of an ellipse; the

phrase “drag inside” refers to where your mouse goes while you have that handle grabbed. Note that the sizing handles still work and remain in the same positions as for a whole ellipse (which may be outside your arc or segment).

The controls bar of the Ellipse tool lets you specify the exact angles of an arc, turn it into a segment, and make the ellipse whole (Figure 11-23).

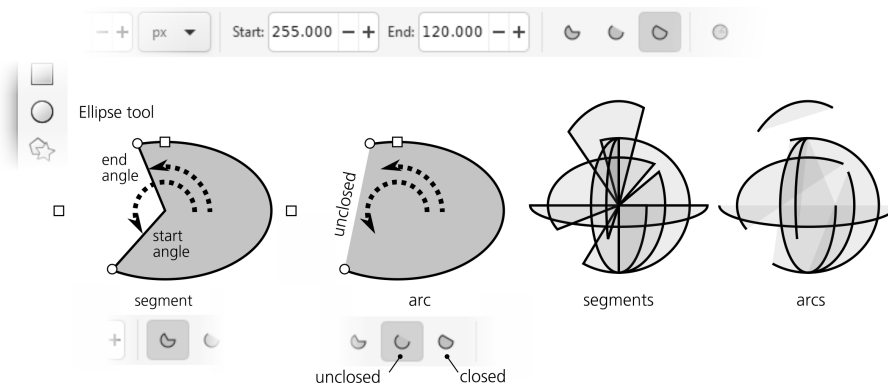

Figure 11-23: Segments and arcs

Note that unlike segments (which are always closed), arcs can be either *closed* or *unclosed*. An unclosed arc has the stroke going along the ellipse’s edge but does not connect the ends of the arc (you can make this obvious if you remove the fill, leaving only the stroke). Use one of the two arc buttons on the controls bar to switch an arc between closed and unclosed.

Here are the arc/segment handle shortcuts:

- With Ctrl pressed, snap the handle to angle increments (15 degrees by default, 6.3) when dragging.
- Shift-click a handle to turn an arc or segment into a whole ellipse.

Like all other shape parameters, start and end angles of an ellipse are remembered and reused for newly created shapes. It may be a surprise when you intend to draw an ellipse and get a narrow pie slice instead because you’ve recently turned some other ellipse into a segment.

11.5 Stars and Polygons

The Star tool (the * key or Shift-F9) creates two slightly different kinds of rotationally symmetric shapes: polygons and stars (Figure 11-24). Despite the simplicity of the idea, this is one of the most entertaining tools in Inkscape—perfect for wowing your friends!

A *polygon* is formed by a number of equidistant points lying on an imaginary circle and connected by segments. An Inkscape polygon has one diamond-shaped handle used to scale and rotate it, as well as control the shape of the connecting segments.

A *star* is a more interesting shape. It has two sets of equidistant points on two imaginary concentric circles, with the outline of the star zig-zagging back and forth between points on the inner and outer circles. Using a star’s two

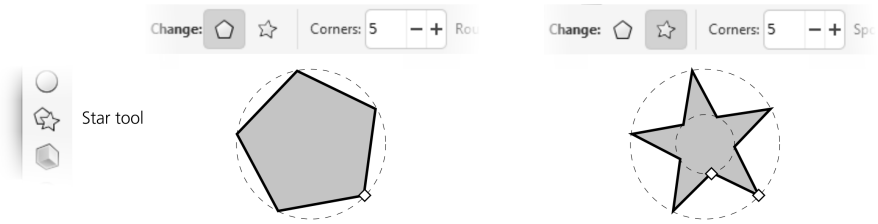

Figure 11-24: A polygon and a star

handles, you can vary the diameters of the circles and rotate the circles relative to one another around their common center, which produces a fascinating variety of symmetric shapes.

11.5.1 Drawing

Before you draw a new shape, decide whether you want a polygon or a star by pressing one of the toggle buttons on the controls bar, and choose the number of corners (convex vertices) in the numeric control. For example, a polygon with three corners is an equilateral triangle that will have three nodes if converted to path; a star with three corners, however, will have six nodes. You can always change the polygon/star type and the number of corners in an existing shape, too—just select it and edit the values.

The minimum **Corners** value is 2 for stars and 3 for polygons. A three-cornered polygon is, of course, a triangle, whereas a two-cornered star creates rhombuses or parallelograms.

NOTE

*The maximum value for **Corners** is 1,000, but if you set it too high, it may slow down Inkscape unless you use the **Outline mode** (3.14).*

Drawing a shape is, again, as simple as dragging your mouse upon the canvas. A star or polygon is always drawn starting from its center. There's only one keyboard shortcut: dragging with **Ctrl** snaps the angle of one of the shape's corners relative to its center to 15-degree increments.

11.5.2 Handles

Dragging a polygon's diamond-shaped handle scales and rotates the polygon—something you can do just as well by transforming it in the Selector. The two handles of a star are more interesting.

First, by moving one of them closer or farther from the center of the star, you are changing the ratio of the diameters of the two circles on which the corners of the star lie. This ratio is called the *spoke ratio* and is also adjustable as a numeric parameter (disabled for polygons) in the controls bar (Figure 11-25).

You can even move the original inner handle farther away from the center than the outer one. The control will still show a ratio less than 1 because it always divides the smaller radius by the larger, regardless of which of them was initially inner or outer.

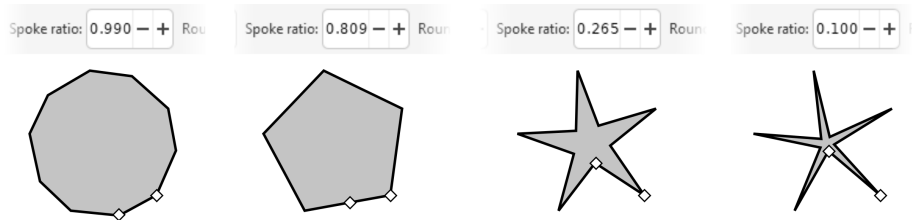

Figure 11-25: Adjusting the spoke ratio of a 5-vertex star

Then, the inner handle (initially on the inner circle) can be moved *tangentially*—along an arc around the star center—to skew the star’s vertices, as shown in Figure 11-26. (Rotating the outer handle simply rotates the entire star.)

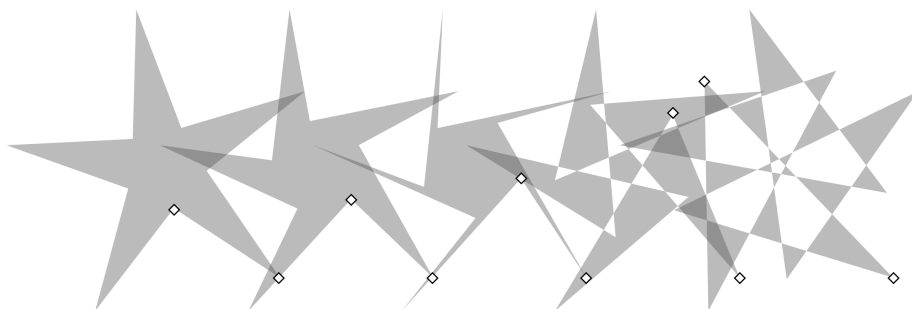

Figure 11-26: Moving the inner handle of a star tangentially

Drag the inner handle with Ctrl if you want to keep the vertices strictly radial (no tangential displacement), or Ctrl-click it to remove any existing tangential skew without dragging.

11.5.3 Rounding

You can create fascinating effects with a star or polygon by *rounding* it. This is different from rounding the corners of a rectangle; with a star or polygon, not only do the corners lose sharpness but the sides of the shape also bend into elegant Bézier curves (Figure 11-27).

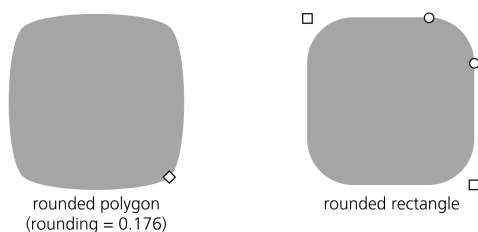

Figure 11-27: A rounded 4-sided polygon compared to a rounded rectangle

Note that a rounded square has straight line segments between circular or elliptic rounded corners. However, a rounded polygon or star has no straight lines at all—all of its segments become Bézier curves.

The Rounded numeric control of the Star tool is the ratio of the length of each Bézier handle (12.1.4) to the length of the polygon/star side that this handle affects. This parameter can be negative, which reverses the direction of tangents. Typically, values between 0.2 and 0.4 give the most natural-looking results. Values that are negative or too high positive may result in twisting, looping, and self-intersections. By varying this value, you can get an infinite variety of beautiful shapes, as shown in Figure 11-28.

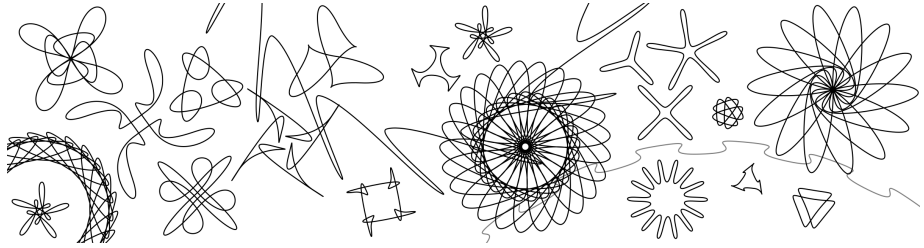

Figure 11-28: Fun with rounded stars

Apart from the numeric rounding parameter on the controls bar, you can round by Shift-dragging any of the handles tangentially. For positive rounding, rotate a handle counterclockwise around the star's center; rotate clockwise for negative rounding. Shift-clicking a handle removes any rounding.

If you want the outer corners of a star to be sharp but the inner ones smoothed, or vice versa, try creating an offset path (12.4) from the star.

11.5.4 Randomizing

Yet another way to make a star interesting is by *randomizing* it. Randomization moves all vertices of a star or polygon in random directions by random distances. If the star was rounded, randomization preserves the smoothness of all vertices.

The **Randomized** parameter in the controls bar controls the overall force of the effect. It can take positive and negative values. As you change this value—or simply Alt-drag a star's handle tangentially—the direction of random displacement for each node remains the same, and only the distance changes; a negative value simply moves the vertex in the opposite direction. In other words, the star remains randomized in the same way but to a varying extent.

By contrast, when you simply drag a randomized star's handle to scale or reshape it, or when you draw a new star with nonzero randomization, the shape trembles and jitters, abruptly changing the random displacements for all nodes (in mathematical terms, *reseeding* the randomization) with the slightest move of your mouse. So, if you want your star to become randomized differently but with the same overall amplitude, simply drag any of its handles slightly, as shown in Figure 11-29.

What are randomized stars good for? Randomness is a fundamental principle of nature, and randomness in design is a great way to make things look less rigid and more natural. Your artistic sense will tell you where and how much randomness is appropriate. Inkscape offers many sources of artistic randomness: you can shuffle the positions of objects (7.5.2), create patterns with random placement, scaling, and rotation (16.6), as well as randomly displace nodes in paths

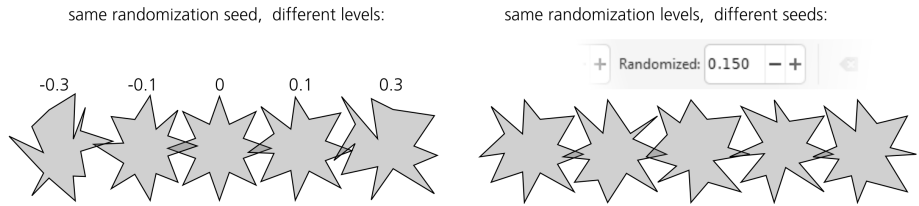

Figure 11-29: Randomizing stars

to distort them (12.6.6). Still, randomized stars are unique in how easy it is to create a shape whose intrinsic symmetry emphasizes its randomness.

Slight randomization makes a star more lively—sometimes outright funny. Strong randomization produces a variety of wild and unpredictable shapes—messy hairballs, rounded amoeba-like ink blotches, fantastic landscapes at the edge of a large star with many vertices and spoke ratio close to 1. As an example, Figure 11-30 shows a star with 500 vertices, not randomized (left) and randomized by just 0.005 (right) to look more naturally hairy and to get rid of the moiré pattern.

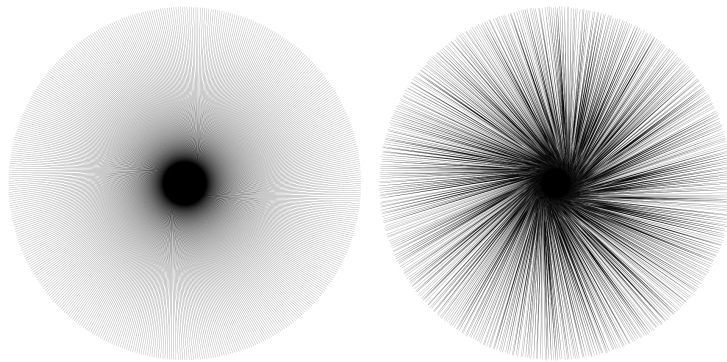

Figure 11-30: A 500-vertex star without randomization (left) and randomized by 0.005 (right)

As another example, here is a random but unclumped (7.5.2) scattering of pentagons, rounded at 0.28 and randomized at 0.15, looking very much like pebbles on a beach, as Figure 11-31 demonstrates.

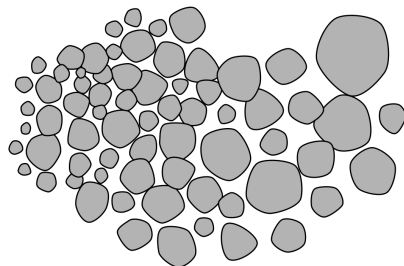

Figure 11-31: Pebbles: an unclumped scattering of rounded and randomized pentagons

11.6 Spirals

The Spiral tool (the I key or F9) creates another simple but versatile shape: a *concentric spiral*. Both as a drawing aid and as a shape in its own right, a spiral may be very useful—and no less exciting than a star.

A spiral, like a star, is drawn from the center. Dragging with Ctrl, as usual, snaps the drag point (the outer end of the spiral) to 15-degree increments (6.3). Unlike all other shape tools, the Spiral tool by default creates new spirals with its own style—no fill, black 1 px stroke—instead of the last used style (11.1.2).

Once drawn, a spiral displays two handles on both ends of the line. Simply dragging these handles circularly rolls the spiral in or out—from the inside or from the outside. In this way, you can, for example, create a spiral with only one turn.

The Turns parameter on the controls bar indicates how many full circles your spiral makes from the center to the outer end. The maximum number of spiral turns is 1000. The Inner radius value controls the inner end; it gives the percentage of the total turns where the spiral starts (Figure 11-32). For example, an Inner radius of 0 means that the spiral starts right in the center; 0.5 means that it starts half-way between the center and the outer end.

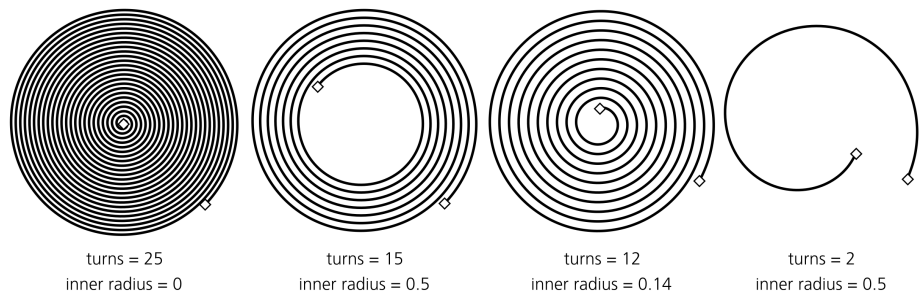

Figure 11-32: Adjusting the number of turns and the inner radius

The Divergence of a spiral controls whether a spiral's winding is equispaced throughout (divergence = 1), becomes denser toward its center (divergence > 1), or becomes denser toward the periphery (divergence < 1). You can change this parameter either numerically via the controls bar or by Alt-dragging the inner handle up or down, as shown in Figure 11-33.

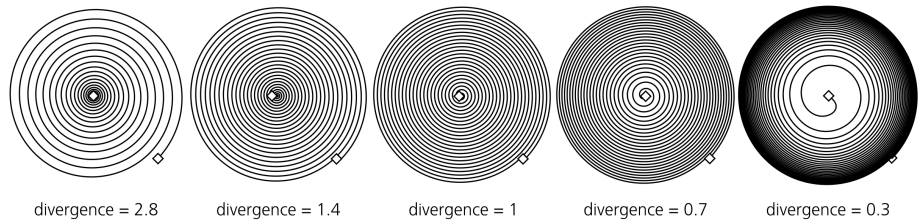

Figure 11-33: Adjusting divergence

Here are the other shortcuts for the outer handle:

- Shift-drag to scale or rotate around the center (no rolling on unrolling); this is the same behavior as when drawing the spiral.
- Alt-drag to lock the radius while rolling or unrolling. This way, the entire spiral becomes denser or sparser without changing its overall size.

Inner handle shortcuts include:

- Alt-drag vertically to adjust divergence.
- Alt-click to reset divergence to the default of 1.
- Shift-click to reset the inner radius to 0 (that is, move the inner handle all the way to the center).

When does it make sense to use spirals? A spiral fills a given space with a uniform concentric pattern—something that may not be easy to achieve manually or using any other tools. It may therefore serve as a drawing guide or carrier for other objects, such as markers (9.5.1), dash patterns (9.4), text on path (15.2.4), or live path effects (Chapter 13). Also, like the Ellipse tool, the Spiral tool can be convenient for creating curves with smoothly varying curvature; unlike with a plain Bézier curve, you can make an arc or a spiral shorter or longer by dragging a handle *along* the curve without affecting its shape.