



Focused Forecasts: Attention Maps for AtmoRep- large-scale representation learning of atmospheric dynamics

Student: David Hidary

Supervisors: Iaria Luise, Christian Lessig, Alberto di Meglio

Openlab Summer Student Programme 2023

STORM TEAM 4 

FEELS LIKE
RIGHT NOW

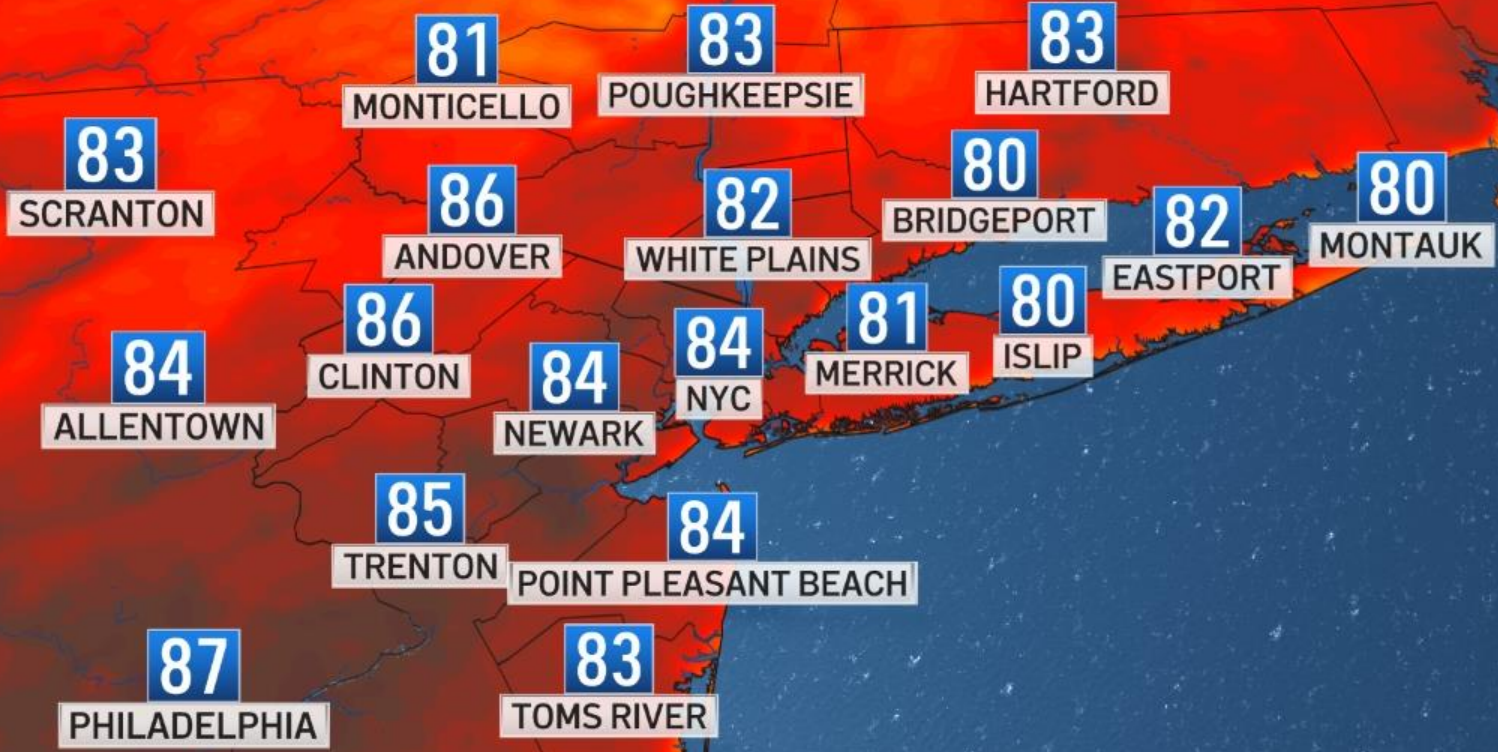

The Model

AtmoRep

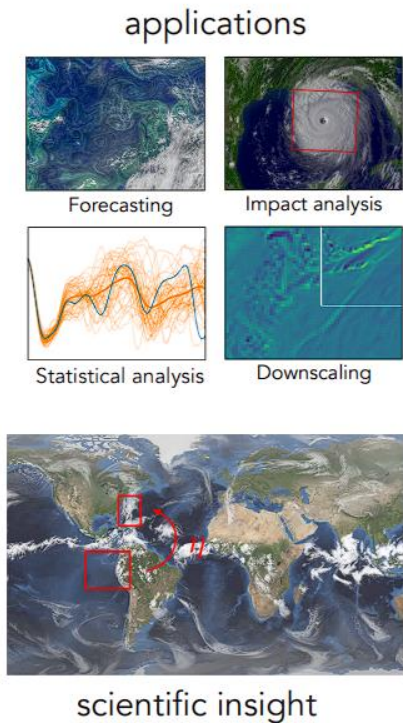
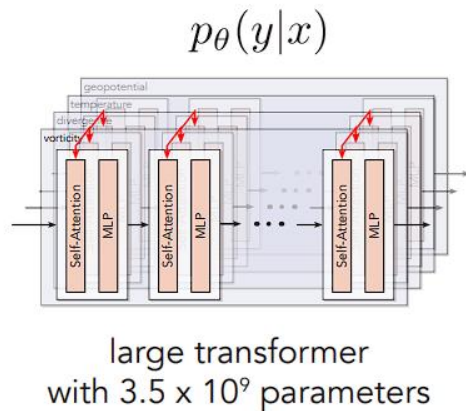
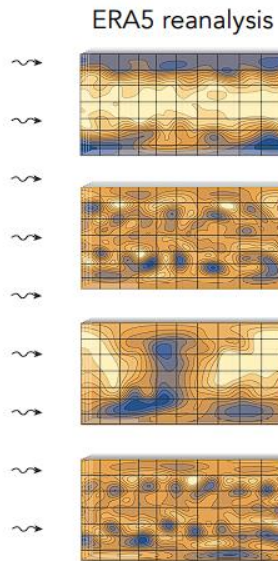

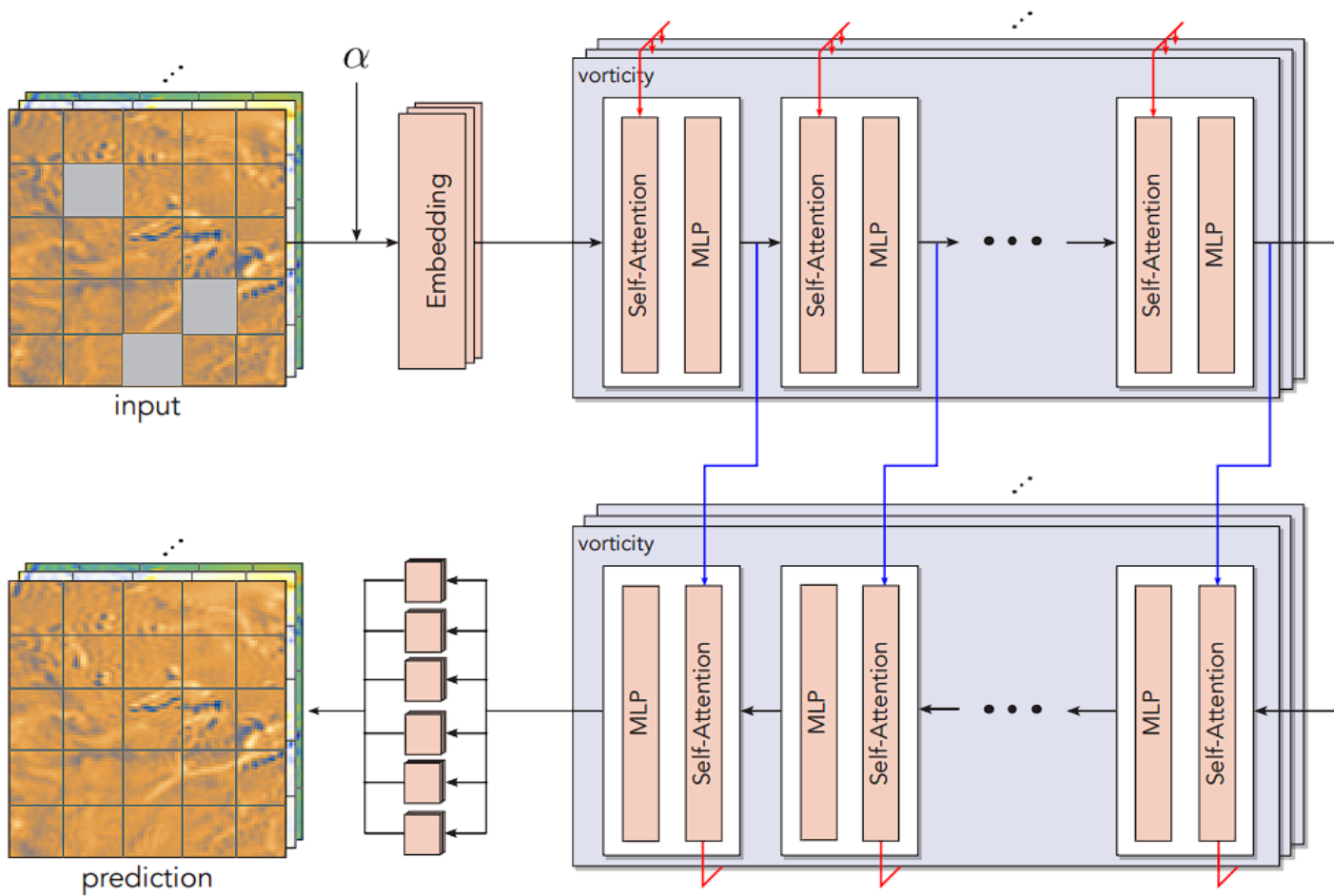

Scaled Dot-Product Attention

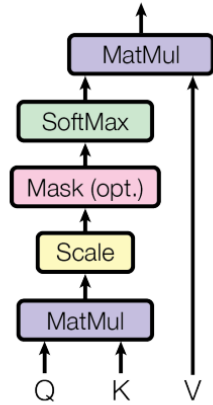

Multi-Head Attention

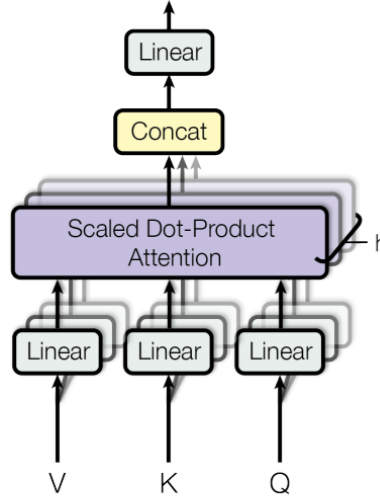

$$\text{Attention}(Q, K, V) = \text{softmax}\left(\frac{QK^T}{\sqrt{d_k}}\right)V$$

Let's look at attention maps for this project!

<https://www.atmorep.org/attention/attention.html>

	My	Name	Is	David
My				
Name				
Is				
David				