



Mechanical design of superconducting magnets

Fernando Toral
Accelerator Technology Group
CIEMAT, Madrid, Spain



GOBIERNO
DE ESPAÑA

MINISTERIO
DE CIENCIA
E INNOVACIÓN

Ciemat
Centro de Investigaciones
Energéticas, Medioambientales
y Tecnológicas



Copyright statement and speaker's release for video publishing

The author consents to the photographic, audio and video recording of this lecture at the CERN Accelerator School. The term “lecture” includes any material incorporated therein including but not limited to text, images and references.

The author hereby grants CERN a royalty-free license to use his image and name as well as the recordings mentioned above, in order to post them on the CAS website.

The material is used for the sole purpose of illustration for teaching or scientific research. The author hereby confirms that to his best knowledge the content of the lecture does not infringe the copyright, intellectual property or privacy rights of any third party. The author has cited and credited any third-party contribution in accordance with applicable professional standards and legislation in matters of attribution.

Outline

- Motivation
- Basic concepts
- Solenoids
- Accelerator magnets
- Toroids
- Application case
- Measurement techniques

References

BOOKS

- [1] S. Timoshenko, "*Strength of materials*", New York, D. Van Nostrand Company, 1930.
- [2] M. Wilson, "*Superconducting magnets*", Oxford, Clarendon Press, 1983.
- [3] Y. Iwasa, "*Case studies in superconducting magnets*", New York, Plenum Press, 1994.
- [4] W. Young, R. Budynas, A. Sadegh, "Roark's Formulas for Stress and Strain", Mc Graw Hill, 2011

SCHOOLS

- [5] H. Felice, P. Ferracin, S. Prestamon, E. Todesco, "*Superconducting magnets for particle accelerators*", USPAS, 2011. Units 10, 14 and 19. See USPAS web page.
- [6] "*Superconductivity in particle accelerators*", CERN-96-03 Report.
- [7] C.L. Goodzeit, "*Superconducting Accelerator Magnets*", USPAS, January 2001
- [8] E. Todesco, "*Masterclass - Design of superconducting magnets for particle accelerators*", <https://indico.cern.ch/category/12408/>, 2020

Special thanks to my colleagues at CIEMAT

Why is mechanics important for magnets?

- Superconducting accelerator magnets are characterized by large fields and large current densities.
- As a result, coils experience large stresses.
- Those forces have three important effects:
 - 1. Quench triggering:** the most likely cause is the release of stored elastic energy or AC losses when part of the coil moves or a crack suddenly appears. Due to the low heat capacity of materials at low temperatures, that energy is able to increase the temperature of the superconductor above its critical value.
 - 2. Mechanical degradation,** both the coil or the support structure: if the applied forces/pressures are above a given threshold (yield strength), plastic deformation of the materials takes place.
 - 3. Field quality:** the winding deformation may affect the field quality.

Objectives of the mechanical design

- The magnet parts are produced and assembled at room temperature, but working temperature is about -270°C : *differential thermal contractions*.
- Taking into account the aforementioned risks, the mechanical design will **aim**:
 - To avoid tensile stresses in the superconductor.
 - To avoid mechanical degradation of the materials.
 - To study the magnet life cycle: assembly -> cooling-down -> powering -> quench.
- In short: mechanics is the most likely limiting agent which prevents a magnet to reach its nominal performance.
- One should always think of the way to be **manufactured**.

Mechanical design strategy

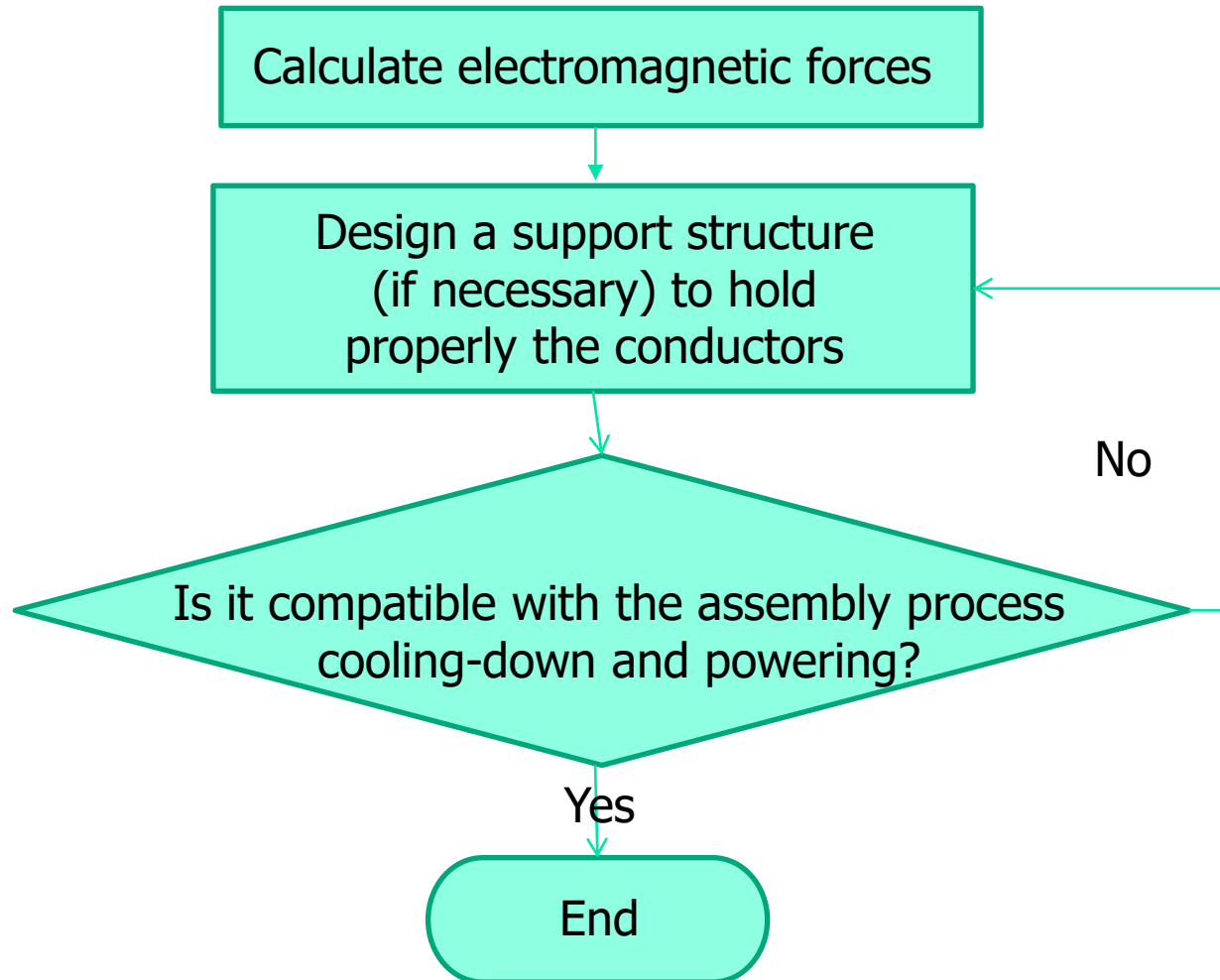

Outline

- Motivation
- Basic concepts:
 - Electromagnetic force, magnetic energy and pressure.
 - Stress, strain, Hooke's law, Poisson's ratio, shear modulus.
 - Material properties: Young's modulus, thermal contraction, failure criteria.
- Solenoids
- Accelerator magnets
- Toroids
- Final example
- Measurement techniques

Electromagnetic force

- A charged particle q moving with speed v in the presence of an electric field E and a magnetic field B experiences the **Lorentz force**:

$$\vec{F}[N] = q(\vec{E} + \vec{v} \times \vec{B})$$

- A conductor element carrying current density j in the presence of a magnetic field B will experience this **force density**:

$$\vec{f}_L[N/m^3] = \vec{j} \times \vec{B}$$

- The Lorentz force is a **body force**, that is, it acts on all the parts of the conductor, like the gravitational force.

$$\vec{F}_L[N] = \iiint \vec{f}_L dv$$

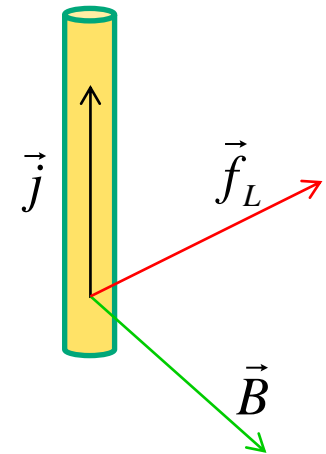
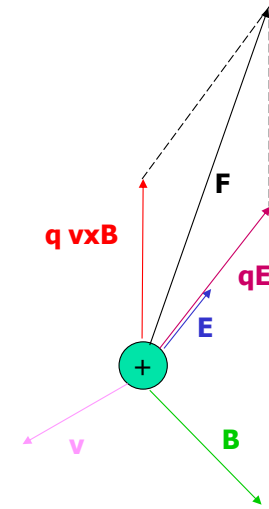

Magnetic energy and pressure

- The **magnetic energy density** u stored in a region without magnetic materials ($\mu_r=1$) in presence of a magnetic field B is:

$$u[J/m^3] = \frac{\vec{B} \cdot \vec{H}}{2} = \frac{B^2}{2\mu_0}$$

- The **total energy** U can be obtained by integration over all the space, by integration over the coil volume or by knowing the so-called **self-inductance** L of the magnet:

$$U[J] = \iiint_{all} \frac{\vec{B} \cdot \vec{H}}{2} dv = \iiint_{coil} \vec{A} \cdot \vec{j} dv = \frac{1}{2} LI^2$$

- The stored energy density may be seen as a "**magnetic pressure**" p_m (force on a surface). In a current loop, the magnetic field line density is higher inside: the field lines try to expand the loop, like a gas in a container.

$$p_m[N/m^2] = \frac{B^2}{2\mu_0}$$

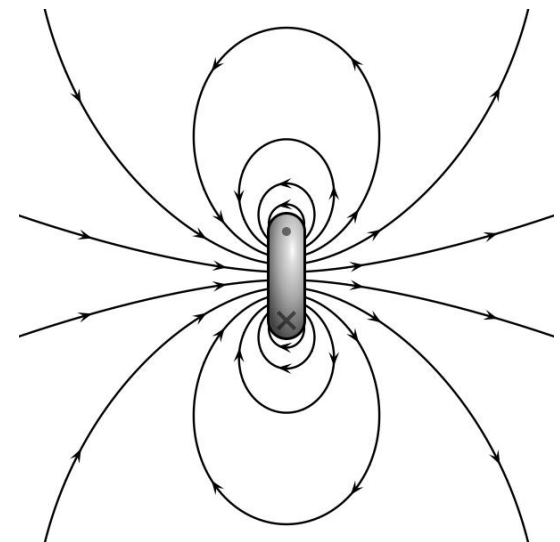

Stress

- In continuum mechanics, **stress** is a physical quantity that expresses the internal pressure that neighboring particles of a continuous material exert on each other.
 - When the forces are perpendicular to the plane, the stress is called **normal stress** (σ) ; when the forces are parallel to the plane, the stress is called **shear stress** (τ).
 - Stresses can be seen as way of a body to resist the action (compression, tension, sliding) of an external force.

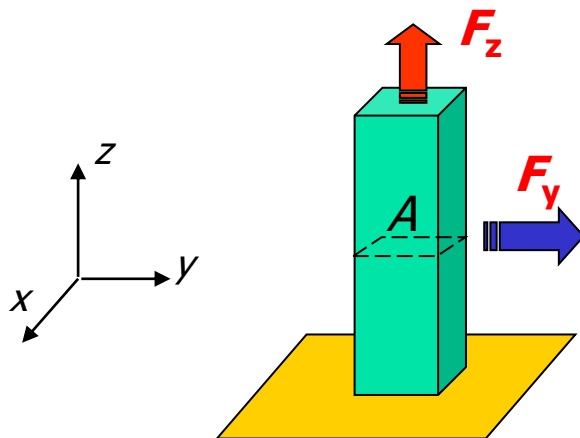

$$\sigma [Pa] = \frac{F_z}{A} \left[\frac{N}{m^2} \right]$$

$$\tau_{xy} [Pa] = \frac{F_y}{A} \left[\frac{N}{m^2} \right]$$

Strain and Hooke's law

- A **strain** ε is a normalized measure of deformation representing the displacement δ between particles in the body relative to a reference length l_0
$$\varepsilon = \frac{\delta}{l_0}$$
- **Hooke's law** (1678): within certain limits, the strain ε of a bar is proportional to the exerted stress σ . The constant of proportionality is the elastic constant of the material, so-called **modulus of elasticity** E or **Young's modulus**.

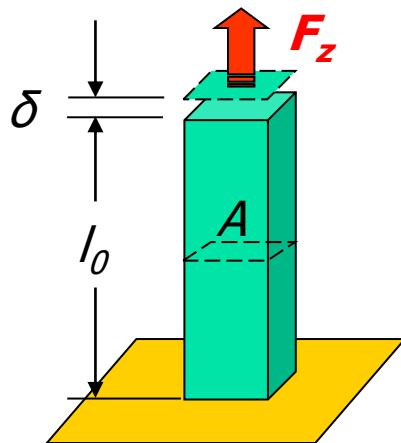

$$\varepsilon = \frac{\delta}{l_0} = \frac{\sigma}{E} = \frac{F}{AE}$$

Question: what is the strain of a st. steel square beam of 10 mm side under 1 ton force?

$$\varepsilon_{steel} = \frac{10^4}{10^{-4} \cdot 210 \cdot 10^9} = 4.8 \cdot 10^{-4}$$

Tensile (pulling) stress (+): elongation
Compressive (pushing) stress (-): contraction

Poisson's ratio & shear modulus

- The **Poisson's ratio** ν is the ratio between "transversal" to "axial" strain. When a body is compressed in one direction, it tends to elongate in the other direction. Vice versa, when a body is elongated in one direction, it tends to get thinner in the other direction. Typical value is around 0.3.

$$\nu = -\frac{\varepsilon_{transversal}}{\varepsilon_{axial}}$$

- A **shear modulus** G can also be defined as the ratio between the shear stress τ to the shear strain γ .

$$G = \frac{\tau_{xy}}{\gamma_{xy}} = \frac{E}{2(1 + \nu)}$$

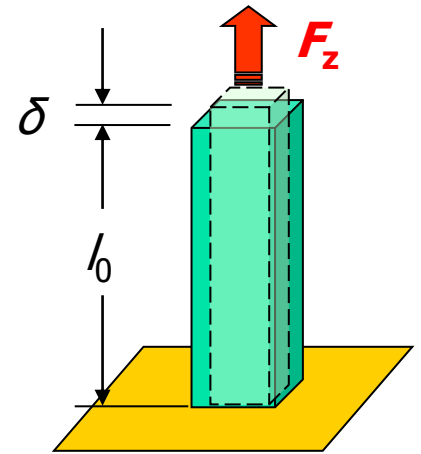

Some common material properties

MATERIAL (@ 4.2 K)	YOUNG MODULUS (GPa)	POISSON RATIO	SHEAR MODULUS (GPa)	CONTRACTION @296-4,2K	Sources (thermal prop: http://cryogenics.nist.gov)
NbTi	77	0.3	20	1.87e-3	<i>Case Studies un Superconducting Magnets, Y.Iwasa</i>
NbTi+Cu	125	0.3	48	2.92e-3	<i>Handbook of Accelerators Physics and Engineering, M.Wu</i>
Copper	138	0.34	52	3.15e-3	<i>Cryogenic engineering, T.M. Flynn</i>
Insulation	2.5	0.35	0.93	10.3e-3	<i>Formvar ®</i>
Epoxy	7	0.28	2.75	6.40e-3	<i>Composites Handbook, INTA</i>
AISI 1010*	205	0.29	80	--	http://www.matweb.com (*properties at 300 K)
316L	208	0.30	82	2.97e-3	<i>Handbook of Applied Superconductivity, B.Seeber</i>

- In some cases, important differences depending on the **data source**, mainly for non-metals.
- More uncertainties on properties at **low temperature**.
- Very useful for a magnet designer to know rough values **by heart**.

Young's modulus of composites

- It is quite often that data is not available for **composites**.
- An **impregnated** superconducting coils is a mixture of strands, insulation and resin, in custom proportions.
- **Smeared-out** properties are computed, since they are more easily handled in the calculations.

WINDING SMEARED-OUT PROPERTIES (4.2 K)

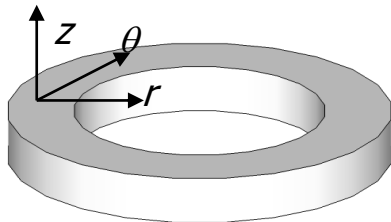

Courtesy J. Munilla, CIEMAT

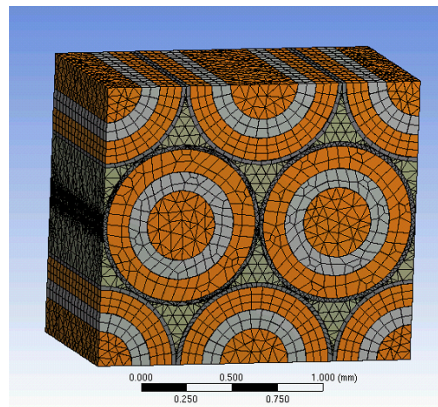

	YOUNG MODULUS (GPa)	POISSON RATIO	SHEAR MODULUS (GPa)	CONTRACTION @296-4.2K
θ	94			2.99E-3
r	35			3.90E-3
z	35			3.93E-3
$r\theta$		0.08		
$z\theta$		0.08		
rz		0.35	24	

Material properties: thermal contraction

- The magnet **assembly** is always made at room temperature.
- One needs to analyze the induced stresses due to **different contraction** of joined parts during cooling down and at cold working temperature.
- Composites are usually **anisotropic** materials.
- One should be very careful during cooling down... and **warming up!!!**

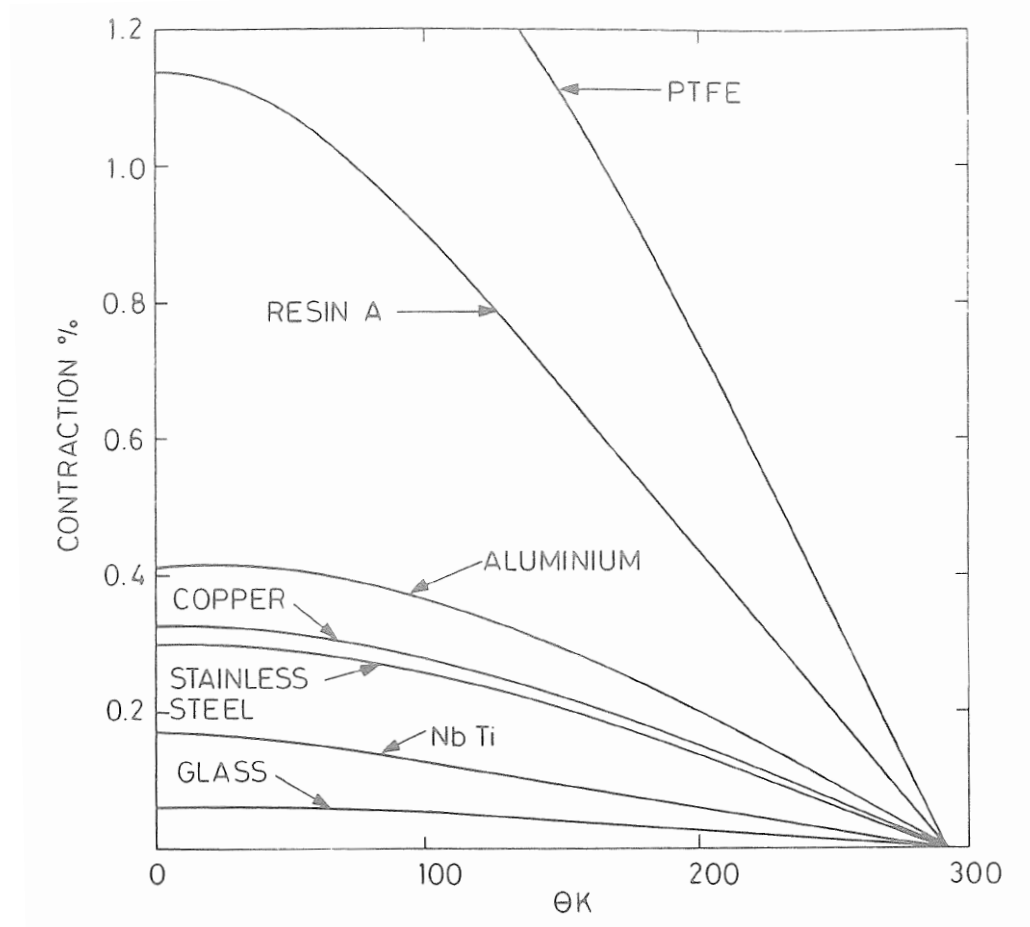

M. Wilson [2]

Failure criteria

- The proportionality between stress and strain is more complicated than the Hooke's law:

- A: limit of proportionality (Hooke's law)
- B: yield point
 - Permanent deformation of 0.2 %
- C: ultimate strength
- D: fracture point

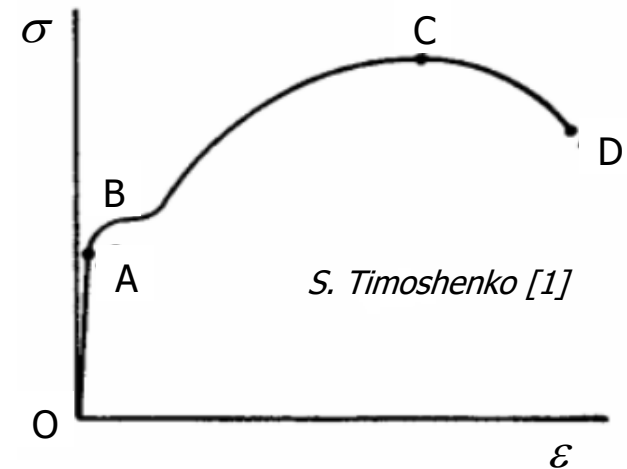

- Several failure criteria are defined to estimate the failure/yield of structural components, as

- Equivalent (**Von Mises**) stress $\sigma_v < \sigma_{yield}$, where

$$\sigma_v = \sqrt{\frac{(\sigma_1 - \sigma_2)^2 + (\sigma_2 - \sigma_3)^2 + (\sigma_3 - \sigma_1)^2}{2}}$$

- Be **careful**: it is an **average** value. No information on direction or sign (tension/compression).

Material properties: NbTi

M. Wilson [2]

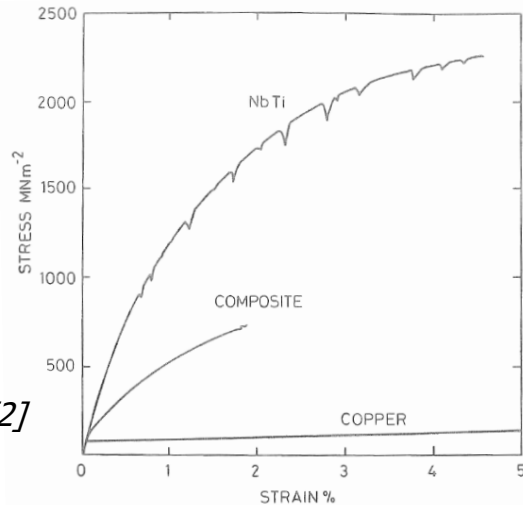

- **Ductile** material
- The properties can be computed as a **weighted average** in volume of copper and superconductor.
- Some **degradation** of critical current above 200 MPa, but reversible (non permanent).

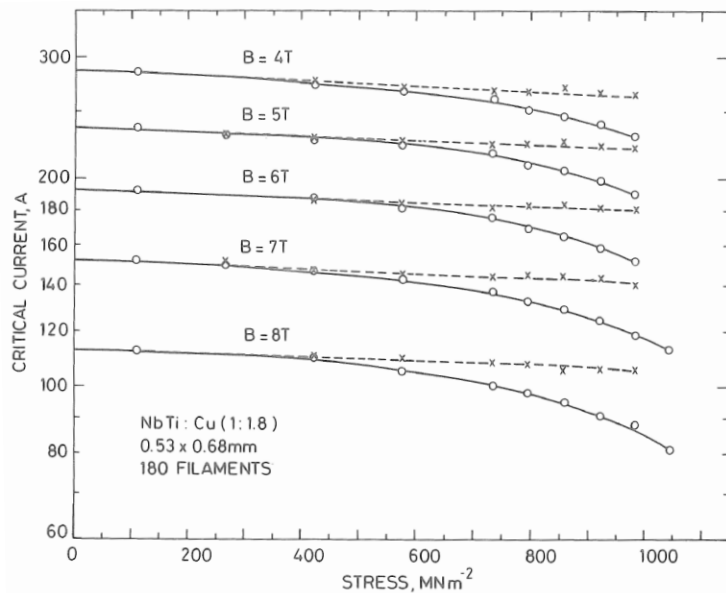

Material properties: Nb₃Sn

C. Senatore et al.
<https://doi.org/10.1088/1361-6668/acca50>

- **Fragile** material
- **Permanent degradation** of critical current above ~150 MPa (many studies ongoing).

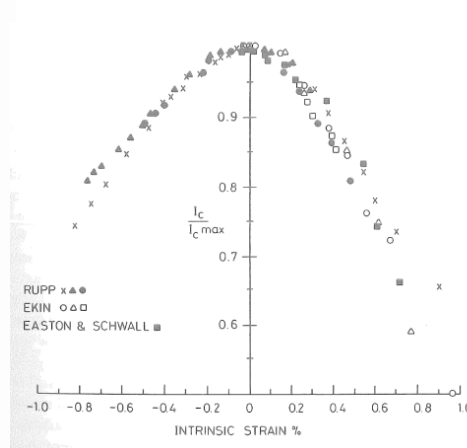
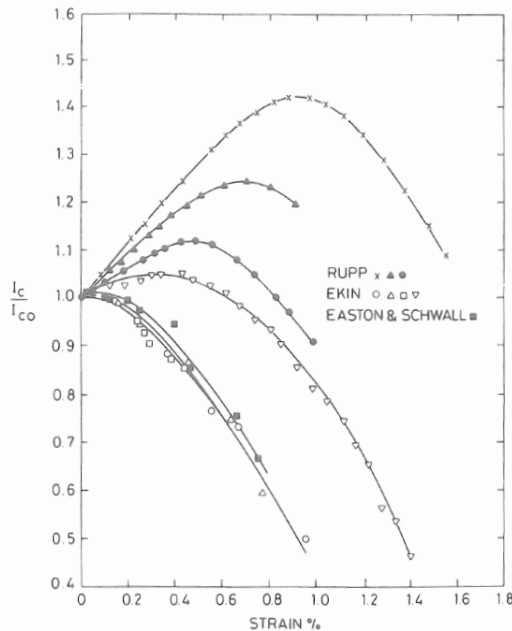

M. Wilson [2]

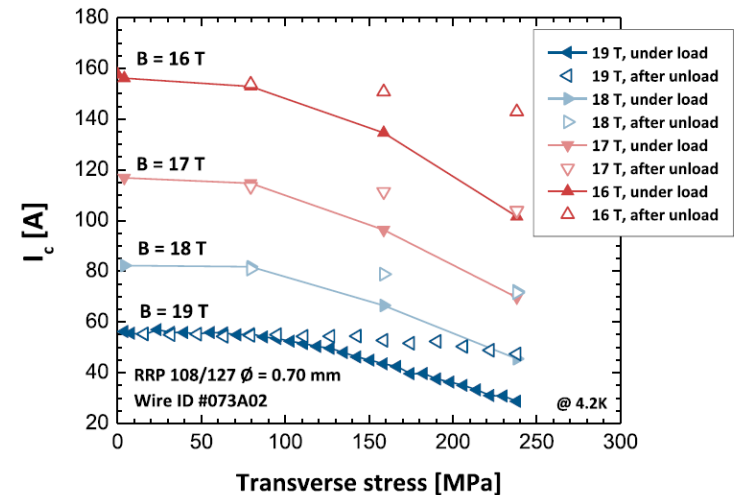
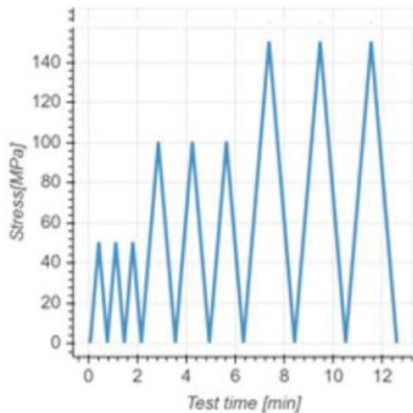

Figure 1. Dependence of the critical current I_c on the applied transverse stress for the 0.70 mm RRP wire impregnated with epoxy type L, at $T = 4.2$ K and $B = 16$ T, 17 T, 18 T and 19 T. Solid and open symbols correspond to the measurements under load and after unload, respectively.

- Tensile stress may increase the critical current... but due to an internal state of compression.
- No dependence on intrinsic strain.

Material properties: nonlinearities



*O. Sacristán (CERN)
EDMS #2706612
MCBXF impregnated
cables*

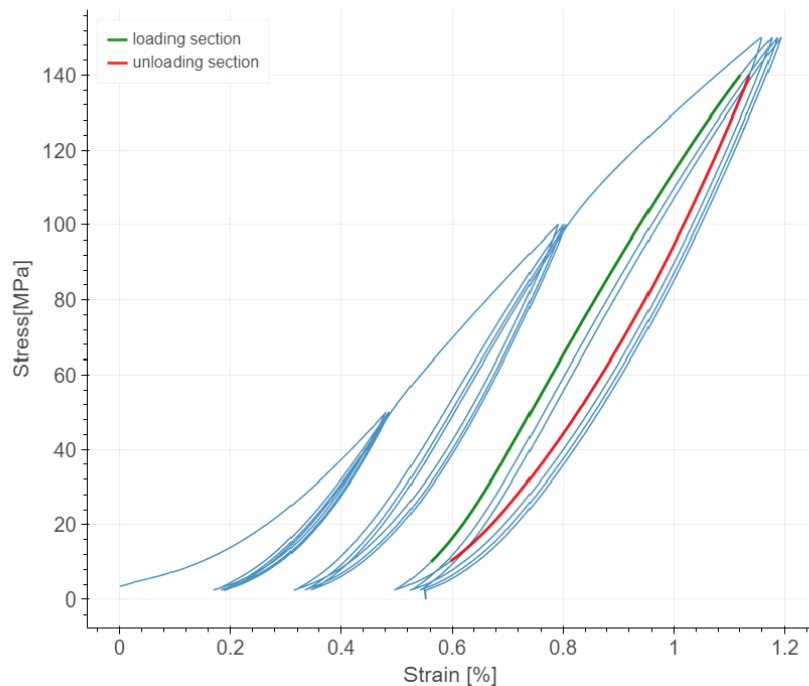

- In many cases, modulus of elasticity varies with applied stress: **nonlinearity**. Typically, it happens with impregnated superconducting cables!
- It also depends on **temperature**. Usually, rigidity increases at low temperature.
- **Virgin** loading is quite different from **cyclic** loading.
- Loading and unloading follows different paths: **hysteresis**.

Outline

- Motivation
- Basic concepts
- Solenoids:
 - Thin wall
 - Thick wall
 - Real case
- Accelerator magnets
- Toroids
- Final example
- Measurement techniques

Why starting with solenoids?

- It is the **simplest geometry**, it helps to understand the concepts.
- It can be studied **analytically**... numerical results have to be checked analytically!!
- It is also an **accelerator magnet**, used for focusing.
- Large magnet **detectors** are usually based on solenoids.
- Some other magnet layouts are based on solenoids: **Helmholtz coils**.

Solenoid: thin wall (I)

- In an **infinitely long solenoid** carrying current density j , the field inside is uniform and outside is zero. Lorentz forces are pushing the coil outwards in pure radial direction, creating a hoop stress σ_θ on the wires.
- Using Ampere's law:

$$\oint \vec{B} \cdot d\vec{l} = \mu_0 I \Rightarrow B_0 \Delta z = \mu_0 j w \Delta z$$

- Assuming that the average coil field is $B_0/2$, the magnetic pressure is given by the distributed Lorentz force:

$$F_{Lr} \vec{u}_r = f_{Lr} (a \Delta \theta \Delta z w) \vec{u}_r = j \frac{B_0}{2} (a \Delta \theta \Delta z w) \vec{u}_r = \sigma_B (a \Delta \theta \Delta z) \vec{u}_r$$

$$p_m = \frac{B_0^2}{2\mu_0}$$

- So, in a 10 T solenoid, the windings undergo a pressure of 398 atm.

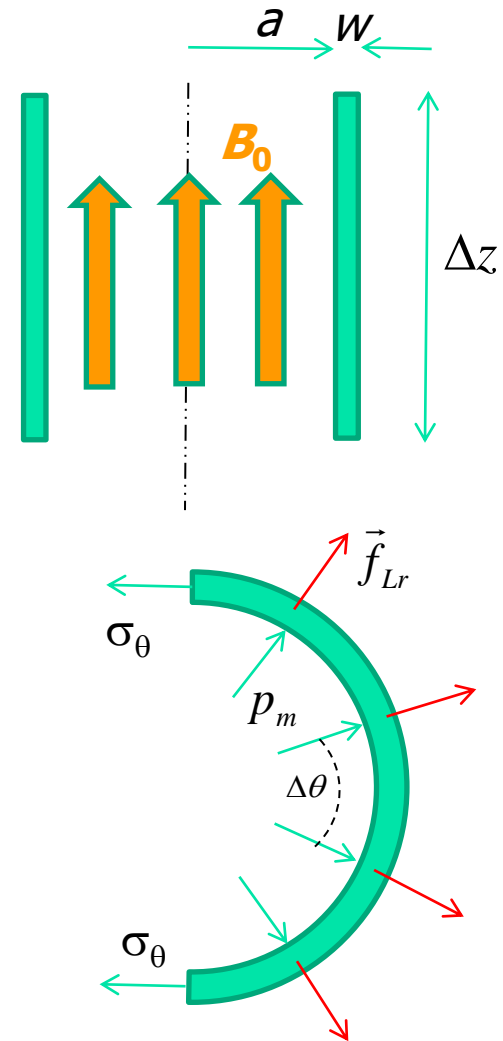

Solenoid: thin wall (II)

- The simplest stress calculation is based on the assumption that each turn acts independently of its neighbors:

$$2F = \int_{-\pi/2}^{\pi/2} f_{Lr} \cos \theta w a d\theta = 2 f_{Lr} a w$$

$$F = f_{Lr} a = p_m a \Rightarrow \sigma_{\theta} w = \frac{B_0^2}{2\mu_0} a \Rightarrow \sigma_{\theta} = \frac{B_0^2}{2\mu_0} \frac{a}{w} = p_m \frac{a}{w}$$

- In general, assuming that B is the field at the innermost turn, at radius a :

$$\sigma_{\max} = B J a \propto J^2$$

- In our example, assuming radius of 10 cm and thickness of 10 mm, stress is about 400 MPa. It is too high for Nb₃Sn (~150 MPa) and likely for NbTi (~500 MPa), if one takes a filling factor of 70% in the winding...
- What is the **solution**? To fit an external cylinder with interference, which makes a pre-stress on the winding, decreasing the tensile azimuthal stress σ_{θ} .

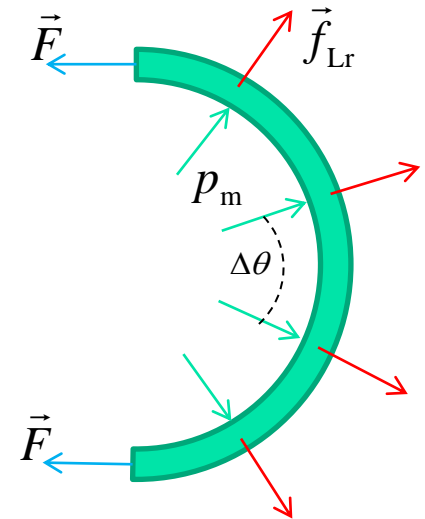

Solenoid: thick wall

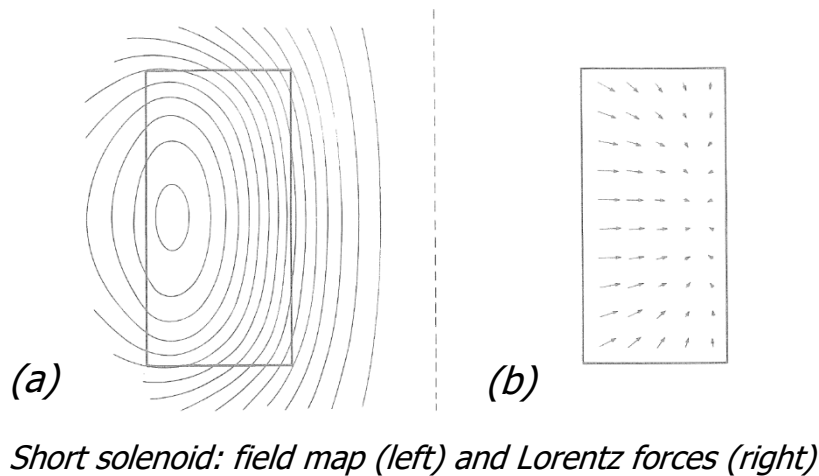

Thin coil:
Rout/Rin=1.3

Thick coil:
Rout/Rin=4

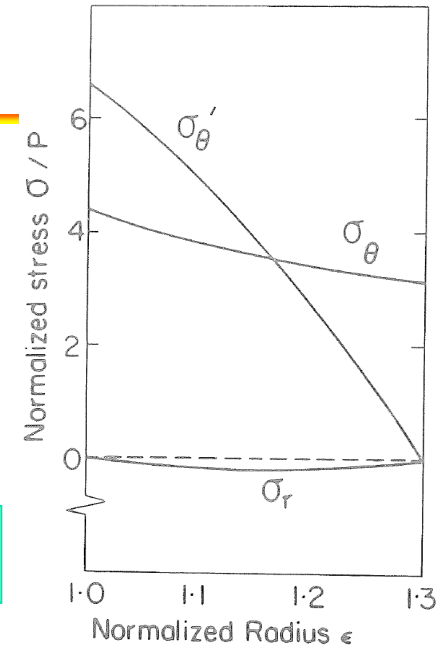

- The Lorentz forces in a solenoid tend to push the coil:
 - Outwards in the radial-direction ($F_r > 0$)
 - Towards the mid plane in the axial direction ($F_y < 0$)
- Radial stresses are not neglected (label σ_{θ}).
- When radial stresses become tensile (positive), there is a risk of resin cracking, which may induce a quench.
- In summary, long and thin solenoids are mechanically more stable.

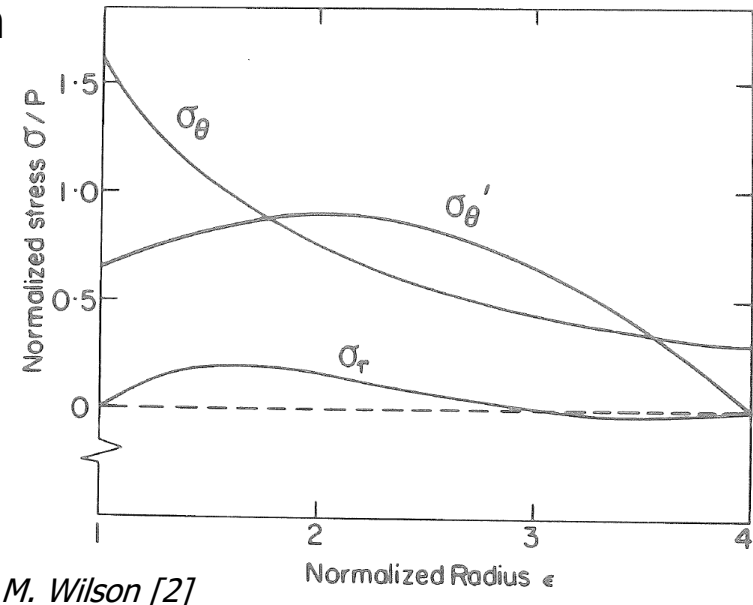

M. Wilson [2]

AMS solenoid: real case (I)

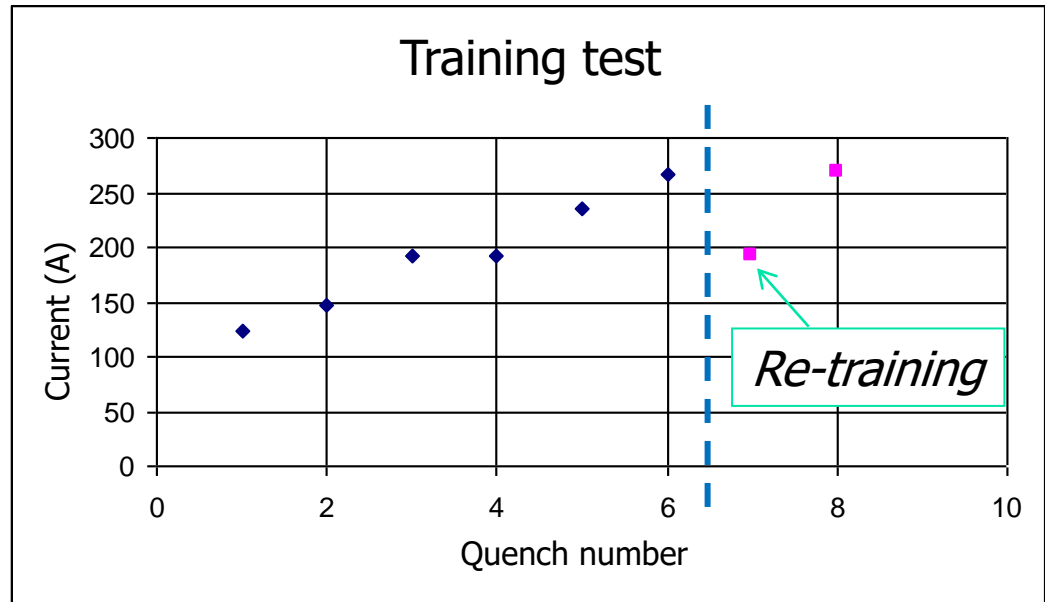
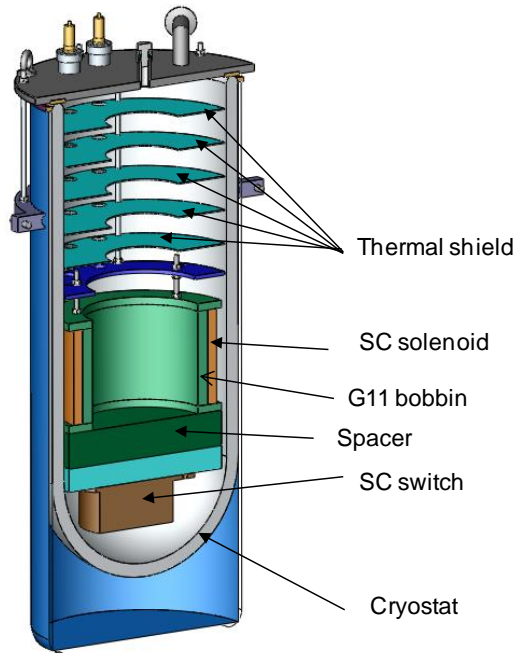

Length	123.75 mm
Inner diameter	188.72 mm
Outer diameter	215 mm
Number of turns	1782
Nominal current	450 A
Peak field	5.89 T
Bore field	4.25 T
Current density	493 A·mm ⁻²
Working point	75%
Self inductance	0.5 H

- A short solenoid was trained with poor results, below 50% on the load line: a mechanical design mistake limits the performance.

S. Sanz et al., "Development of a superconducting solenoid to test AMS power supply", CIEMAT, 2006

AMS solenoid: real case (II)

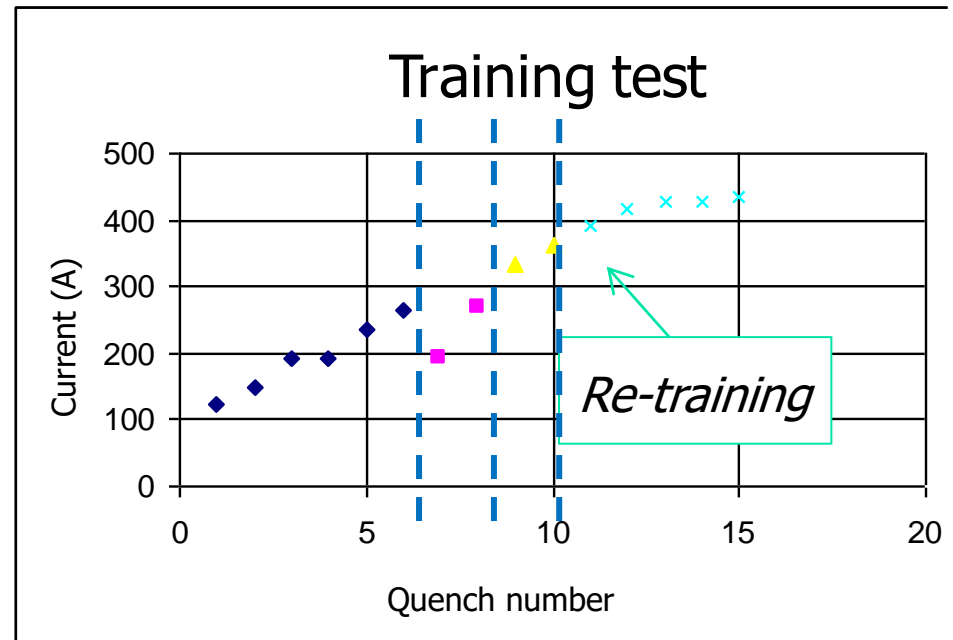
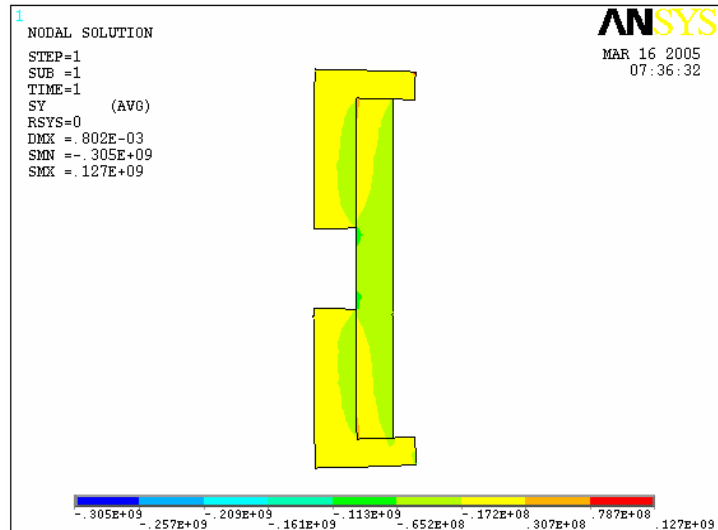
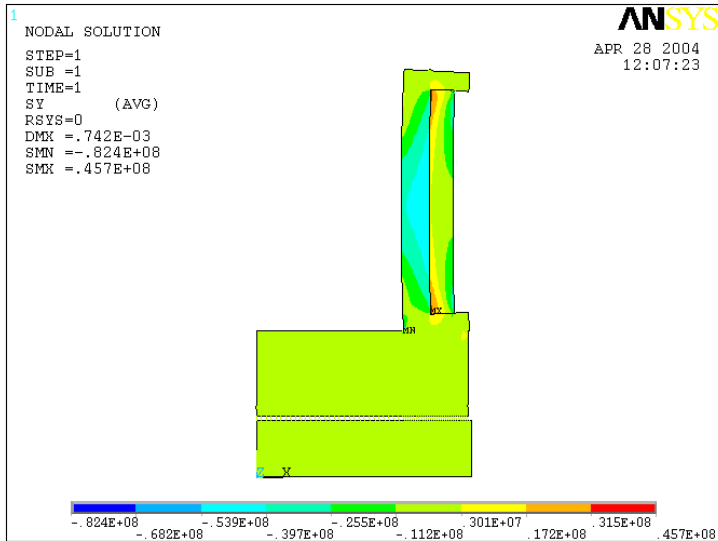

- Post-mortem analysis: the thermal contraction of G10 bobbin is smaller than that of the winding.
- The bobbin core was split in two: the axial stress distribution is now completely different, no tensile stress on the winding.

IFMIF/EVEDA solenoid: lessons learnt

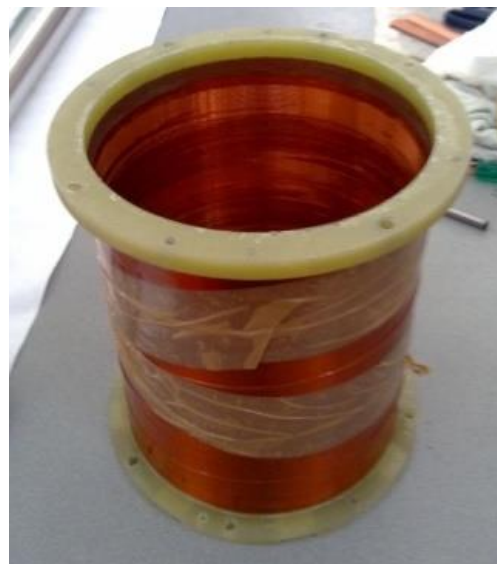
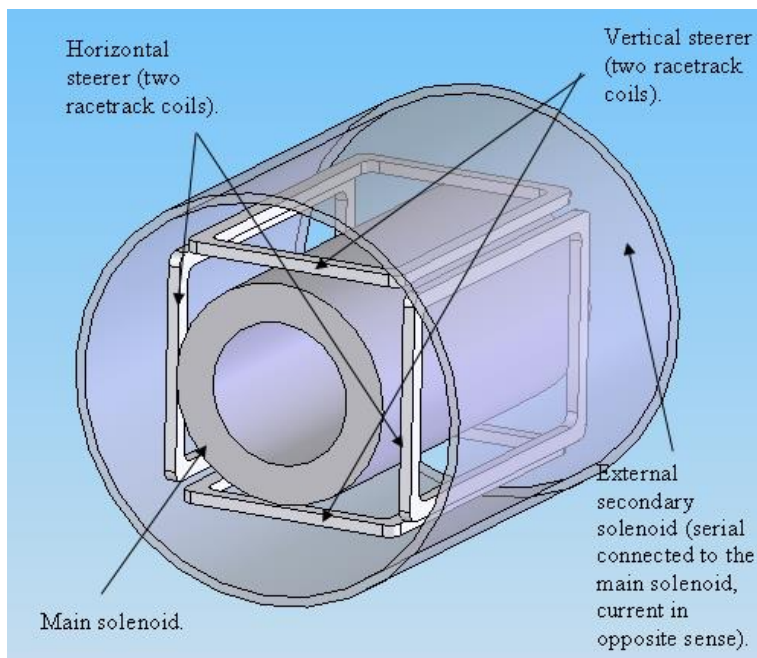

Outer SC solenoid

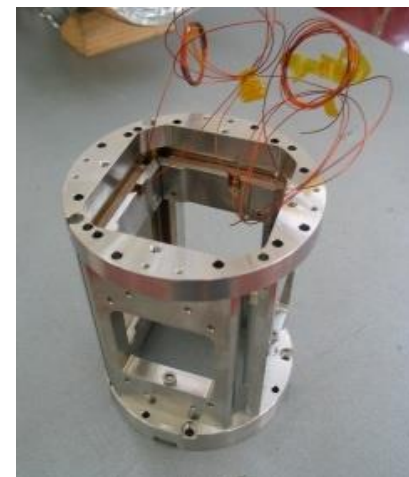

Steerer coils in support structure

- Two **concentric solenoids** powered in opposite senses.
- No need of **external support** because they are thin and long.
- No **bobbin** to avoid differential thermal contractions and increase superconductor efficiency.
- Complex structure to hold the **corrector coils**.
- Only 1 quench below critical current in 8 powering tests!

S. Sanz et al. "Fabrication and testing of the first magnet package prototype for the SRF Linac of LIPAC", IPAC 2011

What have we learnt by now?

- The mechanical design of a superconducting magnet aims to **avoid tensile stresses** in the coil and mechanical degradation of materials.
- Electromagnetic (Lorentz) force is a **body force**.
- We have reviewed basic **concepts** of strength of materials, such as stress, strain, modulus of elasticity, failure criteria...
- **Material properties** are strongly dependent on temperature. Coils are a composite of insulating materials and superconductors.
- Magnetic pressure induces **hoop stresses** in the solenoid conductors.
- **Long and thin solenoids** are mechanically more stable than thick and short ones.
- **Differential** thermal coefficients may induce premature quenches in superconducting magnets.

Numerical methods (a bit of philosophy)

- **Analytical** expressions are generally valid only for simplified models.
- **Numerical** methods are able to model a magnet very **accurately**:
 - Anisotropic material properties.
 - Complicated geometry.
 - “Sophisticated” boundary conditions: sliding/contact surfaces, joints.
 - Load steps: assembly, cooling down, energizing.
 - Transient problems.
- **Personal opinion**: there is a common mistake... to forget about analytical approach and come directly to the numerical simulation. Analytical methods are **NECESSARY**:
 - To understand the problem.
 - To make a first estimate of the solution.
 - To simplify the numerical simulation.
 - To check and UNDERSTAND the results of the numerical simulation.

Numerical methods (more philosophy)

- The most used one is the **Finite Element Method**.
- **Commercial** software: ANSYS, COMSOL, CAST3M
- Take your time to think of the most adequate **model**: do not include all the features in the first simulation:
 - Is a 2-D model enough for my needs?
 - Do I need to include friction?
 - Should I model all the screw holes?
 - Which are the boundary conditions?
 - Where do I need a fine mesh?
- **Material properties** must be so realistic as possible: *rubbish in, rubbish out*.
- Analyze carefully the **results**. Is what you expect?
- Do not make a **parametric** analysis if it is not necessary: better to understand how your mechanical system works.

Outline

- Motivation
- Basic concepts
- Solenoids
- Accelerator magnets:
 - Coil dominated field:
 - Winding approximations: thin shell, thick shell, sector.
 - End forces.
 - Support structures: low, high and very high field magnets.
 - Iron dominated field.
- Toroids
- Final example
- Measurement techniques

Accelerator superconducting magnet types

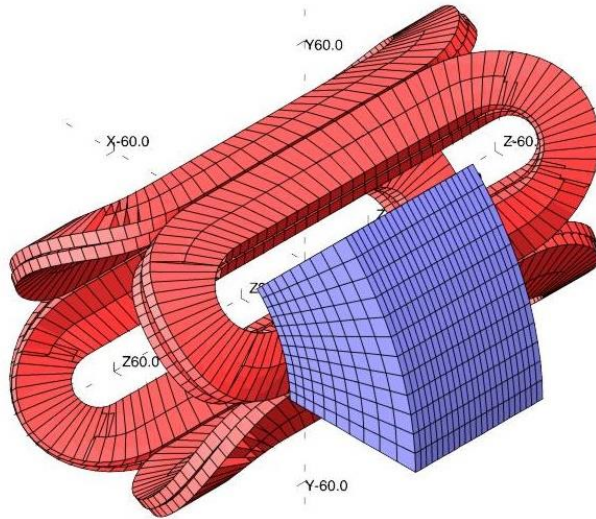

Coil dominated field

- Field quality dominated by the coils (iron is optional).
- High fields (>3 T).
- Usually complicated coil geometries: cos-theta, canted cos-theta (CCT), block, common-coil.

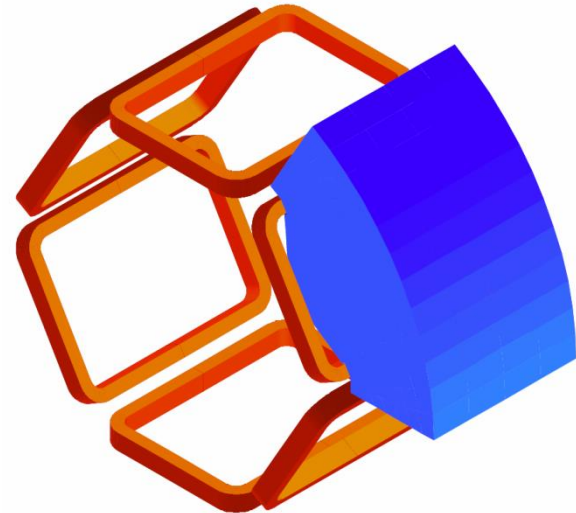

Iron dominated field

- Field quality dominated by the iron yoke.
- Moderate field (2-3 T).
- Flat coils.

Cos- θ type magnets: Lorentz forces (I)

- The Lorentz forces in a n-pole magnet tend to push the coil:
 - Towards the mid plane in the vertical-azimuthal direction ($F_y, F_\theta < 0$)
 - Outwards in the radial-horizontal direction ($F_x, F_r > 0$)

Tevatron dipole

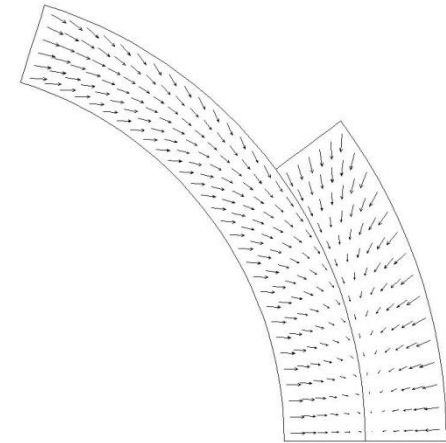
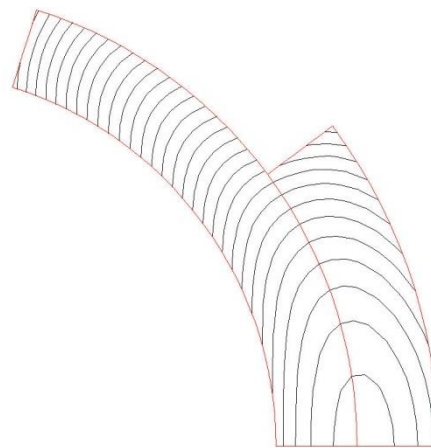
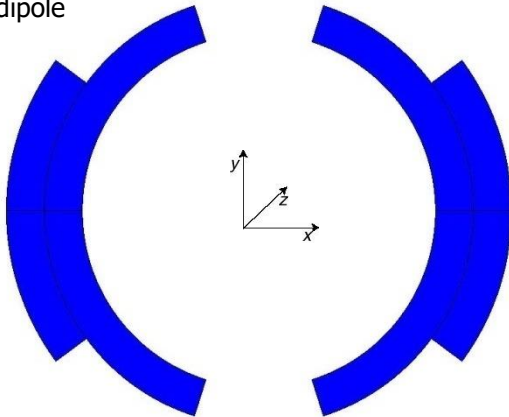

TQ

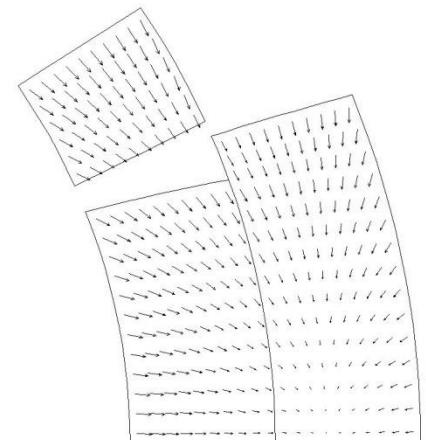
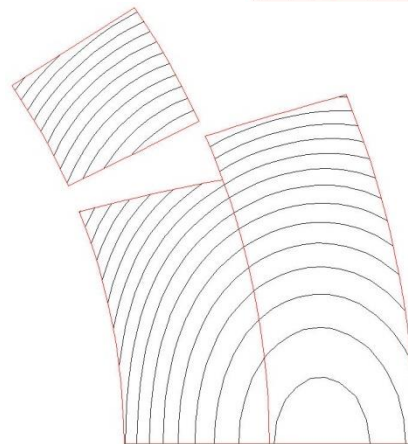
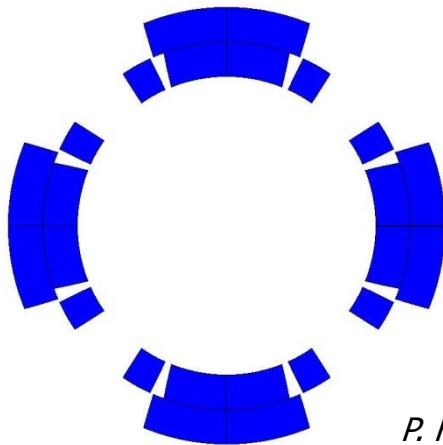

P. Ferracin [5]

Cos- θ type magnets: Lorentz forces (II)

- In the coil ends, the Lorentz forces tend to make the coil **longer**: outwards in the longitudinal direction ($F_z > 0$).
- In short, the field lines try to expand the coil, like in a current loop.
- However, the coil is unable to support the magnetic forces in tension. These forces must be hold by an external support structure.

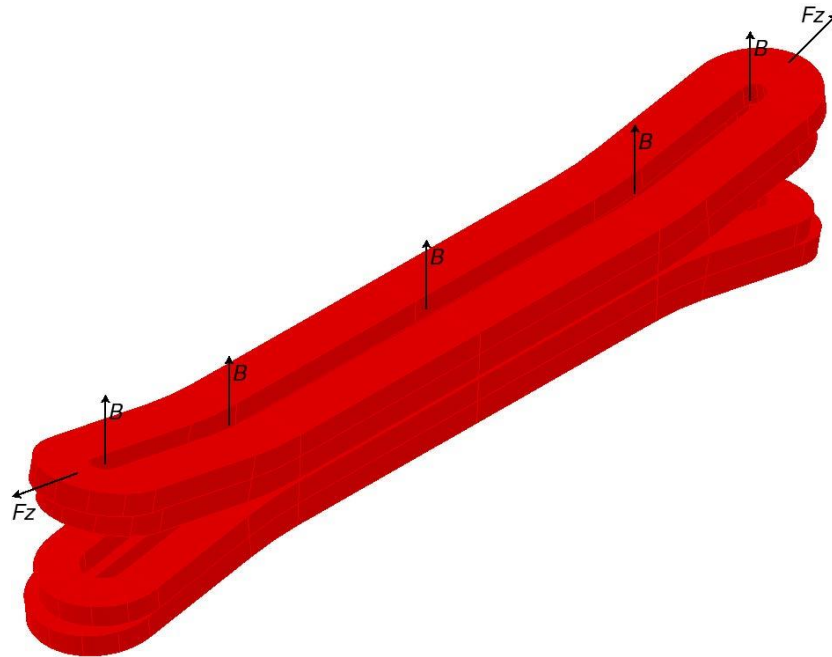

Approximations of $\cos\theta$ winding cross-sections

- In order to estimate the force, let's consider three different approximations for a n-order magnet:
 - Thin shell (see Appendix I)
 - Current density $J = J_0 \cos n\theta$ (A per unit circumference) on a infinitely thin shell
 - Orders of magnitude and proportionalities
 - Thick shell (see Appendix II)
 - Current density $J = J_0 \cos n\theta$ (A per unit area) on a shell with a finite thickness
 - First order estimate of forces and stress
 - Sector (see Appendix III)
 - Current density $J = \text{constant}$ (A per unit area) on a sector with a maximum angle $\theta = 60^\circ/30^\circ$ for a dipole/quadrupole
 - First order estimate of forces and stress

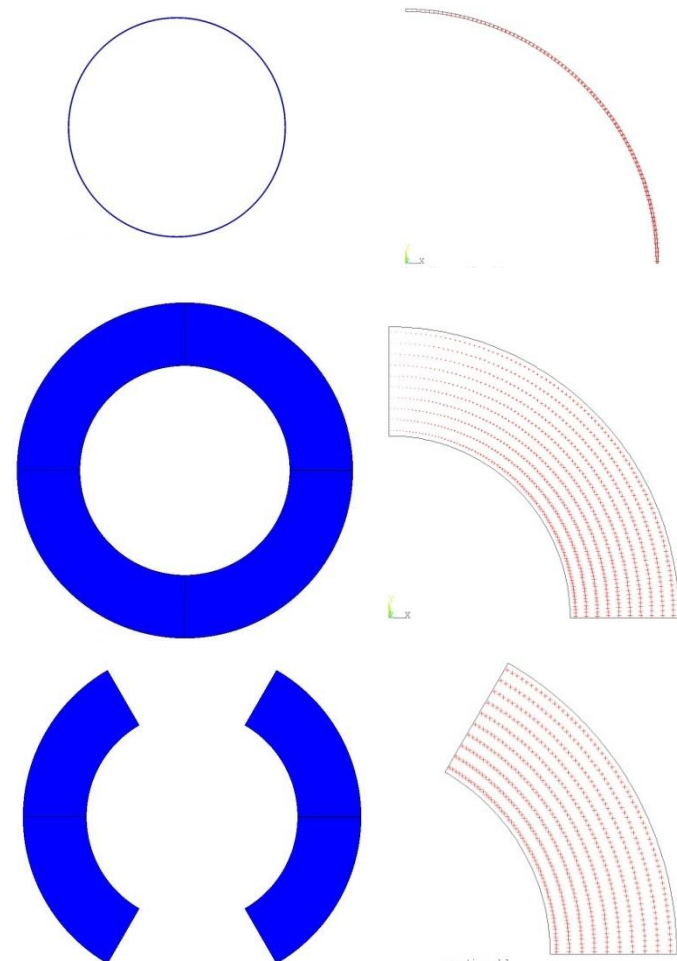

P. Ferracin [5]

Thin shell (current sheet) (I)

- **Beth's theorem:** the complex force on a current element (per unit length in the longitudinal direction z) is equal to the line integral of magnetic pressure around the boundary of that element in the complex plane:

$$\vec{F} = F_y + iF_x = -\oint \frac{B^2}{2\mu_0} dz$$

- For a cylindrical current sheet, the total force [N/m] on half a coil is:

$$\vec{F} = \frac{1}{2\mu_0} \int_0^{\pi/2n} (B_{in}^2 - B_{out}^2) i a e^{i\theta} d\theta$$

- If current density is given by $J = J_0 \cos n\theta$ [A/m], and assuming iron with $\mu = \infty$ at radius R , the density force f [N/m²] is:

$$\vec{f} = f_x + i f_y = \frac{\mu_0 J_0^2}{8} \left\{ \left[1 + 2 \left(\frac{a}{R} \right)^{2n} \right] e^{-i\theta(2n-1)} - e^{i\theta(2n+1)} + 2 \left(\frac{a}{R} \right)^{2n} e^{i\theta} \right\}$$

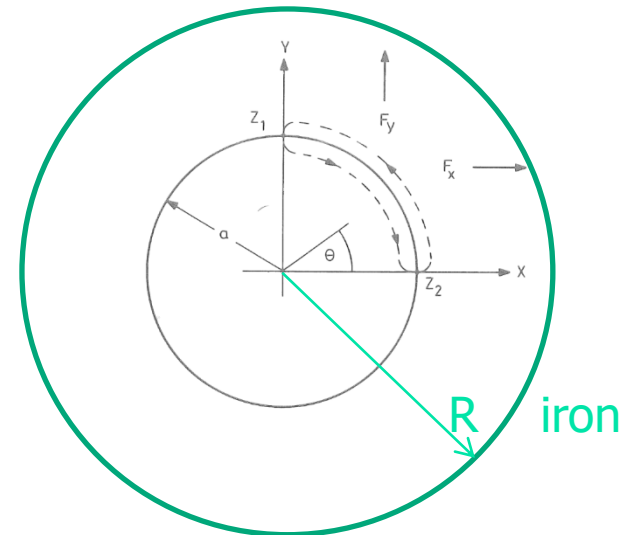

Thin shell (current sheet) (II)

- One can get the tangential and normal components by dot product with the tangent and normal unit vectors:

$$f_r = \vec{f} \cdot \vec{n} = \vec{f} \cdot e^{i\theta} = \frac{\mu_0 J_0^2}{4} \left(\frac{a}{R}\right)^{2n} [1 + \cos(2n\theta)]$$

$$f_\theta = \vec{f} \cdot \vec{t} = \vec{f} \cdot e^{i(\pi/2+\theta)} = -\frac{\mu_0 J_0^2}{4} \left[1 + \left(\frac{a}{R}\right)^{2n}\right] \sin(2n\theta)$$

- For a dipole, the force on half the coil is:

$$F_x [N/m] = \int_0^{\pi/2} (f_r \cos \theta - f_\theta \sin \theta) a d\theta = \frac{\mu_0 J_0^2}{2} \left[\frac{1}{3} + \left(\frac{a}{R}\right)^2 \right] a$$

$$F_y [N/m] = \int_0^{\pi/2} (f_r \sin \theta + f_\theta \cos \theta) a d\theta = -\frac{\mu_0 J_0^2}{2} \frac{1}{3} a$$

- It is proportional to the square of the current density (and field) and the bore radius.
- See Appendix for expressions on dipole and quadrupole without iron.

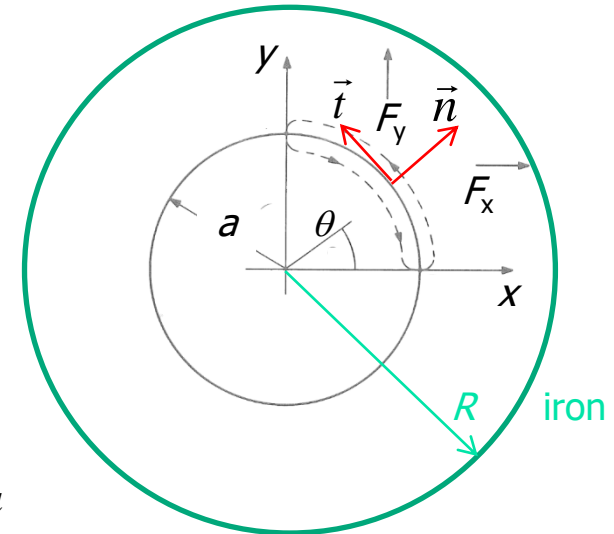

Thin shell (current sheet) (III)

- One can consider a real winding like a sum of current sheets and solve the problem by superposition.
- It works fine for the field, the stored magnetic energy and the forces.
 - Application to a corrector quadrupole prototype magnet developed for LHC, MQTL.

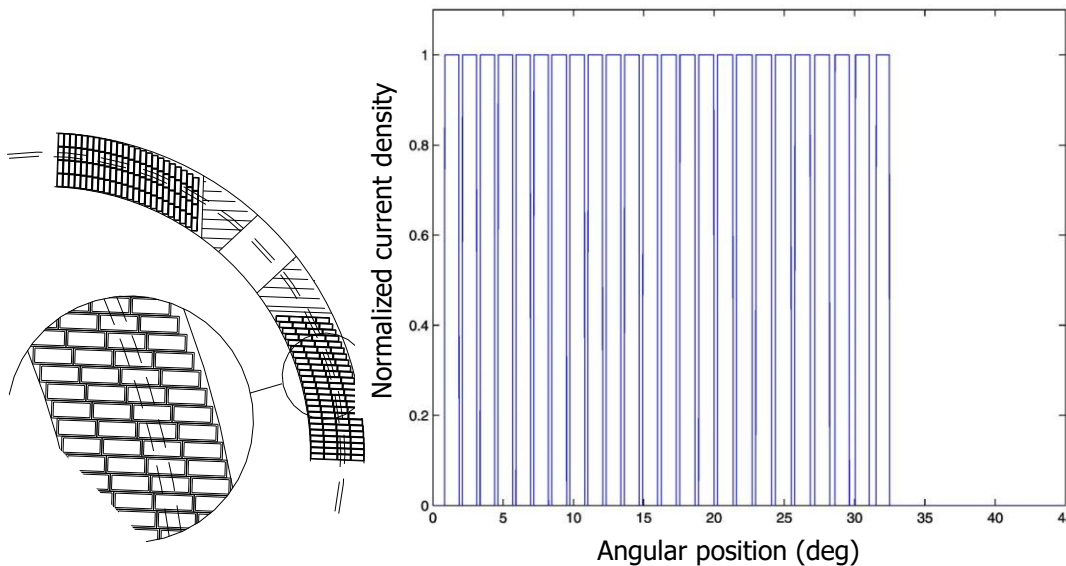

e	SHEET	ROXIE	FEM	Units
	2.99	3.00	2.99	T/m
	98.4854	98.4616	98.1640	units
	1.1899	1.1871	1.4283	units
	0.0152	0.0152	0.2352	units
	0.366	0.368	0.379	T
	0.0547	0.0546	0.0548	mH/m
	51.74	50.30	48.955	N
	-118.26	-116.57	-115.27	N

F. Toral et al., "Further Developments on Beth's Current-Sheet Theorem: Computation of Magnetic Field, Energy and Mechanical Stresses in the Cross-Section of Particle Accelerator Magnets", MT-18, 2004

Thick shell (I)

- We assume
 - $J = J_0 \cos n\theta$ where J_0 [A/m²] is \perp to the cross-section plane
 - Inner (outer) radius of the coils = a_1 (a_2)
 - No iron
- The field inside the aperture is

$$B_{ri} = -\frac{\mu_0 J_0}{2} r^{n-1} \left(\frac{a_2^{2-n} - a_1^{2-n}}{2-n} \right) \sin n\vartheta \quad B_{\theta i} = -\frac{\mu_0 J_0}{2} r^{n-1} \left(\frac{a_2^{2-n} - a_1^{2-n}}{2-n} \right) \cos n\vartheta$$

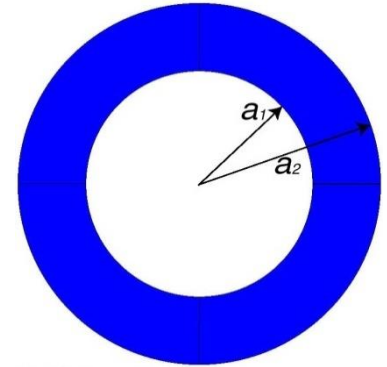

- The field in the coil is

$$B_r = -\frac{\mu_0 J_0}{2} \left[r^{n-1} \left(\frac{a_2^{2-n} - r^{2-n}}{2-n} \right) + \frac{1}{2+n} \left(\frac{r^{2+n} - a_1^{2+n}}{r^{1+n}} \right) \right] \sin n\vartheta \quad B_\theta = -\frac{\mu_0 J_0}{2} \left[r^{n-1} \left(\frac{a_2^{2-n} - r^{2-n}}{2-n} \right) - \frac{1}{2+n} \left(\frac{r^{2+n} - a_1^{2+n}}{r^{1+n}} \right) \right] \cos n\vartheta$$

- The Lorentz force acting on the coil [N/m³] is

$$f_r = -B_\theta J = \frac{\mu_0 J_0^2}{2} \left[r^{n-1} \left(\frac{a_2^{2-n} - r^{2-n}}{2-n} \right) - \frac{1}{2+n} \left(\frac{r^{2+n} - a_1^{2+n}}{r^{1+n}} \right) \right] \cos^2 n\vartheta \quad f_x = f_r \cos \theta - f_\theta \sin \theta$$

$$f_\theta = B_r J = -\frac{\mu_0 J_0^2}{2} \left[r^{n-1} \left(\frac{a_2^{2-n} - r^{2-n}}{2-n} \right) + \frac{1}{2+n} \left(\frac{r^{2+n} - a_1^{2+n}}{r^{1+n}} \right) \right] \sin n\theta \cos n\vartheta \quad f_y = f_r \sin \theta + f_\theta \cos \theta$$

R. Meuser [4]

Thick shell (II)

- In a dipole, the field inside the coil is:

$$B_y = -\frac{\mu_0 J_0}{2} (a_2 - a_1)$$

- The total force acting on the coil [N/m] is:

$$F_x = \frac{\mu_0 J_0^2}{2} \left[\frac{7}{54} a_2^3 + \frac{1}{9} \left(\ln \frac{a_2}{a_1} + \frac{10}{3} \right) a_1^3 - \frac{1}{2} a_2 a_1^2 \right]$$

$$F_y = -\frac{\mu_0 J_0^2}{2} \left[\frac{2}{27} a_2^3 + \frac{2}{9} \left(\ln \frac{a_1}{a_2} - \frac{1}{3} \right) a_1^3 \right]$$

- A simple approximation of the maximum stress at the midplane is:

$$\sigma_y [MPa] = \frac{F_y}{b - a}$$

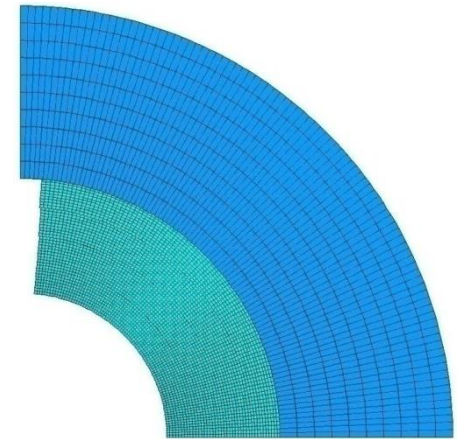

Sector: dipole (I)

- We assume
 - Uniform $J=J_0$ is \perp the cross-section plane
 - Inner (outer) radius of the coils = a_1 (a_2)
 - Angle $\phi = 60^\circ$ (third harmonic term is null)
 - No iron
- The field inside the aperture

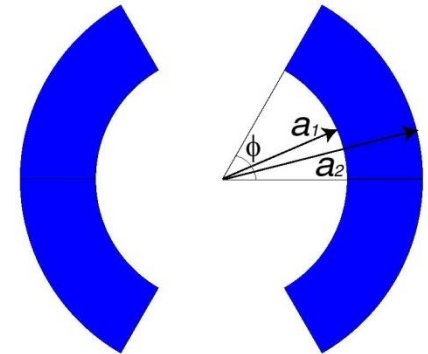

$$B_r = -\frac{2\mu_0 J_0}{\pi} \left[(a_2 - a_1) \sin \phi \sin \theta + \sum_{n=1}^{\infty} \frac{r^{2n}}{(2n+1)(2n-1)} \left(\frac{1}{a_1^{n-1}} - \frac{1}{a_2^{n-1}} \right) \sin(2n+1)\phi \sin(2n+1)\theta \right]$$

$$B_\theta = -\frac{2\mu_0 J_0}{\pi} \left[(a_2 - a_1) \sin \phi \cos \theta + \sum_{n=1}^{\infty} \frac{r^{2n}}{(2n+1)(2n-1)} \left(\frac{1}{a_1^{n-1}} - \frac{1}{a_2^{n-1}} \right) \sin(2n+1)\phi \cos(2n+1)\theta \right]$$

- The field in the coil is

$$B_r = -\frac{2\mu_0 J_0}{\pi} \left\{ (a_2 - r) \sin \phi \sin \theta + \sum_{n=1}^{\infty} \left[1 - \left(\frac{a_1}{r} \right)^{2n+1} \right] \frac{r}{(2n+1)(2n-1)} \sin(2n-1)\phi \sin(2n-1)\theta \right\}$$

$$B_\theta = -\frac{2\mu_0 J_0}{\pi} \left\{ (a_2 - r) \sin \phi \cos \theta - \sum_{n=1}^{\infty} \left[1 - \left(\frac{a_1}{r} \right)^{2n+1} \right] \frac{r}{(2n+1)(2n-1)} \sin(2n-1)\phi \cos(2n-1)\theta \right\}$$

R. Meuser [4]

Sector: dipole (II)

- The Lorentz force acting on the coil [N/m³], considering the basic term, is

$$f_r = -B_\theta J = + \frac{2\mu_0 J_0^2}{\pi} \sin \phi \left[(a_2 - r) - \frac{r^3 - a_1^3}{3r^2} \right] \cos \theta \quad f_x = f_r \cos \theta - f_\theta \sin \theta$$

$$f_\theta = B_r J = - \frac{2\mu_0 J_0^2}{\pi} \sin \phi \left[(a_2 - r) + \frac{r^3 - a_1^3}{3r^2} \right] \sin \theta \quad f_y = f_r \sin \theta + f_\theta \cos \theta$$

- The total force acting on the coil [N/m] is

$$F_x = + \frac{2\mu_0 J_0^2}{\pi} \frac{\sqrt{3}}{2} \left[\frac{2\pi - \sqrt{3}}{36} a_2^3 + \frac{\sqrt{3}}{12} \ln \frac{a_2}{a_1} a_1^3 + \frac{4\pi + \sqrt{3}}{36} a_1^3 - \frac{\pi}{6} a_2 a_1^2 \right]$$

$$F_y = - \frac{2\mu_0 J_0^2}{\pi} \frac{\sqrt{3}}{2} \left[\frac{1}{12} a_2^3 + \frac{1}{4} \ln \frac{a_1}{a_2} a_1^3 - \frac{1}{12} a_1^3 \right]$$

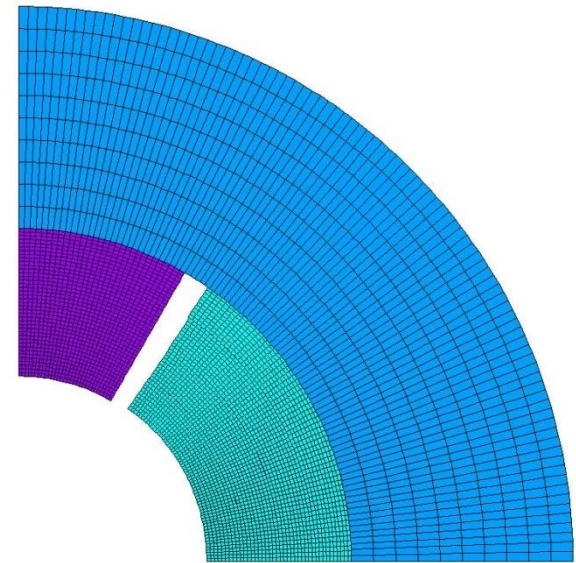

Sector: dipole (III)

- Stress due to the accumulation of forces in the midplane for a sector coil of angle a on the bore radius
 - B : bore field (T)
 - j : overall current density (A/m²)
 - r : aperture radius (m)
 - σ will be in Pa

$$S_{qq}(r,0) = (\cos a - 1) Bjr$$

- For a 60° sector coil $\cos(60^\circ)=1/2$

$$S_{qq}(r,0) = -\frac{1}{2} Bjr$$

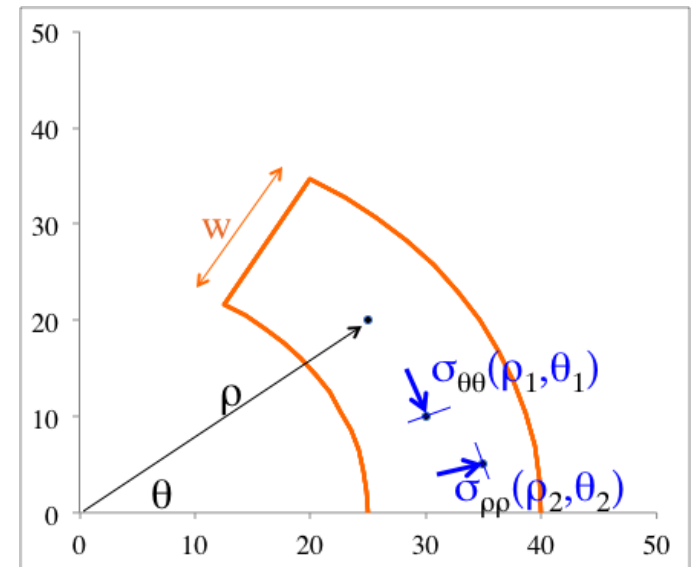

Courtesy E. Todesco

End forces

- **Virtual displacement principle:** the variation of stored magnetic energy U with the magnet length equals the axial force pulling from the ends, keeping constant the other dimensions.

$$F_z [N] = \frac{\partial U}{\partial z}$$

- That is, the stored magnetic energy per unit length equals the axial force: in LHC main dipole, it is 125 kN per coil end.
- In the case of a thin shell, it can be written as:

$$F_z [N] = \frac{\mu_0 \pi}{4n} \left[1 + \left(\frac{a}{R} \right)^{2n} \right] J_0^2 a^2$$

- For the same current density, the end forces on a quadrupole coil are half than in a dipole.
- Please find expressions for thick shell and sector approximations in the Appendices. Calculations are made writing the stored energy U as a function of the magnetic vector potential A , obtained from the field:

$$B_r(r, \theta) = \frac{1}{r} \frac{\partial A_z}{\partial \theta} \quad B_\theta(r, \theta) = -\frac{\partial A_z}{\partial r}$$

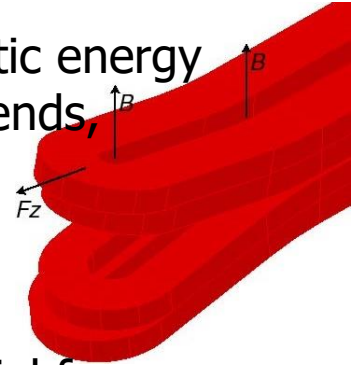

End forces: other useful approximation

- **Magnetic pressure** or energy density of magnetic field

$$p_m = \sigma_B = \frac{B^2}{2\mu_0}$$

- Note that this is a pressure (N/m²)
- Indeed, it is also an energy density (N.m/m³) = J/m³

- **Stored energy** in a magnet

$$U = \int_V \frac{\frac{1}{2} B(x, y, z)^2}{2m_0} dx dy dz$$

- Can be approximated by
- B : bore field
- r : aperture radius
- w : coil width
- l_m : magnet length

$$U \gg \frac{B^2}{2m_0} \rho (r + w)^2 l_m$$

Courtesy E. Todesco

- **Forces** in magnet heads

$$F = \frac{U}{l_m} \gg \frac{B^2}{2m_0} \rho (r + w)^2$$

What have we learnt by now?

- There are two main **types** of superconducting accelerator magnets: coil and iron dominated field magnets.
- In **cos- θ magnets**, the winding cross-section may be approximated in different ways: thin shell, thick shell or sectors.
- **Axial forces** on coil ends equal the stored magnetic energy per unit length.

Outline

- Motivation
- Basic concepts
- Solenoids
- Accelerator magnets:
 - Coil dominated field:
 - Winding approximations: thin shell, thick shell, sector.
 - End forces.
 - Support structures: low, high and very high field magnets.
 - Iron dominated field.
- Toroids
- Final example
- Measurement techniques

Support structures (I)

- One of the main concerns of the mechanical designer is to avoid tensile stresses in the superconducting conductors when they are powered.
- The classical solution is to apply a **pre-compression**: arch bridge.

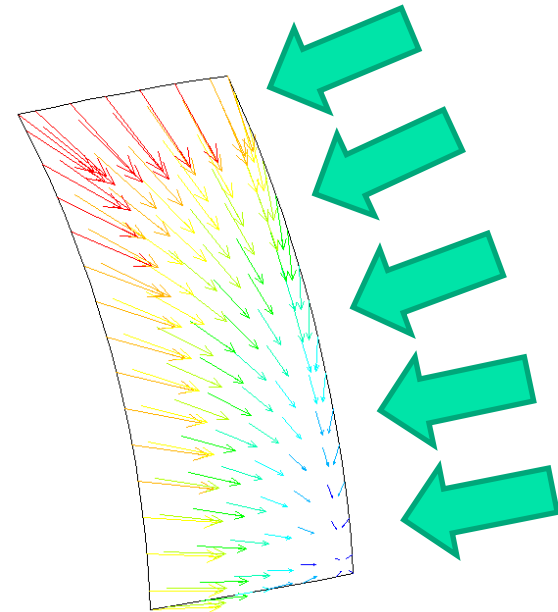

- For $\cos\theta$ winding configurations, the external structure usually applies a radial inward compression which is transformed into azimuthal compression inside the coil which counteracts the formation of tensile stresses that would otherwise appear under the action of the electromagnetic forces.

Support structures (II)

- The outer shell must be stiff enough.
- A simple approach is to assume the radial Lorentz force as a uniform pressure or take the horizontal component:

$$\sigma_{\theta} [MPa] = \frac{F [N/m]}{\delta} = \frac{P \cdot a}{\delta} \qquad \sigma_{\theta} [MPa] = \frac{F_{Lx}}{\delta}$$

- The maximum stress in the shell at cool-down is usually about 200-300 MPa.
- For n-pole magnets, one can compute the maximum bending moment in a thin cylinder under radial forces separated by an angle of 2θ :

$$M = \frac{Fa}{2} \left(\frac{\cos(x)}{\sin(\theta)} - \frac{1-\alpha}{\theta} \right)$$

$$\alpha = \frac{\delta^2}{12a^2}$$

$$\sigma_{\theta} = \frac{6M}{\delta^2}$$

Roark's formulas for stress and strain, McGraw-Hill

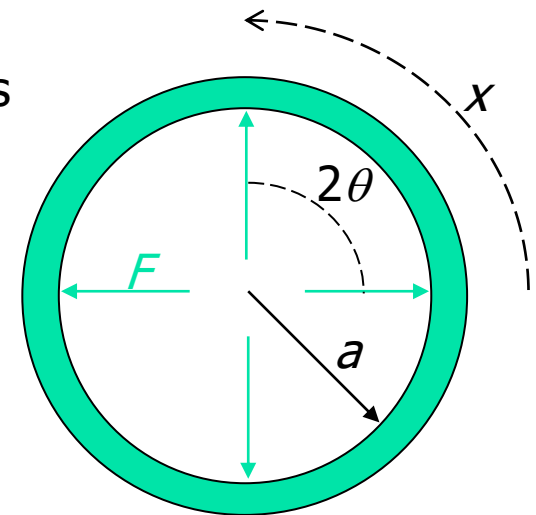
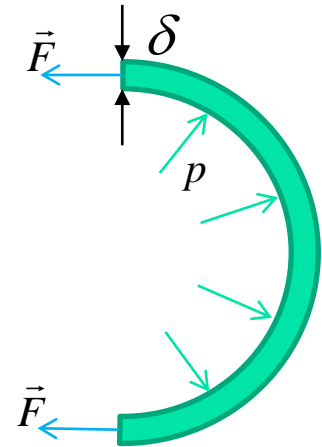

Low field magnets: LHC correctors

- Let's assume as low field magnets those with peak field **below 4 T**. Conductors are usually **monolithic** wires (fully impregnated coils).
- The coils of most of LHC corrector magnets were pre-compressed by **scissors iron laminations**:
 - The pre-compression is provided by an outer aluminum shrinking cylinder.
 - The iron cannot be a hollow cylinder because it contracts less than the coils.
 - Using eccentric paired laminations with different orientations, the inwards pressure is made alternatively on neighbour coils.
- The iron is placed very close to the coils for field enhancement.
- It is a simple system for series production: fine blanking.

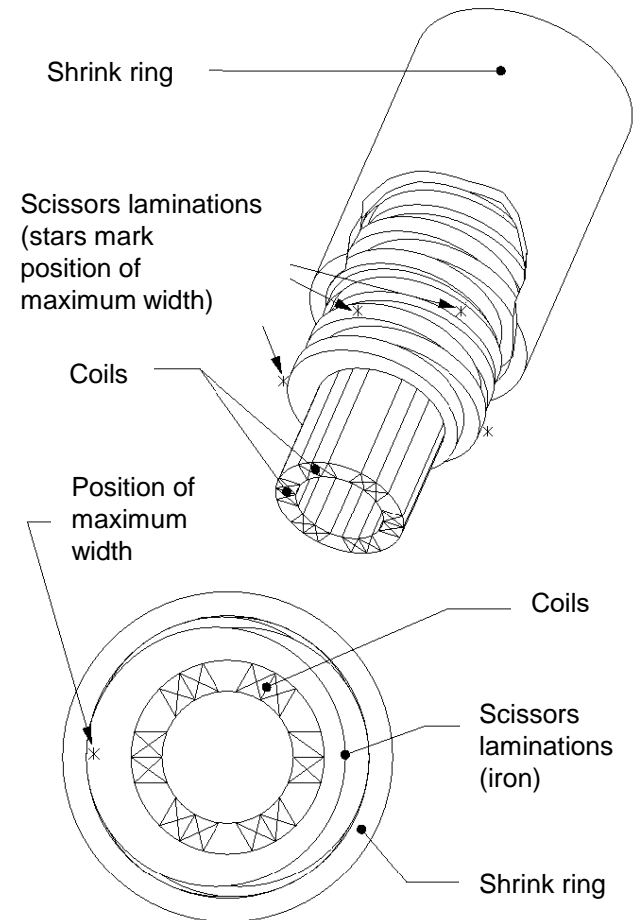

A. Ijspeert, J. Salminen, "Superconducting coil compression by scissor laminations", LHC Report 47, 1996

Low field magnets: MQTL

- Lessons that can be extracted from one of the quadrupole LHC corrector prototypes, MQTL, which was 1.2 m long:
 - Holes in the iron to improve the field quality are elliptic to decrease the stress accumulation at the hole inner edge.
 - Slow training test, with no improvement from 4 to 1.9 K: mechanical problem.
 - It is not solved with increased interference (ModA). Detraining suggests “slip-stick” movements between the iron laminations and the coils due to axial forces.

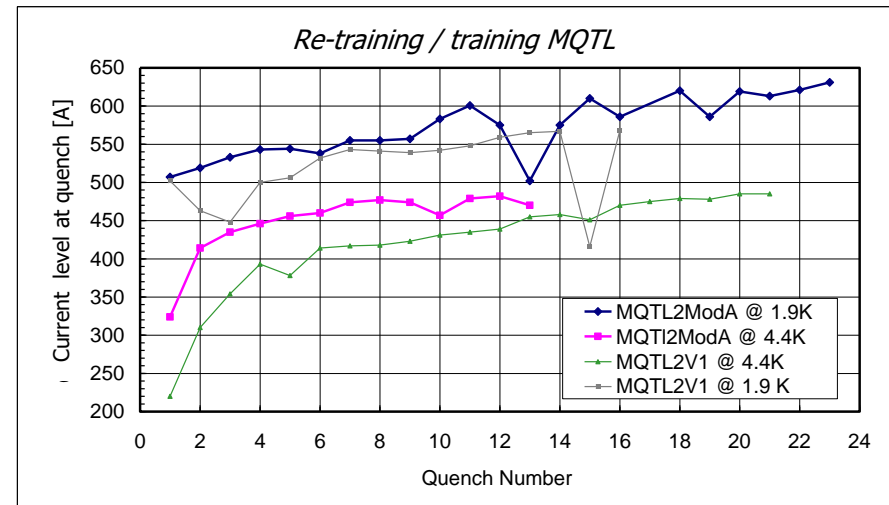
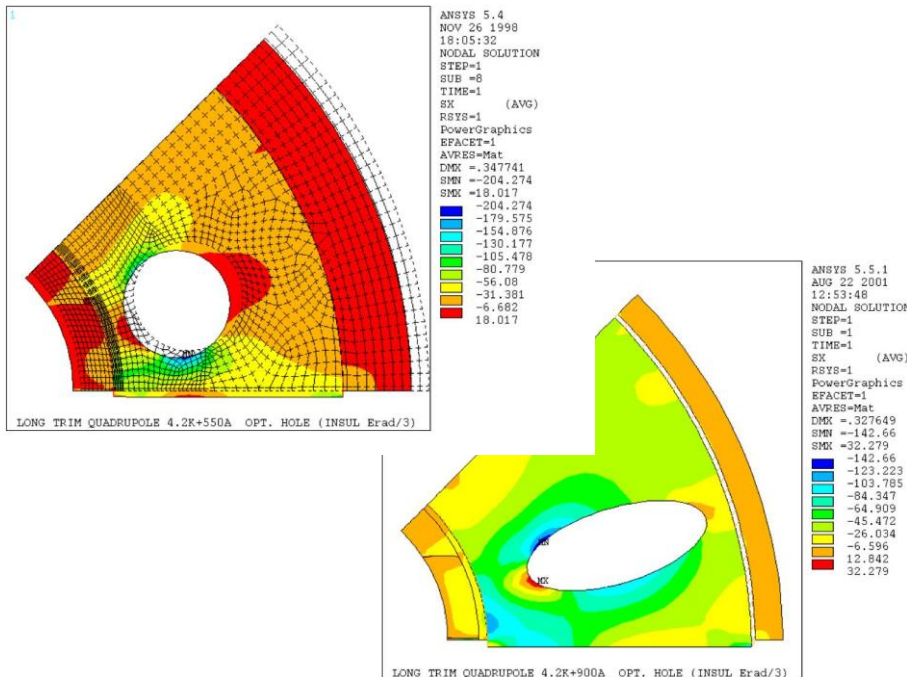

F. Toral, PhD Thesis, Madrid, 2001

Low field magnets: TESLA500 quadrupole (I)

- If the coils of a quadrupole prototype for TESLA500/ILC project were energized without any support structure, they would experience tensile (positive) stresses. Nominal current is 100 A, at 50% on the load line.

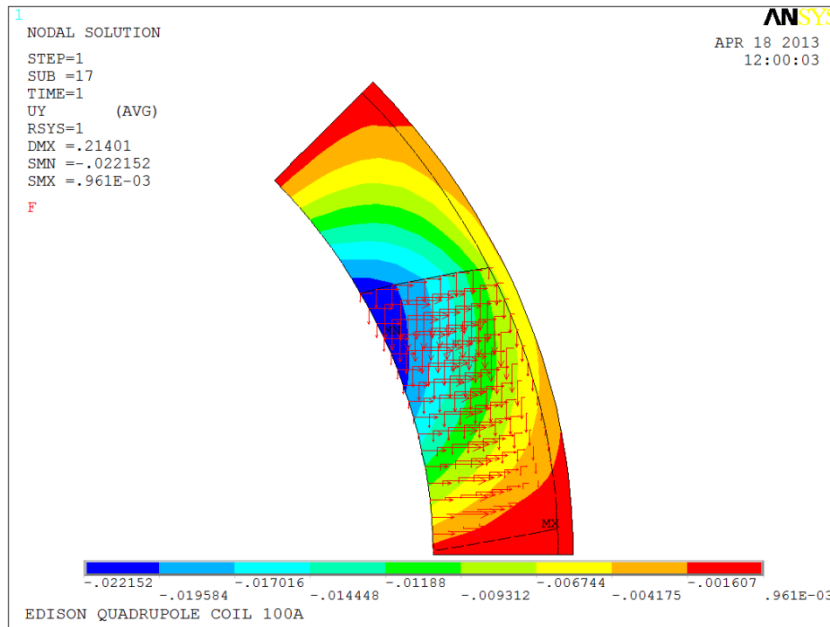

Deformations (mm) in azimuthal direction

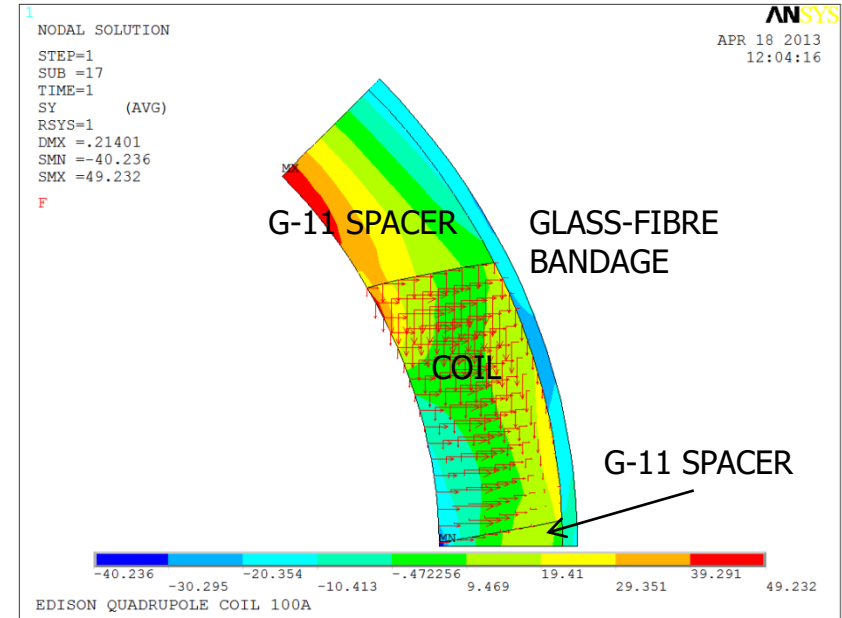

Stresses (MPa) in azimuthal direction

F. Toral et al., "Fabrication and Testing of a Combined Superconducting Magnet for the TESLA Test Facility", MT-19, 2005

Low field magnets: TESLA500 quadrupole (II)

- The coil assembly was protected by a wrapped glass-fiber bandage. The pre-compression was provided by an outer aluminum cylinder.
- The iron was split in four sectors. Each sector had radii which fitted with the coils and the shrinking cylinder at cold conditions.

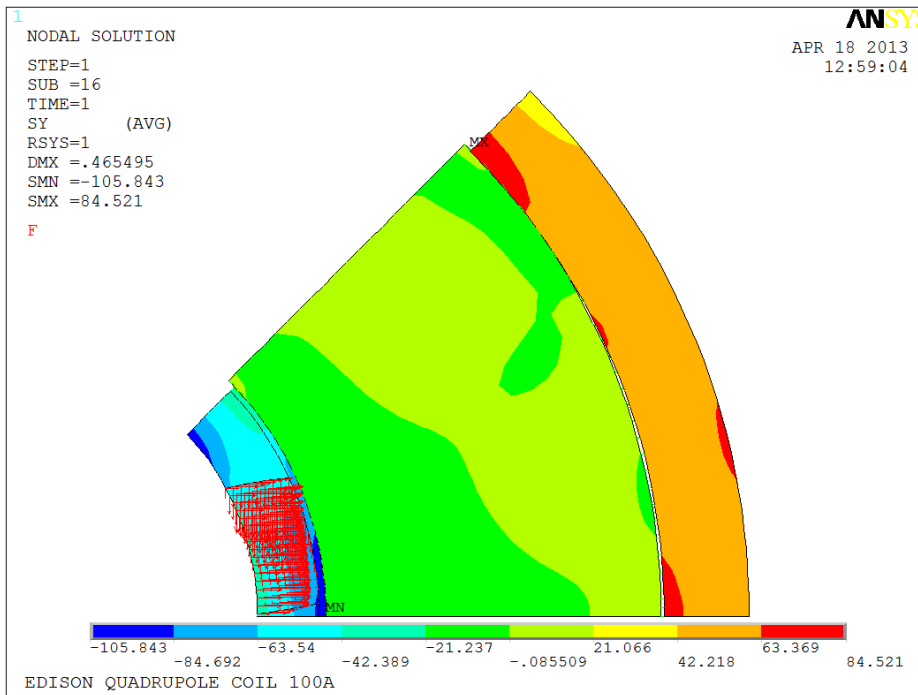
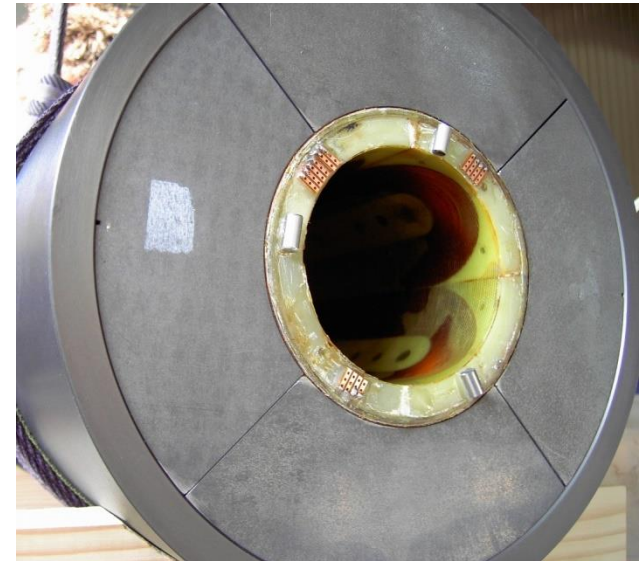

Deformations (mm) in azimuthal direction

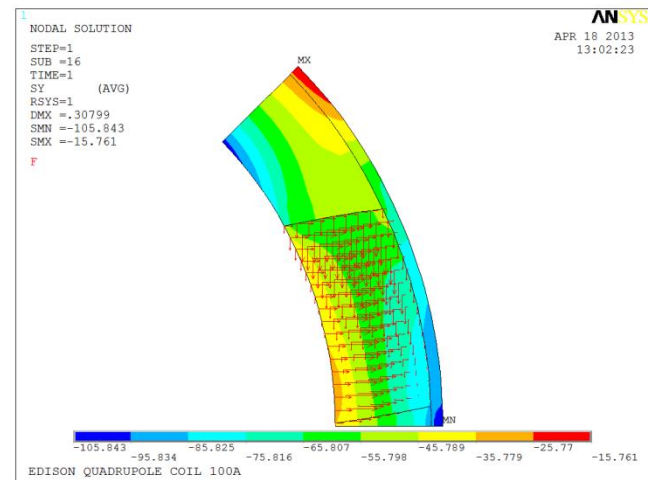

Stresses (MPa) in azimuthal direction

Low field magnets: TESLA500 quadrupole (III)

- The first training test was quite poor.
- Two of the iron sectors were shimmed to balance the pre-compression: second training improved a lot.
- Training did not improve cooling down to 1.9K: a mechanical problem limits performance, likely the end forces or the nested dipole coils.

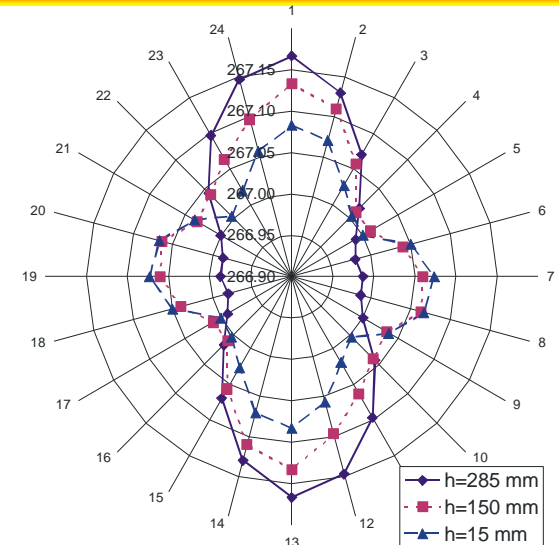
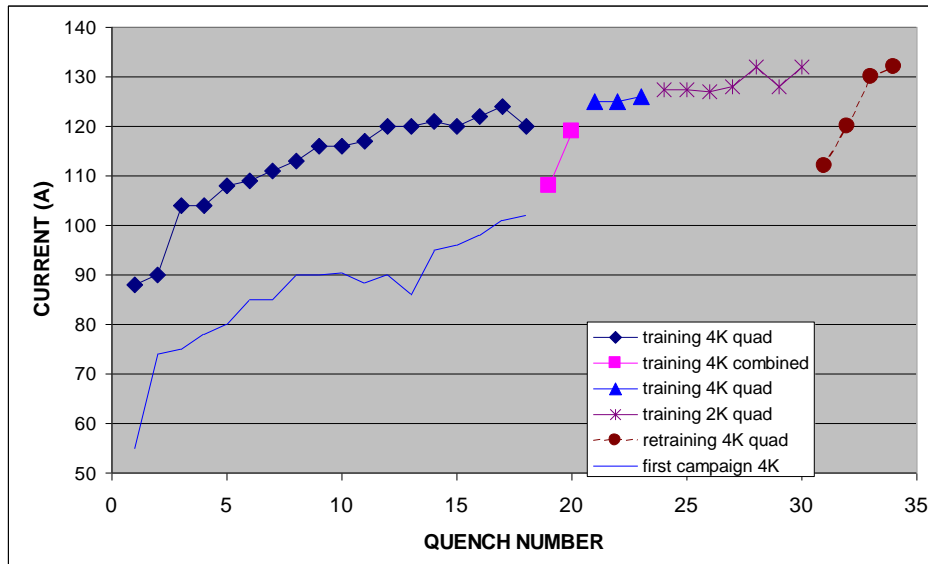

Aluminum outer diameter before re-assembly

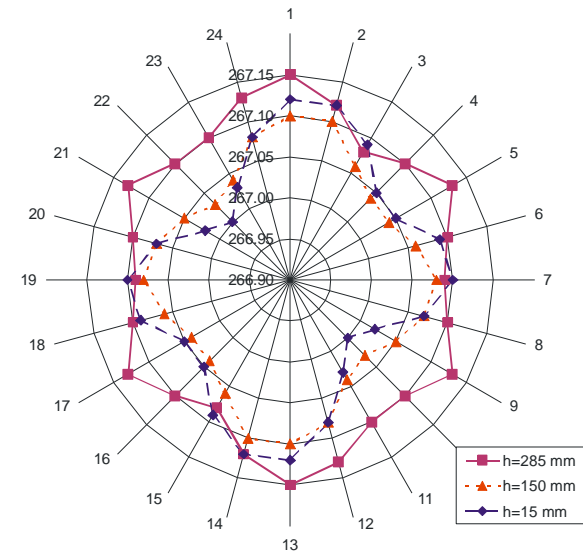

Aluminum outer diameter after re-assembly

Outline

- Motivation
- Basic concepts
- Solenoids
- Accelerator magnets:
 - Coil dominated field:
 - Winding approximations: thin shell, thick shell, sector.
 - End forces.
 - Support structures: low, high and very high field magnets.
 - Iron dominated field.
- Toroids
- Final example
- Measurement techniques

Support structures: high field magnets

- Let's consider as high field magnets those with coil peak fields in the range from 4 to 10 T. Conductors are usually cables with polyimide tape insulation.
- In the case of the Tevatron main dipole ($B_{nom} = 4.4$ T), assuming an infinitely rigid structure without pre-stress, the pole would move off about $-100 \mu\text{m}$, with a stress on the mid-plane of -45 MPa at nominal current.

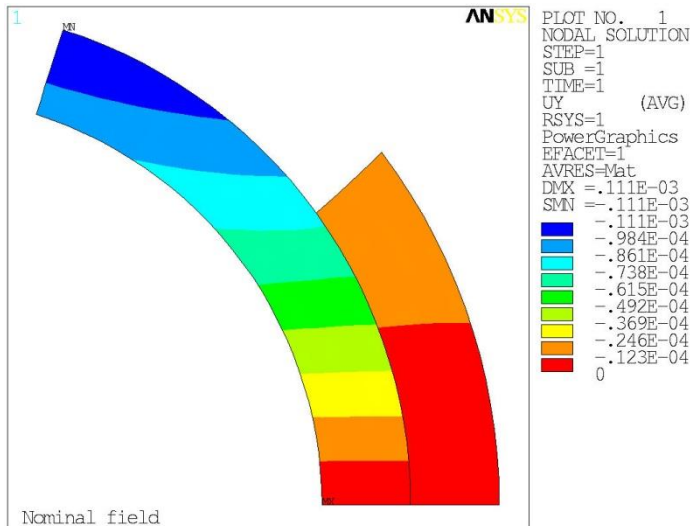
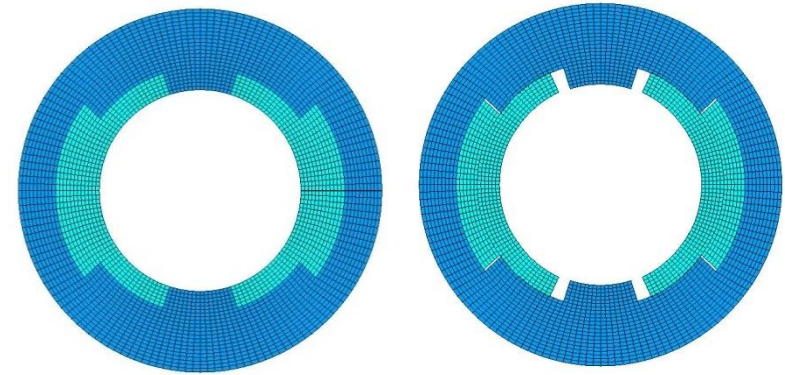

Azimuthal displacements

P. Ferracin [5]

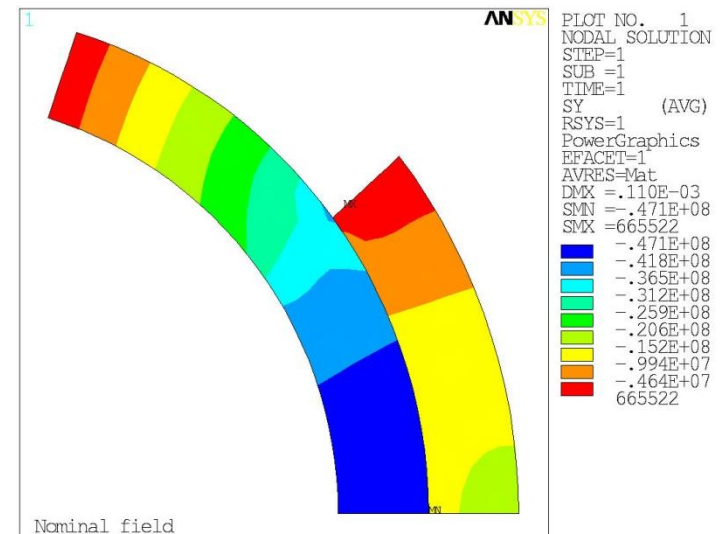

Azimuthal stress distribution

Support structures: pole turn

- We focus now on the stress and displacement of the pole turn (high field region) in different pre-stress conditions.
- The total displacement of the pole turn is proportional to the pre-stress.
 - A full pre-stress condition (-33 MPa) minimizes the displacements.

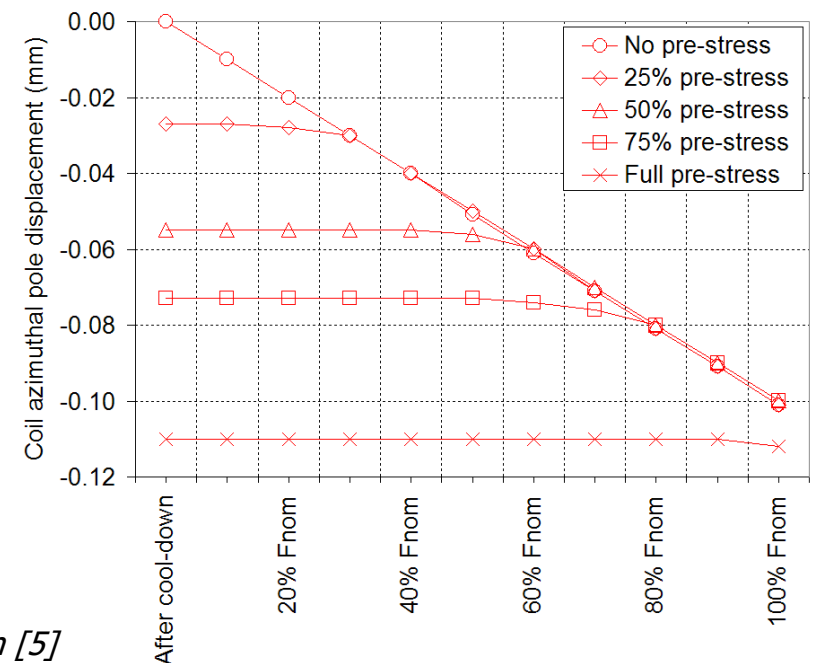
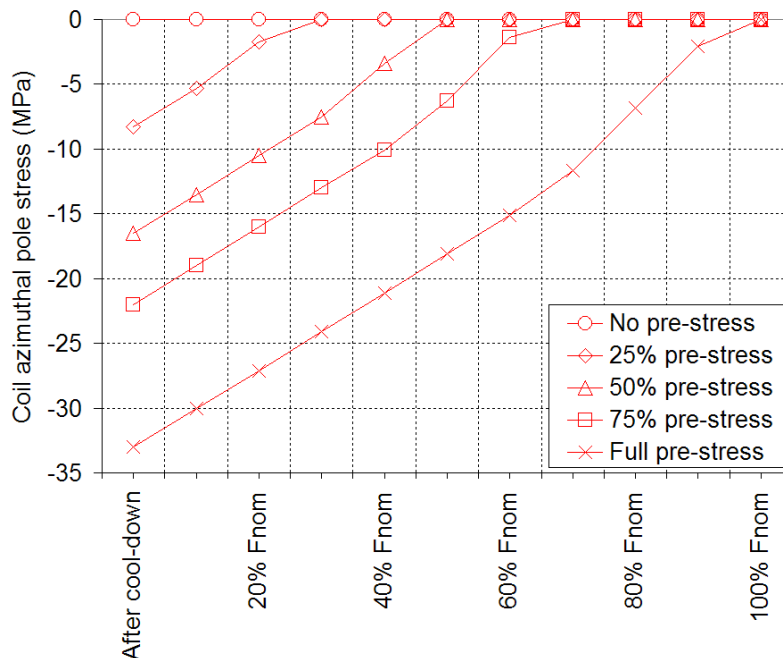
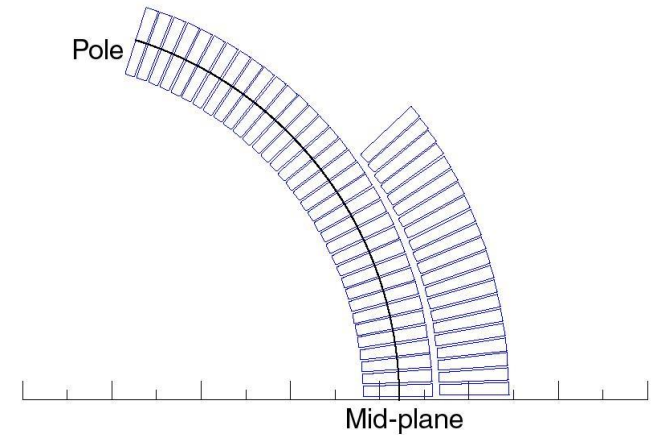

P. Ferracin [5]

Support structures: pre-load

- The practice of pre-stressing the coil has been applied to all the accelerator large dipole magnets:
 - Tevatron (K. Koepke, et al., IEEE Trans. Magn., Vol. MAG-15, No. 1, Jan. 1979)
 - HERA (S. Wolff, AIP Conf. Proc. 249, 1992, pp. 1160-1197)
 - SSC (A. Devred, AIP Conf. Proc. 249, 1992, pp. 1309-1372 and T. Ogitsu, et al., IEEE Trans. Appl. Supercond., Vol. 3, No. 1, March 1993, pp. 686-691)
 - RHIC (J. Muratore, BNL, private communications)
 - LHC (CERN-2004-003-v-1, 2004)
- The pre-stress is chosen in such a way that the coil remains in contact with the pole at nominal field, sometime with a “mechanical margin” of more than 20 MPa.

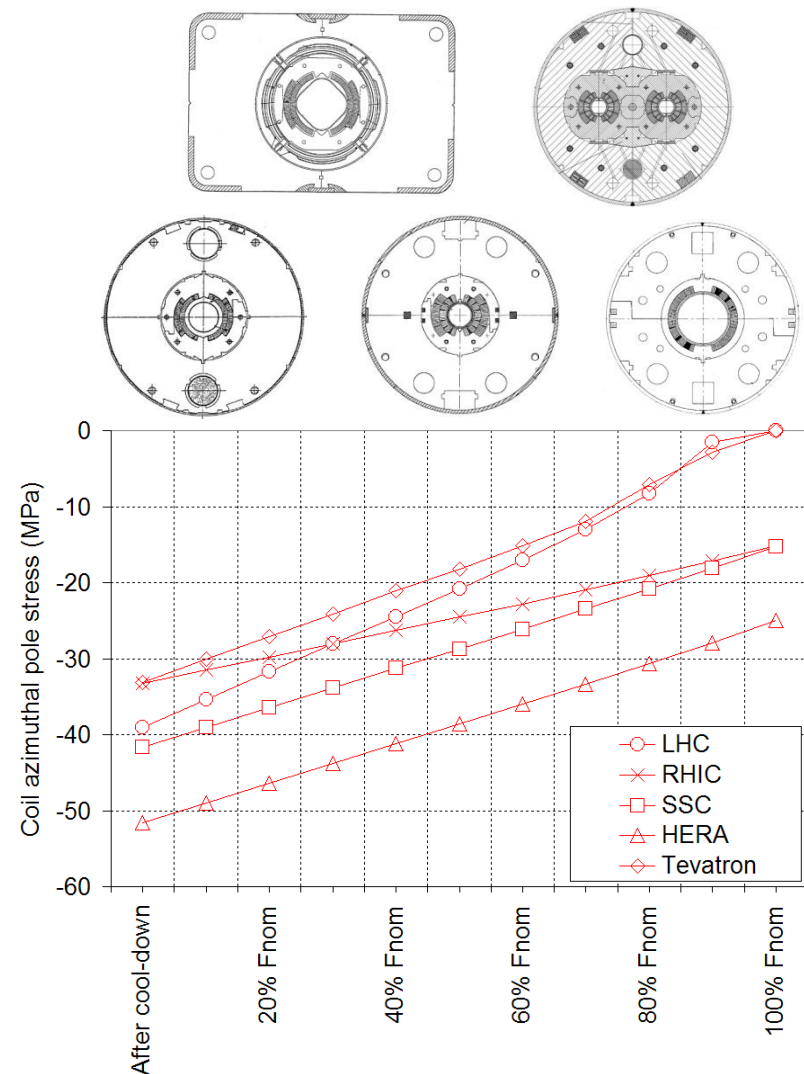

Support structures: collars

- **Collars** were implemented for the first time in the Tevatron dipoles.
- Since then, they have been used in all but one (RHIC) the high field $\cos\theta$ accelerator magnets and in most of the R&D magnets.
- They are composed by stainless-steel or aluminum laminations few mm thick.
- The collars take care of the Lorentz forces and provide a high accuracy for coil positioning. Its shape tolerance is about ± 20 micron.
- A good knowledge of the coil properties (initial dimensions and E) is mandatory to predict final coil status.
- In addition, collar deformation must be taken into account.

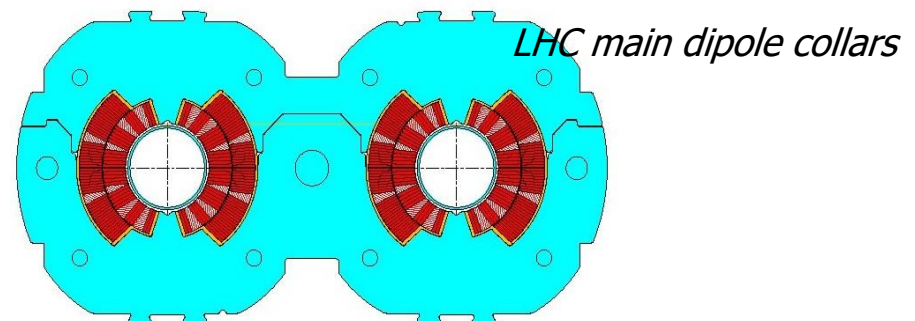
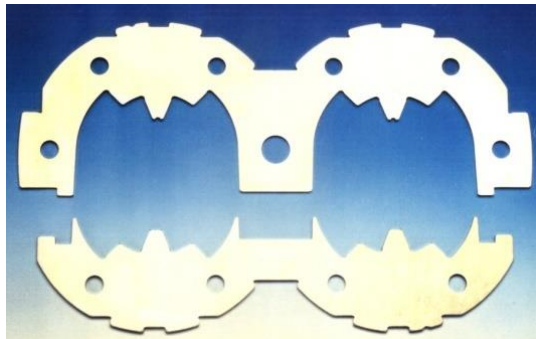

L. Rossi, "Superconducting Magnets", CERN Academic Training, 15-18 May 2000.

Support structures: collared coil assembly

- Since the uncompressed coil is oversized with respect to the collar cavity dimension, at the beginning of the collaring procedure the collars are not locked (open).
- The coil/collar pack is then introduced into a collaring press.
- The pressure of the press is increased until a nominal value.
- Collars are locked with keys, rods or welded, then the press is released.
- Once the collaring press is released, the collar experience a “spring back” due to the clearance of the locking feature and deformation.
- The pre-stress may change during cool-down due to the different thermal contraction of the collars and coils.

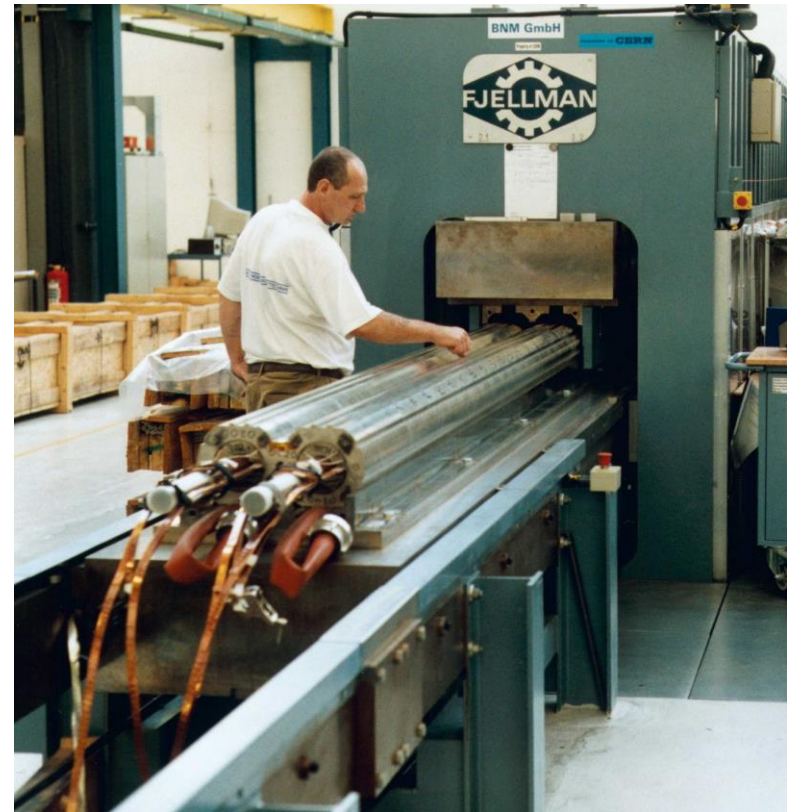

LHC dipole collaring

L. Rossi, "The LHC from construction to commissioning", FNAL seminar, 19 April 2007.

Collars: calculations

- Hard to find analytical approximations for collar design.
- The force supported by the structure depends also on the azimuthal Lorentz force.
- Thin sheet and sector coil approximations are used!

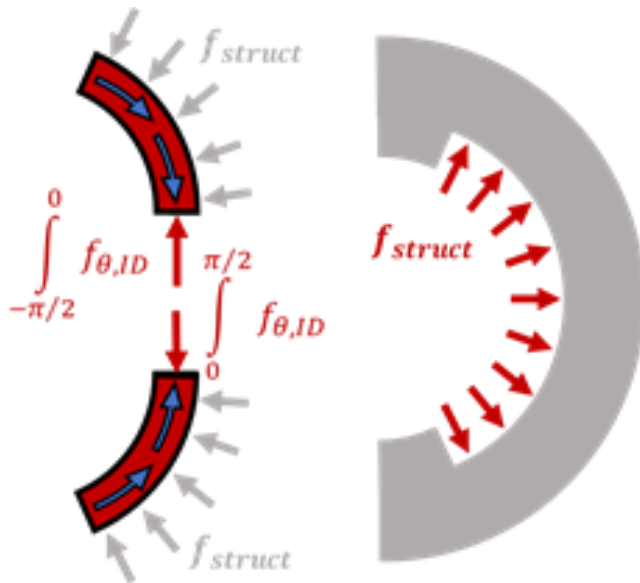

$$f_{struct} = f_r + \int_{\theta_0}^{\theta} f_{\theta} d\theta$$

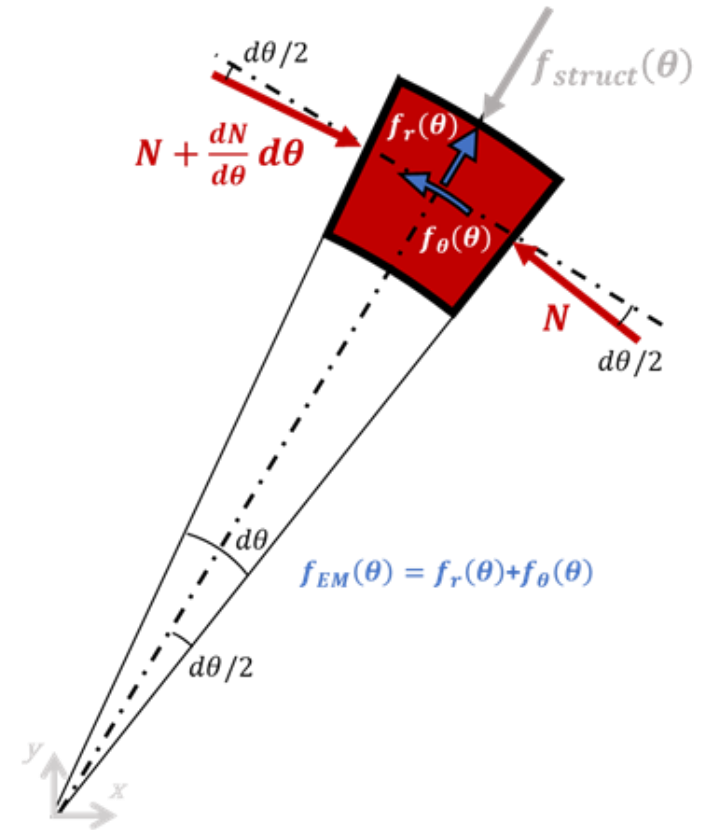

J. García-Matos, PhD Thesis, 2022

High field magnets: support from iron

- For fields above 6T, it is usually necessary that **the rest of the structure contributes to support the Lorentz forces**.
- In that case, the collars can be thin and the iron is placed closer to the coils (enhancing the field at the aperture)
- This approach is implemented in **D1 HL-LHC magnet** (or RHIC dipole many years ago).
- The disadvantage is that you need more parts produced with high accuracy.

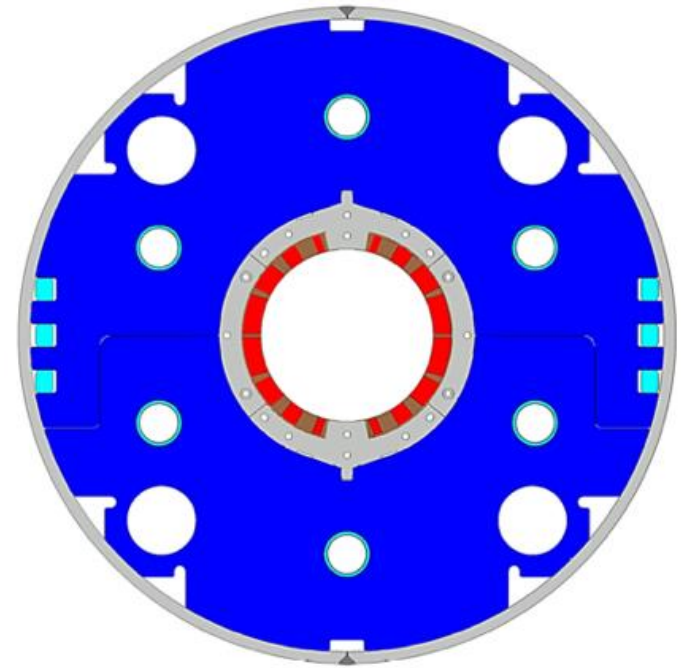

T. Nakamoto, T. Sugano et al.

High field magnets: axial support

- Two common solutions:
 - **Stoppers** welded to the shell: LHC, SSC, 11 Tesla dipole.
 - **Rods** and nuts: MQXF, MCBXF.
- **Preload** can be applied by means of grub screws. Typically, it is about one half of the electromagnetic force. The aim is to avoid quenches due to sudden axial movements: friction, thermal contraction??
- **Iron** is usually laminated. Packing factor comes into play at the same time.
- The outer **shell** can act as liquid helium container.
- Be careful with **long magnets**: Poisson effect cannot be neglected.



TQ quadrupole (P. Ferracin)

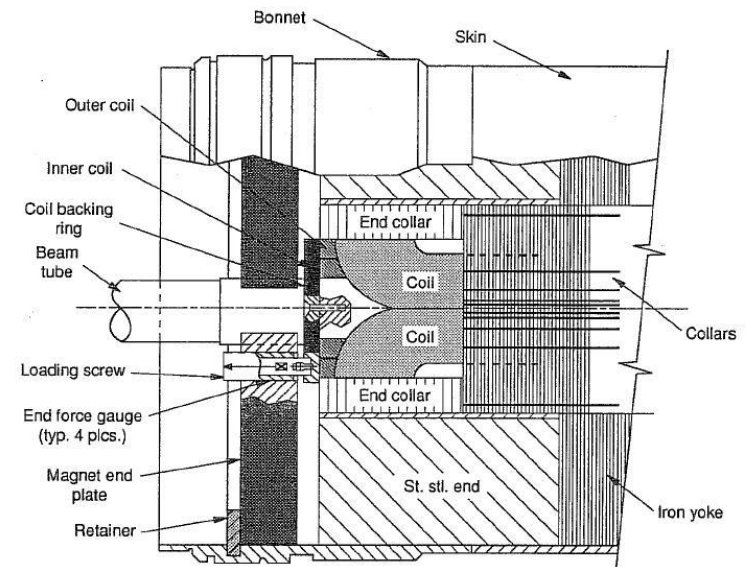

SSC dipole (A. Devred)

Application case: MCBXF nested corrector

- Two nested dipoles.
- Impregnated NbTi coils.
- Mechanical clamping of torque: high radiation dose.

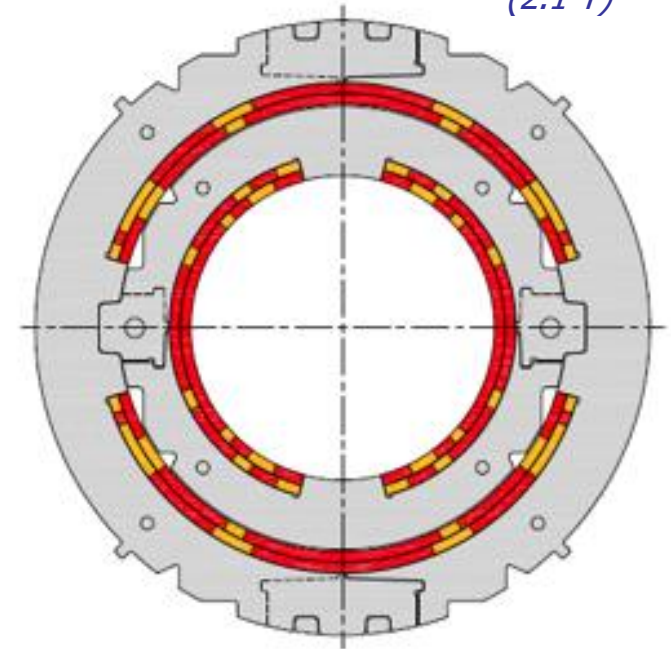
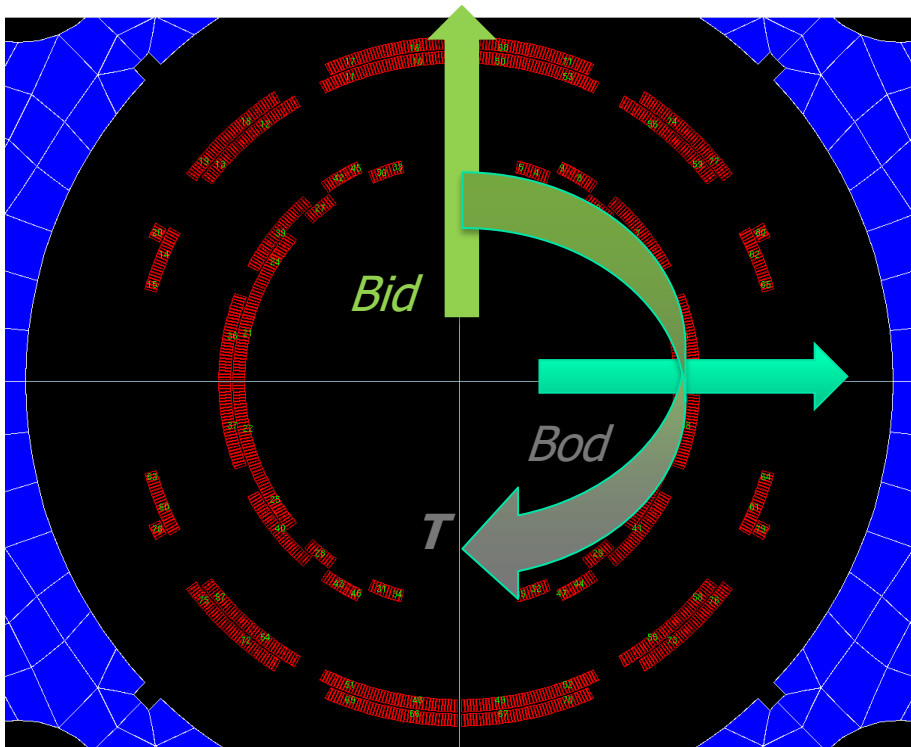
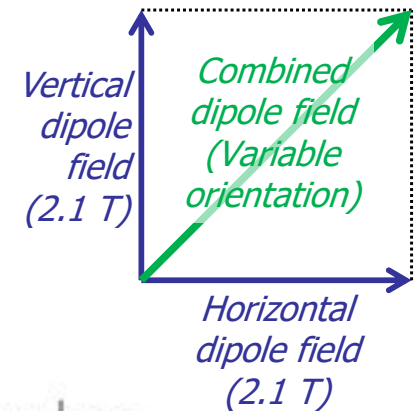

J. García-Matos, PhD Thesis

MCBXF prototypes: poor training in combined powering

- In case of problems, look at the information that you can gather:
 - Visual inspection
 - Powering tests
 - Effects of design modifications: preload increase did not change the test results
- The quench could be triggered by shear stress between cable blocks and end spacers.

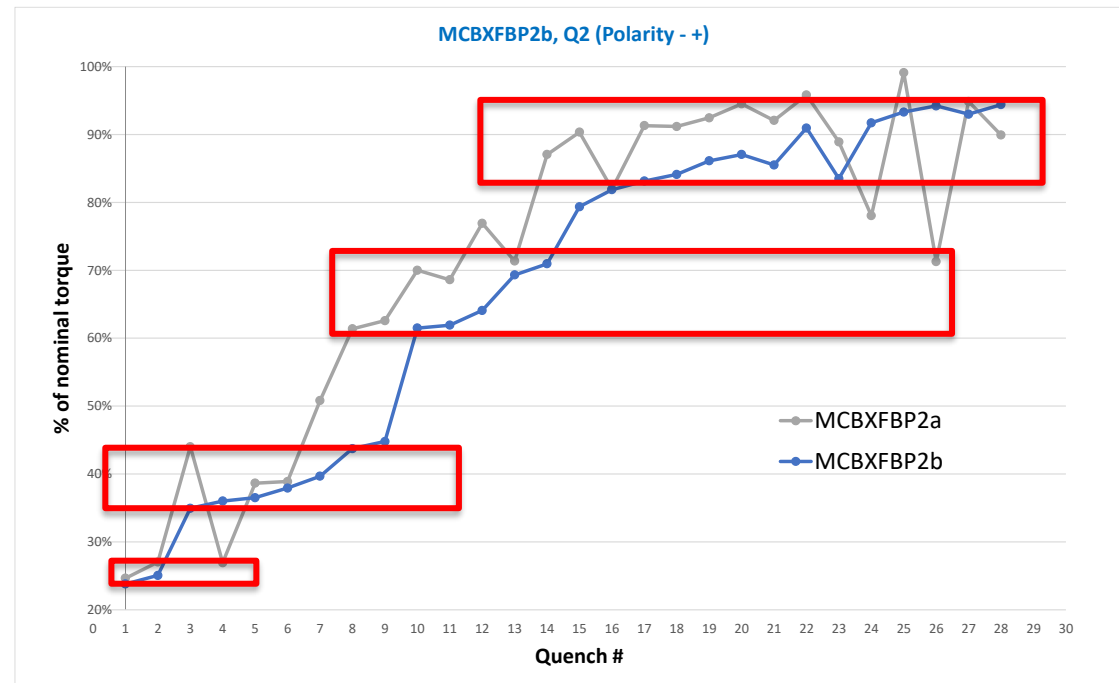

MCBXF: unsupported coil ends

- Coil ends are not supported under torque.
- Removing the iron is not effective.
- The torque at the coil end is the same to provide the same integrated fields.

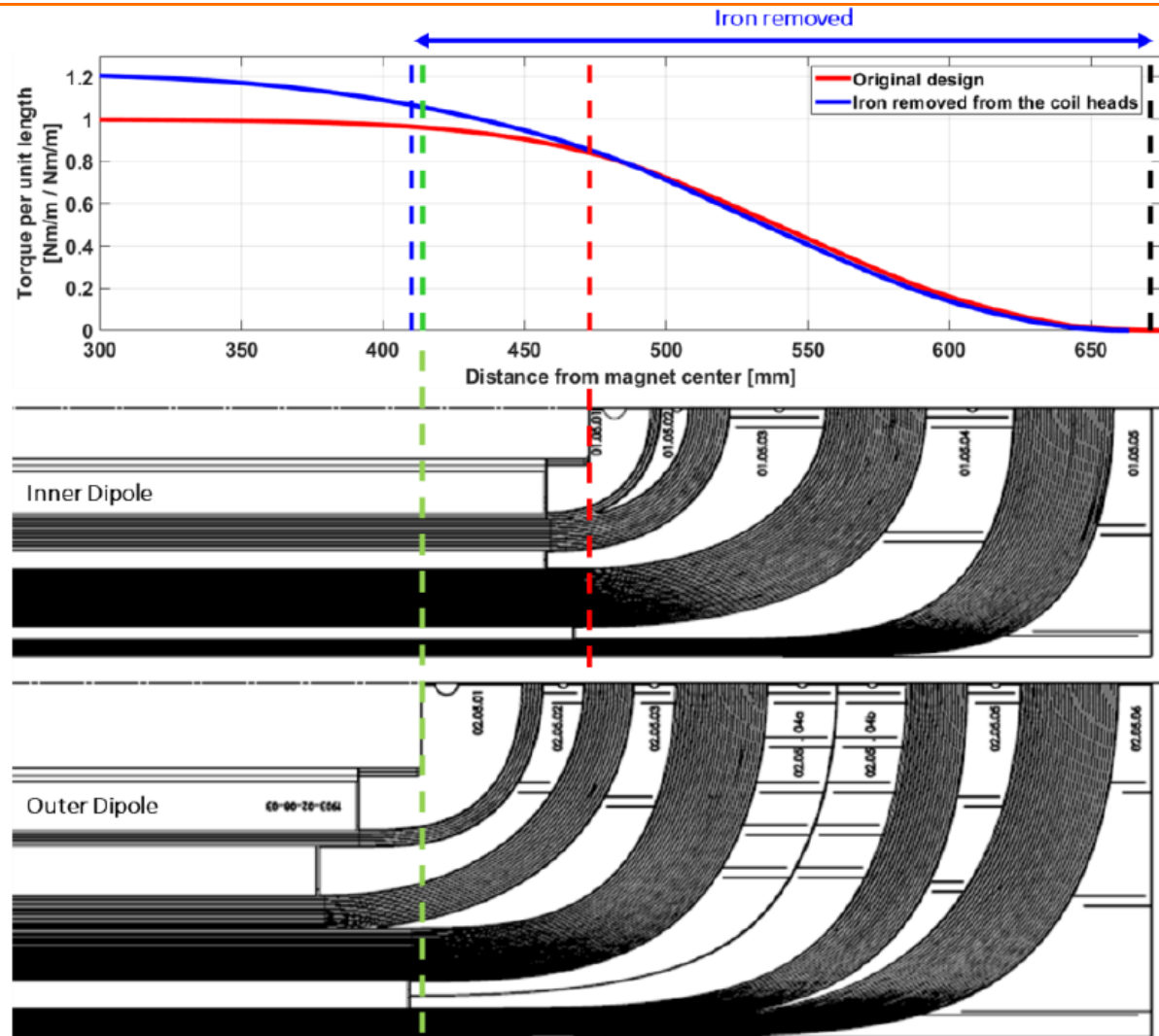
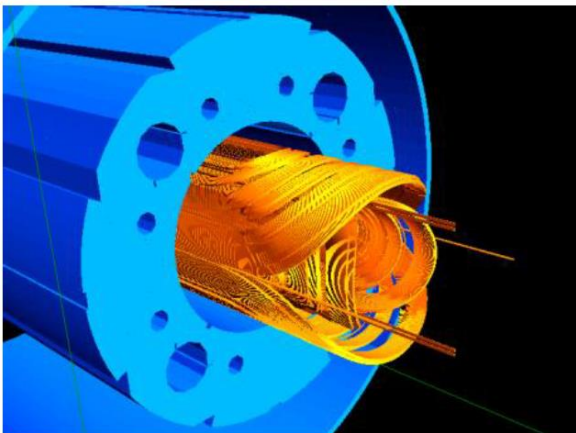

MCBXF: fine-tuning of the design (I)

- The **inner dipole coil is shortened**: both pole windows have the same length.
- In the initial section of the coil end, the torque is higher to provide the same integrated fields, but...
- The angular deformation of a tube depends on the **square** of the length.
- First check with a simple FEM model.

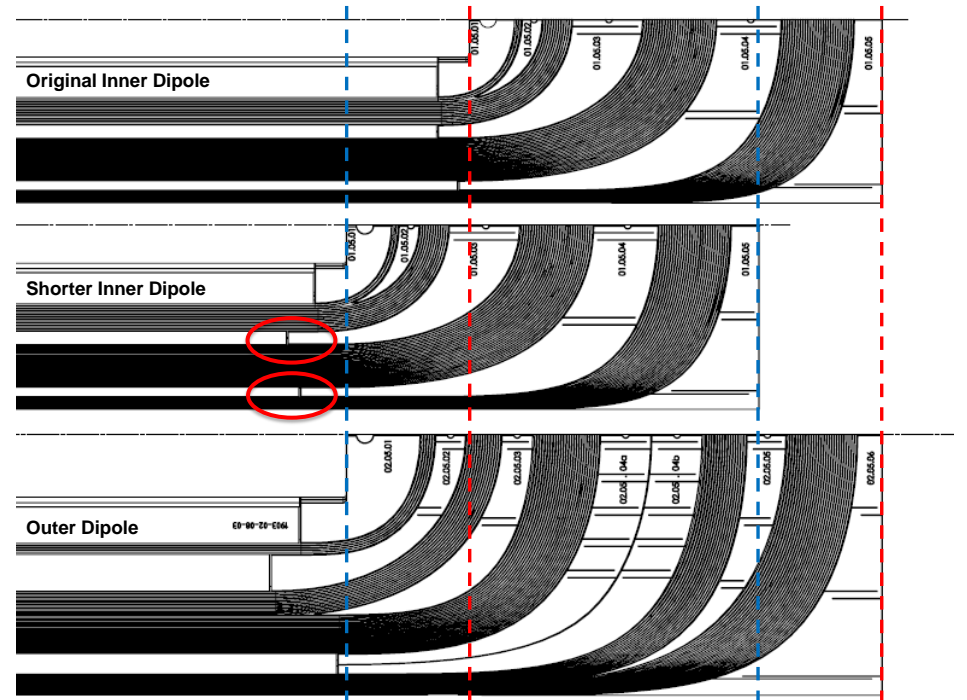
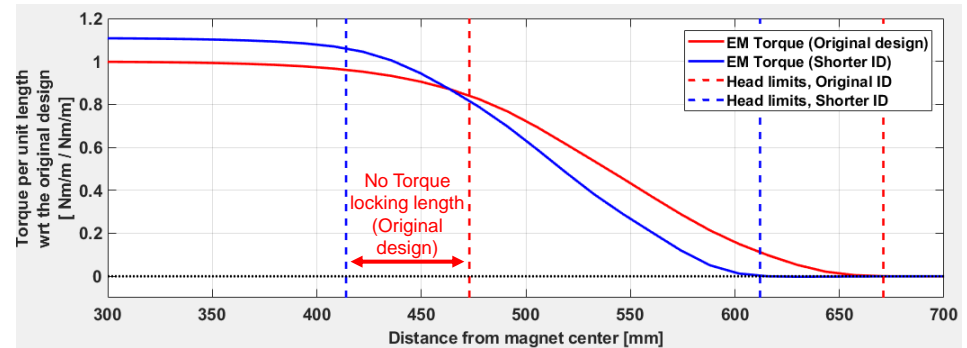
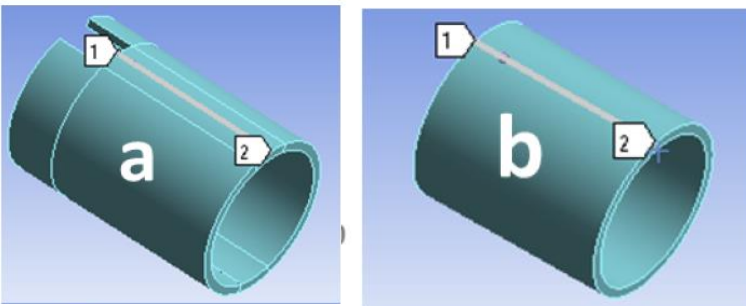

J. García-Matos, PhD Thesis

MCBXF: fine-tuning of the design (II)

- End spacers are also enlarged to increase the rigidity of the coil end.

Old end-spacer configuration

New end-spacer configuration

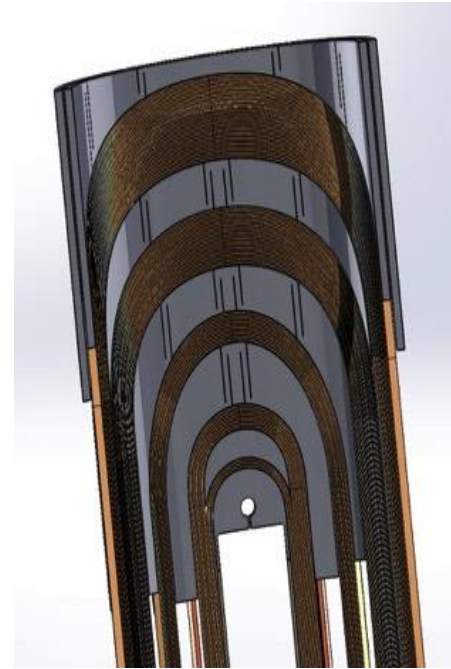
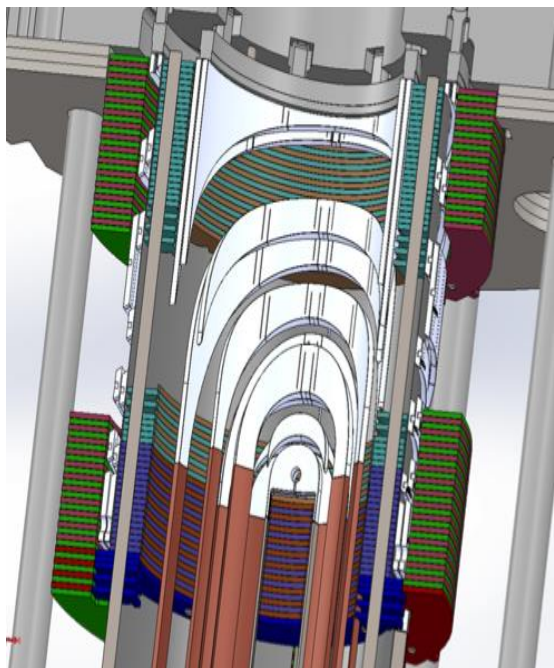

MCBXF: fine-tuning of the design (III)

- Final results with a more detailed 3D model.
- Outer dipole is not modeled: torque computed with Roxie.
- Smearred-out properties.

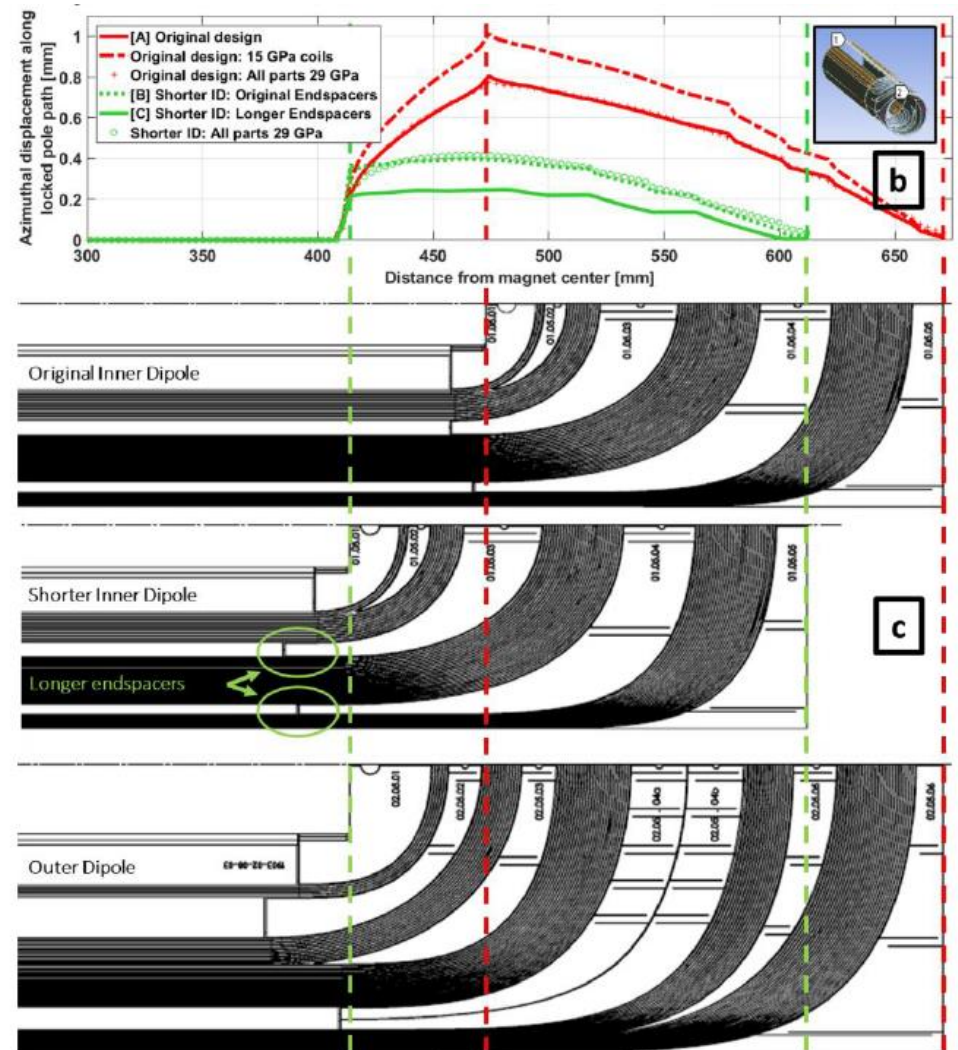
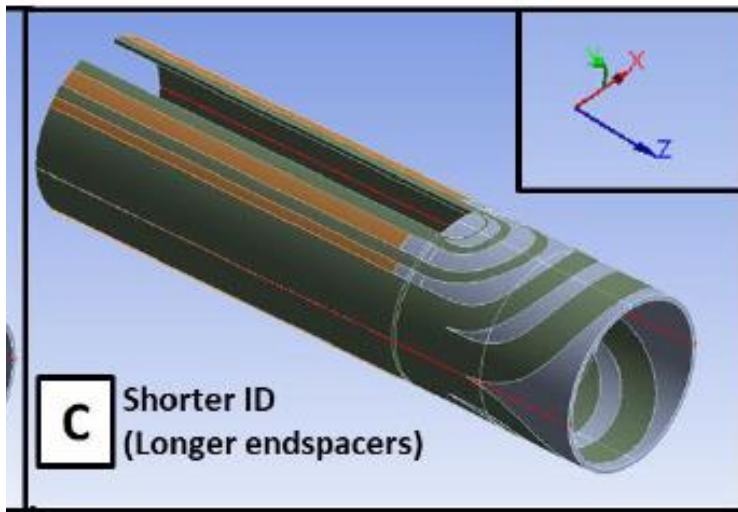

MCBXF: test results

- Successful test results with the fine tuning of the design!!!
- Magnet is tamed!
- Never lose your faith. Keep thinking! Trust on numbers and equations.

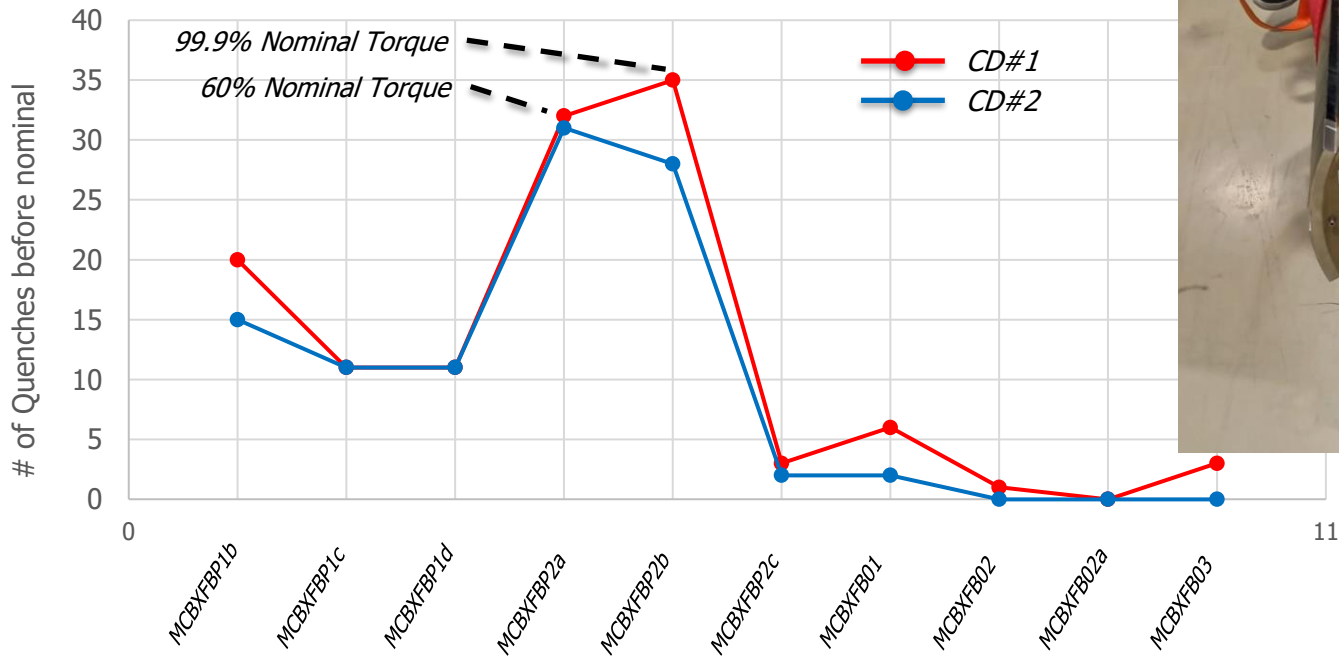

J. García-Matos, PhD Thesis

Outline

- Motivation
- Basic concepts
- Solenoids
- Accelerator magnets:
 - Coil dominated field:
 - Winding approximations: thin shell, thick shell, sector.
 - End forces.
 - Support structures: low, high and very high field magnets.
 - Iron dominated field.
- Toroids
- Final example
- Measurement techniques

Support structures: very high field magnets

- Let's call very high field magnets those beyond 10 T.
- Most of the collared magnets presented so far are characterized by significant coil pre-stress losses:
 - The coil reaches the maximum compression (about 100 MPa) during the collaring operation.
 - After cool-down the residual pre-stress is of about 30-40 MPa.
- What if the "required" coil pre-stress after cool-down is greater than 100 MPa?

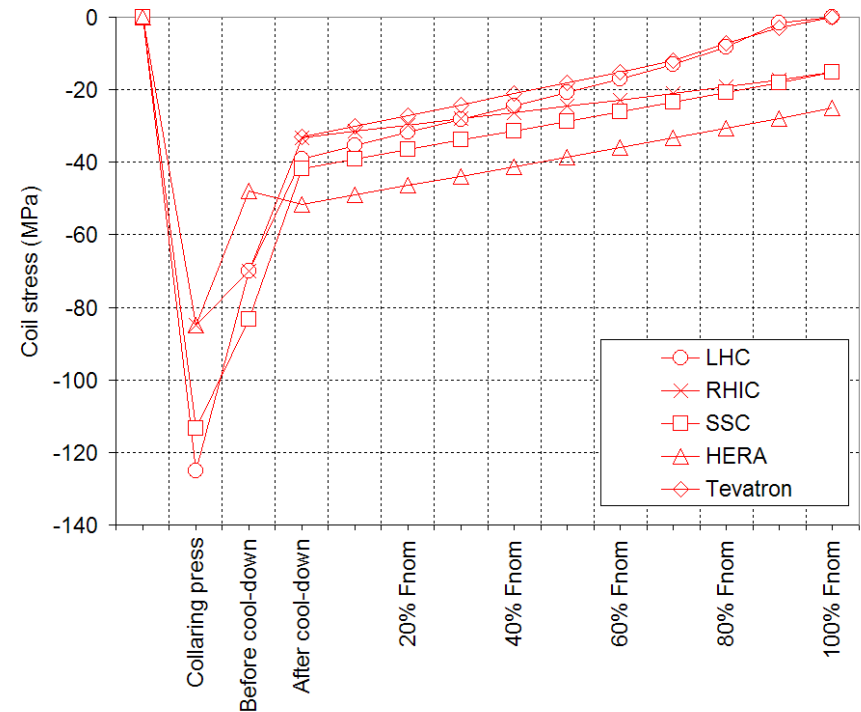

P. Ferracin [5]

Very high field magnets: aluminum shell (I)

- One solution consists of using an aluminum shell to provide the pre-load.
- The TQ quadrupole coil is surrounded by four pads and four yokes, which remain open during all the magnet operations.
- Initial pre-compression is provided by water-pressurized bladders and locked by keys.
- After cool-down the coil pre-stress increases due to the high thermal contraction of the aluminum shell.

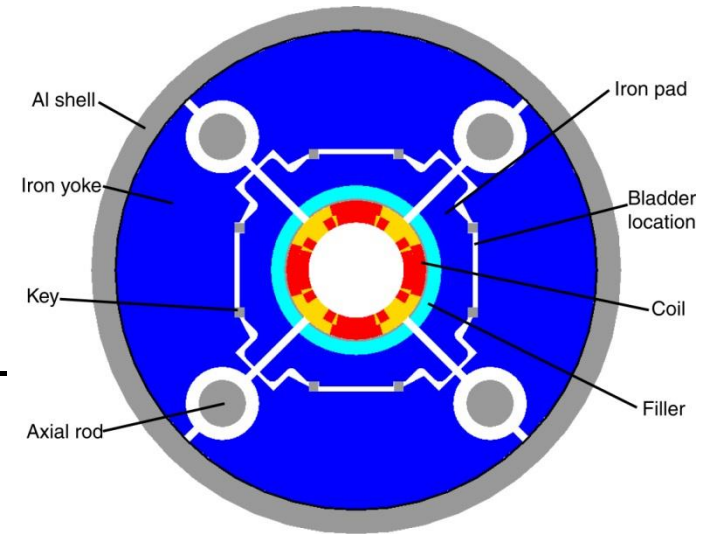

P. Ferracin [5]

Very high field magnets: aluminum shell (II)

- In the case of TQS prototype quadrupole (LBL+FNAL), the collaring press operation was substituted by the bladder operation.
- A spring back occurs when bladder pressure is reduced, since some clearance is needed for key insertion.
- The coil pre-stress significantly **increases** during cool-down.
- This approach has been successfully implemented in one of the HL-LHC magnets: **MQXF** (140T/m gradient in 150 mm aperture).
- It is specially good for **superconductors sensitive to high pressures**.

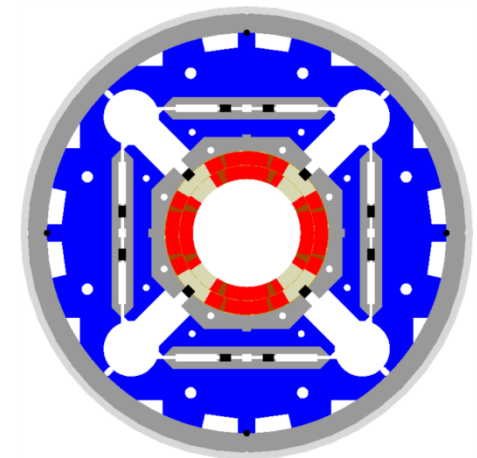
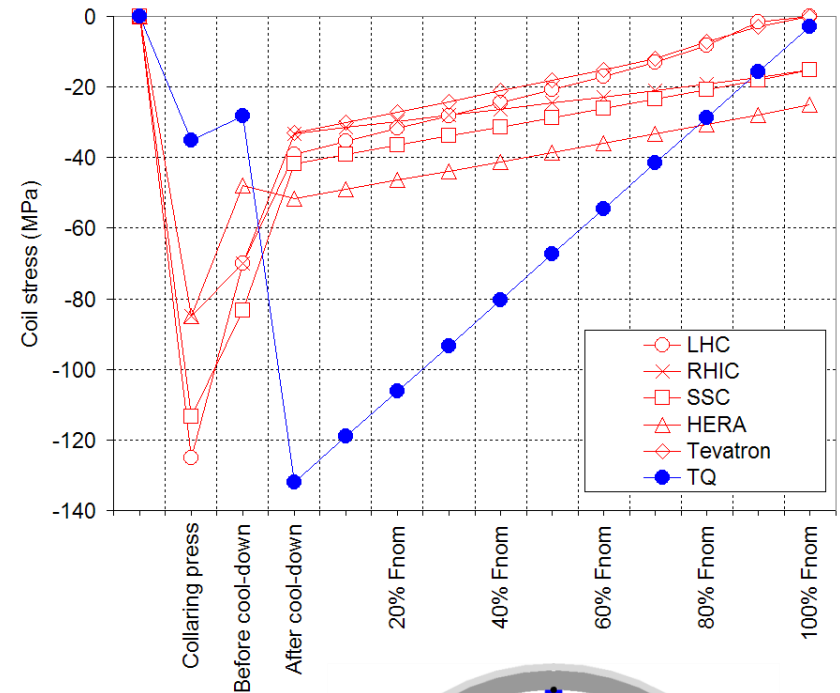

P. Ferracin [5]

Support structures: aluminum shell vs. collars

E. Todesco

■ Advantages:

- Better control of stress
- Maximum stress is reached at 1.9 K, when it is needed
- No heavy tooling

■ Disadvantages

- Contrary to collars, you do not impose position but you impose stress – so field quality could be more problematic (but FQ is found to be good)

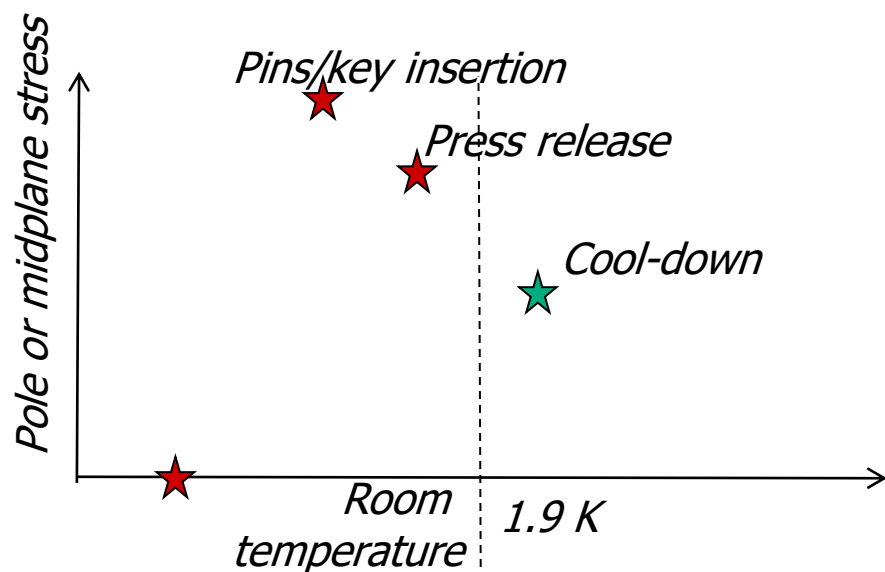

Stress during assembly and cool-down, collars

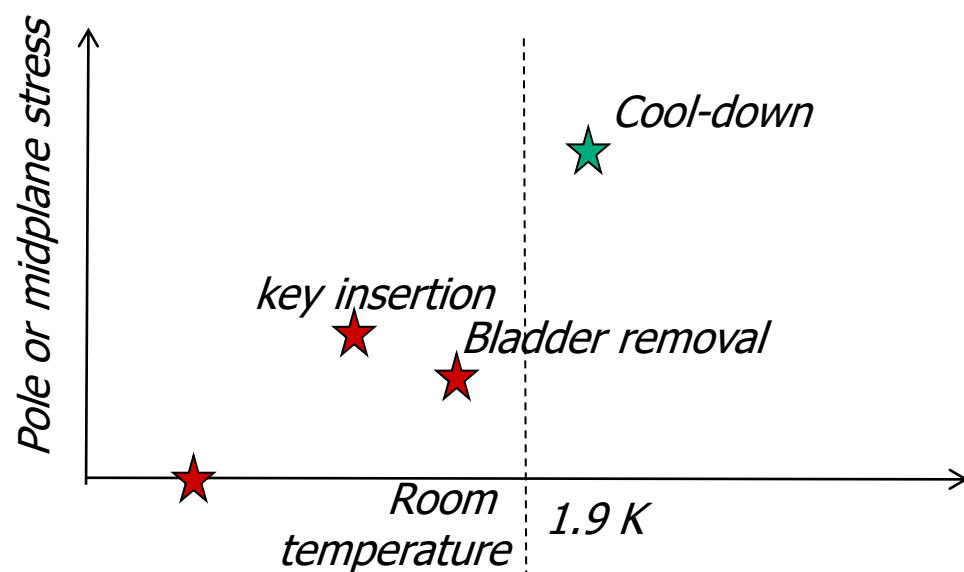

Stress during assembly and cool-down, Al shell

VHFM: block magnets

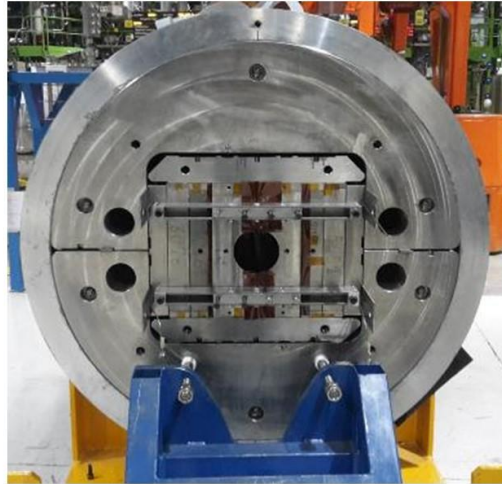
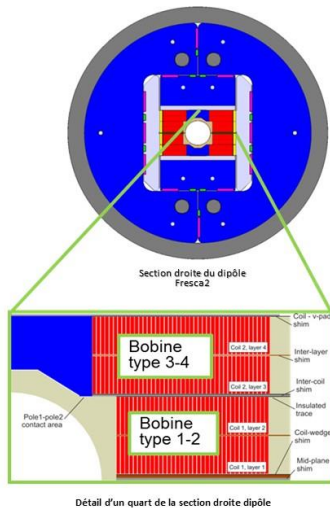

FRESCA2 magnet (CEA, CERN)

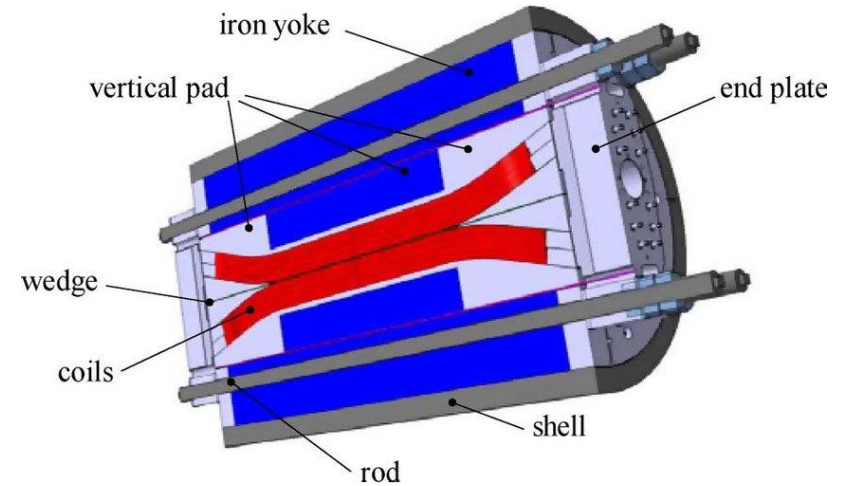

R2D2 = Research Racetrack Dipole Demonstrator

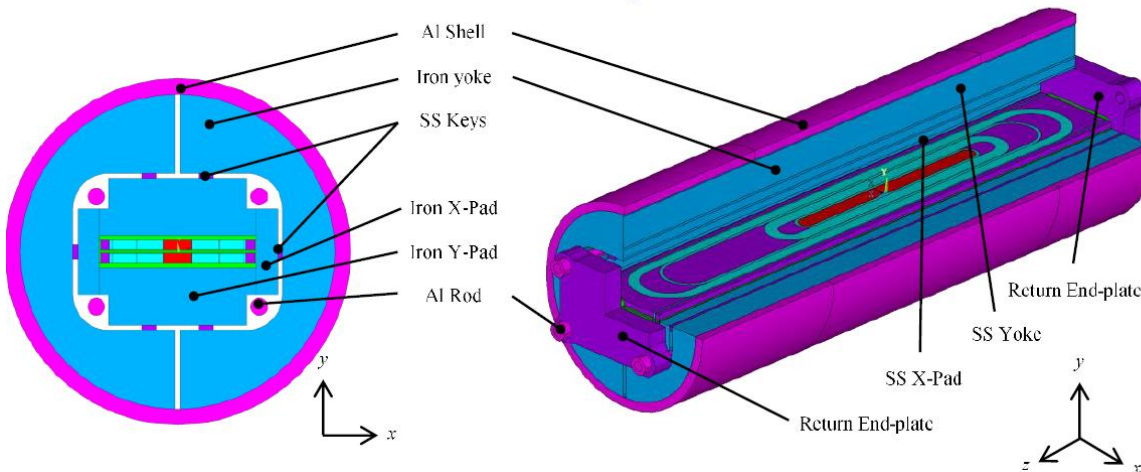

Aperture	None
Outer diameter	480 mm
Structure length	2.0 m
Nominal central field	11.1 T
Ultimate central field	12.0 T
Nominal peak field	12.7 T
Ultimate peak field	13.7 T

E. Rochepault

VHFM: common coil magnets

A dipole powered like a quadrupole.

- The yoke is used as **support structure**
- Upper part is made in **stainless steel**: it may help to contain the large Lorentz horizontal force
- **Aluminium shell** also contributes to hold the forces
- The coil would lose **contact** with this part during cooling down: it could move horizontally without friction
- Assembly with **bladder and keys** is not modeled yet
- Slight **preload** just to keep contact between parts

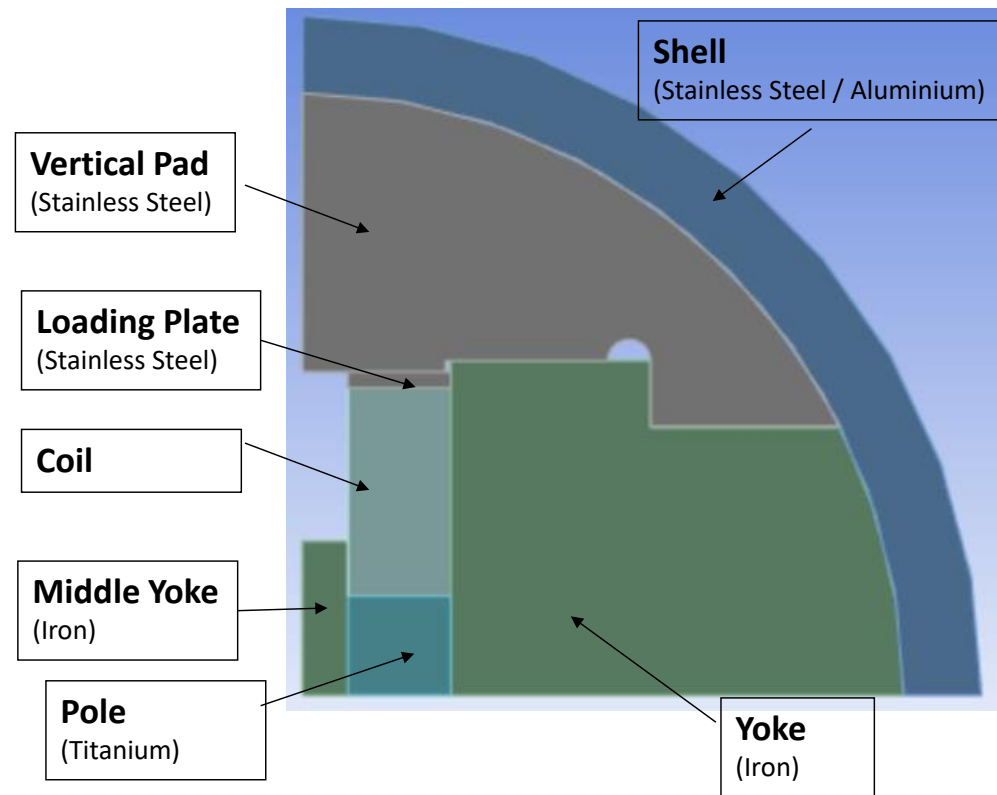

Courtesy C. Martins

VHFM: stress management of a coil block

- A novel stress management system (TAMU, Texas A&M) is based on intermediate coil supports.
 - Each coil block is isolated in its own compartment and supported separately.
 - Lorentz force exerted on multiple coil blocks does not accumulate, but it is transmitted to the magnet frame by the Inconel ribs to Inconel plates.
 - A laminar spring is used to preload each block.

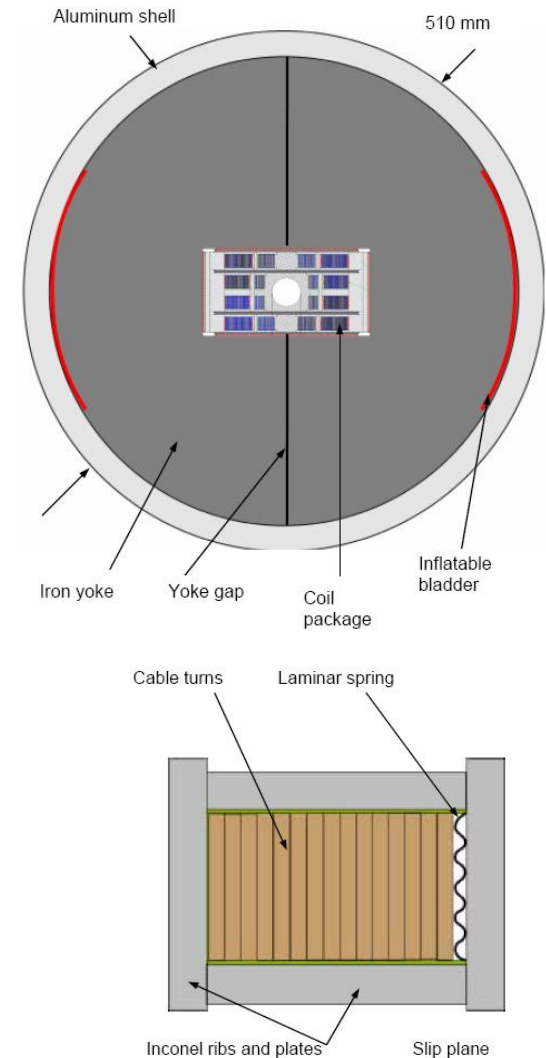
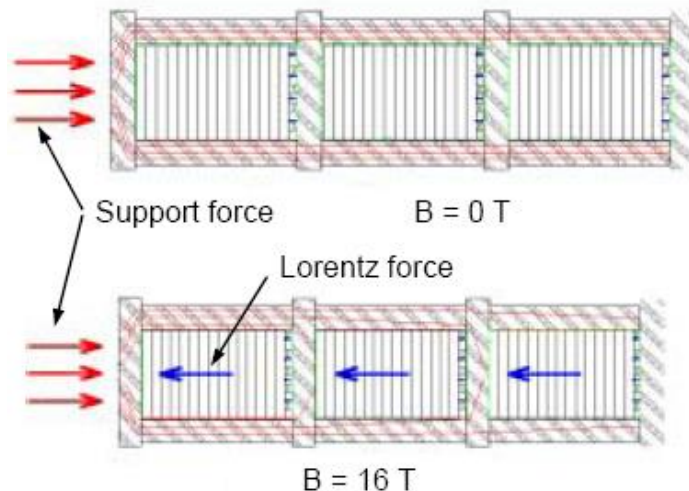

C. Goodzeit [7]

VHFM: cos-theta stress management



- A cos-theta magnet with stress management is under development in Fermilab (A. Zlobin et al).

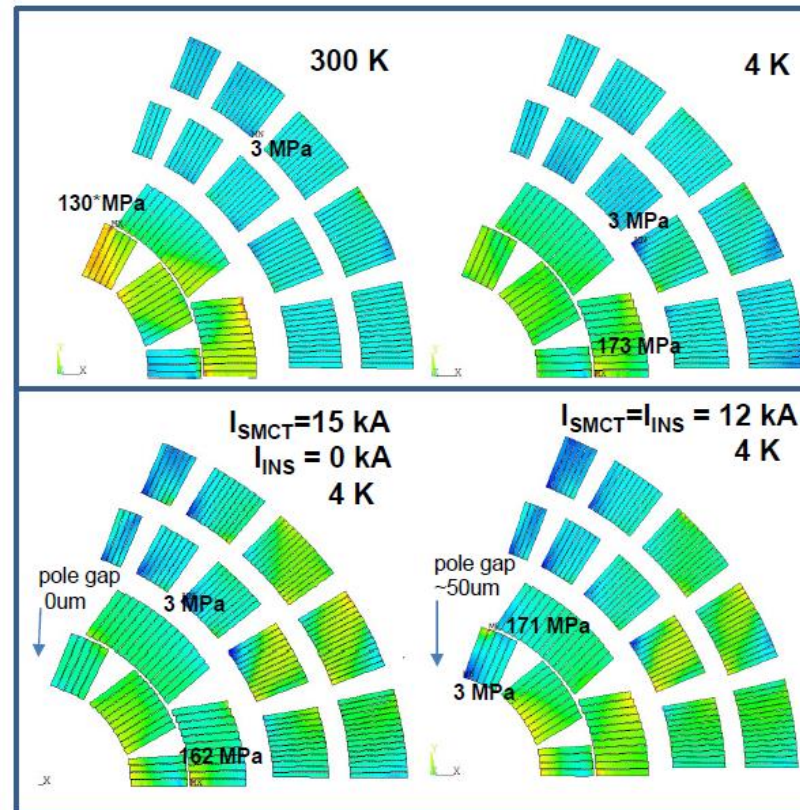

VHFM: canted cos-theta stress management

- Each cable is supported by a rib, and each layer has its own former.
- Efforts made at LBNL and PSI.

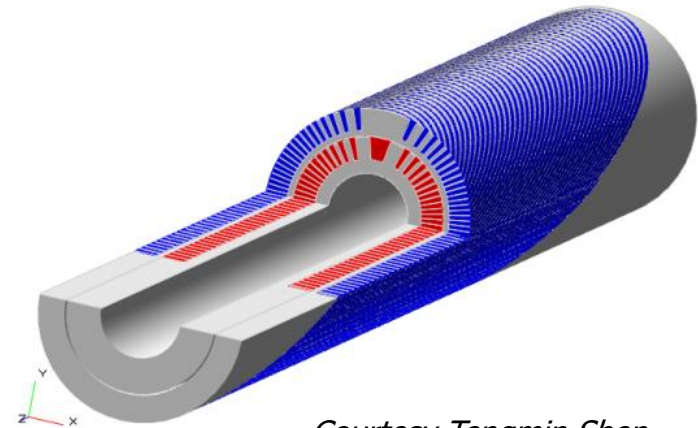
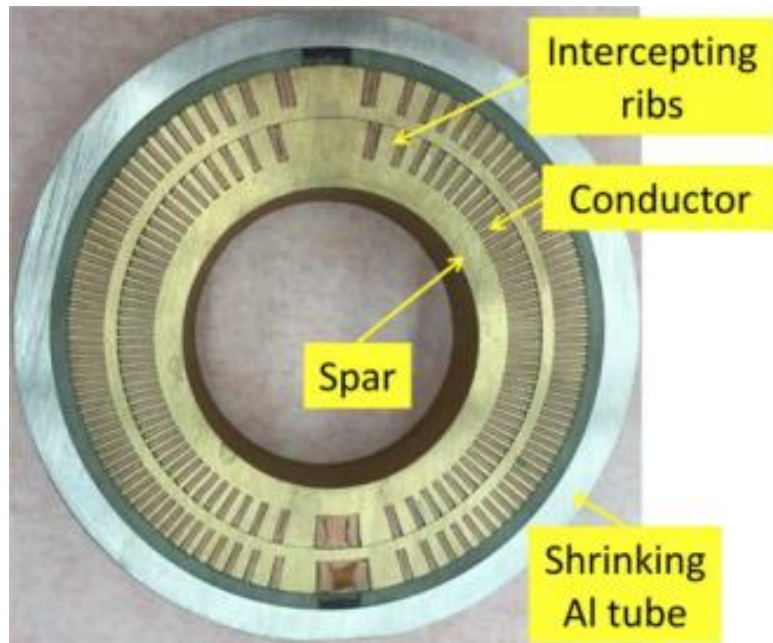

Courtesy Tengmin Shen

Courtesy E. Todesco

Pre-stress: controversy (I)

- As we have seen, the pre-stress avoids the appearance of tensile stresses and limits the movement of the conductors.
- **Controversy: which is the right value of the pre-stress?**
- In Tevatron dipoles, it was learnt that there was not a good correlation between small coil movements (<0.1 mm) and magnet learning curve.
- In LHC short dipole program, the coils were unloaded at 75% of nominal current, without degradation in the performance.
- In LARP TQ quadrupoles:
 - With low pre-stress, unloading but still good quench performance
 - With high pre-stress, stable plateau but small degradation

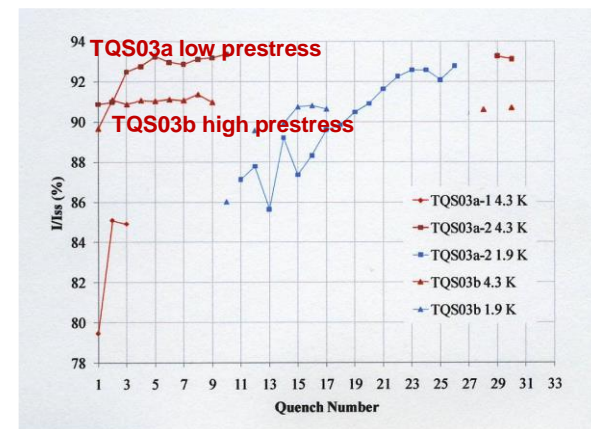
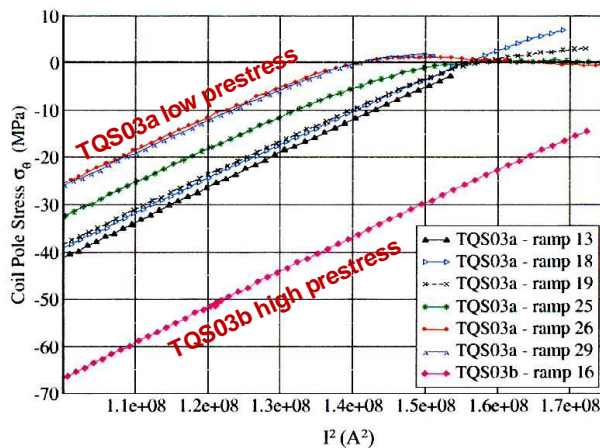

P. Ferracin [5]

Pre-stress: controversy (II)

- In LHC corrector sextupoles (MCS), a **specific test program** was run to find the optimal value of pre-stress.
- Coils were powered under different pre-compressions immersed in the same field map than the magnet:
 - Learning curve was poor in free conditions.
 - Training was optimal with low pre-stress and around 30 MPa. Degradation was observed for high pre-stress (above 40 MPa).
 - Finally, nominal pre-stress for series production was 30 MPa

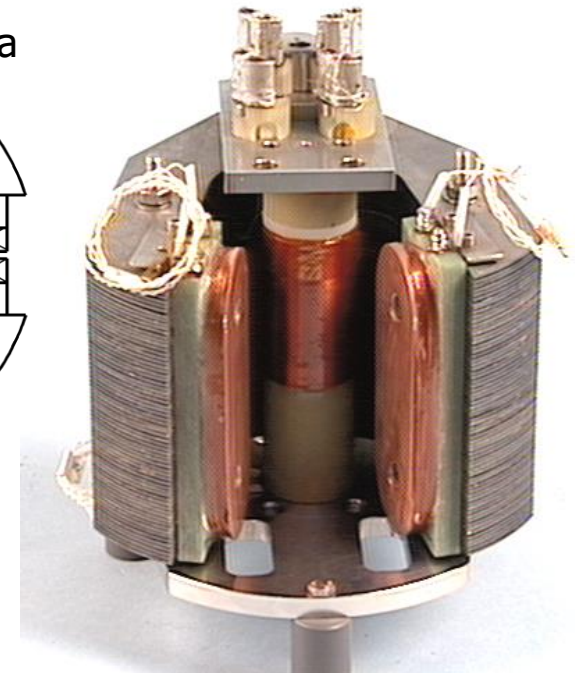
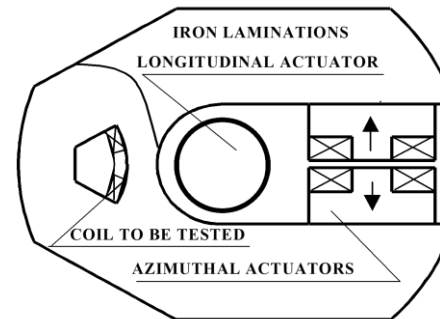
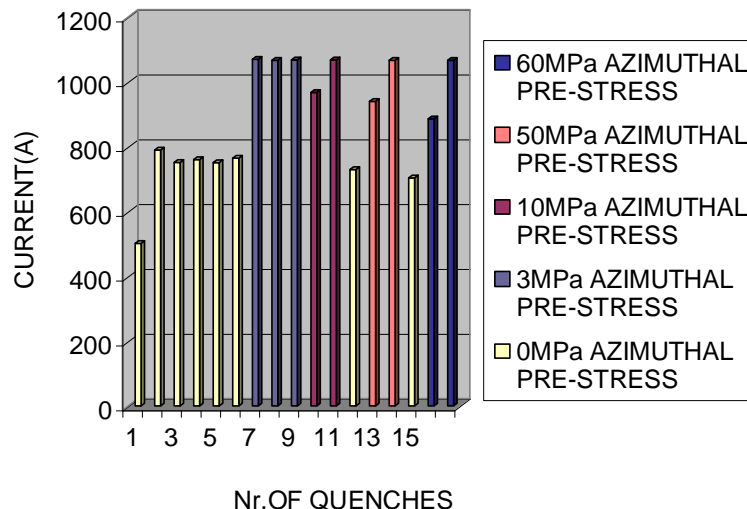

M. Bajko et al., "Training Study on Superconducting Coils of the LHC Sextupole Corrector Magnet", LHC Report 236, 1998

What have we learnt by now?

- **Pre-compression** is the classical way to avoid tensile stresses on the coils when energizing a superconducting magnet.
- There is not a unique solution for every magnet.
- Different construction/design methods, depending on the electromagnetic force/field values:
 - Low field: shrinking outer shell
 - High field: collars + outer shell, iron support
 - Very high field: bladder and keys, intermediate coil supports.
- If a magnet training does not improve from 4.2 to 1.9K, there is likely a mechanical limitation.
- **Controversy: which is the right value of pre-compression?**

Outline

- Motivation
- Basic concepts
- Solenoids
- Accelerator magnets:
 - Coil dominated field:
 - Winding approximations: thin shell, thick shell, sector.
 - End forces.
 - Support structures: low, high and very high field magnets.
 - Iron dominated field.
- Toroids
- Final example
- Measurement techniques

Superferric accelerator magnets (I)

- The stress distribution in the coil is different from that in the $\cos\theta$ magnets: when powered, each coil experiences in-plane expansion forces, and it is usually attracted by the iron.
- In small magnets, simple support structures (like wedges) are sufficient to hold the coils.

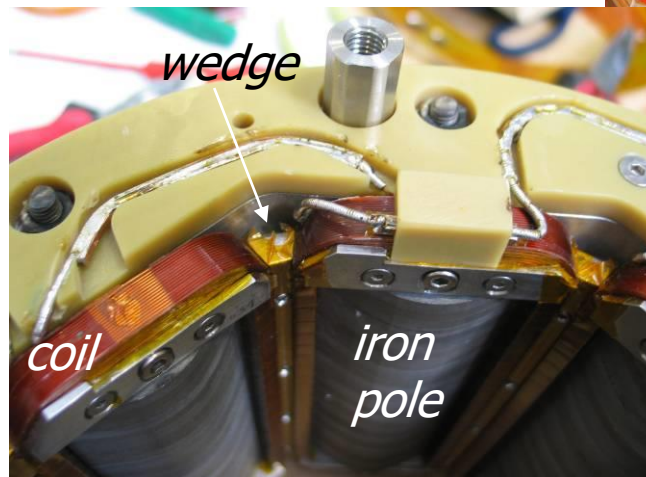
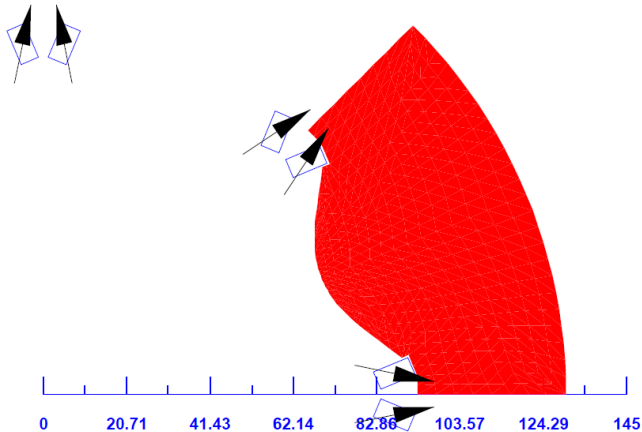

F. Toral et al. "Development of Radiation Resistant Superconducting Corrector Magnets for LHC Upgrade", ASC 2012

Superferric accelerator magnets (II)

- Large superferric magnets are very common in fragment separators (NSCL-MSU, RIKEN, FAIR) and particle detectors (SAMURAI, CBM).
- Usually, the **iron is warm**. Then, the Lorentz forces on the coil are hold by a stainless steel casing which is also the helium vessel. In some cases, part of these forces may be transferred to the external structure by means of low-heat-loss supports.

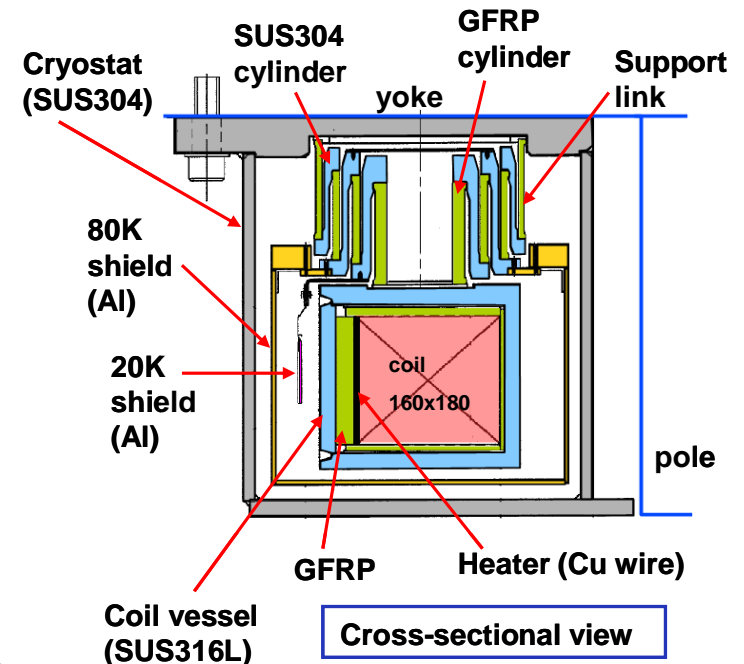
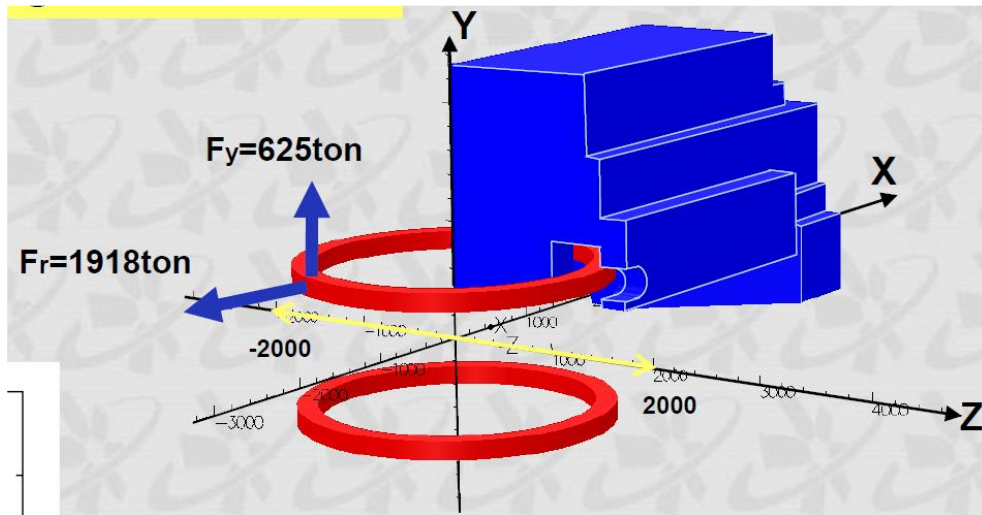

H. Sato, "Superconducting Dipole Magnet for SAMURAI Spectrometer", ASC-2012

Outline

- Motivation
- Basic concepts
- Solenoids
- Accelerator magnets
- **Toroids**
- Final example
- Measurement techniques

Toroids (I)

- As the magnetic pressure varies along the coil, it is subjected to strong bending forces.
- If one wants to simplify the support structure:
 - Each coil experiences a **net force towards the centre** because the field is strongest there: it is wise to flatten the inner edge of the coil, to lean on a support structure.
 - The rest of the circumference will distort to a shape working under pure tension, where no bending forces are present. This tension must be constant around the coil. Assuming R as the distance to the center and ρ the local radius of curvature of the coil, the condition for local equilibrium would be:

$$T = B(R)I\rho = \text{constant}$$

$$B(R) = B_0 \frac{R_0}{R}$$

$$\rho = \frac{\left\{1 + \left(\frac{dR}{dz}\right)^2\right\}^{3/2}}{d^2 R / dz^2} = \frac{TR}{B_0 R_0 I} = KR$$

- There is no analytical solution. Figure on the right shows a family of solutions.

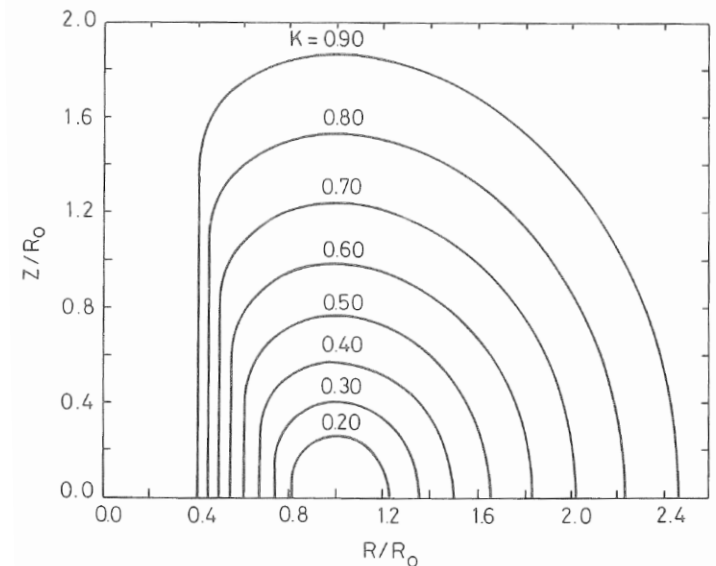

M. Wilson [2]

Toroids (II)

- Toroids are usual in fusion reactors. Nominal currents are large. Coils are used to be wound with **cable-in-conduit conductors** (CICC).
- **EDIPO** project: a superferric dipole to characterize conductors for ITER coils. Bore field is 12.5 T. Magnet length is 2.3 m.
- Lorentz forces are huge: $F_x=1000$ tons $F_y=-500$ tons $F_z=400$ tons

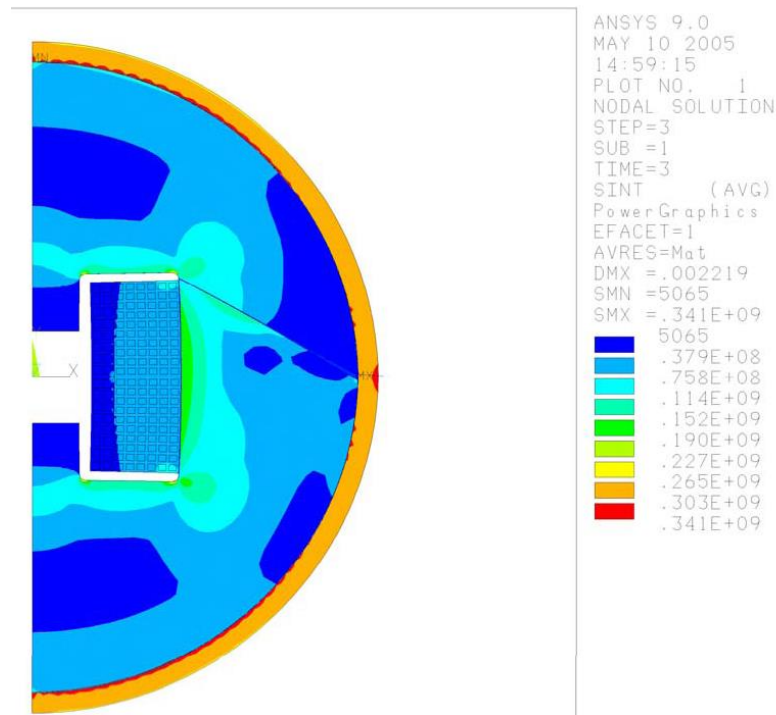

J. Lucas, EFDA dipole, 2005

Toroids (III)

- There are two different FEM models for **mechanical analysis**:
 - A **general model**, with less details, to study the support structure deformation.
 - A **sub-model** of the coil to analyze the stresses on the conductors, mainly in the insulation:
 - Lorentz forces are transferred as pressures
 - the contact with the support structure is modeled as a boundary condition

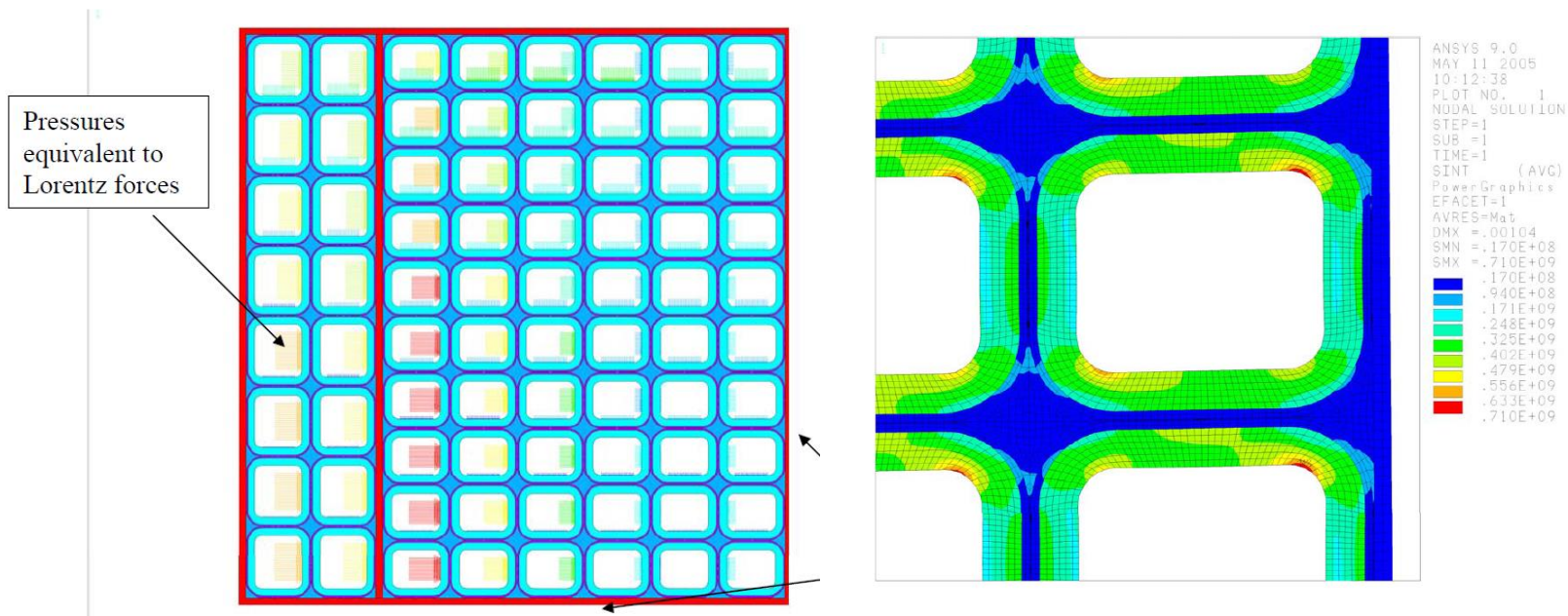

J. Lucas, EFDA dipole, 2005

Outline

- Motivation
- Basic concepts
- Solenoids
- Accelerator magnets
- Toroids
- **Final example**
- Measurement techniques

Final example: AMIT cyclotron (I)

- AMIT project (Sedecal-CIEMAT): a compact, 4T superconducting cyclotron. Iron pole radius is 175 mm.
- Warm iron concept.
- Electromagnetic forces between the coils can be attractive or repulsive, depending on the relative position and the current.
 - Design choice is repulsive, about 100 kN per coil.

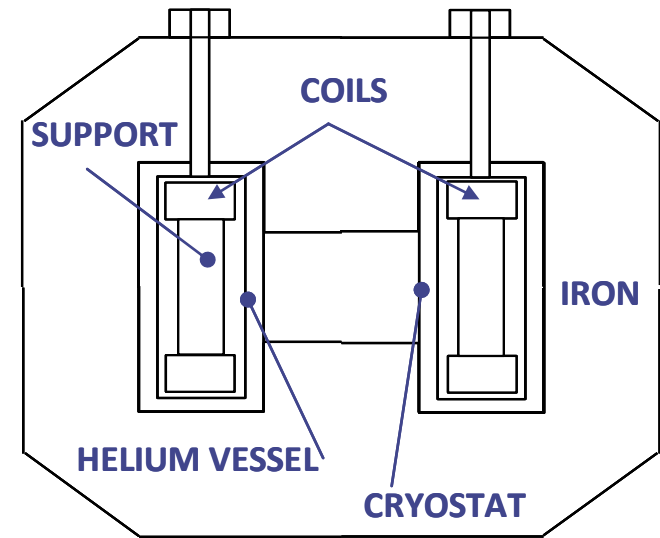

J. Munilla, CIEMAT, 2012

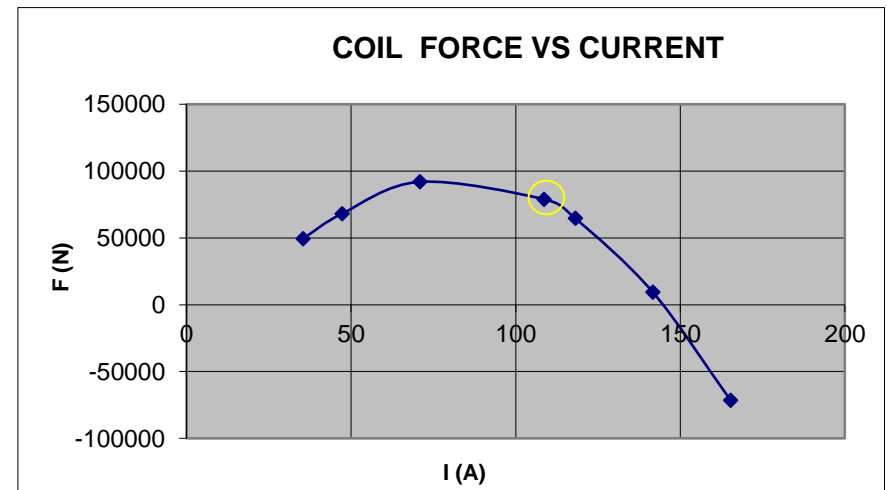
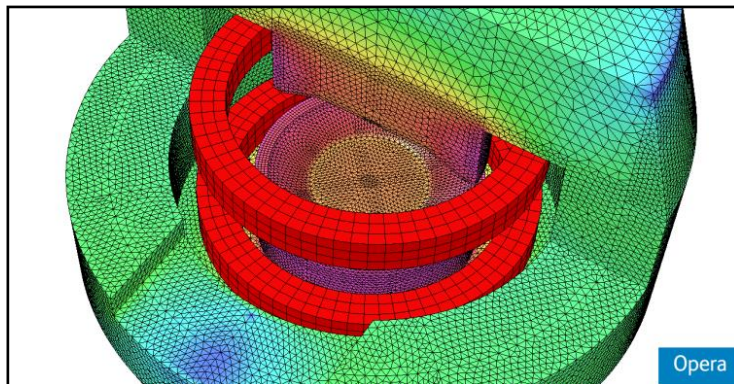

Final example: AMIT cyclotron (II)

- Support structure must hold:
 - Radial forces will induce a pressure in the winding. Since the coil is thick, it is very likely that **POSITIVE** radial stresses will appear in the center of the coil. In any case, they will induce high **HOOP** stresses in the superconductor.
 - Axial forces will pull both coils towards the iron, thus inducing **POSITIVE** axial stresses in the windings.
 - Axial forces will induce **BENDING MOMENTS** at the corners of the support structure (hollows are necessary to introduce the vacuum chamber).

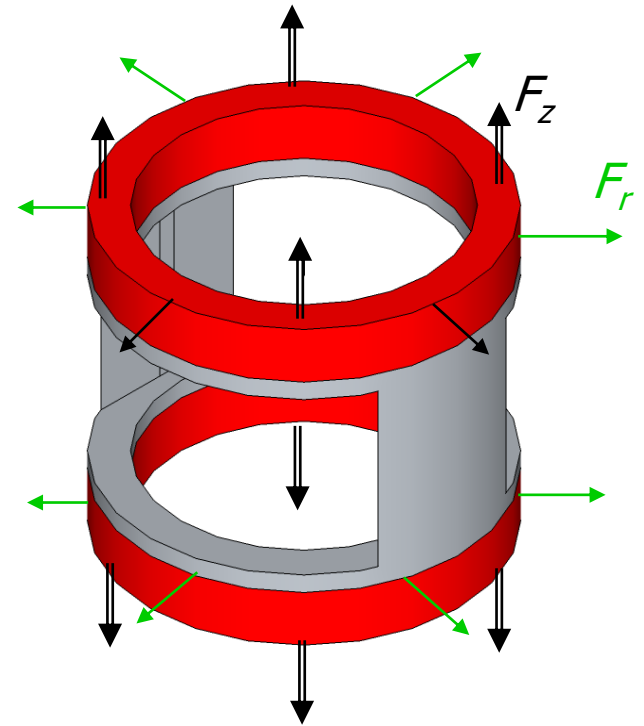

J. Munilla, CIEMAT, 2012

Final example: AMIT cyclotron (III)

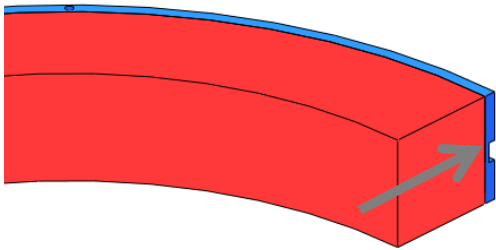

Path definition for stress evaluations:
FROM INTERNAL Face of COIL TO
EXTERNAL FACE of Shrinkage

Stresses in the coil and aluminum cylinder have been calculated at warm, cold and energized conditions. Figures show radial distribution of radial and hoop stresses in those conditions. Radial stresses in the coil are always negative while hoop stresses are positive and limited to 50 MPa in the coil and 150 MPa in the cylinder.

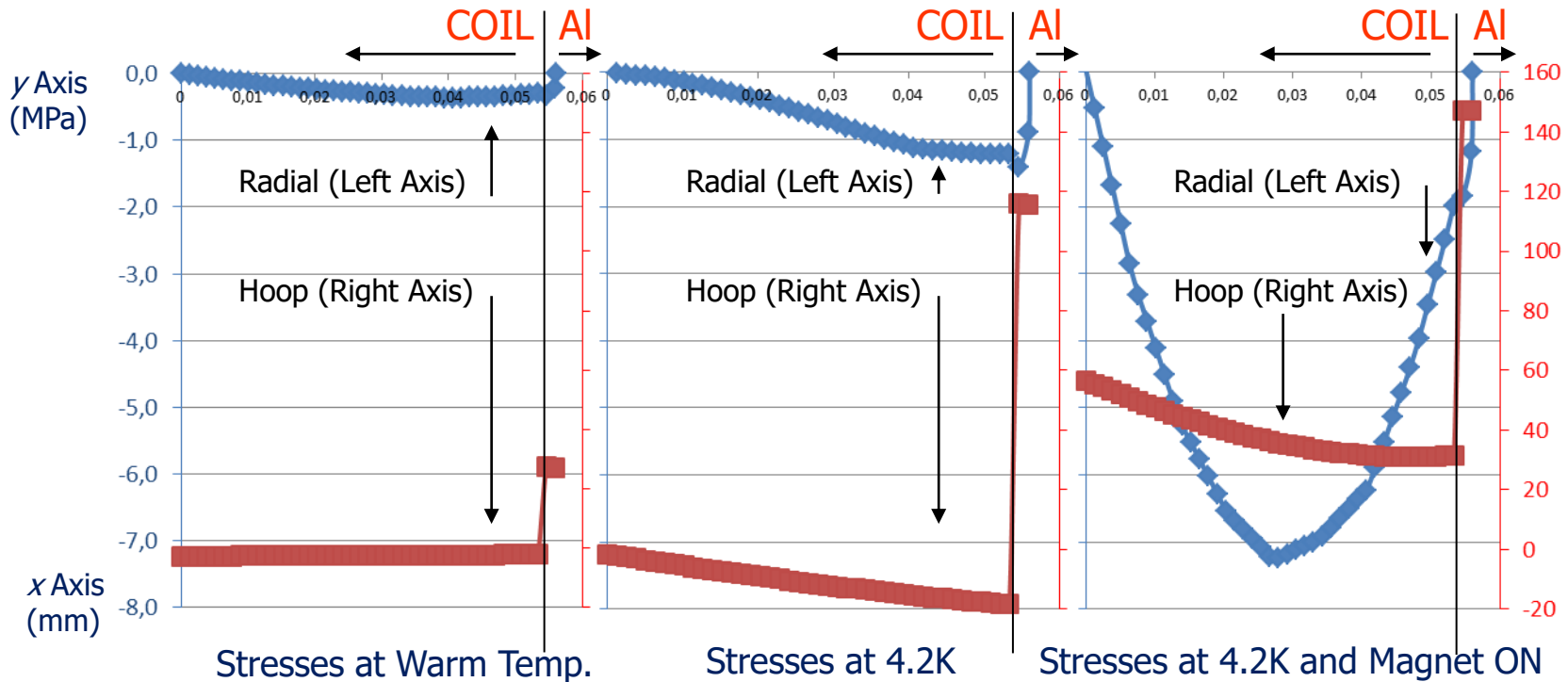

Final example: AMIT cyclotron (IV)

Stress distribution in the stainless steel support structure has been calculated from the magnetic forces and the thermal differential contractions using FEM. Maximum values are located in the corners (see figure) due to the bending moments induced by the axial magnetic forces. Their value is in the order of 80 MPa.

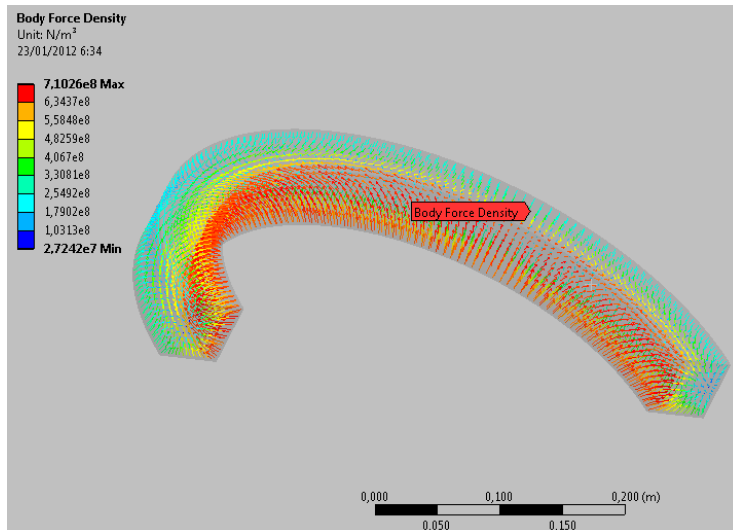

Magnetic Forces at Coil

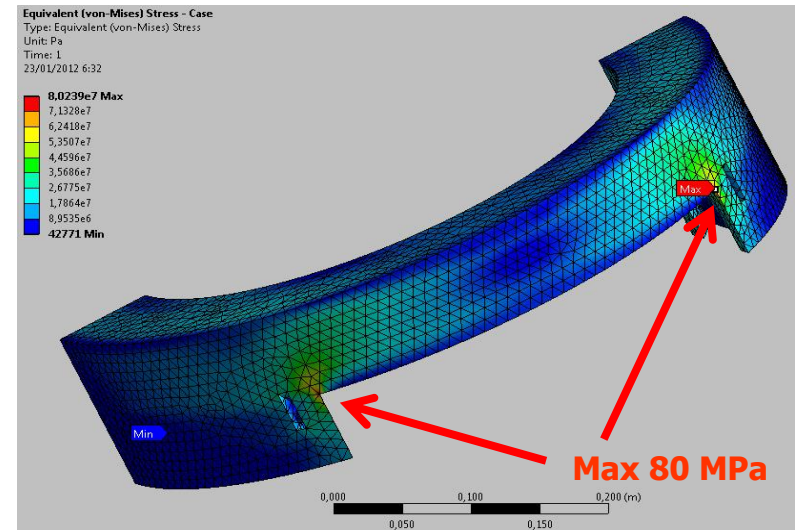

Stress distribution in the Structure

J. Munilla, CIEMAT, 2012

Final example: AMIT cyclotron (V)

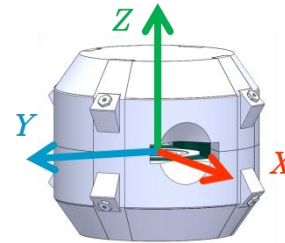
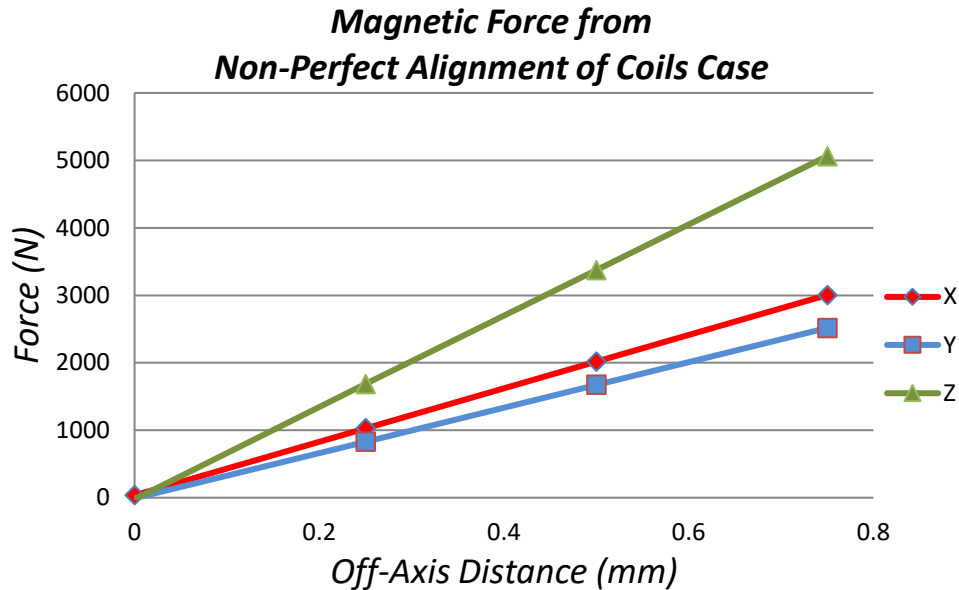

$$F_{xx} \sim 4000 \text{ N/mm}$$
$$F_{yy} \sim 3400 \text{ N/mm}$$
$$F_{zz} \sim 6700 \text{ N/mm}$$

When the coils are not centred with the iron poles, some forces will arise. These forces have been calculated in three axes (X & Y axes are different due to the presence of the vacuum chamber hole in the iron). The forces are in the direction of the misalignment with a positive slope (trying to increase the off-axis error).

J. Munilla, CIEMAT, 2012

Final example: AMIT cyclotron (VI)

Stresses in the supports have been calculated at both, centred and off-axis conditions. Upper rods will develop larger stresses since the coils hang from them on the one hand and they are used to align the magnet, developing thermal contractions on the other hand, while the lower rods are free until the magnet is cold and in position and then the nuts are closed exerting to them a certain tension to provide assembly stiffness.

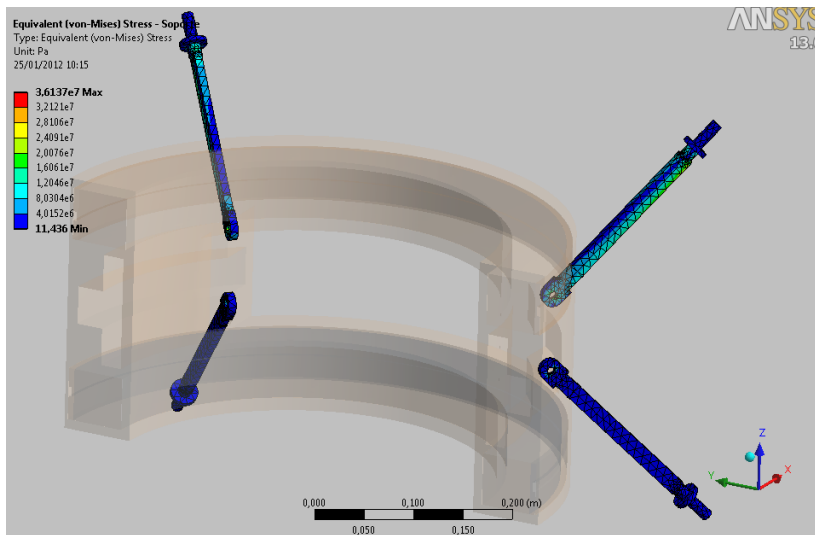

Stresses in the G10 Rods.
CONDITIONS: Cold, adjusted, magnet ON
Maximum value: 36 MPa

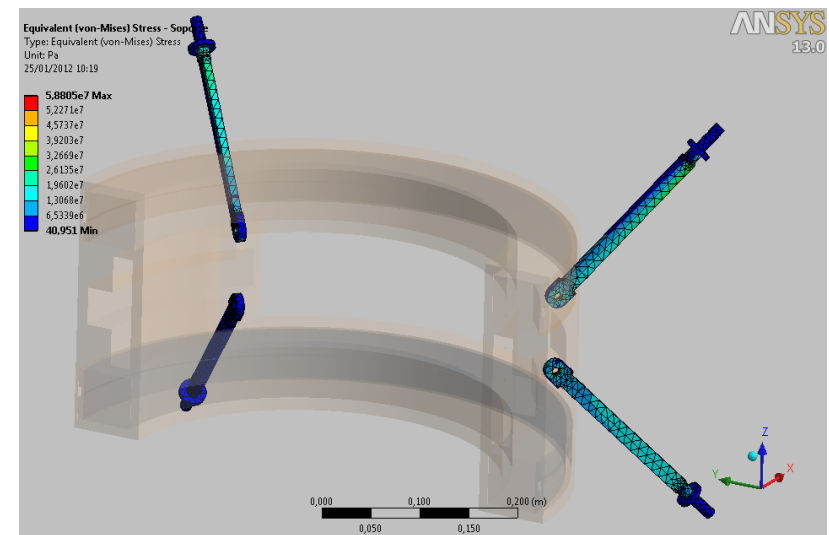

Stresses in the G10 Rods.
CONDITIONS: Cold, 0.5 mm off-Y axis, magnet ON
Maximum value: 59 MPa

Outline

- Motivation
- Basic concepts
- Solenoids
- Accelerator magnets
- Toroids
- Final example
- **Measurement techniques**

Measurement techniques: stress

- Capacitive gauge: the basic principle is to measure the variation of capacity induced by a pressure in a capacitor.
- Being S the area of the two parallel electrodes, δ the thickness of the dielectric, and ε the electric permittivity, the capacity C is given by

$$C = \varepsilon S / \delta$$

- When a pressure is applied, the capacity will change

$$C = \varepsilon S / \left[\delta \left(1 - \frac{\sigma}{E} \right) \right]$$

- Calibration: the capacity can be measured as a function of pressure and temperature.

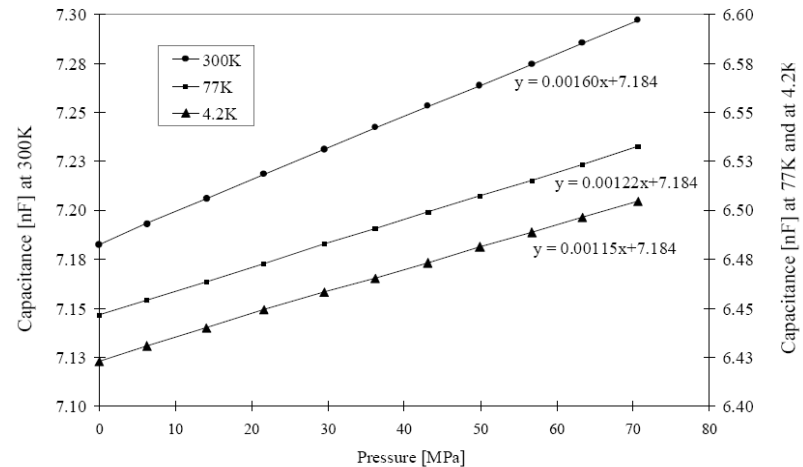
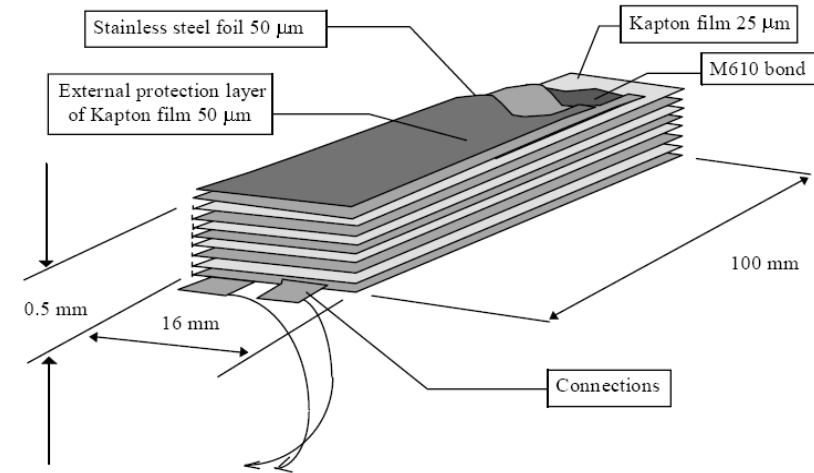
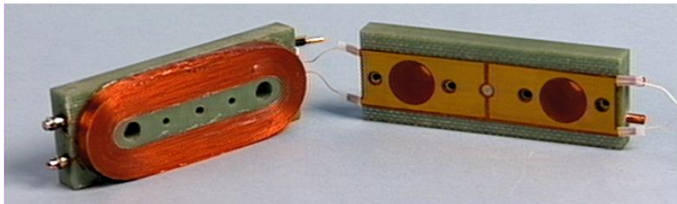

N. Siegel, et al., "Design and use of capacitive force transducers for superconducting magnet models for the LHC", LHC Project Report 173.

Measurement techniques: strain

- The basic principle is to measure the variation of resistance induced by a strain in a resistor.
- The gauge consists of a wire arranged in a grid pattern bonded on the surface of the specimen
- The strain experienced by the test specimen is transferred directly to the strain gauge.
- The gauge responds with a linear change in electrical resistance.
- The gauge sensitivity to strain is expressed by the gauge factor

$$GF = \frac{\Delta R / R}{\Delta l / l}$$

- The GF is usually ~ 2 .
- Gauges are calibrated by applying a known pressure to a stack of conductors or a beam.

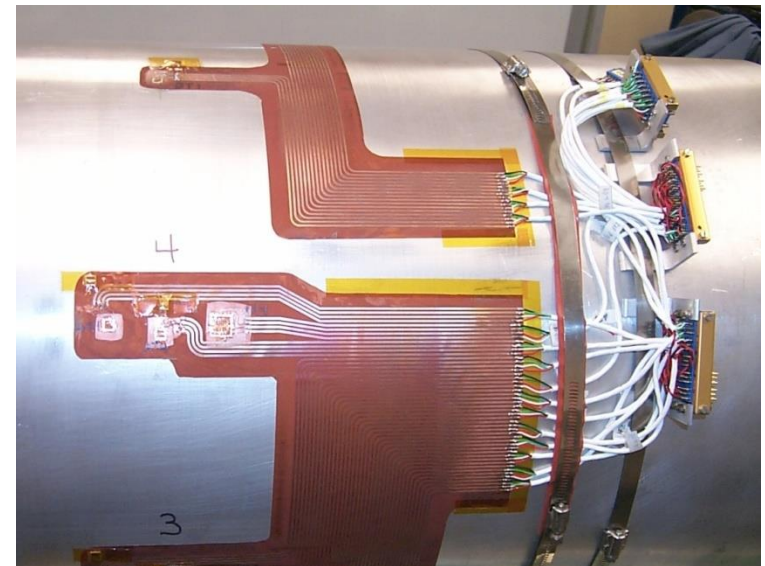
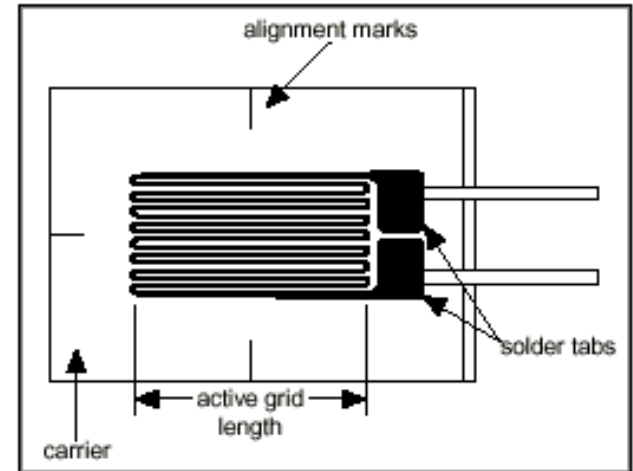

C.L. Goodzeit, et al., *IEEE Trans. Magn.*, Vol. 25, No. 2, March 1989, p. 1463-1468.

Measurement techniques: coil properties

- The elastic modulus E is measured by compressing a stack of conductors, usually called ten-stack, and measuring the induced deformation.
- The thermal contraction is given by

$$\alpha = \frac{l_{wo} - l_{co}}{l_{wo}}$$

where l_{wo} and l_{co} are the unloaded height of the specimen respectively at room and cold temperature.

- It can be also evaluated using the stress loss in a fixed cavity.

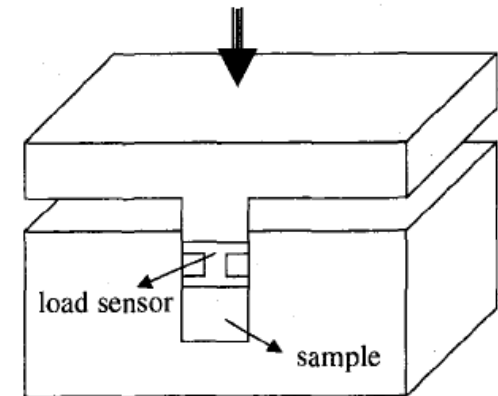
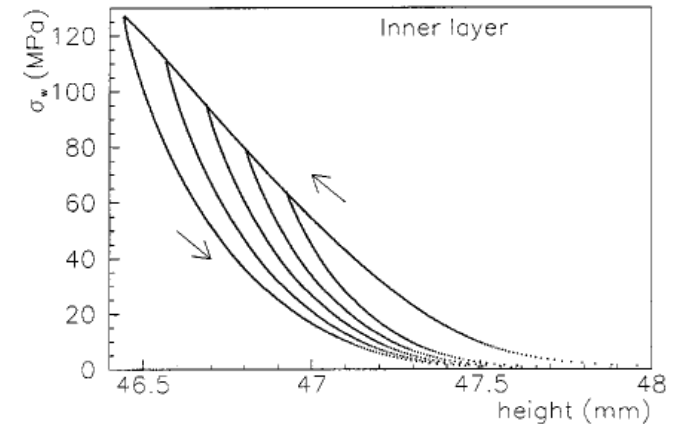

M. Reyrier, et al., IEEE Trans. Supercond., Vol. 11, Issue 1, March 2001, p. 3066 – 3069.

K.P. Chow and G.A. Millos, IEEE Trans. Supercond., Vol. 9, Issue 2, June 1999, p. 213 – 215.

D.R. Chichili, et al., IEEE Trans. Supercond., Vol. 10, Issue 1, March 2000, p. 1317 – 1320.

Final summary

- A deep knowledge of mechanics **basic concepts** is essential.
- The mechanical designer of superconducting magnets should **avoid tensile stresses** in the coils and the mechanical degradation of materials.
- **Pre-compression** is the classical way to avoid tensile stresses on the coils when energizing a superconducting magnet.
- **Numerical methods** provide better modeling, but **analytical approach** is very valuable.
- Magnets are providing higher and higher fields: Lorentz forces are proportional to the **squared field**.
- **There is not a unique solution for every magnet.**
- **Final remark:** we must be creative, but one should always review the previous experience, it is not necessary to reinvent the wheel.

Thank you for your attention!





Appendices



All the Appendices are taken from Unit 10, USPAS course on Superconducting Accelerator Magnets, 2012 (P. Ferracin et al.)



Appendix I

Thin shell approximation





Appendix I: thin shell approximation

Field and forces: general case



- We assume
 - $J = J_0 \cos n\theta$ where J_0 [A/m] is \perp to the cross-section plane
 - Radius of the shell/coil = a
 - No iron

- The field inside the aperture is

$$B_{ri} = -\frac{\mu_0 J_0}{2} \left(\frac{r}{a}\right)^{n-1} \sin n\mathcal{G} \quad B_{\theta i} = -\frac{\mu_0 J_0}{2} \left(\frac{r}{a}\right)^{n-1} \cos n\mathcal{G}$$

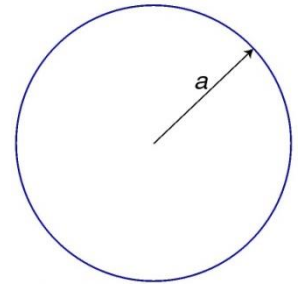

- The average field in the coil is

$$B_r = -\frac{\mu_0 J_0}{2} \sin n\mathcal{G} \quad B_\theta = 0$$

- The Lorentz force acting on the coil [N/m²] is

$$f_r = -B_\theta J = 0 \quad f_\theta = B_r J = -\frac{\mu_0 J_0}{2} \sin n\mathcal{G} \cos n\theta$$

$$f_x = f_r \cos \theta - f_\theta \sin \theta \quad f_y = f_r \sin \theta + f_\theta \cos \theta$$

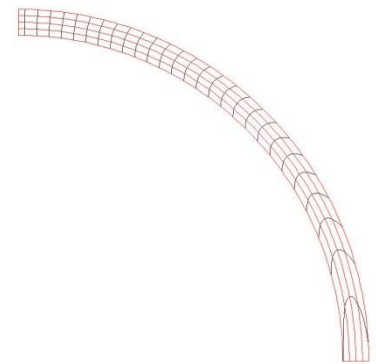



Appendix I: thin shell approximation

Field and forces: dipole

- In a dipole, the field inside the coil is

$$B_y = -\frac{\mu_0 J_0}{2}$$

- The total force acting on the coil [N/m] is

$$F_x = \frac{B_y^2}{2\mu_0} \frac{4}{3} a \quad F_y = -\frac{B_y^2}{2\mu_0} \frac{4}{3} a$$

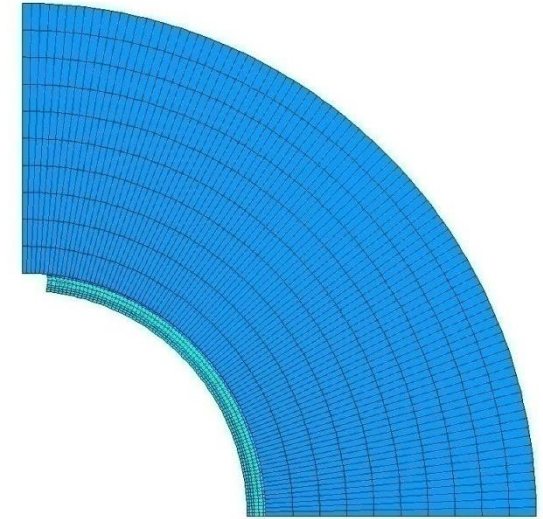

- The Lorentz force on a dipole coil varies
 - with the square of the bore field
 - linearly with the magnetic pressure
 - linearly with the bore radius.
- In a rigid structure, the force determines an azimuthal displacement of the coil and creates a separation at the pole.
- The structure sees F_x .



Appendix I: thin shell approximation

Field and forces: quadrupole



- In a quadrupole, the gradient [T/m] inside the coil is

$$G = \frac{B_c}{a} = -\frac{\mu_0 J_0}{2a}$$

- The total force acting on the coil [N/m] is

$$F_x = \frac{B_c^2}{2\mu_0} a \frac{4\sqrt{2}}{15} = \frac{G^2}{2\mu_0} a^3 \frac{4\sqrt{2}}{15}$$

$$F_y = -\frac{B_c^2}{2\mu_0} a \frac{4\sqrt{2} + 8}{15} = -\frac{G^2}{2\mu_0} a^3 \frac{4\sqrt{2} + 8}{15}$$

- The Lorentz force on a quadrupole coil varies
 - with the square of the gradient or coil peak field
 - with the cube of the aperture radius (for a fixed gradient).
- Keeping the peak field constant, the force is proportional to the aperture.

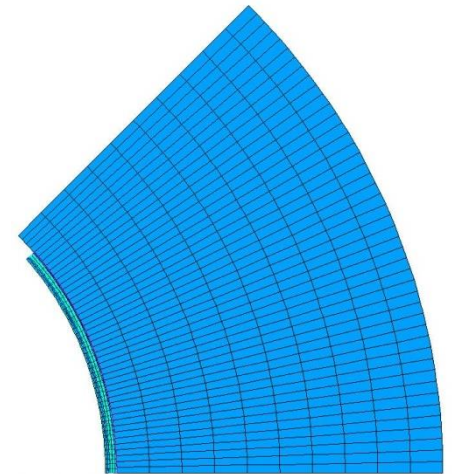



Appendix I: thin shell approximation

Stored energy and end forces: dipole and quadrupole

- For a dipole, the vector potential within the thin shell is

$$A_z = + \frac{\mu_0 J_0}{2} a \cos \vartheta$$

and, therefore,

$$F_z = \frac{B_y^2}{2\mu_0} 2\pi a^2$$

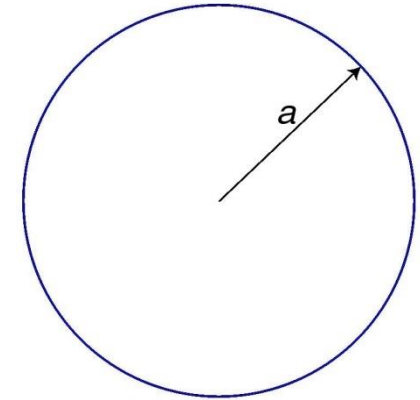

- The axial force on a dipole coil varies
 - with the square of the bore field
 - linearly with the magnetic pressure
 - with the square of the bore radius.
- For a quadrupole, the vector potential within the thin shell is

$$A_z = + \frac{\mu_0 J_0}{2} \frac{a}{2} \cos 2\vartheta$$

and, therefore,

$$F_z = \frac{B_c^2}{2\mu_0} \pi a^2 = \frac{G^2 a^2}{2\mu_0} \pi a^2$$

- Being the peak field the same, a quadrupole has half the F_z of a dipole.



Appendix I: thin shell approximation

Total force on the mid-plane: dipole and quadrupole



- If we assume a “roman arch” condition, where all the f_θ accumulates on the mid-plane, we can compute a total force transmitted on the mid-plane F_θ [N/m]

- For a dipole,

$$F_\theta = \int_0^{\pi/2} f_\theta a d\theta = -\frac{B_y^2}{2\mu_0} 2a$$

- For a quadrupole,

$$F_\theta = \int_0^{\pi/4} f_\theta a d\theta = -\frac{B_c^2}{2\mu_0} a = -\frac{G^2}{2\mu_0} a^3$$

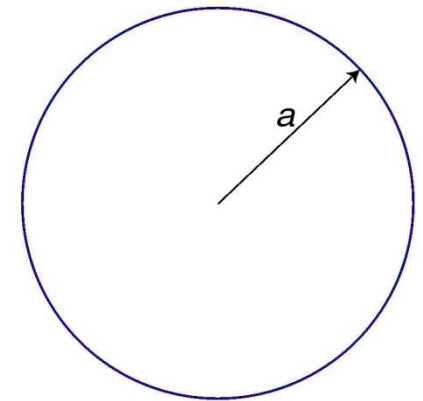

- Being the peak field the same, a quadrupole has half the F_θ of a dipole.
- Keeping the peak field constant, the force is proportional to the aperture.



Appendix II

Thick shell approximation





Appendix II: thick shell approximation

Field and forces: general case



- We assume
 - $J = J_0 \cos n\theta$ where J_0 [A/m²] is \perp to the cross-section plane
 - Inner (outer) radius of the coils = a_1 (a_2)
 - No iron
- The field inside the aperture is

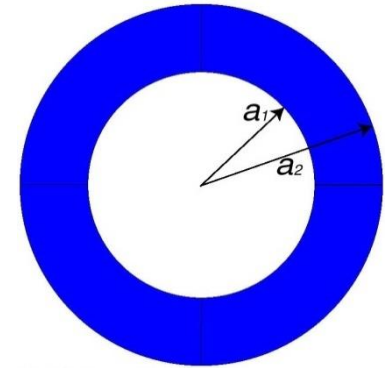

$$B_{ri} = -\frac{\mu_0 J_0}{2} r^{n-1} \left(\frac{a_2^{2-n} - a_1^{2-n}}{2-n} \right) \sin n\vartheta \quad B_{\theta i} = -\frac{\mu_0 J_0}{2} r^{n-1} \left(\frac{a_2^{2-n} - a_1^{2-n}}{2-n} \right) \cos n\vartheta$$

- The field in the coil is

$$B_r = -\frac{\mu_0 J_0}{2} \left[r^{n-1} \left(\frac{a_2^{2-n} - r^{2-n}}{2-n} \right) + \frac{1}{2+n} \left(\frac{r^{2+n} - a_1^{2+n}}{r^{1+n}} \right) \right] \sin n\vartheta \quad B_{\theta} = -\frac{\mu_0 J_0}{2} \left[r^{n-1} \left(\frac{a_2^{2-n} - r^{2-n}}{2-n} \right) - \frac{1}{2+n} \left(\frac{r^{2+n} - a_1^{2+n}}{r^{1+n}} \right) \right] \cos n\vartheta$$

- The Lorentz force acting on the coil [N/m³] is

$$f_r = -B_{\theta} J = \frac{\mu_0 J_0^2}{2} \left[r^{n-1} \left(\frac{a_2^{2-n} - r^{2-n}}{2-n} \right) - \frac{1}{2+n} \left(\frac{r^{2+n} - a_1^{2+n}}{r^{1+n}} \right) \right] \cos^2 n\vartheta \quad f_x = f_r \cos\theta - f_{\theta} \sin\theta$$

$$f_{\theta} = B_r J = -\frac{\mu_0 J_0^2}{2} \left[r^{n-1} \left(\frac{a_2^{2-n} - r^{2-n}}{2-n} \right) + \frac{1}{2+n} \left(\frac{r^{2+n} - a_1^{2+n}}{r^{1+n}} \right) \right] \sin n\theta \cos n\vartheta \quad f_y = f_r \sin\theta + f_{\theta} \cos\theta$$



Appendix II: thick shell approximation

Field and forces: dipole



- In a dipole, the field inside the coil is

$$B_y = -\frac{\mu_0 J_0}{2} (a_2 - a_1)$$

- The total force acting on the coil [N/m] is

$$F_x = \frac{\mu_0 J_0^2}{2} \left[\frac{7}{54} a_2^3 + \frac{1}{9} \left(\ln \frac{a_2}{a_1} + \frac{10}{3} \right) a_1^3 - \frac{1}{2} a_2 a_1^2 \right]$$

$$F_y = -\frac{\mu_0 J_0^2}{2} \left[\frac{2}{27} a_2^3 + \frac{2}{9} \left(\ln \frac{a_1}{a_2} - \frac{1}{3} \right) a_1^3 \right]$$

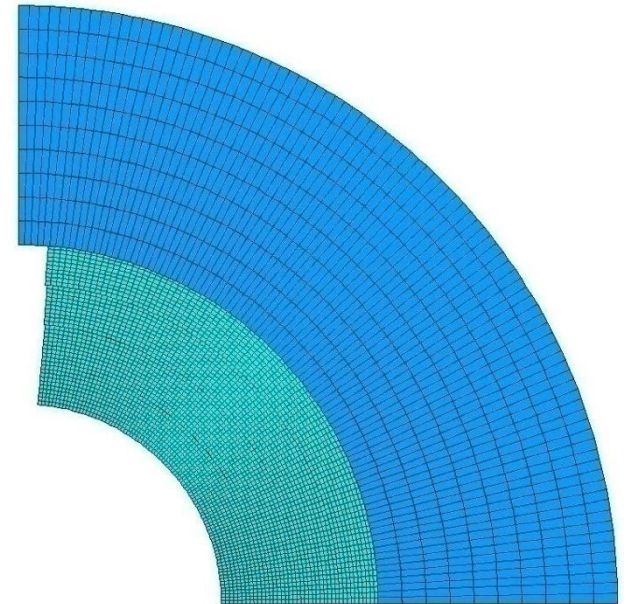



Appendix II: thick shell approximation

Field and forces: quadrupole



- In a quadrupole, the field inside the coil is

$$G = \frac{B_y}{r} = -\frac{\mu_0 J_0}{2} \ln \frac{a_2}{a_1} \quad \text{being} \quad \frac{a_2^{2-n} - a_1^{2-n}}{2-n} = \ln \frac{a_2}{a_1}$$

- The total force acting on the coil [N/m] is

$$F_x = \frac{\mu_0 J_0^2}{2} \left[\frac{\sqrt{2}}{540} \frac{11a_2^4 - 27a_1^4}{a_2} + \frac{5\sqrt{2}}{45} \left(\ln \frac{a_1}{a_2} + \frac{4}{15} \right) a_1^3 \right]$$

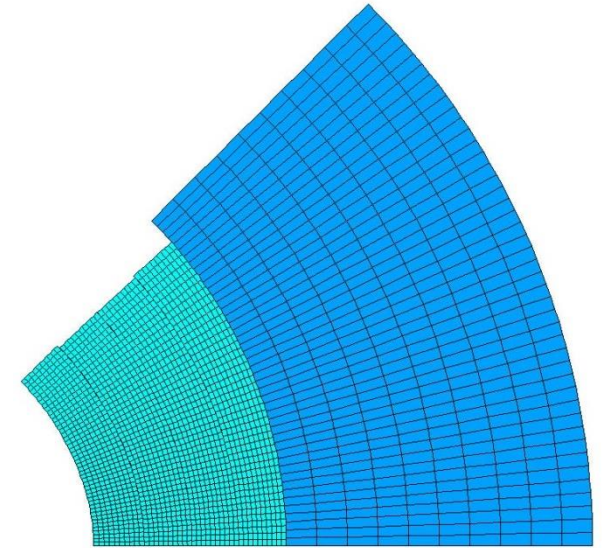

$$F_y = -\frac{\mu_0 J_0^2}{2} \left\{ \frac{1}{540} \frac{(11\sqrt{2} + 7)a_2^4 + (81 - 27\sqrt{2})a_1^4}{a_2} + \frac{1}{45} \left[(5\sqrt{2} - 5) \ln \frac{a_1}{a_2} + \frac{4\sqrt{2} - 22}{3} \right] a_1^3 \right\}$$



Appendix II: thick shell approximation

Stored energy, end forces: dipole and quadrupole

- For a dipole,

$$A_z = + \frac{\mu_0 J_0}{2} r \left[(a_2 - r) - \frac{r^3 - a_1^3}{3r^2} \right] \cos \theta$$

and, therefore,

$$F_z = + \frac{\mu_0 J_0^2}{2} \frac{\pi}{2} \left(\frac{a_2^4}{6} - \frac{2}{3} a_1^3 a_2 + \frac{a_1^4}{2} \right)$$

- For a quadrupole,

$$A_z = + \frac{\mu_0 J_0}{2} \frac{r}{2} \left(r \ln \frac{a_2}{r} - \frac{r^4 - a_1^4}{4r^3} \right) \cos 2\theta$$

and, therefore,

$$F_z = + \frac{\mu_0 J_0^2}{2} \frac{\pi}{8} \left[\frac{a_2^4}{8} + \left(\ln \frac{a_1}{a_2} - \frac{1}{4} \right) a_1^4 \right]$$

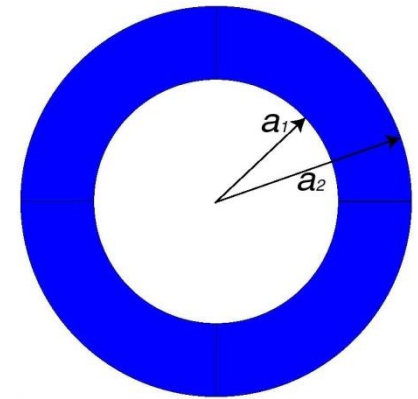



Appendix II: thick shell approximation

Stress on the mid-plane: dipole and quadrupole

- For a dipole,

$$\sigma_{\theta_mid-plane} = \int_0^{\pi/2} f_{\theta} r d\theta = -\frac{\mu_0 J_0^2}{2} \frac{r}{2} \left[(a_2 - r) + \frac{r^3 - a_1^3}{3r^2} \right]$$

No shear

$$\sigma_{\theta_mid-plane_av} = -\frac{\mu_0 J_0^2}{2} \left[\frac{5}{36} a_2^3 + \frac{1}{6} \left(\ln \frac{a_1}{a_2} + \frac{2}{3} \right) a_1^3 - \frac{1}{4} a_2 a_1^2 \right] \frac{1}{a_2 - a_1}$$

- For a quadrupole,

$$\sigma_{\theta_mid-plane} = \int_0^{\pi/4} f_{\theta} r d\theta = -\frac{\mu_0 J_0^2}{2} \frac{r}{4} \left(r \ln \frac{a_2}{r} + \frac{r^4 - a_1^4}{4r^3} \right)$$

$$\sigma_{\theta_mid-plane_av} = -\frac{\mu_0 J_0^2}{2} \left[\frac{1}{144} \frac{7a_2^4 + 9a_1^4}{a_2} + \frac{1}{12} \left(\ln \frac{a_1}{a_2} + \frac{4}{3} \right) a_1^3 \right] \frac{1}{a_2 - a_1}$$

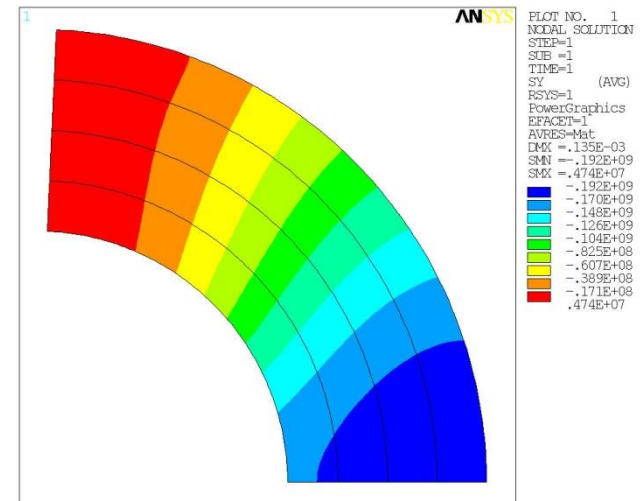
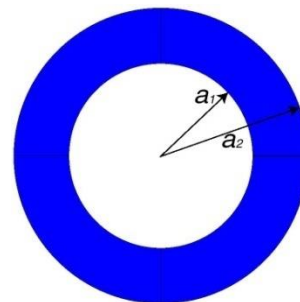
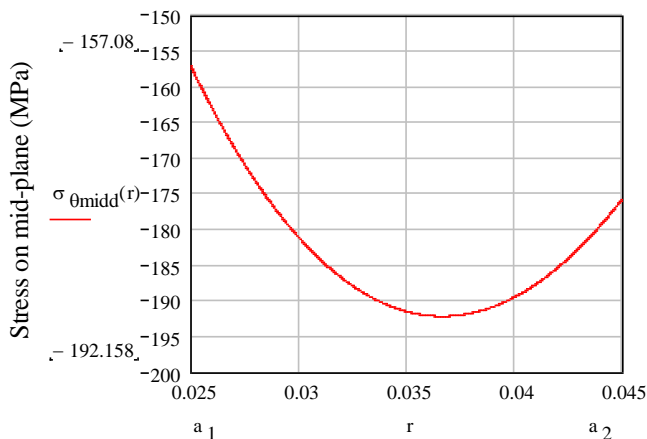



Appendix III

Sector approximation





Appendix III: sector approximation

Field and forces: dipole



- We assume
 - $J=J_0$ is \perp the cross-section plane
 - Inner (outer) radius of the coils = a_1 (a_2)
 - Angle $\phi = 60^\circ$ (third harmonic term is null)
 - No iron
- The field inside the aperture

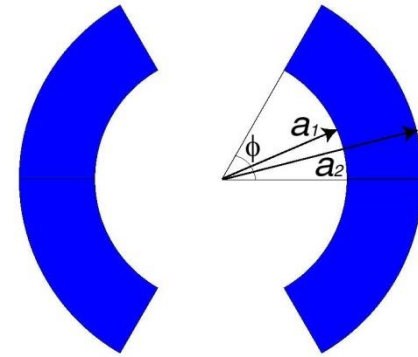

$$B_r = -\frac{2\mu_0 J_0}{\pi} \left[(a_2 - a_1) \sin \phi \sin \theta + \sum_{n=1}^{\infty} \frac{r^{2n}}{(2n+1)(2n-1)} \left(\frac{1}{a_1^{n-1}} - \frac{1}{a_2^{n-1}} \right) \sin(2n+1)\phi \sin(2n+1)\theta \right]$$

$$B_\theta = -\frac{2\mu_0 J_0}{\pi} \left[(a_2 - a_1) \sin \phi \cos \theta + \sum_{n=1}^{\infty} \frac{r^{2n}}{(2n+1)(2n-1)} \left(\frac{1}{a_1^{n-1}} - \frac{1}{a_2^{n-1}} \right) \sin(2n+1)\phi \cos(2n+1)\theta \right]$$

- The field in the coil is

$$B_r = -\frac{2\mu_0 J_0}{\pi} \left\{ (a_2 - r) \sin \phi \sin \theta + \sum_{n=1}^{\infty} \left[1 - \left(\frac{a_1}{r} \right)^{2n+1} \right] \frac{r}{(2n+1)(2n-1)} \sin(2n-1)\phi \sin(2n-1)\theta \right\}$$

$$B_\theta = -\frac{2\mu_0 J_0}{\pi} \left\{ (a_2 - r) \sin \phi \cos \theta - \sum_{n=1}^{\infty} \left[1 - \left(\frac{a_1}{r} \right)^{2n+1} \right] \frac{r}{(2n+1)(2n-1)} \sin(2n-1)\phi \cos(2n-1)\theta \right\}$$



Appendix III: sector approximation

Field and forces: dipole



- The Lorentz force acting on the coil [N/m³], considering the basic term, is

$$f_r = -B_\theta J = +\frac{2\mu_0 J_0^2}{\pi} \sin \phi \left[(a_2 - r) - \frac{r^3 - a_1^3}{3r^2} \right] \cos \theta \quad f_x = f_r \cos \theta - f_\theta \sin \theta$$

$$f_\theta = B_r J = -\frac{2\mu_0 J_0^2}{\pi} \sin \phi \left[(a_2 - r) + \frac{r^3 - a_1^3}{3r^2} \right] \sin \theta \quad f_y = f_r \sin \theta + f_\theta \cos \theta$$

- The total force acting on the coil [N/m] is

$$F_x = +\frac{2\mu_0 J_0^2}{\pi} \frac{\sqrt{3}}{2} \left[\frac{2\pi - \sqrt{3}}{36} a_2^3 + \frac{\sqrt{3}}{12} \ln \frac{a_2}{a_1} a_1^3 + \frac{4\pi + \sqrt{3}}{36} a_1^3 - \frac{\pi}{6} a_2 a_1^2 \right]$$

$$F_y = -\frac{2\mu_0 J_0^2}{\pi} \frac{\sqrt{3}}{2} \left[\frac{1}{12} a_2^3 + \frac{1}{4} \ln \frac{a_1}{a_2} a_1^3 - \frac{1}{12} a_1^3 \right]$$

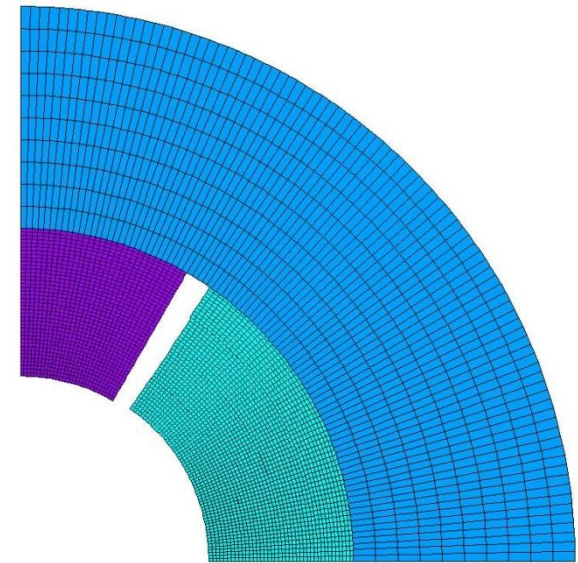



Appendix III: sector approximation

Field and forces: quadrupole



- We assume
 - $J=J_0$ is \perp the cross-section plane
 - Inner (outer) radius of the coils = a_1 (a_2)
 - Angle $\phi = 30^\circ$ (third harmonic term is null)
 - No iron
- The field inside the aperture

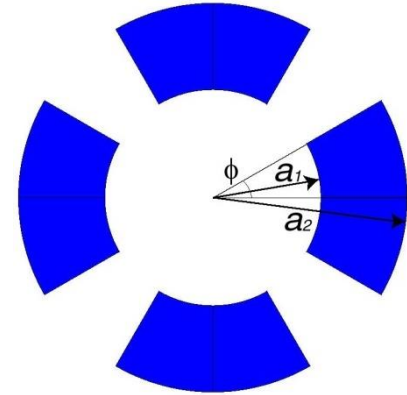

$$B_r = -\frac{2\mu_0 J_0}{\pi} \left\{ r \ln \frac{a_2}{a_1} \sin 2\phi \sin 2\theta + \sum_{n=1}^{\infty} \frac{r}{2n(4n+2)} \left[\left(\frac{r}{a_1} \right)^{4n} - \left(\frac{r}{a_2} \right)^{4n} \right] \sin(4n+2)\phi \sin(4n+2)\theta \right\}$$

$$B_\theta = -\frac{2\mu_0 J_0}{\pi} \left\{ r \ln \frac{a_2}{a_1} \sin 2\phi \cos 2\theta + \sum_{n=1}^{\infty} \frac{r}{2n(4n+2)} \left[\left(\frac{r}{a_1} \right)^{4n} - \left(\frac{r}{a_2} \right)^{4n} \right] \sin(4n+2)\phi \cos(4n+2)\theta \right\}$$

- The field in the coil is

$$B_r = -\frac{2\mu_0 J_0}{\pi} \left\{ r \ln \frac{a_2}{r} \sin 2\phi \sin 2\theta + \sum_{n=1}^{\infty} \frac{r}{2n(4n-2)} \left[1 - \left(\frac{a_1}{r} \right)^4 \right] \sin(4n-2)\phi \sin(4n-2)\theta \right\}$$

$$B_\theta = -\frac{2\mu_0 J_0}{\pi} \left\{ r \ln \frac{a_2}{r} \sin 2\phi \cos 2\theta - \sum_{n=1}^{\infty} \frac{r}{2n(4n-2)} \left[1 - \left(\frac{a_1}{r} \right)^4 \right] \sin(4n-2)\phi \cos(4n-2)\theta \right\}$$



Appendix III: sector approximation

Field and forces: quadrupole



- The Lorentz force acting on the coil [N/m³], considering the basic term, is

$$f_r = -B_\theta J = + \frac{2\mu_0 J_0^2}{\pi} \sin 2\phi \left(r \ln \frac{a_2}{r} - \frac{r^4 - a_1^4}{4r^3} \right) \cos 2\theta \quad f_x = f_r \cos \theta - f_\theta \sin \theta$$

$$f_\theta = B_r J = - \frac{2\mu_0 J_0^2}{\pi} \sin 2\phi \left(r \ln \frac{a_2}{r} + \frac{r^4 - a_1^4}{4r^3} \right) \sin 2\theta \quad f_y = f_r \sin \theta + f_\theta \cos \theta$$

- The total force acting on the coil [N/m] is

$$F_x = + \frac{2\mu_0 J_0^2}{\pi} \frac{\sqrt{3}}{12} \left[\frac{1}{72} \frac{12a_2^4 - 36a_1^4}{a_2} + \left(\ln \frac{a_1}{a_2} + \frac{1}{3} \right) a_1^3 \right]$$

$$F_y = - \frac{2\mu_0 J_0^2}{\pi} \frac{\sqrt{3}}{2} \left[\frac{5 - 2\sqrt{3}}{36} a_2^3 + \frac{1}{12} \frac{a_1^4}{a_2} + \frac{2 - \sqrt{3}}{6} \ln \frac{a_1}{a_2} a_1^3 + \frac{1}{9} \left(\frac{\sqrt{3}}{2} - 2 \right) a_1^3 \right]$$

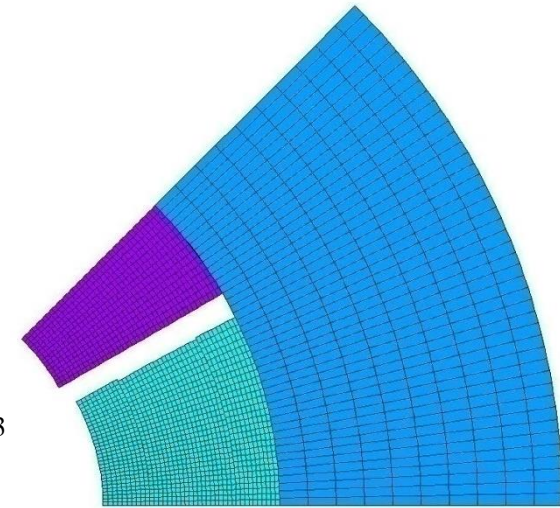



Appendix III: sector approximation

Stored energy, end forces: dipole and quadrupole



- For a dipole,

$$A_z = +\frac{2\mu_0 J_0}{\pi} r \sin \phi \left[(a_2 - r) - \frac{r^3 - a_1^3}{3r^2} \right] \cos \theta$$

and, therefore,

$$F_z = +\frac{2\mu_0 J_0^2}{\pi} \frac{3}{2} \left(\frac{a_2^4}{6} - \frac{2}{3} a^3 a_2 + \frac{a_1^4}{2} \right)$$

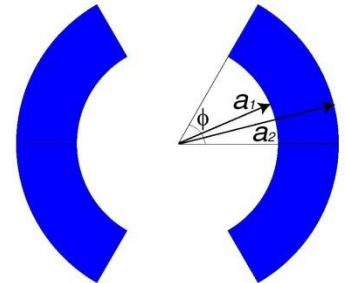

- For a quadrupole,

$$A_z = +\frac{2\mu_0 J_0}{\pi} \frac{r}{2} \sin 2\phi \left(r \ln \frac{a_2}{r} - \frac{r^4 - a_1^4}{4r^3} \right) \cos 2\theta$$

and, therefore,

$$F_z = +\frac{2\mu_0 J_0^2}{\pi} \frac{3}{8} \left[\frac{a_2^4}{8} + \left(\ln \frac{a_1}{a_2} - \frac{1}{4} \right) a_1^4 \right]$$

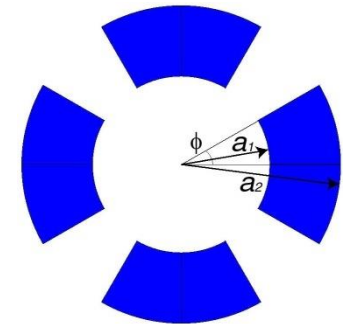



Appendix III: sector approximation

Stress on the mid-plane: dipole and quadrupole

- For a dipole,

$$\sigma_{\theta_mid-plane} = \int_0^{\pi/3} f_{\theta} r d\theta = -\frac{2\mu_0 J_0^2}{\pi} \frac{\sqrt{3}}{4} r \left[(a_2 - r) - \frac{r^3 - a_1^3}{3r^2} \right]$$

No shear

$$\sigma_{\theta_mid-plane_av} = -\frac{2\mu_0 J_0^2}{\pi} \frac{3}{4} \left[\frac{5}{36} a_2^3 + \frac{1}{6} \left(\ln \frac{a_1}{a_2} + \frac{2}{3} \right) a_1^3 - \frac{1}{4} a_2 a_1^2 \right] \frac{1}{a_2 - a_1}$$

- For a quadrupole,

$$\sigma_{\theta_mid-plane} = \int_0^{\pi/6} f_{\theta} r d\theta = -\frac{2\mu_0 J_0^2}{\pi} \frac{\sqrt{3}}{8} r \left(r \ln \frac{a_2}{r} + \frac{r^4 - a_1^4}{4r^3} \right)$$

$$\sigma_{\theta_mid-plane_av} = -\frac{2\mu_0 J_0^2}{\pi} \frac{\sqrt{3}}{2} \left[\frac{1}{36} \frac{7a_2^4 + 9a_1^4}{a_2} + \frac{1}{3} \left(\ln \frac{a_1}{a_2} + \frac{4}{3} \right) a_1^3 \right] \frac{1}{a_2 - a_1}$$

