

Fractional Branes and Dynamical Supersymmetry Breaking

Sebastián Franco[†], Amihay Hanany[†], Fouad Saad[‡], Angel M. Uranga[‡] *

[†] *Center for Theoretical Physics,
Massachusetts Institute of Technology,
Cambridge, MA 02139, USA.*

sfranco, hanany@mit.edu

[‡] *Instituto de Física Teórica, Facultad de Ciencias, C- XVI
Universidad Autónoma de Madrid, 28049 Madrid, Spain*

and

TH Division, CERN, CH-1211 Geneve 23, Switzerland

fouad.saad, angel.uranga@uam.es, angel.uranga@cern.ch

ABSTRACT: We study the dynamics of fractional branes at toric singularities, including cones over del Pezzo surfaces and the recently constructed $Y^{p,q}$ theories. We find that generically the field theories on such fractional branes show dynamical supersymmetry breaking, due to the appearance of non-perturbative superpotentials. In special cases, one recovers the known cases of supersymmetric infrared behaviors, associated to SYM confinement (mapped to complex deformations of the dual geometries, in the gauge/string correspondence sense) or $N = 2$ fractional branes. In the supersymmetry breaking cases, when the dynamics of closed string moduli at the singularity is included, the theories show a runaway behavior (involving moduli such as FI terms or equivalently dibaryonic operators), rather than stable non-supersymmetric minima. We comment on the implications of this gauge theory behavior for the infrared smoothing of the dual warped throat solutions with 3-form fluxes, describing duality cascades ending in such field theories. We finally provide a description of the different fractional branes in the recently introduced brane tiling configurations.

Contents

1. Introduction	2
2. Classes of fractional branes	4
3. The dP_1 case	6
3.1 Quiver theory and UV cascade	6
3.2 Dynamical supersymmetry breaking in dP_1	8
3.2.1 Field theory analysis	8
3.2.2 Analysis in a different regime	11
3.2.3 Dynamical FI terms	12
3.3 Additional D-brane probes	13
4. The SPP example	14
5. Higher del Pezzo examples	17
5.1 The dP_2 case	17
5.2 The dP_3 case	20
5.3 Beyond dP_3	23
6. The $Y^{p,q}$ family	25
7. Brane tilings and fractional branes	29
7.1 Brane tiling perspective of fractional branes	30
7.2 Beta function relations and baryonic $U(1)$ symmetries from brane tilings	35
8. Conclusions	37
A. Deformations and obstructions for isolated toric singularities	38

*Research supported in part by the CTP and the LNS of MIT and the U.S. Department of Energy under cooperative agreement #DE-FC02-94ER40818, and the CICYT, Spain. A. H. is also supported by BSF American–Israeli Bi–National Science Foundation and a DOE OJI award.

1. Introduction

D-branes at singularities provide a useful arena to study and test the gauge/string correspondence, in situations with reduced (super)symmetry. When D3-branes are located at a conical singularity, they lead to conformal field theories, described as quiver gauge theories, whose dual is provided by Type IIB theory on $AdS_5 \times X_5$ where X_5 is the base of the real cone given by the singularity.

A simple way to break conformal invariance is to introduce fractional branes at the singularity. Physically they correspond to D-branes wrapped on cycles collapsed at the singularity, consistently with cancellation of (local) RR tadpoles. At the level of the quiver, fractional branes correspond to rank assignments for nodes in the quiver, which are consistent with cancellation of non-abelian anomalies.

In the presence of a large number of D3-branes, a small amount of fractional branes leads to a controlled breaking of conformal invariance, yielding field theories with tractable supergravity duals. In many cases, the field theory RG flow is known to lead to a cascade of Seiberg dualities in which the effective number of D3-branes decreases, while that of fractional branes remains constant [1, 2, 3, 4]. Hence the infrared dynamics is dominated by the field theory on the fractional branes, in the absence of D3-branes. Hence, the exact dynamics (including non-perturbative effects) of the field theories on fractional branes is an important question. In fact, it is an interesting question even independently of whether such field theories lie at the end of duality cascades or not.

A systematic study of fractional branes, and the dynamics they trigger, for large classes of toric singularities was initiated in [4]. There, different tools were provided to identify fractional branes leading to infrared confinement, described in the supergravity dual as complex deformations of the conical geometry. A precise description of the complex deformation is obtained by using the web diagram for the singularity, dual to its toric diagram [5, 6], in terms of removal of a subweb in equilibrium. The gauge dynamics, and its dual supergravity description, is very similar to that in [1]. The cases covered by this analysis include a subset of the throat solutions studied in [2] for cones over del Pezzo surfaces, and the complex deformation provides the appropriate smoothing of the infrared singularity of these throats.

On the other hand, other choices of fractional branes do not trigger complex deformations, since they do not correspond to removal of subwebs in equilibrium. We will see that this applies to most of the fractional branes employed in the throat solutions for cones over del Pezzo surfaces [2] and cones over the $Y^{p,q}$ manifolds [3]. This nicely agrees with the fact that the field theories on the corresponding fractional branes do not show simple confinement as in the previous family. The infrared dynamics of these gauge field theories is thus

an important hint in understanding the properties of these supergravity solutions, and in particular the smoothing of their infrared naked singularities.

In this paper we address the general question of analyzing the dynamics of the gauge field theories on fractional branes. The results are very interesting. We show that generically the field theories show Dynamical Supersymmetry Breaking (DSB). The origin of DSB is an incompatibility between the fact that the branes are fractional (so that there are no classical flat directions and the classical F- and D- scalar potential forces all vevs to vanish) and the dynamical generation of a non-perturbative Affleck-Dine-Seiberg (ADS) superpotential (which pushes the meson vevs to infinity, namely repels the branes from the origin).

More precisely, once the coupling of closed string moduli to the $U(1)$ factors as Fayet-Illiopoulos (FI) terms is taken into account (equivalently, once $U(1)$'s are made massive by $B \wedge F$ couplings and disappear, thus allowing for the existence of dibaryonic operators), the theories show a runaway behavior in those directions. Hence the complete dynamics strictly correspond to a runaway situation, rather than to a stable non-supersymmetric minimum. This is similar to the discussion in an orientifold model in [7]. Concerning the supergravity duals, the gauge analysis suggests that it may be possible to construct a geometric smoothing of the naked singularities in the warped throat solutions, but it should be non-supersymmetric and presumably non-stable. Namely there does not seem to exist a stable smooth geometry whose UV asymptotics correspond to the warped throats solutions with 3-form fluxes (for choices of fluxes corresponding to DSB fractional branes).

In this paper we perform an exhaustive discussion of different kinds of fractional branes and their dynamics in several families of examples, including the suspended pinch point (SPP) singularity, cones over del Pezzo surfaces, and cones over the $Y^{p,q}$ manifolds. Many other examples, recently available using the techniques in e.g. [8] can be worked out similarly. In particular the use of brane dimers and brane tilings [9, 10] may allow to sharpen early discussions of dynamical susy breaking using brane configurations [11]. In fact, we take some steps in this direction by providing a detailed description in terms of brane tilings of fractional branes with supersymmetric infrared dynamics.

The paper is organized as follows. In section 2 we classify fractional branes in three different classes, according to the infrared dynamics they produce. They are named i) deformation branes, triggering complex deformations in the supergravity dual, ii) $N = 2$ branes, leading to $N = 2$ dynamics along its flat direction, and iii) DSB branes, whose dynamics breaks supersymmetry. In section 3 we study the simplest example of a DSB fractional brane, arising for the cone over dP_1 . We study the gauge theory on fractional branes from different viewpoints, and describe the breakdown of supersymmetry due to

non-perturbative effects. We discuss the role of closed string moduli at the singularity (equivalently of di-baryonic operators on the gauge theory), arguing that the behavior of the theory is a runaway one, and does not really have a stable non-supersymmetric minimum.

In sections 4 and 5 we carry out a similar analysis for other theories, including the SPP singularity and some examples of cones over del Pezzo surfaces. We show that combinations of different deformation and/or $N = 2$ fractional branes, which individually lead to supersymmetric infrared behavior, may lead to breakdown of supersymmetry when combined together, and present several examples of this kind. In section 6 we center on the infinite family of $Y^{p,q}$ theories, and show that the fractional brane leads to breakdown of supersymmetry in all these theories. This should have important implications for the infrared smoothing of the warped throat solutions in [3], on which we comment.

In section 7 we provide a description of fractional branes in terms of the brane dimers and brane tiling constructions recently introduced in [9, 10]. This provides a simple procedure for describing the infrared dynamics for supersymmetric branes, like the effect of infrared confinement for deformation branes. We also use these techniques to describe a subset of the baryonic $U(1)$ global symmetries of the gauge theory.

Finally, in section 8 we offer our final comments. In appendix A we review the mathematical description of complex deformations for toric singularities, and show that the cones over $Y^{p,q}$ geometries ($q \neq 0$) have first order deformations, but they are obstructed at second order.

Note: While this paper was ready for submission, we became aware of the work of [56] which has some overlap with this paper.

2. Classes of fractional branes

Fractional branes correspond to higher-dimensional D-branes wrapped over collapsed cycles in the singularity. From the point of view of the gauge theory, they correspond to anomaly free rank assignments for the quiver nodes. Hence, they are associated to vectors in the kernel of the antisymmetric intersection matrix defining the quiver. They can be classified into three groups, according to the different IR behaviors that they trigger (see Section 7 for a description of the different fractional branes using brane tilings).

$N = 2$ fractional branes: The field theory on these fractional branes has flat directions along which the dynamics generically reduces to an $N = 2$ theory. The simplest examples are provided by fractional branes whose quiver (i.e. the quiver in the absence of any other type of

fractional branes or probe D3-branes) corresponds to a closed loop of arrows passing through all nodes, with the corresponding gauge invariant polynomial not appearing in the superpotential. The vev for this operator is F-flat, and parametrizes a one-dimensional moduli space, along which the dynamics has an accidental $N = 2$ supersymmetry (8 supercharges) and in the simplest case is described by an $N = 2$ SYM theory.

Geometrically, these fractional branes appear for non-isolated singularities, which have (complex) curves of singularities passing through the origin. The fractional branes wrap the 2-cycles collapsed at the singularity, which exist at any point in the curve. For toric geometries, the singularity on the curve is always of $\mathbb{C}^2/\mathbb{Z}_N$ type. The curves of singularities are associated to the existence of points on the boundary of the toric polygon, or equivalently to parallel semi-infinite legs in the dual web diagram.

These fractional branes lead to supersymmetric infrared dynamics, which can be described in terms of the corresponding Seiberg-Witten curve. In the dual supergravity, they lead to enhançon like backgrounds [12, 13, 14, 15].

‘Deformation’ fractional branes: The corresponding quiver field theory corresponds to either a set of decoupled nodes (only gauge groups and no bifundamental fields), or to a closed loop of arrows with the corresponding gauge invariant appearing in the superpotential. The theory thus does not have flat directions. The dynamics of the field theory is (possibly partial) confinement. In the supergravity dual, the geometry undergoes a complex deformation that smoothes (possibly partially) the conical geometry. In terms of the web diagram, the complex deformation corresponds to the removal from the diagram of a subweb in equilibrium. These fractional branes, and the corresponding complex deformation have been extensively studied in many examples in [4].

DSB fractional branes: Any other anomaly free rank assignment in the quiver seems to lead to dynamical supersymmetry breaking. The prototypical field theory for such fractional brane corresponds to a set of nodes of generically different ranks, with bifundamental matter. The non-perturbative dynamics typically contains a contribution from a node generating a non-perturbative ADS superpotential. In cases with classical flat directions, they are lifted in a runaway fashion by this superpotential. In cases without flat directions, DSB arises from an incompatibility between the ADS superpotential and the classical potential forcing all vevs to vanish (as mentioned above, one recovers runaway behavior when Fayet-Illiopoulos (FI) terms are considered dynamical, or equivalently when one eliminates the $U(1)$ factors and allows for dibaryonic operators).

An important point is that the generic fractional brane case falls in this class. More concretely, generically the combination of an $N = 2$ fractional brane with a deformation fractional brane is a DSB combination. Also, in general the combination of two deformation fractional branes, for different and incompatible deformations, is also a DSB fractional brane.

Our main interest in this paper is the infrared dynamics of these fractional branes. We hope that the gauge theory results provide useful information to describe the IR completion of the supergravity dual throat solutions with fluxes.

3. The dP_1 case

The dP_1 theory provides the simplest example of a duality cascade with fractional branes, where the infrared behavior is not described by confinement/complex deformation (or by $N = 2$ like dynamics). Namely, from the web diagram in figure 1, there is no possibility of splitting a subweb in equilibrium [4], hence there are no complex deformations of this geometry. Naively this seems in contradiction with the recent results in [16], where a first order deformation of the throat solution with fluxes for the $Y^{p,q}$ geometries (and hence for the cone over dP_1 which corresponds to the $Y^{2,1}$ theory) was explicitly constructed. However, as described in [17] (see also appendix A), the cone over dP_1 precisely has an obstructed deformation, namely a first order deformation, which is obstructed at second order. Hence this result nicely reconciles both statements, and confirms that a smoothing of the infrared singularity by a complex deformation is not possible.

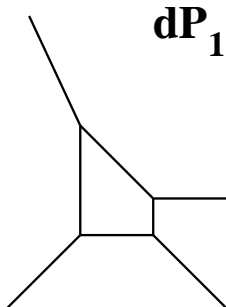

Figure 1: Web diagram for the cone over dP_1

In this section we study the dP_1 gauge theory in detail, describing our proposal for the IR behavior.

3.1 Quiver theory and UV cascade

Let us consider the cone over dP_1 geometry. The quiver field theory on D3-branes at this

singularity has been constructed in [18]. Diverse aspects of this theory have been studied in [19, 20, 21, 22, 23, 24, 25, 26, 4]

Out of the different Seiberg dual theories corresponding to this geometry, we focus on the phase with quiver diagram shown in Figure 2 and superpotential

$$W = \epsilon_{\alpha\beta} X_{23}^\alpha X_{34}^\beta X_{42} + \epsilon_{\alpha\beta} X_{34}^\alpha X_{41}^\beta X_{13} - \epsilon_{\alpha\beta} X_{12} X_{23}^\alpha X_{34}^\beta X_{41} \quad (3.1)$$

where α, β take values in 1, 2 and label a doublet representation of $SU(2)$. Also, subindices indicate the bifundamental representation under the corresponding nodes. The web diagram is shown in figure 1.

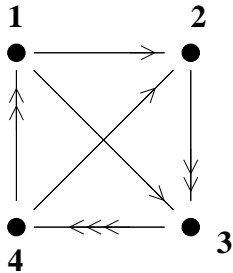

Figure 2: Quiver diagram for the dP_1 theory

There is only one kind of fractional brane², corresponding to the rank vector $(0, 3, 1, 2)$. As we explained above, this can be determined by looking at anomaly free rank assignments for the gauge groups. Starting with ranks $(N, N + 3M, N + M, N + 2M)$, this fractional brane triggers a duality cascade proposed in [2] and verified in [3, 4]. Along the cascade, the effective number of D3-branes decreases, while the number of fractional branes remains constant. Hence, for suitable UV choice of the number of D3-branes N , the infrared limit of the cascade is expected to be described by the theory in figure 3, in which the smallest rank node has reached zero rank and disappeared from the quiver.

Notice that this gauge theory does not correspond to the quiver of a deformation brane, as described in section 2. For instance, it does not correspond to a set of decoupled $SU(M)$ SYM theories without matter, as it happens in the absence of D3-branes in the theories studied in [4]. The quiver in figure 3 should be contrasted with what happens for example in the well studied example of the conifold, where there are no bifundamental fields unless D3-branes are included. Hence, we expect a behavior which is qualitatively different from that of

²For a web diagram with n external legs the number of fractional branes is $n - 3$. See [8] for a discussion on this point and a comparison to the parameters of the corresponding 5-dimensional theory [5]. A discussion of this point from a geometric viewpoint was recently done in [27].

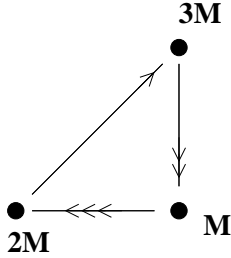

Figure 3: The theory at the end of the duality cascade triggered by M fractional branes. Here labels indicate ranks for the node gauge factors.

the conifold [1]. Indeed, this is also supported by the geometric side, since the web diagram in figure 1 does not admit a recombination of external legs into a subweb in equilibrium [4]. Namely, the cone over dP_1 does not admit a complex deformation or extremal transition in which 2- and 4-cycles disappear and 3-cycles grow [17].

It is an interesting question to find the field theory dynamics which dominates the infrared limit of this cascade, and its corresponding gravity dual. In the coming sections we carry out a simple field theory analysis to argue that the answer is dynamical supersymmetry breaking.

3.2 Dynamical supersymmetry breaking in dP_1

3.2.1 Field theory analysis

The dynamics of the infrared limit of the cascade is controlled by the quiver theory of figure 3. It corresponds to considering M fractional D-branes, without any D3-branes, $N = 0$. It leads to a theory with gauge group $SU(3M)_2 \times SU(M)_3 \times SU(2M)_4$, with fields X_{42} , $X_{23} = X_{23}^1$, $Y_{23} = X_{23}^2$, $X_{34} = X_{34}^1$, $Y_{34} = X_{34}^2$, $Z_{34} = X_{34}^3$ (were we have simplified notation with respect to that of equation (3.1).), and superpotential

$$W = X_{42}X_{23}Y_{34} - X_{42}Y_{23}X_{34}. \quad (3.2)$$

There are several ways to support the idea of the onset of dynamical supersymmetry breaking in this theory, by using several standard criteria (see [28] for a very complete introduction to DSB). One of the simplest ways is as follows: Consider a theory without classical flat directions, and such that the classical D- and F-term constraints force all vevs of the theory to vanish. In such a situation, if one of the gauge factors of the theory has $N_f < N_c$, then the non-perturbative Affleck-Dine-Seiberg superpotential for its mesons diverges at the origin, and pushes the corresponding vevs towards infinity. The theory breaks supersymmetry due to the impossibility to satisfy all F- and D-term constraints,

coming from classical and quantum contributions. The combination of the classical and the non-perturbative superpotential lead to a scalar potential with a minimum at non-zero energy. We will apply this idea to various gauge theories along this paper. We now proceed to a detailed application to the dP_1 case.

Furthermore, based on the physical interpretation of fractional branes, it is easy to realize that the above theory does not have flat directions (since they would correspond to removal of the branes out of the singularity, which is not possible for fractional branes). This can also be directly recovered from the field theory analysis, by looking for D- and F-flat directions. However, a crucial issue in getting the correct result is the following. The string theory construction leads to a gauge group $U(3M) \times U(M) \times U(2M)$. The three $U(1)$ factors in this gauge group have $B \wedge F$ couplings to 2-forms which are localized at the singularity (these arise from reduction of the RR 6- and 4-form on the 4- and the two 2-cycles on the cone over dP_1). These couplings (which are crucial in the Green-Schwarz cancellation of mixed anomalies, as in [29]) make the $U(1)$'s massive, so that they are not present at low energies. On the other hand, the D-term constraints with respect to these $U(1)$'s remain, and have to be taken into account in order to derive the correct moduli space. Notice that this is implicit in the familiar statement (implied by supersymmetry) that the NSNS partners of the above RR fields couple to the D-branes as Fayet-Illiopoulos terms [30, 31, 32].

We thus parametrize D-flat directions by operators invariant under the $SU(3M) \times SU(M) \times SU(2M)$ gauge symmetry. There are 6 such operators,

$$\begin{aligned} X_{42}X_{23}X_{34}, & \quad X_{42}X_{23}Y_{34}, & \quad X_{42}X_{23}Z_{34}, \\ X_{42}Y_{23}X_{34}, & \quad X_{42}Y_{23}Y_{34}, & \quad X_{42}Y_{23}Z_{34}. \end{aligned} \tag{3.3}$$

In order to impose F-flatness, we use e.g. the equations of motion

$$\frac{\partial W}{\partial Y_{34}} = X_{42}X_{23} = 0 \quad , \quad \frac{\partial W}{\partial X_{34}} = X_{42}Y_{23} = 0 \tag{3.4}$$

so that all operators are forced to vanish, and the origin is the only supersymmetric point. The classical superpotential thus lifts all flat directions.

It is now easy to argue that this theory breaks supersymmetry. Consider the regime where the $SU(3M)$ gauge factor dominates the dynamics. Since $SU(3M)$ has $2M$ flavors, we have $N_f < N_c$ for this theory, and it generates a non-perturbative Affleck-Dine-Seiberg superpotential which pushes the vevs for the $SU(3M)$ mesons $X_{42}X_{23}$ and $X_{42}Y_{23}$ away from zero. Combining this with the classical superpotential, we conclude that supersymmetry is broken. A more detailed analysis is presented below, in a slightly different limit.

An independent argument for DSB in this theory follows from the following alternative criterion. In a theory with no classical flat directions and with some spontaneously broken global symmetry, supersymmetry breaking occurs (see e.g. [28]). The argument is that the complex scalar in the Goldstone supermultiplet would parametrize a non-compact flat direction, which would reach the semiclassical regime, in contradiction with the absence of classical flat directions. With supersymmetry breaking, the Goldstone boson still parametrizes a compact flat direction, but the non-compact direction associated to its partner is lifted. In our case, the theory originally has a global $SU(2)$ symmetry, under which the $SU(3M)$ mesons $X_{42}X_{23}$ and $X_{42}Y_{23}$ transform in the spin-1/2 representation. The global $SU(2)$ is thus spontaneously broken by the meson vevs triggered by the ADS superpotential. Hence the criterion for DSB is satisfied.

The physical realization of the gauge field theory in terms of fractional D-branes makes also clear that there should exist a non-supersymmetric minimum at finite distance in field space, since the scalar potential grows both for large and small vevs. By considering the regime where the ADS superpotential is dominant over the classical one, one could make the minimum lie in the semiclassical region, so that a perturbative analysis would be possible. However, it is not clear that the fractional brane system has a tunable parameter that allows to consider this limit.

In any event, some qualitative features of the remaining theory at the minimum can be suggested. By taking the most symmetric choice of $SU(3M)$ meson vevs $\mathcal{M} = \mathbf{1}$, the gauge symmetry $SU(2M) \times SU(M)$ is broken to just $SU(M)$, the diagonal subgroup of $SU(M) \times SU(M) \times SU(M) \subset SU(2M) \times SU(M)$. In addition, the superpotential makes the mesons massive together with the X_{34} and Y_{34} fields. Hence at the minimum we have an $SU(M)$ theory with some adjoint matter (coming e.g. from the Z_{34} fields). A more detailed description of the minimum is also possible in other regimes, e.g. when the $SU(2M)$ dynamics dominates (see below).

Notice that the above discussion is similar to the original analysis of the $(3, 2)$ model in [33]. In fact, for a single fractional brane $M = 1$, the theory is very reminiscent of the $(3, 2)$ model. The main difference is that it contains some additional doublets, and that the flat directions are removed by a combination of F-terms and the additional $U(1)$ D-flatness conditions. Also, a similar model was studied in [11].

It is interesting to point out that the D-brane realization of this system provides a representation of the non-perturbative effect leading to the ADS superpotential. The non-perturbative effect is generated by euclidean D1-branes wrapped on the 2-cycle associated to the fractional brane. Such D-brane instanton preserves half of the four supersymmetries of

the theory, thus has two fermion zero modes and can contribute to the superpotential of the theory. More precisely, these euclidean D-branes are fractional (where here ‘fractional’ has the same meaning as for the fractional euclidean D-branes generating the gaugino condensate in D-brane realizations of $N = 1$ SYM). Using dualities, this string theory interpretation can be related to a similar effect in [34].

3.2.2 Analysis in a different regime

The physics of the model can be analyzed also in other regimes, e.g. when the $SU(2M)$ dynamics dominates, as follows. Consider the above $SU(3M)_2 \times SU(M)_3 \times SU(2M)_4$, with weakly gauged $SU(3M) \times SU(M)$, and dynamics dominated by the $SU(2M)$ factor. We can analyze the resulting dynamics by replacing it by its Seiberg dual. The gauge group of the resulting theory is $SU(3M)_2 \times SU(M)_3 \times SU(M)_4$. The fields include the original $SU(2M)$ singlets X_{23}, Y_{23} , dual quarks $X_{24}, X_{43}, Y_{43}, Z_{43}$ and mesons $M_{32}(= X_{34}X_{42}), N_{32}(= Y_{34}X_{42}), P_{32}(= Z_{34}X_{42})$. The superpotential is

$$W = N_{32}X_{23} - M_{32}Y_{23} + X_{24}(X_{43}M_{32} + Y_{43}N_{32} + Z_{43}P_{32}) \quad (3.5)$$

The first two terms give masses to the corresponding fields. Integrating them out, we are left with a theory $SU(3M)_2 \times SU(M)_3 \times SU(M)_4$, fields $X_{24}, X_{43}, Y_{43}, Z_{43}, P_{32}$, and $W = X_{24}Z_{43}P_{32}$. The $SU(2M)$ dynamics thus preserves supersymmetry. However, dynamical supersymmetry breaking is recovered when we consider the $SU(3M)$ dynamics, which generates an ADS superpotential in a theory that does not have flat directions. Notice that it would seem that diagonal vevs e.g. for fields X_{43}, Y_{43} are flat directions, but as discussed above they do not satisfy the additional $U(1)$ D-flatness conditions.

The resulting physics is most easily analyzed in the case $M = 1$. There the $SU(3)$ theory confines, leaving the meson $M_{34} = P_{32}X_{24}$ as the only degree of freedom. The gauge group is trivial and we have a superpotential

$$W = M_{34}Z_{43} + 2 \left(\frac{\Lambda^8}{M_{34}} \right)^{1/2} \quad (3.6)$$

The theory breaks supersymmetry since the F-term constraints cannot be satisfied. There is a non-supersymmetric minimum, i.e. a minimum with non-zero energy, whose existence can be suggested as follows. The F-term scalar potential is

$$V_F = |M_{34}|^2 + \left| Z_{43} + \Lambda^4 M_{34}^{-3/2} \right|^2 \quad (3.7)$$

This contribution alone would clearly generate a runaway behavior towards $M_{34} \rightarrow 0$ and $Z_{43} = -\Lambda^4 M_{34}^{-3/2} \rightarrow \infty$, with a minimum at infinity. On the other hand, Z_{43} also appears

in the additional $U(1)$ D-term potential, of the form $V_D = |Z_{43}|^4$, which grows for large Z_{43} vevs for fixed FI parameter, becoming a ‘barrier’ that prevents Z_{43} for running away. The combination of these two contributions establishes the existence of the non-supersymmetric minimum for fixed FI terms, but a more quantitative analysis is unreliable since there is seemingly no tunable parameter which allows to make the minimum lie in the semiclassical large vev region. In the next section we discuss the effect of including the dynamics of FI terms in the analysis.

3.2.3 Dynamical FI terms

In this section we discuss an important fact that was not incorporated in the above determination of the non-trivial minimum. Namely, closed string fields at the singularity are dynamical, and couple as FI terms. Taking that into account, the relevant part of the D-term potential should be written as $V_D = (|Z_{43}|^2 - \xi)^2$. This shows that one can afford to take large vevs for Z_{43} (hence making the F-terms arbitrarily small) by simply allowing for a large FI ξ (keeping the D-terms vanishing). Namely the system relaxes to minimization of its potential by dynamically allowing the closed string modes to blow up the singularity.

An equivalent description, which phrases the discussion purely in terms of the effective low energy field theory and is perhaps more appropriate for the context of the gauge/string correspondence, is as follows. As mentioned above, the coupling of the closed string RR fields, which are localized at the singularity, to the $U(1)$ factors generate a string scale mass for the latter. As a result, the $U(1)$ gauge multiplets disappear from the low energy physics. Hence, one should allow for (di)baryonic operators in the analysis of the low energy field theory. In particular the runaway direction described above is parametrized by the dibaryon $(Z_{43})^N$ associated to Z_{43} . The relation between FI terms and dibaryons has been often discussed in the literature of brane configurations of the type considered in [35], see e.g. [36, 37].

Notice that the discussion in terms of baryons allows to identify the runaway direction even in the original description of our field theory, in section 3.2.1. Namely it corresponds to the dibaryon

$$\epsilon_{i_1 \dots i_{2M}} \epsilon_{a_1 \dots a_M} \epsilon_{b_1 \dots b_M} (Z_{34})_{i_1 a_1} \dots (Z_{34})_{i_M a_M} (Z_{34})_{i_{M+1} b_1} \dots (Z_{34})_{i_{2M} b_M} \quad (3.8)$$

Hence, we conclude that the full inclusion of localized closed string fields leads to runaway behavior in those directions. We want the reader to keep in mind that this situation will hold in subsequent examples, hence we skip the corresponding discussion and simply emphasize the different gauge theory dynamics, namely the open string sector. It would be interesting

to have a more detailed understanding of this possible runaway behavior and its implications for the dual supergravity throat solutions. The natural suggestion is that a smoothing of the infrared naked singularities exists, which breaks supersymmetry, and which involves some kind of runaway instability. Hence the gauge theory suggests that there is no stable smooth solution with asymptotics corresponding to the warped throats with 3-form fluxes corresponding to DSB fractional branes.

3.3 Additional D-brane probes

In this section we comment on the interesting question of what happens in the presence of many fractional branes and a single or a few regular D3-brane probes. The classical moduli space of this theory is the moduli space of the additional D3-brane probe(s) (while the fractional ones remain stuck at the singular point). In the gravity dual, this translates to D3-branes able to probe the warped throat solution with Imaginary Self Dual (ISD) 3-form fluxes in [3]. This study hopefully provides some information on how fractional branes have modified its infrared naked singularity.

Consider the theory with ranks $(1, 3M + 1, M + 1, 2M + 1)$. The gauge group is $U(1) \times U(3M+1) \times U(M+1) \times U(2M+1)$ and following the discussion above we omit the $U(1)$ gauge groups since they become massive, thus leaving 3 groups in the product. The bifundamental fields charged under the node with the $U(1)$ group and another of gauge groups should then be simply interpreted as fundamental flavors of the latter. The theory has a moduli space which corresponds to the position of the regular D3-brane in the cone over dP_1 . Although a complete characterization is possible, it is sufficient for our purposes to focus on a particular one-dimensional flat direction. Consider the flat direction parametrized by the vev of the gauge invariant operator $Z_{34}X_{42}Y_{23}$. Clearly, the F-term constraints imply that other gauge invariant operators (e.g. $Z_{34}X_{41}Y_{13}$) get related vevs, but this will not concern us here. What is important is that it involves a vev for at least one component, denoted ϕ in what follows, of the matrix $X_{42}Y_{23}$, which is a meson of the gauge factor $SU(3M + 1)$.

Once non-perturbative dynamics is taken into account, it is clear that the theory with the additional D3-brane probe does not have a vacuum and in particular there is a runaway behavior for ϕ . For instance, consider the regime where the $SU(3M+1)$ dynamics dominates. The $SU(3M + 1)$ gauge group has $2M + 2$ flavors, so it develops an ADS superpotential for the mesons, which pushes the determinant of the meson matrix

$$\mathcal{M} = \begin{pmatrix} X_{12}X_{23} & X_{12}Y_{23} \\ X_{42}X_{23} & X_{42}Y_{23} \end{pmatrix} \tag{3.9}$$

towards infinity.

Without loss of generality we may perform gauge rotations to make the entry ϕ be the only non-vanishing one in its row and column. In that situation (and if we focus on the situation where the mesonic matrices $X_{42}X_{23}$, $X_{12}Y_{23}$, have vanishing entries in the corresponding row, column, respectively), ϕ splits off the mesonic matrix as a decoupled block. The superpotential then shows a manifest runaway behavior for ϕ . Since ϕ is part of a D-flat direction, and is pushed to infinity by the F-term potential, we recover a runaway behavior along that classically flat direction.

Physically, the D3-brane is repelled from the origin. Translating the gauge theory statement to the dynamics of a D3-brane probe of the warped throat solution with fluxes in [3], the result shows that the D3-brane probe is repelled by the infrared resolution of the naked singularity. Interestingly, this is an independent argument that the mechanism to smooth out the singularity cannot be a complex deformation preserving the Calabi-Yau property and preserving the ISD character of the 3-form fluxes. There are general arguments that ISD 3-form fluxes on CY geometries lead to no forces on D3-brane probes [38, 39, 40, 41], in contrast with the repulsion felt by our D3-brane probe.

It would be nice to extract more information about the infrared nature of the solution from the gauge theory analysis. We leave this interesting question for future work.

Finally, we would like to mention the possibility of combining different types of fractional branes to reach new physical situations and to illustrate that in general such combinations do not lead to a simple superposition of the behaviors associated to the individual branes. Consider for instance combining a fractional brane $(0, 3, 1, 2)$ with a fractional brane $(3, 0, 2, 1)$. Although each of them independently leads to DSB as described above, their combination adds up to the rank vector $(3, 3, 3, 3)$ that corresponds to a set of D3-branes, which clearly preserves supersymmetry. In coming sections we will encounter other examples where combination of different fractional branes leads to results which are not the naive superposition of the individual behaviors.

4. The SPP example

In this section we consider fractional branes in the suspended pinch point (SPP) singularity, where a new effect takes place. In this theory, there exists two independent kinds of fractional branes which independently do not break supersymmetry. One kind leads to a duality cascade, confinement and complex deformation as studied in [4], while the other belongs to an $N = 2$ subsector, and leads to an enhançon like behavior. However, as we will discuss,

combinations of the two fractional branes may be incompatible and lead to runaway behavior (in this case even before considering localized closed string modes/baryonic directions).

Consider the theory on D3-branes at an SPP singularity, defined by $xy = zw^2$. The theory, studied in [32, 42], has a quiver shown in figure 4

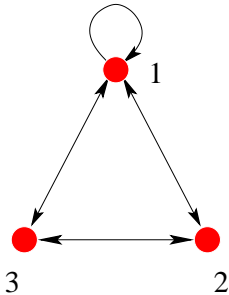

Figure 4: The quiver for the SPP theory

The superpotential is

$$W = X_{21}X_{12}X_{23}X_{32} - X_{32}X_{23}X_{31}X_{13} + X_{13}X_{31}X_{11} - X_{12}X_{21}X_{11} \quad (4.1)$$

There are two independent fractional branes, and a basis for them is provided by the rank vectors $(1, 0, 0)$ and $(0, 1, 0)$. The physics of each independent fractional brane is well-known. The $(0, 1, 0)$ triggers the complex deformation studied in [4], and shown in figure 5. The $(1, 0, 0)$ corresponds to a fractional brane of an $N = 2$ subsector. Notice that this kind of fractional brane has a modulus, parametrized by the adjoint chiral multiplet, that corresponds to sliding the fractional brane along the curve of A_1 singularities of the geometry, parametrized by z in $xy = zw^2$.

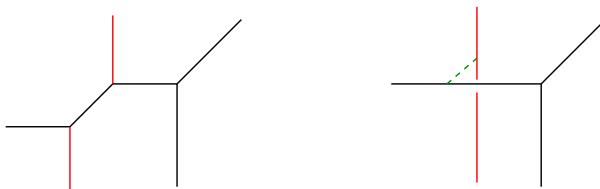

Figure 5: Complex deformation for the SPP theory

It is natural to consider what happens when both kinds of fractional branes are simultaneously present. In the following, we consider the generic case where the numbers of fractional branes are different. Geometrically, there is an incompatibility between the branes, since the $(0, 1, 0)$ triggers a complex deformation that smoothes out the space, and hence also removes the curve of A_1 singularities, i.e. the collapsed 2-cycle at the latter gets a finite size.

In that situation, the $(1, 0, 0)$ branes which are wrapped over the 2-cycle get an additional tension, and break supersymmetry. Supersymmetry would in principle be restored if the brane $(1, 0, 0)$ escapes to infinity along the curve of singularities as the complex deformation takes place. Figure 6 gives a pictorial depiction of this situation. It would be interesting to understand whether this picture goes beyond being a nice intuitive representation and we can associate to it a more quantitative geometric meaning. The discussion is similar to that in [43].

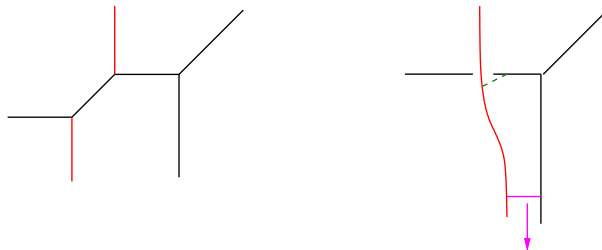

Figure 6: Web picture of the incompatibility of complex deformation and $N = 2$ fractional brane. The dashed segment represents the 3-cycle in the complex deformation, while the continuous segment represents the 2-cycle associated to the $N = 2$ brane. The picture suggests a physical interpretation of the runaway behavior of ADS superpotentials in this case: The complex deformation increases the tension of the $N = 2$ fractional brane, unless it escapes to infinity.

We may therefore expect a runaway behavior in this system. In order to verify this in detail, we take M branes of type $(1, 0, 0)$ and P branes of type $(0, 1, 0)$, and consider $P \gg M$. The dynamics is hence dominated by the $SU(P)$ theory which has M flavors and generates an ADS superpotential for the meson, which is a field ϕ in the adjoint of $SU(M)$. We obtain a superpotential

$$W = X_{11}\phi + (P - M) \left(\frac{\Lambda^{3P-M}}{\det \phi} \right)^{\frac{1}{P-M}} \quad (4.2)$$

where Φ is the original field in the adjoint of $SU(M)$. It is clear that there is no supersymmetric vacuum in this case, since F-term constraints cannot be satisfied.

It is also easy to realize that there is a runaway direction for large ϕ . In order to make it explicit, let us restrict to the simplest case of one fractional brane of type $(1, 0, 0)$ and P of type $(0, 1, 0)$. Then the gauge theory is just $SU(P)$ with one flavor, and the complete superpotential is

$$W = \phi X_{11} + (P - 1) \left(\frac{\Lambda^{3P-1}}{\phi} \right)^{\frac{1}{P-1}} \quad (4.3)$$

Notice that in this case the determinant in the ADS part is very simple, since ϕ is just a complex number. The F-terms are

$$\frac{\partial W}{\partial X_{11}} = \phi \quad , \quad \frac{\partial W}{\partial \phi} = X_{11} + \Lambda^{\frac{3P-1}{P-1}} \phi^{-\frac{P}{P-1}} \quad (4.4)$$

Clearly there is no supersymmetric vacuum. Looking for minima of the F-term scalar potential

$$V = \phi\phi^* + (X_{11} - \Lambda^{\frac{3P-1}{P-1}} \phi^{-\frac{P}{P-1}})(X_{11}^* + (\Lambda^*)^{\frac{3P-1}{P-1}} (\phi^*)^{-\frac{P}{P-1}}) \quad (4.5)$$

and upon extremization obtain

$$\begin{aligned} \frac{\partial V}{\partial X_{11}} = 0 &\rightarrow X_{11}^* + (\Lambda^*)^{\frac{3P-1}{P-1}} (\phi^*)^{-\frac{P}{P-1}} = 0 \\ \frac{\partial V}{\partial \phi} = 0 &\rightarrow \phi^* + \Lambda^{\frac{3P-1}{P-1}} \left(\frac{P}{P-1}\right) \phi^{-\frac{2P-1}{P-1}} (X_{11}^* + (\Lambda^*)^{\frac{3P-1}{P-1}} (\phi^*)^{-\frac{P}{P-1}}) = 0 \end{aligned} \quad (4.6)$$

Substituting the first equation into the second one we get $\phi^* = 0$, and then the first gives $X_{11} \rightarrow \infty$. This means that there is a runaway to a minimum at infinity in X_{11} , namely the $N = 2$ fractional brane runs to infinity. This agrees with the above physical interpretation that the fractional brane $(1, 0, 0)$ is thus pushed to infinity along this curve of singularities.

This is the first example of a situation where fractional branes which by themselves lead to $N = 1$ supersymmetric RG flows, do not have a supersymmetric vacuum when combined. Further examples will appear in subsequent sections.

5. Higher del Pezzo examples

In this section we consider other examples of fractional branes, which in principle trigger cascades which are dual to the throats in [2], but which do not fulfill the criterion in [4] to lead to a complex deformed geometry. In all cases the corresponding infrared dynamics leads to DSB.

5.1 The dP_2 case

Let us consider the cone over dP_2 . The quiver field theory has been constructed in [18]. Diverse aspects of this theory have been studied in [19, 20, 21, 22, 23, 25, 4]

The quiver for the theory is shown in figure 7, and the superpotential is

$$\begin{aligned} W = & X_{34}X_{45}X_{53} - (X_{53}Y_{31}X_{15} + X_{34}X_{42}Y_{23}) \\ & + (Y_{23}X_{31}X_{15}X_{52} + X_{42}X_{23}Y_{31}X_{14}) - X_{23}X_{31}X_{14}X_{45}X_{52} \end{aligned} \quad (5.1)$$

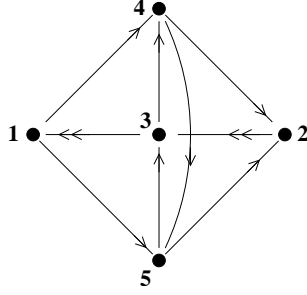

Figure 7: Quiver diagram for the dP_2 theory.



Figure 8: Web diagram for the cone over dP_2 and its deformation.

The web diagram is shown in figure 8a.

A basis of fractional branes is $(1, 1, 0, 0, 0)$ and $(1, 0, 1, 0, 2)$. The first fractional brane triggers a cascade which ends in a complex deformation, as discussed in [4] and shown in Figure 8b. The second one is also expected to trigger a duality cascade, although it has not been studied in the literature. In any event, we now focus on the field theory dynamics on a set of such fractional branes. Using the criteria in [4], the infrared dynamics does not correspond to a complex deformation.

The IR theory on M such fractional branes is given by the theory with ranks $M(1, 0, 1, 0, 2)$, shown in Figure 9b. As in the previous example, it is easy to show that the theory does not have classical flat directions, in agreement with the interpretation as a fractional brane.

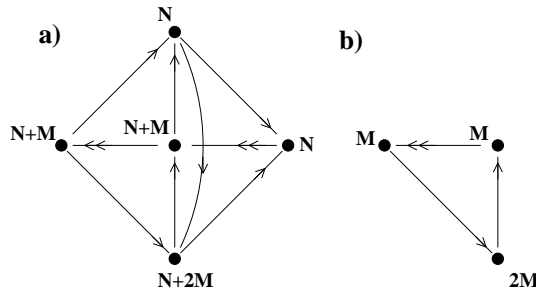

Figure 9: Quiver gauge theory for the cone over dP_2 with M fractional branes of the $(1, 0, 1, 0, 2)$ kind, with N additional D3-branes (figure a) or by themselves (figure b).

Again, it is straightforward to realize that the infrared theory has DSB. We center on the regime where the highest rank factor dominates the dynamics. The $SU(2M)$ theory has M flavors and develops an ADS superpotential. Hence the superpotential grows for large and small vevs and the theory breaks supersymmetry, with a non-supersymmetric minimum at finite distance (strictly speaking, only for an artificially fixed choice of FI terms, see section 3).

Similarly, when probed with a small number $N \ll M$ of additional regular D3-branes as in Figure 9, the latter are repelled from the tip of the throat.

Since the theory admits two different fractional branes, we can consider introducing a general linear combination of both, and consider the theory with rank vector $(N+M+P, N+M, N+P, N, N+2P)$. The analysis in [4] suggests that confinement/complex deformation occurs only for $P = 0$, and arbitrary M . The above analysis has shown DSB for $M = 0$, and arbitrary P . In what follows we consider other possibilities.

One can easily argue on general grounds that a set of fractional branes involving both kinds leads to DSB. Namely, consider the rank vector for general fractional D-branes in the absence of D3-branes, $(M+P, M, P, 0, 2P)$, with $M, P > 0$. The $SU(M+P)$ gauge factor has $2P$ flavors, hence there is an ADS superpotential (and corresponding DSB following the by now standard reasoning) for $M < P$. On the other hand, the $SU(2P)$ factor has $M+P$ flavors, hence there is an ADS superpotential triggering DSB for $P < M$. Hence the generic infrared dynamics corresponds to DSB, with cases of supersymmetric complex deformation given by the criterion in [4].

Let us consider an interesting particular limit. The simplest situation is when one of the fractional brane numbers is much larger than the other. For instance, we can consider large M and $P = 1$. In this situation, we expect the additional fractional D-brane of the second kind to behave as a probe in the complex deformed throat created by the fractional branes of the first kind. The infrared theory is shown in Figure 10.c. Notice that as in previous sections the $U(1)$ gauge group does not appear at low energies, and simply provides fundamental flavors from its bi-fundamentals. Again one can argue as above to show that this theory breaks supersymmetry.

Notice that the qualitative picture of this system in the gravity dual is quite different from the previous theories. Namely we have a small number of fractional D-brane probes in a nice and smooth complex deformed geometry. It would be interesting to find out more about the nature of the gravity description of this dual D-brane, and the way in which supersymmetry is broken in the gravity picture.

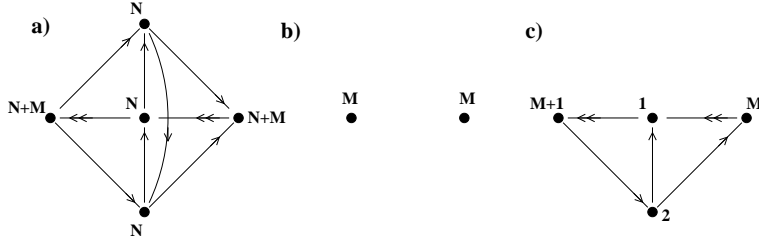

Figure 10: Figures a) shows the quiver theory describing dP_2 with N D3-branes and M fractional branes of the $(1, 1, 0, 0, 0)$ kind, while figure b) shows the quiver for the infrared limit of the corresponding duality cascade. Figure c) shows the addition of a fractional D-brane probe of the $(1, 0, 1, 0, 2)$ kind to that theory.

5.2 The dP_3 case

Consider now the dP_3 theory. This theory has been constructed in [18]. Diverse aspects of this theory have been studied in [19, 20, 21, 22, 23, 4]

We focus on the dP_3 phase whose quiver is shown in Figure 11, with superpotential

$$\begin{aligned}
 W = & X_{12}X_{23}X_{34}X_{45}X_{56}X_{61} + X_{13}X_{35}X_{51} + X_{24}X_{46}X_{62} - \\
 & - X_{23}X_{35}X_{56}X_{62} - X_{13}X_{34}X_{46}X_{61} - X_{12}X_{24}X_{45}X_{51}
 \end{aligned}
 \tag{5.2}$$

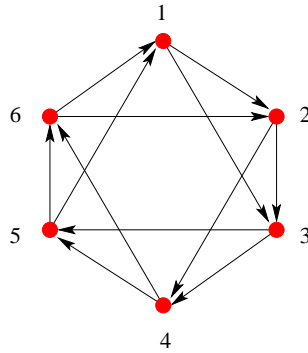

Figure 11: Quiver diagram for the dP_3 theory

The web diagram is shown in figure 12a.

The theory admits three independent fractional branes. A basis for them is given by the rank vectors $(1, 0, 0, 1, 0, 0)$, $(0, 1, 0, 0, 1, 0)$ and $(1, 0, 1, 0, 1, 0)$. For the general rank assignment, there is a supergravity throat solution constructed in [2], suggesting a UV cascade of the corresponding gauge theory. The field theory analysis of these candidate cascades has not been carried out in the general case, but some examples were explicitly constructed in [4].

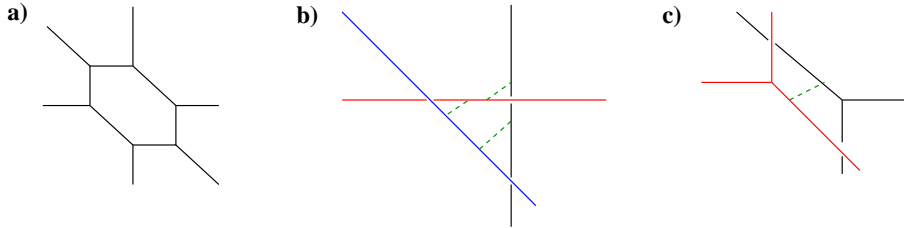

Figure 12: Web diagram for the cone over dP_3 , and its two complex deformations

We are interested in determining the infrared behavior of the theory for the general rank vector $(N + P + K, N + M, N + K, N + P, N + M + K, N)$. In [4] it was shown that for $K = 0$ and arbitrary M, P the cascade ends in a supersymmetric confining theory, whose gravity dual is described in terms of a two-parameter complex deformation of the geometry, as shown in figure 12b. On the other hand, for $M = P = 0$ and arbitrary K the cascade ends in a confining theory corresponding to the complex deformation in figure 12c.

There remains the question of the infrared behavior in the general case of non-vanishing M, P, K . Notice that dP_3 shows a new feature, compared with lower del Pezzo examples. Namely, it has the same number of complex deformation parameters and of independent fractional branes. One may be tempted to propose that the generic fractional brane leads to a general combination of complex deformations. However, this is clearly not possible, since the two complex deformations in Figures 12b and 12c are incompatible, hence we do not expect the infrared behavior of the generic fractional brane to be described by a complex deformation. Correspondingly, the infrared field theory does not reduce to a set of decoupled SYM theories without matter (or any other quiver corresponding to a deformation brane).

We are thus again led to discussing the dynamics of the infrared theories on fractional D-branes. The situation is again strongly suggestive of DSB in the general case. Moreover, this can be easily checked explicitly in some simple situations by setting to 1 the number of fractional branes of a given kind.

For instance, the regime of large P and small K is illustrated by taking $K = 1$. We expect this theory to have a UV cascade triggered by the P fractional branes of the first kind (dual to a throat based on the complex deformation of the cone over dP_3 to the conifold [?]), with an IR influenced by the additional single brane probe. The gauge theory is shown in figure 13c. Again, it is easy to argue that this theory breaks supersymmetry dynamically. Namely, because we only have fractional branes, there are no classical flat directions, and all gauge invariants are frozen to zero. On the other hand, the $SU(P + 1)$ and the $SU(P)$ gauge groups generate ADS superpotentials which push their mesons to non-zero vevs.

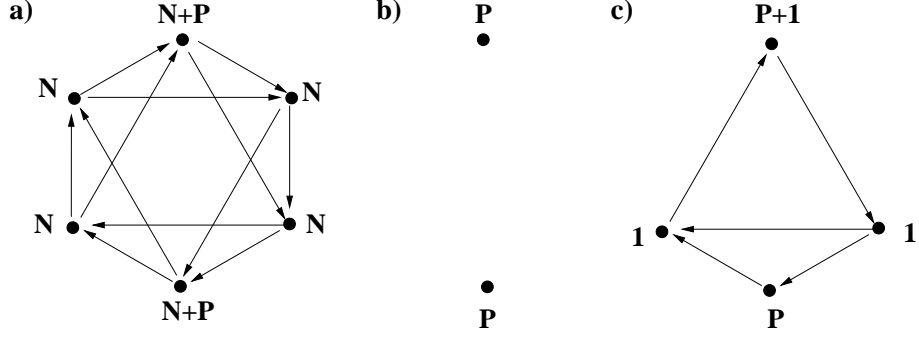

Figure 13: Quiver diagrams for the theory with P fractional branes of the $(1, 0, 0, 1, 0, 0)$ kind, at a generic point in the cascade (figure a), and in the infrared limit (figure b). Figure c shows the infrared limit of the same theory with an additional fractional brane of the $(1, 0, 1, 0, 1, 0)$ kind.

The interpretation of the DSB on the gravity side should be similar to that for the dP_2 theory in the previous section. Namely we have a single supersymmetry breaking D3-brane probe in a smooth complex deformed space.

Similar conclusions hold for example in the limit of small P and large K . Consider starting with large K and small M, P , e.g. $M = 0, P = 1$. The infrared limit of the theory in the absence of the latter is shown in figure 14b. Confinement of this theory triggers a complex deformation to smooth geometry. Adding now the $P = 1$ fractional brane the infrared theory is shown in figure 14c. One can easily show using by now familiar arguments that the theory breaks supersymmetry.

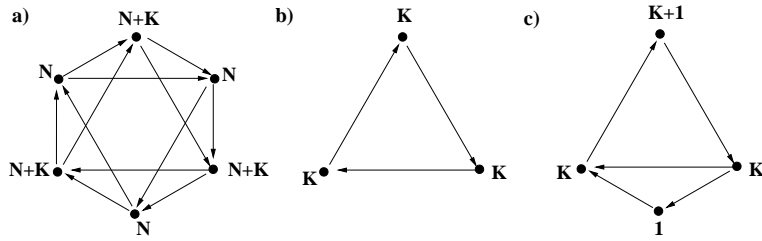

Figure 14: Quiver diagrams for the theory with K fractional branes of the $(1, 0, 1, 0, 1, 0)$ kind, at a generic point in the cascade (figure a), and in the infrared (figure b). Figure c shows the infrared limit of the same theory with one additional fractional brane of the $(1, 0, 0, 1, 0, 0)$ kind.

The general conclusion is that the generic choice of fractional branes leads to DSB, except for the rank choices studied in [4], namely those leading to ‘compatible’ complex deformations.

5.3 Beyond dP_3

The above analysis can be extended to other examples, and in particular to the cones over toric blowups of dP_3 (called pseudo del Pezzos (PdP) in [22]). The techniques and the physical pictures are identical to those in the above examples, so we simply discuss a few interesting situations.

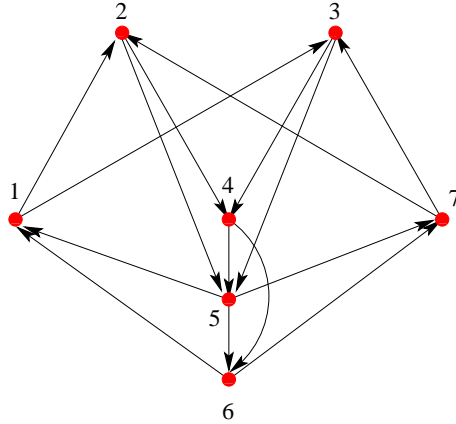

Figure 15: The quiver for the PdP_4 theory.

Let us center for example on phase I of the PdP_4 theory in [22]. The quiver diagram is shown in figure 15. The superpotential reads

$$\begin{aligned}
 W = & X_{24}X_{46}X_{61}X_{12} + X_{73}X_{35}X_{57} - X_{73}X_{34}X_{46}X_{67} - X_{45}X_{57}X_{72}X_{24} \\
 & - X_{35}X_{56}X_{61}X_{13} + X_{51}X_{13}X_{34}X_{45} - X_{25}X_{51}X_{12} + X_{25}X_{56}X_{67}X_{72}
 \end{aligned}
 \tag{5.3}$$

The web diagram is shown in figure 16

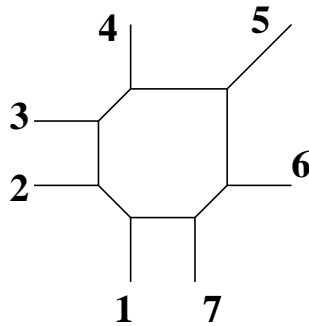

Figure 16: The web diagram for the PdP_4 theory.

A basis of fractional branes in this theory is provided by the rank vectors $(1, 0, 0, 1, 0, 0, 0)$, $(0, 1, 0, 0, 0, 1, 0)$, $(1, 1, 0, 0, 1, 0, 0)$ and $(1, 0, 1, 0, 1, 0, 0)$. The dynamics for the corresponding field theories are easy to identify following the discussion in Section 2. For instance, the

fractional branes $(1, 0, 0, 1, 0, 0, 0)$ and $(0, 1, 0, 0, 0, 1, 0)$ lead to quivers with decoupled nodes, hence lead to confinement triggering a complex deformation in the dual geometry (described by recombination of the legs 1 and 4, resp. 2 and 6, in the web diagram). The fractional brane $(1, 1, 0, 0, 1, 0, 0)$ leads to a quiver with three nodes joined by a loop of arrows, with the gauge invariant $X_{25}X_{51}X_{12}$ appearing in the superpotential. Hence it also corresponds to a deformation brane, producing the complex deformation obtained by recombining the legs 1, 2 and 5 in the web diagram. Finally, the fractional brane $(1, 0, 1, 0, 1, 0, 0)$ leads to a quiver with three nodes joined by a loop of arrows, but with the gauge invariant $X_{35}X_{51}X_{13}$ *not* appearing in the superpotential. Hence it is an $N = 2$ fractional brane. Notice that this is despite the fact that the web diagram suggests a complex deformation by recombination of the legs 1, 2 and 5. This is due to the familiar fact that web diagrams with parallel external legs sometimes miss important information concerning the superpotential of the quiver theories [44], and it is precisely the presence or not of certain superpotential terms that distinguishes certain $N = 2$ branes from deformation branes.

It is easy to construct other examples of fractional branes with nice supersymmetric infrared dynamics. Since cones over these higher del Pezzos contain many 2-cycles, equivalently fractional branes, the pattern is very rich. Indeed, there are new situations not present in previous examples. For instance, the theory given by the rank vector $(M, P, M, 0, M, P, 0)$ describes M $N = 2$ branes of type $(1, 0, 1, 0, 1, 0, 0)$ and P deformation branes of type $(0, 1, 0, 0, 0, 1, 0)$. The two are compatible, in the sense that the complex deformation does not remove the curve of A_1 singularities on whose collapsed 2-cycle the $N = 2$ fractional branes are wrapped. Hence the field theory should be supersymmetric and have a one-dimensional flat direction. This is indeed the case, upon careful analysis of the quiver field theory.

It is also easy, and in fact very generic, to have rank vectors which lead to DSB. Again, the pattern is very intricate, and we simply mention a few examples, which illustrate a particular point not manifest in previous theories. This is the key role played by the superpotential in the pattern of DSB, as illustrated in the following by two fractional brane theories with identical quiver but different superpotentials. Consider for instance the rank vector $(M + P, M, 0, P, M, 0, 0)$. The quiver diagram is shown in figure 17, and the superpotential is

$$W = -X_{25}X_{51}X_{12} \tag{5.4}$$

The theory does not have classical flat directions, since the F-term equation $X_{51}X_{12} = 0$ lifts the D-flat directions parametrized by vevs for the gauge invariants $X_{25}X_{51}X_{12}$ and $X_{51}X_{12}X_{14}X_{45}$. At the quantum level, the $SU(M + P)$ gauge factor develops an ADS

superpotential, which thus leads to a supersymmetry breaking minimum, using by now familiar arguments.

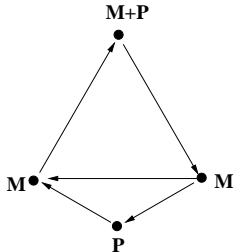

Figure 17: Quiver for certain fractional brane in the PdP_4 theory.

It is interesting to compare the situation with the theory given by the rank vector $(M + P, 0, M, P, M, 0, 0)$. The quiver diagram also corresponds to figure 17, but with node labels different from above. The superpotential is also different and reads

$$W = X_{51}X_{13}X_{34}X_{45} \quad (5.5)$$

Now there is a classical flat direction parametrized by $X_{35}X_{51}X_{13}$. At the quantum level, the $SU(M + P)$ gauge factor develops an ADS superpotential, which lifts the flat direction turning it into a runaway direction.

Clearly it is easy to construct many other examples with DSB patterns similar to those that appeared in previous theories. We leave a more systematic discussion as an exercise for the interested reader.

6. The $Y^{p,q}$ family

Recently an infinite class of Sasaki-Einstein 5d metrics on $S^2 \times S^3$ has been constructed, denoted $Y^{p,q}$, which can be used to build an infinite class of 6d conical Calabi-Yau geometries [45, 46, 47, 48, 49]. The dual quiver field theories on D3-brane on such singularities have been proposed in [26, 50]. The impressive matching between the field theory results and the the geometry in this family is exemplified by the matching of R-charges and volumes, which interestingly are in general irrational as follows by a -maximization [25, 26, 27].

The $Y^{p,q}$ theories thus provide an infinite class of examples to test new ideas in quiver gauge field theories with explicit gravity duals. Moreover, they can be exploited as in [8], to generate new infinite pairs of quivers/geometries by un-Higgsing.

In [3], warped throat solutions with 3-form fluxes were explicitly constructed, based on the conical metrics of $Y^{p,q}$, and hence containing a naked singularity at their origin. These

throats are expected to be dual to the RG flow of the dual field theory in the presence of fractional branes. In fact in [3] explicit duality cascades were described for particular choices of p, q . In this section we discuss the infrared behavior of the $Y^{p,q}$ theories in the presence of fractional branes.

As discussed in [4], the $Y^{p,q}$ theories do not admit complex deformations, except for $Y^{p,0}$ (which is simply a \mathbb{Z}_p quotient of the conifold). This follows from the fact that the corresponding web diagram (shown in figure 18) does not admit a splitting into subwebs in equilibrium. As in section 3, this would seem to contradict the recent explicit construction of a first order complex deformation in [16]. However it is possible to use mathematical results on complex deformations for toric singularities (see appendix A) to show that a first order deformation indeed exists, but is obstructed at second order.

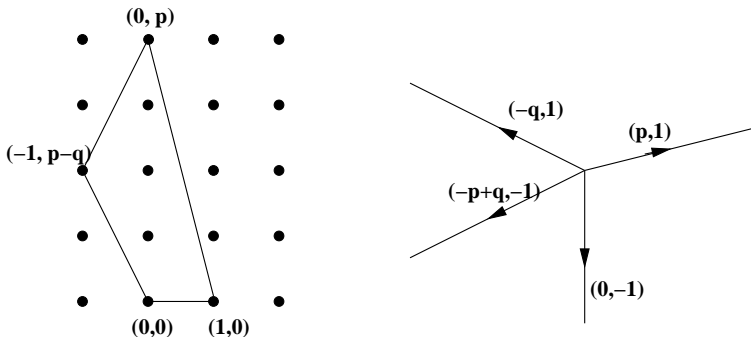

Figure 18: The toric and web diagram for the cone over the general $Y^{p,q}$ manifold. No leg recombination is possible except for the case $q = 0$.

On the other hand, $Y^{p,p}$ is an orbifold of flat space, and the fractional brane corresponds to an $N = 2$ subsector, thus its infrared dynamics is dominated by enhançon behaviors [12, 13, 14].

Following our general proposal, we claim that there is DSB for any of the $Y^{p,q}$ theories $0 < q < p$. To show this we simply need to consider the infrared theory where only fractional branes are present. In addition, we may choose any toric phase of the quiver field theory, since all are related by Seiberg duality, and hence have equivalent infrared dynamics. The toric ³ Seiberg dual phases of $Y^{p,q}$ quivers were fully classified in [50]. There, it was shown that they can be constructed by modifying $\mathbb{C}^3/\mathbb{Z}_{2p}$ quivers with so called single and double impurities. The effect of Seiberg duality is to move impurities around the quiver and double impurities are produced whenever single impurities collide. Out of the toric phases in [50], we

³Here we use the notation introduced in [21], where a quiver is denoted 'toric' when all the gauge groups have the same rank when only probe D3-branes are included.

focus on those with only single impurities. We can construct them by combining two building blocks, which we call no-impurity cell and impurity cell ⁴. We show them in Figure 19.

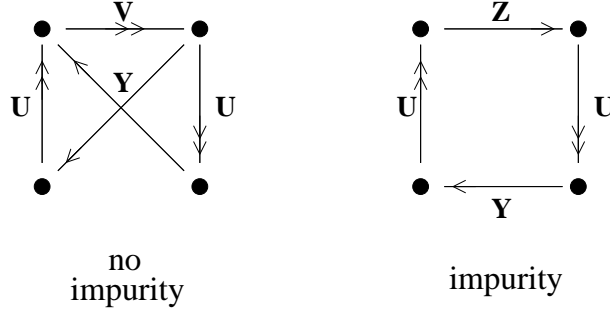

Figure 19: No-impurity and impurity fundamental cells for $Y^{p,q}$ quivers that only contain single impurities.

We find it convenient to choose the toric phase with $p - q$ single impurities next to each other (namely, a sequence of q no-impurity cells followed by $p - q$ impurity cells). This is shown in figure 20, where the nodes are periodically identified after p cells.

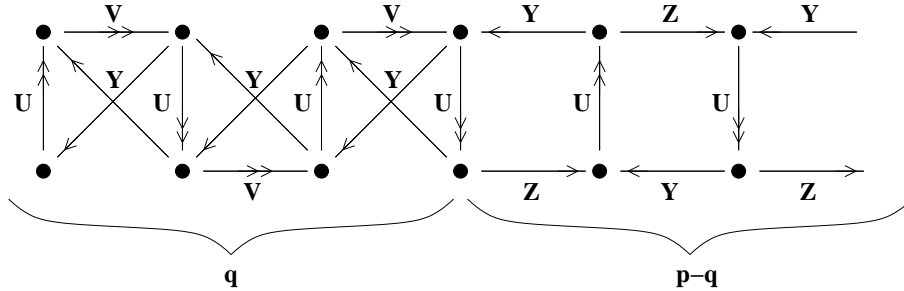

Figure 20: General picture of the toric phase of $Y^{p,q}$ that we are considering

We would like to consider the theory in the presence of fractional branes. In order to give the result of the corresponding rank vector, we choose to order the nodes starting with that in the lower left, and continuing the sequence of nodes by following the bifundamentals $U, V, U, V \dots$ (q times), and then $U, Z, U, Z \dots$ ($p - q$ times). Following the discussion in [50], the rank vector for fractional branes can be obtained by using the baryonic charges of the diverse bifundamental fields among the nodes. The charges for the bifundamentals in $Y^{p,q}$ theories are as follows [26]: U has charge $-p$, V has charge q , Z has charge $p + q$ and Y has

⁴This construction was originally conceived by Pavlos Kazakopoulos.

charge $p - q$. Using the ordering of nodes described above, the rank vector is

$$\vec{N} = p(0, 1, 1, 2, 2, 3, 3, \dots, q, q, (q+1); q, (q+1), q, (q+1), \dots, q, (q+1)) \\ -q(\underbrace{0, 0, 1, 1, 2, 2, \dots, (q-1), q, q}_{2(q+1)}; \underbrace{(q+1), (q+1), (q+2), (q+2), \dots, (p-1), (p-1)}_{2(p-q-1)}) \quad (6.1)$$

In a similar spirit, we can take the general version of the quiver, and compute a general expression for a vector \vec{N}_F , giving the numbers of flavors for each node,

$$\vec{N}_F = (\underbrace{N_{2p} + N_3, 2N_1 + N_4, 2N_2 + N_5, \dots}_{2q}; \underbrace{2N_{2q} + N_{2q+4}, 2N_{2q+1}, 2N_{2q+4}, 2N_{2q+3}, 2N_{2q+6}, 2N_{2q+5}, \dots, 2N_{2p-1}}_{2(p-q-1)}) \quad (6.2)$$

Notice that we have separated the $(2q + 1)$ - and $(2q + 2)$ -th nodes, which lie near the boundary of the impurity region in the quiver. The first node is also special. Using the general ranks in (6.1), we get

$$\vec{N}_F = p(2, 2, 4, 5, 7, 8, 10, 11, \dots, (3q-2), (3q-1); (3q+1), 2q; 2(q+1), 2q, 2(q+1), 2q, \dots, 2q) \\ -q(\underbrace{0, 1, 2, 4, 5, 7, 8, \dots, (3q-4), (3q-2)}_{2q}; \underbrace{(3q-1), 2q; 2(q+1), 2(q+1), 2(q+2), 2(q+2), \dots, 2(p-1)}_{2(p-q-1)}) \quad (6.3)$$

Using (6.1) and (6.3), we get

$$\vec{N}_F - \vec{N} = p(2, 1, 3, 3, 5, 5, \dots, (2q-1), (2q-1); (2q+1), (q-1); (q+2), (q-1), (q+2), (q-1), \dots, (q-1)) \\ -q(\underbrace{0, 1, 1, 3, 3, 5, 5, 7, \dots, (2q-3), (2q-1)}_{2q}; \underbrace{(2q-1), q; (q+1), (q+1), (q+2), (q+2), \dots, (p-1)}_{2(p-q-1)}) \quad (6.4)$$

We can now analyze this result. Consider the case $0 < q < p$. We realize that the last node has

$$N_F - N_c = p(q-1) - q(p-1) = -p + q \quad (6.5)$$

and hence generates an ADS superpotential. Combining it with the classical superpotential in [26], we conclude that fractional branes trigger DSB for the whole family of $Y^{p,q}$ theories (for $0 < q < p$). This is in agreement with the remark of absence of complex deformations in [4].

Note that for $p = q$, only the first $2p$ entries in (6.4) are present. All of them are greater or equal to zero and we see that there is no DSB. This theory corresponds to an orbifold

of flat space, and the fractional brane is of $N = 2$ type, hence leading to supersymmetric infrared dynamics. On the other hand, the case $q = 0$ is also special, and was analyzed in [4]. The infrared behavior of these theories is complex deformation, and is related to that of the conifold by a \mathbf{Z}_p orbifold action.

We conclude by showing how our expressions work in an explicit example, concretely the $Y^{4,2}$ theory. In this case, the ranks and flavors become

$$\vec{N} = (0, 4, 2, 6, 4, 8, 2, 6) \quad \vec{N}_F = (8, 6, 12, 12, 18, 8, 12, 4) \quad (6.6)$$

Then,

$$\vec{N}_F - \vec{N}_c = (8, 2, 10, 6, 14, 0, 10, -2) \quad (6.7)$$

And we conclude that node 8 develops an ADS superpotential.

It would be nice to extend this kind of general analysis to other infinite families of toric singularities, like the $X^{p,q}$ theories in [8]. In the meantime, it is straightforward to carry out the analysis in many different concrete examples.

7. Brane tilings and fractional branes

In [10] a new type of brane configurations dual to gauge theories on D3-branes probing arbitrary toric singularities was introduced. They were named **brane tilings** and encode both the quiver and the superpotential of the gauge theory. Brane tilings provide a connection to dimer models (see [9] for an introduction in the present context) and considerably simplify the study of these theories. In particular, the previously laborious task of finding the moduli space of the gauge theory is reduced to the computation of the determinant of the Kasteleyn matrix of a graph.

A brane tiling consists of an NS5-brane spanning the 0123 directions and wrapping an holomorphic curve in 4567. A simple way to visualize this configuration is by considering the intersection of this curve with the 46 plane, where it resembles a tiling. In addition to the NS5-brane, D5-branes extend in the 0123 directions and are finite in 46, being suspended from the NS5-brane like soap bubbles, and filling the faces of the tiling. The 4 and 6 coordinates are periodically identified, i.e. the configuration lives on the surface of a 2-torus.

The projection on the 46 plane defines a bipartite graph. There is an explicit mapping between the tiling and the corresponding gauge theory. Faces in the graph are mapped to gauge groups, edges to bifundamental fields and nodes to superpotential terms. We refer the reader to [10] for a detailed exposition of the correspondence.

7.1 Brane tiling perspective of fractional branes

It is natural to address the issue of fractional branes in the brane tiling context. As we have discussed, fractional branes correspond to anomaly free rank assignments in the quiver. The number of D5-branes in each face of the tiling gives the rank of the associated gauge group. Thus, rank vectors involving only 0 or 1 entries can be represented by coloring the brane tiling in a two color ‘chessboard’ fashion. The classification of fractional branes outlined in Section 2 becomes very intuitive under this new light ⁵. Using the gauge theory/tiling dictionary of [10], the different types of fractional branes become:

‘Deformation’ fractional branes: there are two types of deformation branes. They can correspond to either decoupled $SU(N)$ gauge group without flavors (set of isolated faces, possibly touching each other at nodes in the tiling) or to closed loop in the quiver with the corresponding term present in the superpotential (clusters of faces surrounding a given node in the tiling). These two types of chessboard configurations are by construction anomaly free.

$N = 2$ **fractional branes:** in this case the colored faces in the tiling form ‘strips’. Every shaded face has an even number of shaded neighbors, located such that they contribute an equal number of incoming and outgoing arrows into the face, rendering the configuration anomaly free. These strips map to closed loops in the quiver that are not contained in the superpotential.

DSB branes: All the other anomaly free assignments of ranks corresponds to DSB branes. Moreover, DSB branes involve rank vectors in which the non-zero entries are not all identical, and thus they cannot be represented by simple two color shadings of the tiling. The non-abelian dynamics associated to some of these higher-rank gauge factors results in DSB as described in previous sections.

Let us illustrate these ideas with some explicit examples. We start with model I of dP_3 . The brane tiling for this theory was introduced in [10], and we present it in Figure 21.

This theory has a fractional brane given by the rank vector $(1, 0, 0, 1, 0, 0)$ which triggers a complex deformation in the gravity dual. Painting the faces in the tiling accordingly, we obtain Figure 22.a. The configuration is given by isolated faces in the tiling and thus corresponds to the first type of deformation fractional branes. There is a similar fractional brane given e.g. by a rank vector $(0, 1, 0, 0, 1, 0)$. Its associated tiling configuration is identical up to a rotation so we do not present it.

⁵Similar considerations for DSB in brane setups were made in [11].

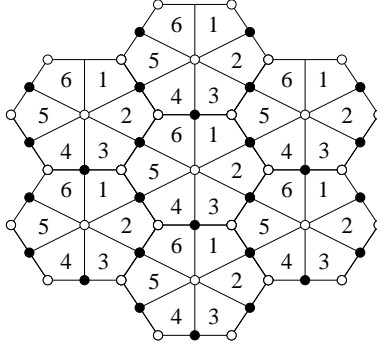
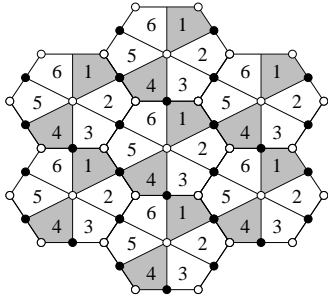
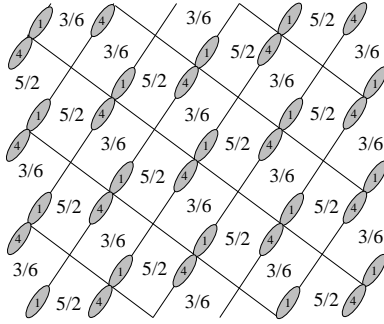

Figure 21: Brane tiling for model I of dP_3 .



(a)



(b)

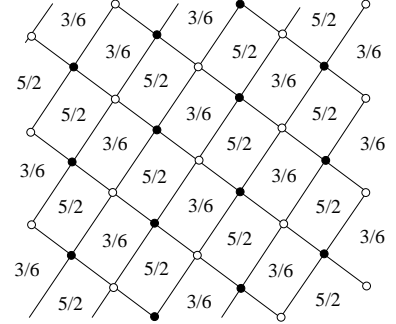

(c)

Figure 22: a) Brane tiling for the $(1,0,0,1,0,0)$ deformation fractional brane of model I of dP_3 . b) and c) Complex deformation to the conifold.

Brane tilings also provide a useful way of visualizing IR deformations. We can think about the process as a recombination of faces in the tiling, reflecting the higgsing of the corresponding gauge groups due to meson vevs (so that faces 2 and 5 combine into a face $5/2$, and similarly for 3 and 6), and the subsequent removal of the shaded tiles, due to confinement. Figure 22.bc represents the deformation that takes place for an equal number of regular D3-branes and $(0,1,0,0,1,0)$ fractional branes, leading to the brane tiling of the conifold theory. This type of figure should not be interpreted as an exact step by step description of the dynamical process, but as a helpful bookkeeping diagram.

There is also another deformation brane, in this case of the second type, given by the rank vector $(1,0,1,0,1,0)$. Figure 23.a shows the associated tiling. Once again there is another fractional brane, given by the vector $(0,1,0,1,0,1)$, which is identical to the previous one under a rotation. In this case, a similar picture of faces of the tiling being combined by meson vevs can be used to describe the deformation as shown in Figure 23.bc. After the

process, we recover the brane tiling of the flat space theory, as expected.

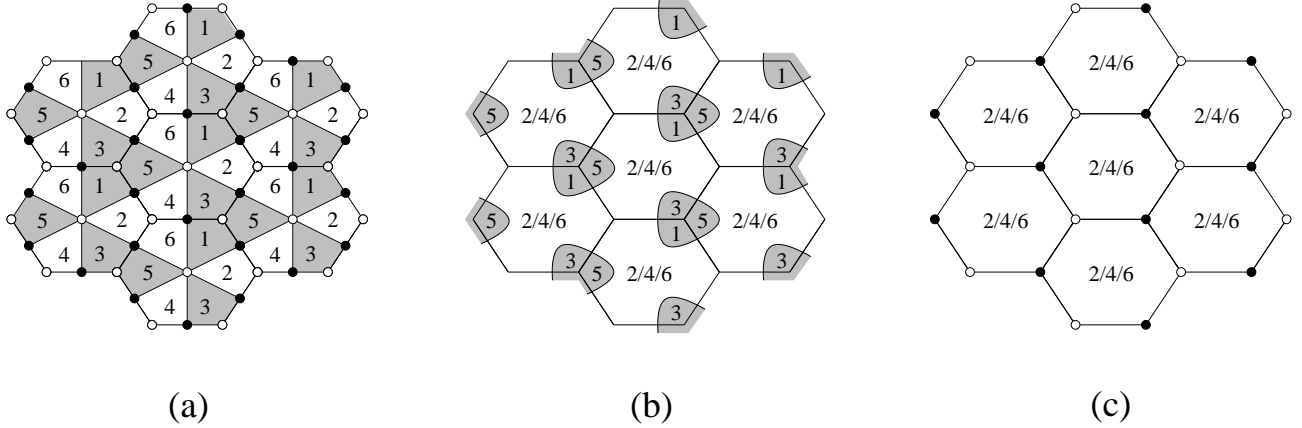

Figure 23: a) Brane tiling for the $(1, 0, 1, 0, 1, 0)$ deformation fractional brane of model I of dP_3 . b) and c) Complex deformation to \mathbb{C}^3 .

Let us now consider an example of $\mathcal{N} = 2$ fractional branes. Figure 24.a shows the brane tiling for the $\mathbb{C}^2/\mathbb{Z}_2$ orbifold. The fractional brane associated to the $(1, 0)$ rank vector is obtained by painting the strip of all faces corresponding to node 1 as in Figure 24.b. The modulus corresponds to recombining all painted faces by the vev of the adjoint, and to sliding the recombined strip off the picture, suspended between the NS branes on the boundary of the strip.

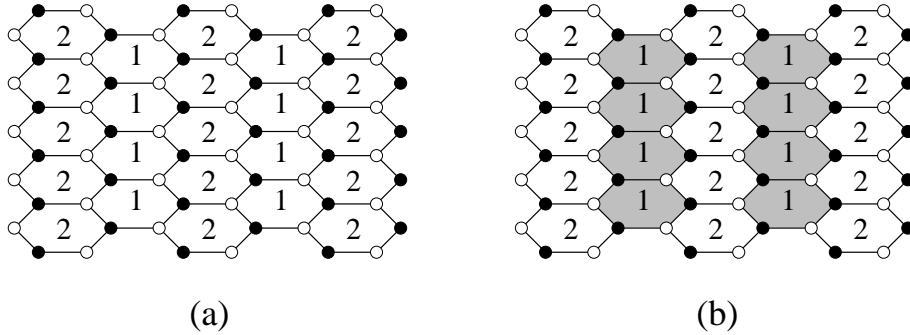

Figure 24: a) Brane tiling for $\mathbb{C}^2/\mathbb{Z}_2$. b) Tiling representation of the $(1, 0)$ $\mathcal{N} = 2$ fractional brane.

We now consider model I of PdP_4 , which has both deformation branes and $\mathcal{N} = 2$ branes. The quiver diagram and superpotential for this theory can be found in [22]. Its brane tiling can be constructed according to the rules in [10] and is shown in Figure 25.

There are different kinds of fractional branes, and we consider some interesting ones in the following. The $(1, 0, 0, 1, 0, 0, 0)$ fractional brane is shown in Figure 26.a. It is a

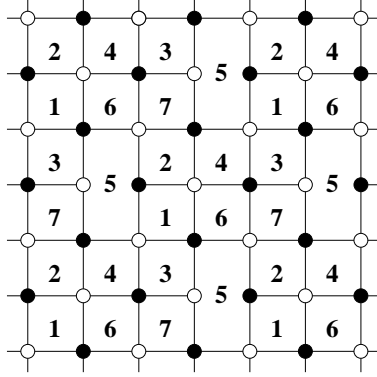

Figure 25: Brane tiling for model I of PdP_4 .

deformation fractional brane. There are other similar fractional branes, related to it by symmetry, like $(0, 1, 0, 0, 0, 1, 0)$.

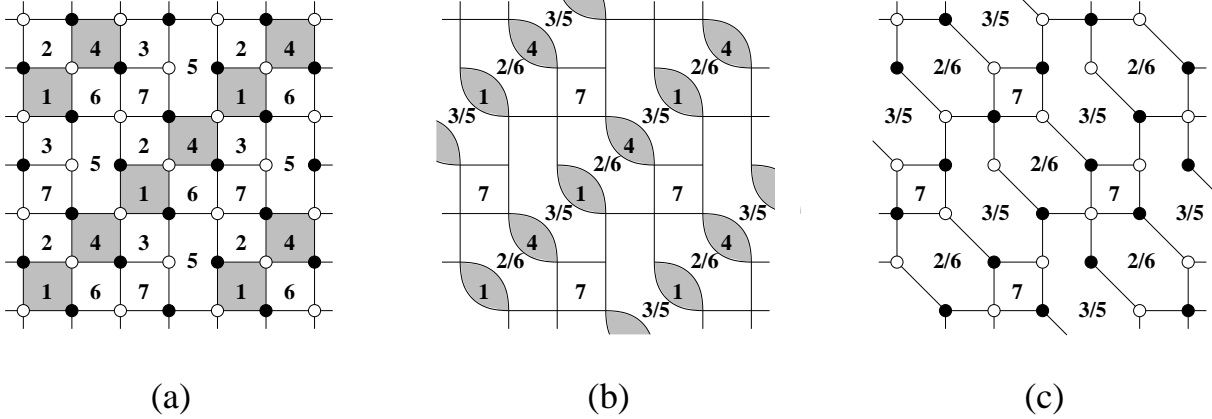

Figure 26: a) Brane tiling for the $(1, 0, 0, 1, 0, 0, 0)$ deformation fractional brane of model I of PdP_4 . b) and c) Complex deformation to the SPP .

As in the above examples, we can carry out the deformation at the level of the brane tiling. For this fractional brane, we obtain a deformation to the SPP tiling as shown Figure 26.bc. This agrees with the findings in [4]. Interestingly, the tiling picture even captures the appearance of massive fields (corresponding to 2-valent nodes [10]) which have to be integrated out using their equations of motion to arrive at the IR theory.

Figure 27.a shows the $(1, 1, 0, 0, 1, 0, 0)$ deformation fractional brane. The corresponding deformation, leading to the conifold tiling, is shown in Figure 27.bc. This agrees with the results of [4].

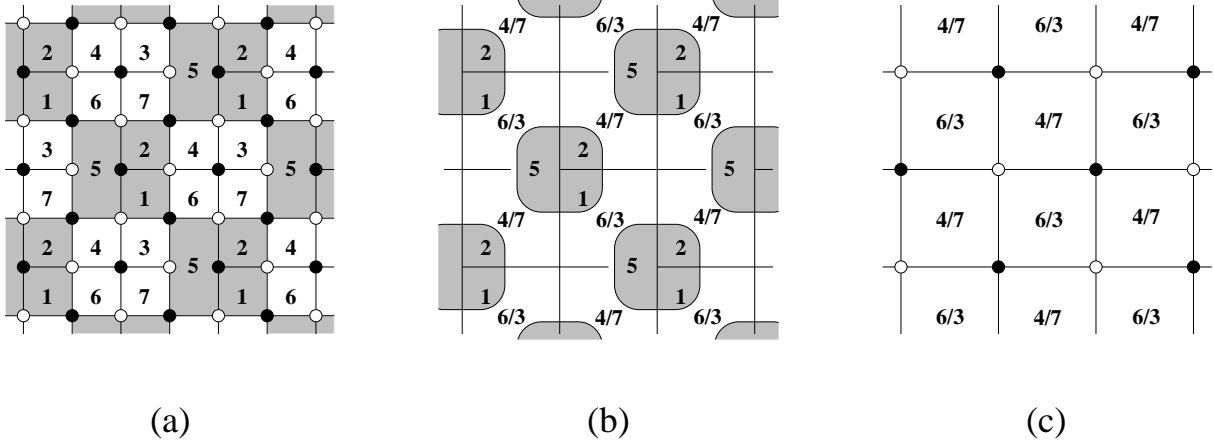

Figure 27: a) Brane tiling for the $(1, 1, 0, 0, 1, 0, 0)$ deformation fractional brane of model I of PdP_4 . b) and c) Complex deformation to the conifold.

Finally, the $(1, 0, 1, 0, 1, 0, 0)$ brane, shown in Figure 28, is an $\mathcal{N} = 2$ fractional brane. Similarly to what happens in the $\mathbb{C}^2/\mathbb{Z}_2$ case, its modulus parametrizes the possibility of detaching the strip of painted faces and sliding it along the NS5-brane along the boundary of the strip.

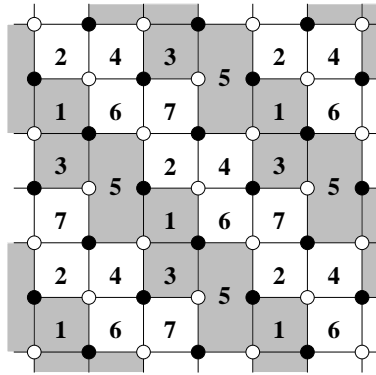

Figure 28: Brane tiling for the $(1, 0, 1, 0, 1, 0, 0)$ $\mathcal{N} = 2$ fractional brane of model I of PdP_4 .

We conclude that brane tilings are a useful tool for the study of deformation and $\mathcal{N} = 2$ fractional branes. The left over tiling encodes the result of the strong dynamics they trigger. A brane tiling representation of DSB fractional branes is admittedly more complicated, since they involve more than two different ranks. We nevertheless hope interesting progress in understanding the physics of DSB fractional branes using brane tiling techniques.

7.2 Beta function relations and baryonic $U(1)$ symmetries from brane tilings

There is a close relation between fractional branes and baryonic $U(1)$ symmetries in quiver gauge theories. In this section we exploit the brane tiling picture of fractional branes to describe a subset of these $U(1)$'s.

In a super conformal field theory, the $U(1)$ R-symmetry can in principle mix with every anomaly free $U(1)$ global symmetry that commutes with charge conjugation. In other words, in the presence of n additional $U(1)$'s, the space of R-charges satisfying the constraints that all beta functions (i.e beta functions for gauge and superpotential couplings) vanish is n -dimensional. This apparent freedom in the choice of the R-charge is fixed by the a-maximization principle [51].

For gauge theories constructed using brane tilings, there is one beta function for each face (gauge coupling g_I) and for each node (superpotential coupling h_α). They are given, upto multiplicative factors, by

$$\begin{aligned}\beta_{h_\alpha} &= \sum_i R_i - 2 & i \in \text{edges ending on node } \alpha \\ \beta_{g_I} &= 2 + \sum_i (R_i - 1) & i \in \text{edges around face } I\end{aligned}\tag{7.1}$$

Hence, the total number of beta functions is

$$N_g + N_w = N_f\tag{7.2}$$

where N_g is the number of gauge groups, N_w the number of superpotential terms and N_f the number of bifundamental fields. The above equality follows from Euler's formula applied to the tiling brane, taking into account that it lives on the surface of a 2-torus [10]. The number of beta functions is then, a priori, equal to the number of fields. We conclude that any additional dimension in the space of R-charges solving the vanishing of the beta functions (which we saw corresponds to a $U(1)$) must come from a non-trivial relation between some of the beta functions.

There is an important subset of global $U(1)$ symmetries, denoted **baryonic**. They are gauge symmetries in the $AdS \times X_5$ gravity dual, with their corresponding gauge bosons coming from the reduction of the RR $C^{(4)}$ over compact 3-cycles in X_5 [24]. They are called baryonic because dibaryon operators in the gauge theory are dual to D3-branes wrapping 3-cycles in X_5 and are thus naturally charged under them. It is important not to confuse these baryonic symmetries with the baryon number, which does not commute with charge conjugation and thus cannot mix with the R-symmetry. There is one baryonic $U(1)$ for each fractional brane. Intuitively this is because fractional branes correspond to D5-branes

wrapped over 2-cycles in X_5 and $b_2(X_5) = b_3(X_5)$. More technically, because one can use the baryonic charges to define the rank vector of a fractional brane [50].

There can be additional global $U(1)$ symmetries that can also mix with the R-charge, arising from isometries of X_5 , but they are not related to any fractional brane. The prototypical example is given by the dP_1 (or $Y^{2,1}$) theory [25] and the general $Y^{p,q}$ quivers [26], for which there is a single type of fractional brane, but there are two global $U(1)$'s in addition to the R-symmetry (the one usually referred to as $U(1)_F$ [26] is the one coming from isometries).

Combining the statements above we see that every fractional brane implies a non-trivial relation among beta functions. Brane tilings give a straightforward way to identify the beta function combinations associated to deformation and $\mathcal{N} = 2$ fractional branes. For each chessboard coloring of the tiling we have

$$\sum_I \beta(g_I) - \sum_\alpha c_\alpha \beta(h_\alpha) = 0 \quad (7.3)$$

where the I runs over colored faces and α runs over nodes that are fully contained in the shaded region (i.e. nodes such that all the edges connected to them are on the boundary of at least one shaded face). The value of c_α is 2 if all the faces around the given node are colored and 1 otherwise. This idea is a generalization of the one introduced in [52] for brane boxes.

Lets us now see how these ideas apply to model I of dP_3 . Figure 29 shows the tilings for the $(1, 0, 0, 1, 0, 0)$ and $(1, 0, 1, 0, 1, 0)$ fractional branes. We have indicated the fundamental cell and also labeled nodes.

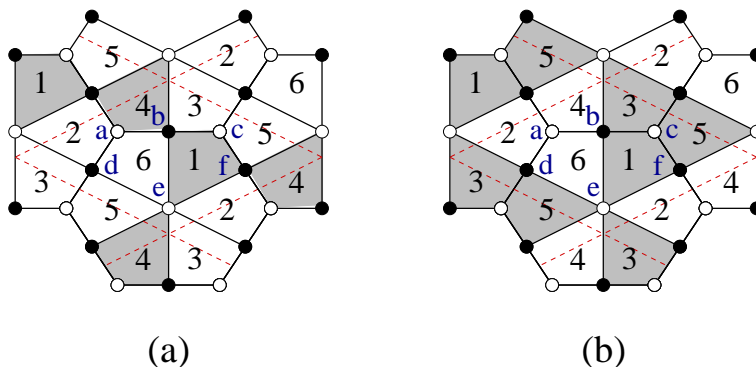

Figure 29: Tilings corresponding to deformation branes of model I of dP_3 . a) $(1, 0, 0, 1, 0, 0)$ brane. b) $(1, 0, 1, 0, 1, 0)$ brane.

From Figure 29.a, we see that the $(1, 0, 0, 1, 0, 0)$ brane gives rise to the following relation between the beta functions for g_1 and g_4 and the ones for the couplings h_b and h_f of two quartic superpotential terms.

$$\beta_{g_1} + \beta_{g_4} - \beta_{h_b} - \beta_{h_f} = 0 \quad (7.4)$$

From Figure 29.b, we deduce the following relation between the beta functions for the gauge couplings g_1, g_3, g_5 , and the superpotential couplings h_c (cubic term) and h_e (sixth order term).

$$\beta_{g_1} + \beta_{g_3} + \beta_{g_5} - 2\beta_{h_c} - \beta_{h_e} = 0 \quad (7.5)$$

8. Conclusions

In this paper we have studied the gauge theory dynamics on systems of fractional branes (possibly in the presence of D3-branes) at toric CY singularities. This has led to a classification of fractional branes in terms of the IR behavior of the gauge theory. We have recovered the known cases where this dynamics preserves supersymmetry, and leads to either confinement or $N = 2$ dynamics. Moreover, we have observed that the generic fractional brane leads to breakdown of supersymmetry due to non-perturbative superpotentials. When the dynamics of FI terms (related to localized closed string moduli) or baryonic operators is taken into account, we are lead to runaway behaviors as discussed in section 3.2.3. Geometrically, non-supersymmetric behavior occurs whenever the fractional brane does not have an associated complex deformation. For toric geometries, we have studied how complex deformations are easily characterized in terms of possible splittings of the web diagram into subwebs in equilibrium. This criterion translates into a rigorous prescription in terms of possible decompositions of the toric polytope into Minkowsky sum of sub-polytopes (see appendix A).

Our results have important implications concerning the dual supergravity throats describing the UV duality cascades of such gauge theories. In particular, they show that the naked singularities of such throats generically cannot be smoothed by the standard mechanism of complex deformation (since, in the best of cases, such deformations exist at a given order but are obstructed at higher orders being impossible to integrate them to full deformations). The smoothing should rather be non-supersymmetric (hence going far beyond the standard ansatz of conformal CY metrics with ISD 3-form fluxes), and should very possibly lead to unstable backgrounds. Hence, the expectation from the gauge theory side is that

there exists no smooth supergravity configuration obeying the equations of motion, and with the asymptotics of the warped throats with 3-form fluxes (for choices of fluxes corresponding to DSB fractional branes).

It would be very interesting to find independent information on the nature of the singularities for such supergravity throats, in order to find more direct information about them. One possible tool ⁶ would be the introduction of e.g. D5-branes wrapped on the 2-cycle of $Y^{p,q}$ as a probe of the infrared limit of the throats in [3].

We have also shown that brane tiling configurations are useful tools for the study of deformation and $N = 2$ fractional branes. It would be nice to develop an appropriate picture of DSB branes, and its non-perturbative dynamics, in this language.

We expect much progress in addressing these and other questions in the setup of branes at singularities and its dual versions.

Acknowledgements

We thank J.F.G. Cascales, Y. H. He, S. Kuperstein, M. Mahato, D. Martelli, C. Nuñez, Y. Oz, J. Sonnenschein, L. Pando Zayas, R. Russo and D. Vaman for useful discussions. F. S. thanks the CERN PH-TH Division for hospitality during completion of this work and the spanish Ministerio de Educacion y Ciencia for financial support through an F.P.U grant. A. M. U. thanks M. González for encouragement and support. The research of S. F. and A. H. was supported in part by the CTP and LNS of MIT and the U.S. Department of Energy under cooperative research agreement # DE-FC02-94ER40818, and by BSF American-Israeli Bi-National Science Foundation. A. H. is also indebted to a DOE OJI Award. The research of A. M. U. and F. S. was supported by the CICYT, Spain, under project FPA2003-02877, and by the networks MRTN-CT-2004-005104 ‘Constituents, Fundamental Forces and Symmetries of the Universe’, and MRTN-CT-2004-503369 ‘Quest for Unification’.

A. Deformations and obstructions for isolated toric singularities

In this appendix we describe some useful results by K. Altmann [53, 54] (see [55] for a complete discussion), concerning the possible complex deformations of toric singularities, and their obstructions.

Three-dimensional Gorenstein (i.e. CY) toric singularities are described by toric cones with base given by a polytope (compact polygon) lying on a 2-plane. Let us denote a^i ,

⁶We thank D. Martelli for discussions on this point.

$i = 1, \dots, N$ the 2d vectors defining the positions of its vertices, and $d^i = a^{i+1} - a^i$ the edges (with the understanding that $d^N = a^1 - a^N$). In order to be isolated, the polytope should have primitive edges. Namely there are no points on the edges of the polygon, i.e. $d^{i+1} \neq d^i$ for all i .

Given two 2d polygons P_1, P_2 , one can define its Minkowski sum as the polygon $P = P_1 + P_2$ defined by $P = \{p = p_1 + p_2 \mid p_1 \in P_1, p_2 \in P_2\}$. Namely the set of vectors given as sums of vectors in the summand polygons. It is easy to realize that the polygon P has edges given by the union of the sets of edges of the polygons P_1, P_2 .

The complex deformations of isolated Gorenstein singularities are completely characterized in terms of the possible decompositions of the toric polytope into a Minkowski sum of polytopes. It is easy to see that this is equivalent to the criterion used along the paper that the web diagram (dual to the toric polygon) splits into a set of subwebs in equilibrium (dual to the summand polygons). Figure 30 shows the two decompositions of the polytope for the complex cone over dP_3 , whose relation to the dual picture of splitting into subwebs (figure 12) is manifest.

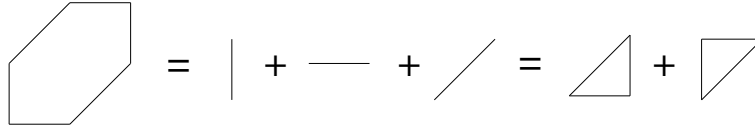

Figure 30: The two decompositions of the toric polygon of the cone over dP_3 as a Minkowski sum. The two decompositions correspond to the two splittings into subwebs in figure 12.

Following [53, 54], the parameter space of complex deformations of a isolated CY singularity, allowed up to order K (i.e. not obstructed up to order $K + 1$) is the subspace of \mathbb{C}^N obeying the equations

$$\sum_{i=1}^N (t_i)^k d^i = 0 \quad 0 < k \leq K \quad (\text{A.1})$$

Since the equations are homogeneous, there is one overall scaling which should be removed, leading to a projective parameter space. True complex deformations satisfy the above equation for all $k > 0$. In fact, it is enough to verify this up to a (polytope dependent) finite value K_0 , which guarantees the equations for $k > K_0$ are also satisfied ⁷.

For true complex deformations, solutions t_i to the above equations parametrize the base space of the so-called versal deformation space. This means that any complex deformations

⁷The value K_0 can be obtained as follows: define the polytope as the intersection set of a strips in the 2d space. K_0 is the lattice thickness of thickest such strip.

of the defining equations of the toric singularity can be written in terms of the t_i 's, which are hence the deformation parameters. A complex deformation can be associated to a Minkowski decomposition of the polytope, by gathering edges with same value of t_i in the solution.

This description provides a characterization of true complex deformations, and moreover of deformations valid at order K but obstructed at order $K + 1$. Let us apply this formalism to some situations of interest.

For any toric singularity of the kind described above, the first order deformations lie in a subset of \mathbb{C}^N given by

$$\sum_i t_i d^i = 0 \tag{A.2}$$

These are two equations for N variables, and we should remove the scaling. This leaves $N - 3$ first order deformations. This shows that the cone over dP_0 has no deformations, and e.g. that the cones over $Y^{p,q}$ have one first order deformation.

Let us consider the $Y^{p,q}$ theories, whose toric diagram is shown in figure 18, in more detail. Since for $q \neq 0$ no splitting of the web diagram into subwebs in equilibrium, we expect that the first order deformations are obstructed at some higher order, for $q \neq 0$. This can be verified explicitly with our above formula. We have $a^1 = (0, 0)$, $a^2 = (1, 0)$, $a^3 = (0, p)$, $a^4 = (-1, p - q)$, and hence $d^1 = (1, 0)$, $d^2 = (-1, p)$, $d^3 = (-1, -q)$, $d^4 = (1, -(p - q))$.

The equations for the space of complex deformations read

$$\begin{aligned} t_1^k - t_2^k - t_3^k + t_4^k &= 0 \\ p t_2^k - q t_3^k - (p - q) t_4^k &= 0 \end{aligned} \tag{A.3}$$

The case $q = 0$ stands out as special. The equations correspond to

$$\begin{aligned} t_1^k - t_2^k - t_3^k + t_4^k &= 0 \\ p t_2^k - p t_4^k &= 0 \end{aligned} \tag{A.4}$$

At linear order we have

$$\begin{aligned} t_1 - t_2 - t_3 + t_4 &= 0 \\ t_2 - t_4 &= 0 \end{aligned} \tag{A.5}$$

Hence $t_4 = t_2$ and $t_1 = t_3$. So there is one complex deformation. It is easy to see that it obeys all the equations for $k > 1$, so it is not obstructed at any order. This is in agreement with the fact that $Y^{p,0}$ is an orbifold of the conifold, with the quotient preserving the complex

deformation of the conifold. Notice that the absence of obstruction is nicely linked to the relations between the d^i 's, and hence to the possibility of web recombination. Concretely, the complex deformation can be described as the splitting into two subwebs given by straight lines, or in terms of a decomposition of the polytope as a Minkowski sum of two segments.

Let us consider the generic case $q \neq 0$. For $0 < q < p$, we have at linear order

$$\begin{aligned} t_1 - t_2 - t_3 + t_4 &= 0 \\ p t_2 - q t_3 - (p - q) t_4 &= 0 \end{aligned} \tag{A.6}$$

This gives

$$t_1 = \frac{p+q}{p}t_3 - \frac{q}{p}t_4 \quad , \quad t_2 = \frac{q}{p}t_3 + \frac{p-q}{p}t_4 \tag{A.7}$$

Hence there is a two-parameter solution to the equations, one of which is complete rescaling. Hence there is one deformation at first order.

At second order, we have to impose the additional conditions

$$\begin{aligned} t_1^2 - t_2^2 - t_3^2 + t_4^2 &= 0 \\ p t_2^2 - q t_3^2 - (p - q) t_4^2 &= 0 \end{aligned} \tag{A.8}$$

Using (A.6) in the first equation, one obtains

$$q(t_3 - t_4)^2 = 0 \tag{A.9}$$

hence for $q \neq 0$ we obtain $t_3 = t_4$. Using the rest of the equations one easily obtains $t_1 = t_2 = t_3 = t_4$. This simply corresponds to a total rescaling and does not describe a complex deformation. Hence there is no complex deformation at second order, namely the first order complex deformation is obstructed at second order.

This mathematical result explains that, despite the first order deformation, constructed explicitly in [16], the geometries $Y^{p,q}$ do not admit complex deformations, and hence they cannot provide a smoothing of the naked singularities in the throats in [3].

It is straightforward to describe in this language complex deformations mentioned in the main text in terms of splitting into subwebs in equilibrium. An interesting point is that for non-isolated Gorenstein singularities the description of complex deformations in terms of Minkowski sums is not complete. Physically, one can clearly associate these new mathematical subtleties to the appearance of a different kind of fractional branes (namely $N = 2$ fractional branes) for non-isolated toric singularities.

References

- [1] I. R. Klebanov and M. J. Strassler, “Supergravity and a confining gauge theory: Duality cascades and chiSB-resolution of naked singularities,” *JHEP* **0008**, 052 (2000) [arXiv:hep-th/0007191].
- [2] S. Franco, Y. H. He, C. Herzog and J. Walcher, “Chaotic duality in string theory,” *Phys. Rev. D* **70**, 046006 (2004) [arXiv:hep-th/0402120].
- [3] Q. J. Ejaz, C. P. Herzog and I. R. Klebanov, “Cascading RG Flows from New Sasaki-Einstein Manifolds,” arXiv:hep-th/0412193.
- [4] S. Franco, A. Hanany and A. M. Uranga, “Multi-flux warped throats and cascading gauge theories,” arXiv:hep-th/0502113.
- [5] O. Aharony, A. Hanany and B. Kol, “Webs of (p,q) 5-branes, five dimensional field theories and grid diagrams,” *JHEP* **9801**, 002 (1998) [arXiv:hep-th/9710116].
- [6] N. C. Leung and C. Vafa, “Branes and toric geometry,” *Adv. Theor. Math. Phys.* **2**, 91 (1998) [arXiv:hep-th/9711013].
- [7] J. Lykken, E. Poppitz and S. P. Trivedi, “Branes with GUTs and supersymmetry breaking,” *Nucl. Phys. B* **543**, 105 (1999) [arXiv:hep-th/9806080].
- [8] A. Hanany, P. Kazakopoulos and B. Wecht, “A new infinite class of quiver gauge theories,” arXiv:hep-th/0503177.
- [9] A. Hanany and K. D. Kennaway, “Dimer models and toric diagrams,” arXiv:hep-th/0503149.
- [10] S. Franco, A. Hanany, K. D. Kennaway, D. Vegh and B. Wecht, “Brane dimers and quiver gauge theories,” arXiv:hep-th/0504110.
- [11] A. Hanany and A. Zaffaroni, “On the realization of chiral four-dimensional gauge theories using branes,” *JHEP* **9805**, 001 (1998) [arXiv:hep-th/9801134].
- [12] C. V. Johnson, A. W. Peet and J. Polchinski, “Gauge theory and the excision of repulson singularities,” *Phys. Rev. D* **61**, 086001 (2000) [arXiv:hep-th/9911161].
- [13] M. Bertolini, P. Di Vecchia, M. Frau, A. Lerda, R. Marotta and I. Pesando, “Fractional D-branes and their gauge duals,” *JHEP* **0102**, 014 (2001) [arXiv:hep-th/0011077].
- [14] J. P. Gauntlett, N. Kim, D. Martelli and D. Waldram, “Wrapped fivebranes and $N = 2$ super Yang-Mills theory,” *Phys. Rev. D* **64**, 106008 (2001) [arXiv:hep-th/0106117].
- [15] M. Petrini, R. Russo and A. Zaffaroni, *Nucl. Phys. B* **608**, 145 (2001) [arXiv:hep-th/0104026].

- [16] B. A. Burrington, J. T. Liu, M. Mahato and L. A. P. Zayas, “Towards Supergravity Duals of Chiral Symmetry Breaking in Sasaki-Einstein Cascading Quiver Theories,” arXiv:hep-th/0504155.
- [17] D. R. Morrison and N. Seiberg, “Extremal transitions and five-dimensional supersymmetric field theories,” Nucl. Phys. B **483**, 229 (1997) [arXiv:hep-th/9609070].
- [18] B. Feng, A. Hanany and Y. H. He, “D-brane gauge theories from toric singularities and toric duality,” Nucl. Phys. B **595**, 165 (2001) [arXiv:hep-th/0003085].
- [19] B. Feng, A. Hanany and Y. H. He, “Phase structure of D-brane gauge theories and toric duality,” JHEP **0108**, 040 (2001) [arXiv:hep-th/0104259].
- [20] B. Feng, A. Hanany, Y. H. He and A. M. Uranga, “Toric duality as Seiberg duality and brane diamonds,” JHEP **0112**, 035 (2001) [arXiv:hep-th/0109063].
- [21] B. Feng, S. Franco, A. Hanany and Y. H. He, “Symmetries of toric duality,” JHEP **0212**, 076 (2002) [arXiv:hep-th/0205144].
- [22] B. Feng, S. Franco, A. Hanany and Y. H. He, “Unhiggsing the del Pezzo,” JHEP **0308**, 058 (2003) [arXiv:hep-th/0209228].
- [23] S. Franco and A. Hanany, “Geometric dualities in 4d field theories and their 5d interpretation,” JHEP **0304**, 043 (2003) [arXiv:hep-th/0207006].
- [24] K. Intriligator and B. Wecht, “Baryon charges in 4D superconformal field theories and their AdS duals,” Commun. Math. Phys. **245**, 407 (2004) [arXiv:hep-th/0305046].
- [25] M. Bertolini, F. Bigazzi and A. L. Cotrone, “New checks and subtleties for AdS/CFT and a-maximization,” JHEP **0412**, 024 (2004) [arXiv:hep-th/0411249].
- [26] S. Benvenuti, S. Franco, A. Hanany, D. Martelli and J. Sparks, “An infinite family of superconformal quiver gauge theories with Sasaki-Einstein duals,” arXiv:hep-th/0411264.
- [27] D. Martelli, J. Sparks and S. T. Yau, “The Geometric Dual of a-maximization for Toric Sasaki-Einstein Manifolds,” arXiv:hep-th/0503183.
- [28] Y. Shadmi and Y. Shirman, “Dynamical supersymmetry breaking,” Rev. Mod. Phys. **72**, 25 (2000) [arXiv:hep-th/9907225].
- [29] L. E. Ibanez, R. Rabadan and A. M. Uranga, “Anomalous U(1)’s in Type I and Type IIB D = 4, N = 1 string vacua,” Nucl. Phys. B **542**, 112 (1999) [arXiv:hep-th/9808139].
- [30] M. R. Douglas and G. W. Moore, “D-branes, Quivers, and ALE Instantons,” arXiv:hep-th/9603167.

- [31] M. R. Douglas, B. R. Greene and D. R. Morrison, “Orbifold resolution by D-branes,” Nucl. Phys. B **506**, 84 (1997) [arXiv:hep-th/9704151].
- [32] D. R. Morrison and M. R. Plesser, “Non-spherical horizons. I,” Adv. Theor. Math. Phys. **3**, 1 (1999) [arXiv:hep-th/9810201].
- [33] I. Affleck, M. Dine and N. Seiberg, “Dynamical Supersymmetry Breaking In Four-Dimensions And Its Phenomenological Implications,” Nucl. Phys. B **256**, 557 (1985).
- [34] O. Aharony and A. Hanany, “Branes, superpotentials and superconformal fixed points,” Nucl. Phys. B **504**, 239 (1997) [arXiv:hep-th/9704170].
- [35] A. Hanany and E. Witten, “Type IIB superstrings, BPS monopoles, and three-dimensional gauge dynamics,” Nucl. Phys. B **492**, 152 (1997) [arXiv:hep-th/9611230].
- [36] S. Elitzur, A. Giveon and D. Kutasov, “Branes and $N = 1$ duality in string theory,” Phys. Lett. B **400**, 269 (1997) [arXiv:hep-th/9702014].
- [37] E. Witten, “Solutions of four-dimensional field theories via M-theory,” Nucl. Phys. B **500**, 3 (1997) [arXiv:hep-th/9703166].
- [38] S. B. Giddings, S. Kachru and J. Polchinski, “Hierarchies from fluxes in string compactifications,” Phys. Rev. D **66**, 106006 (2002) [arXiv:hep-th/0105097].
- [39] M. Grana, “MSSM parameters from supergravity backgrounds,” Phys. Rev. D **67**, 066006 (2003) [arXiv:hep-th/0209200].
- [40] P. G. Camara, L. E. Ibanez and A. M. Uranga, “Flux-induced SUSY-breaking soft terms,” Nucl. Phys. B **689**, 195 (2004) [arXiv:hep-th/0311241].
- [41] M. Grana, T. W. Grimm, H. Jockers and J. Louis, “Soft supersymmetry breaking in Calabi-Yau orientifolds with D-branes and Nucl. Phys. B **690**, 21 (2004) [arXiv:hep-th/0312232].
- [42] A. M. Uranga, “Brane configurations for branes at conifolds,” JHEP **9901**, 022 (1999) [arXiv:hep-th/9811004].
- [43] D. Berenstein, “D-brane realizations of runaway behavior and moduli stabilization,” arXiv:hep-th/0303230.
- [44] B. Feng, Y. H. He and F. Lam, “On correspondences between toric singularities and (p,q)-webs,” arXiv:hep-th/0403133.
- [45] J. P. Gauntlett, D. Martelli, J. Sparks and D. Waldram, “Supersymmetric AdS(5) solutions of M-theory,” Class. Quant. Grav. **21**, 4335 (2004) [arXiv:hep-th/0402153].

- [46] J. P. Gauntlett, D. Martelli, J. Sparks and D. Waldram, “Sasaki-Einstein metrics on $S(2) \times S(3)$,” arXiv:hep-th/0403002.
- [47] J. P. Gauntlett, D. Martelli, J. F. Sparks and D. Waldram, “A new infinite class of Sasaki-Einstein manifolds,” arXiv:hep-th/0403038.
- [48] J. P. Gauntlett, D. Martelli, J. Sparks and D. Waldram, “Supersymmetric AdS backgrounds in string and M-theory,” arXiv:hep-th/0411194.
- [49] D. Martelli and J. Sparks, “Toric geometry, Sasaki-Einstein manifolds and a new infinite class of AdS/CFT duals,” arXiv:hep-th/0411238.
- [50] S. Benvenuti, A. Hanany and P. Kazakopoulos, “The toric phases of the $Y(p,q)$ quivers,” arXiv:hep-th/0412279.
- [51] K. Intriligator and B. Wecht, “The exact superconformal R-symmetry maximizes a ,” Nucl. Phys. B **667**, 183 (2003) [arXiv:hep-th/0304128].
- [52] A. Hanany, M. J. Strassler and A. M. Uranga, “Finite theories and marginal operators on the brane,” JHEP **9806**, 011 (1998) [arXiv:hep-th/9803086].
- [53] K. Altmann, ‘The versal Deformation of an isolated toric Gorenstein Singularity’, alg-geom/9403004.
- [54] K. Altmann, ‘Infinitesimal Deformations and Obstructions for Toric Singularities’, alg-geom/9405008.
- [55] K. Altmann, ‘Deformations of toric singularities’, Habilitationsschrift; Humboldt-Universitt zu Berlin 1995, available at <http://page.mi.fu-berlin.de/altmann/PAPER/>
- [56] D. Berenstein, C. P. Herzog, P. Ouyang and S. Pinansky, “Supersymmetry Breaking from a Calabi-Yau Singularity,” arXiv:hep-th/0505029.