

Status of the CMS Magnet (MT17)

A. Hervé, G. Acquistapace, D. Campi, P. Cannarsa, P. Fabbriatore, F. Feyzi, H. Gerwig, J. P. Grillet, I. L. Horvath, V. Kaftanov, F. Kircher, R. Loveless, J. M. Maugain, G. Perinic, H. Rykaczewski, E. Sbrissa, R. P. Smith, and L. Veillet

Abstract—The CMS experiment (Compact Muon Solenoid) is a general-purpose detector designed to run at the highest luminosity at the CERN Large Hadron Collider (LHC). Its distinctive features include a 4 T superconducting solenoid with a free bore of 6 m diameter and 12.5-m length, enclosed inside a 10 000-ton return yoke. The magnet will be assembled and tested in a surface hall at Point 5 of the LHC at the beginning of 2004 before being transferred by heavy lifting means to an experimental hall 90 m below ground level.

The design and construction of the magnet is a common project of the CMS Collaboration. The task is organized by a CERN based group with strong technical and contractual participation from CEA Saclay, ETH Zürich, Fermilab, INFN Genova, ITEP Moscow, University of Wisconsin and CERN. The magnet project will be described, with emphasis on the present status of the fabrication.

Index Terms—CMS magnet, compact muon solenoid.

I. INTRODUCTION

THE CMS experiment (Compact Muon Solenoid) is a general-purpose proton–proton detector designed to run at the highest luminosity at the LHC [1]. Distinctive features of the CMS detector include a high-magnetic-field solenoid (4 T) coupled with a multilayer muon system, a fully active scintillating-crystal electromagnetic calorimeter, a tile hadronic calorimeter, and a powerful inner tracking system (Fig. 1).

The single most important aspect of the overall detector design is the configuration and parameters of the magnetic field for the measurement of muon momenta. The requirement for good momentum resolution, without making stringent demands on the spatial resolution of muon chambers, leads naturally to the choice of a high solenoidal magnetic field. A long superconducting solenoid (12.5 m) has been chosen with a free inner diameter of 6 m and a uniform magnetic field of 4 T.

The muon spectrometer then consists of a single magnet allowing for a simpler architecture for the detector. The inner coil radius is large enough to accommodate the inner tracker and the full calorimeter.

Manuscript received September 24, 2001.

A. Hervé, G. Acquistapace, D. Campi, H. Gerwig, J. P. Grillet, J. M. Maugain, G. Perinic, E. Sbrissa, and L. Veillet are with CERN, 1211 Geneva 23, Switzerland (e-mail: alain.herve@cern.ch).

P. Cannarsa, I. L. Horvath, and H. Rykaczewski are with ETH, Swiss Federal Institute of Technology, 8093 Zürich, Switzerland.

P. Fabbriatore is with INFN, I-16146 Genova, Italy.

F. Feyzi is with the Physical Sciences Laboratory, Stoughton, WI 53589 USA.

V. Kaftanov is with ITEP, 117259 Moscow, Russia.

F. Kircher is with CEA Saclay, Dapnia, F-91191, Gif-sur-Yvette, France.

R. Loveless is with the University of Wisconsin, Madison, WI 53706 USA.

R. P. Smith is with Fermi National Accelerator Laboratory, Batavia, IL 60510 USA.

Publisher Item Identifier S 1051-8223(02)03569-8.

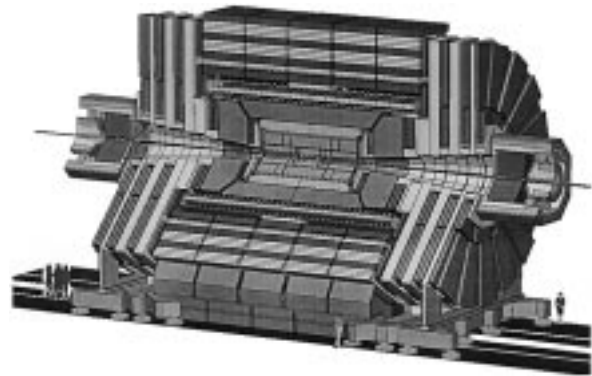

Fig. 1. Perspective view of the CMS experiment, showing the coil (outside the Hadronic Calorimeter) and surrounded by the three layers of iron (in light gray) in the barrel and in the endcaps.

The magnetic flux is returned via a 1.5-m-thick saturated iron yoke instrumented with four stations of muon chambers.

The CMS experiment is built and funded by an international collaboration of High Energy Physics institutes from 31 countries¹ and by CERN. The experiment will be installed on the interaction Point 5 of the LHC at a depth of 90 m below ground.

The CMS magnet is the backbone of the CMS experiment [2], as all subdetectors will be supported from it. The magnet will be first assembled and tested in a surface hall (Figs. 2 and 3) then lowered in the underground area (Fig. 8) by heavy lifting means. This decouples the work on the magnet assembly and test from the construction of the underground area.

The return yoke is a 12-sided structure divided into three main components: the barrel yoke and the two endcap yokes. Its main parameters are given in Table I. The coil is an indirectly cooled, aluminum stabilized, four-layer superconducting solenoid. Its main parameters are given in Table II.

The coil is wound using the inner winding method, and the external mandrels are also used as quench-back cylinders providing passive protection. The coil is indirectly cooled by saturated helium at 4.5 K circulating in the thermosiphon mode through a network of pipes welded to the external mandrels.

II. ORGANIZATION OF THE CMS MAGNET PROJECT

A. Participating Institutes

The CMS magnet project can be grouped into three main headings comprising activities and systems:

¹Armenia, Austria, Belarus, Belgium, Bulgaria, China PR, China (Taiwan), Croatia, Cyprus, Estonia, Finland, France, Georgia, Germany, Greece, Hungary, India, Italy, Korea, Pakistan, Poland, Portugal, Russia, Slovak Republic, Spain, Switzerland, Turkey, Ukraine, United Kingdom, United States of America and Uzbekistan.

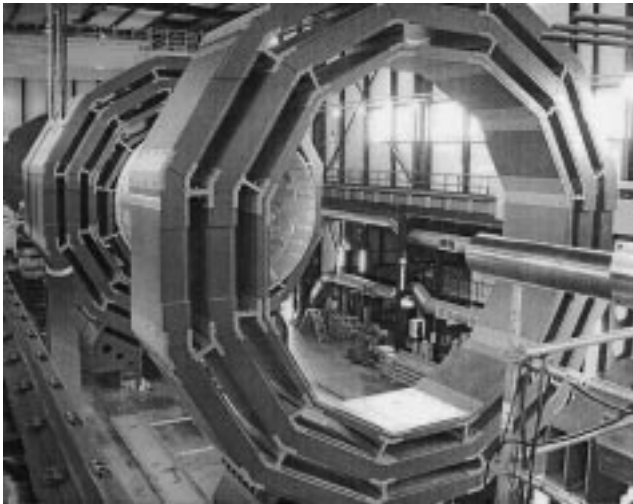

Fig. 2. Perspective view of the barrel yoke rings already assembled in the surface hall, showing pockets in which muon stations will be inserted. The outer vacuum tank, supported from the central barrel ring and destined to house the superconducting coil, also is visible.

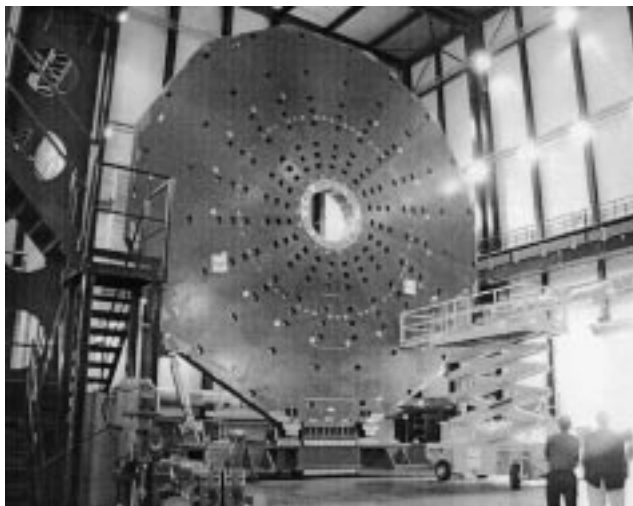

Fig. 3. View of one endcap disk (out of six) standing on a transport cart in the surface hall. This disk is 600 mm thick and weighs 700 tons.

TABLE I
MAIN PARAMETERS OF THE RETURN YOKE

General outer diameter on flats	14 m
Length of barrel	13 m
Thickness of iron layers in barrel	300, 630 & 630 mm
Mass of iron in barrel	6,000 tonnes
Thickness of disks in endcap	600, 600 & 250 mm
Mass of iron in each endcap	2,000 tonnes
Total mass of iron in return yoke	10,000 tonnes

- the yoke, consisting of the barrel, the vacuum tank and the two endcaps;
- the coil, consisting of the general engineering, the superconductor, and the coil winding;
- the ancillaries, consisting of the external cryogenics, the power converter and circuit, and the control system.

TABLE II
MAIN PARAMETERS OF THE COIL

Magnetic length	12.5 m
Free bore diameter	6 m
Radial thickness of cold mass	312 mm
Weight of cold mass	220 tonnes
Central magnetic induction	4 T
Maximum induction on conductor	4.6 T
Total ampere-turns	42.5 MA-turns
Nominal current	20 kA
Inductance	14 H
Stored energy	2.7 GJ

This structure is reflected in the organization of the CMS magnet project. The management and general coordination is done by a CERN-based group. Work is carried out in the institutes that are members of the CMS Magnet Collaboration, and in particular:

- CERN/CMS is in charge of the barrel yoke;
- University of Wisconsin and PSL are in charge of the endcap yokes in collaboration with CERN/CMS;
- Fermilab is in charge of procuring superconducting (sc.) strands and other conductor components, and also of the field mapping;
- CEA Saclay is in charge of the general engineering of the coil;
- ETH Zürich is in charge of the production of the conductor in collaboration with CERN/CMS and Fermilab;
- INFN Genova is in charge of the winding operation in collaboration with CERN/CMS;
- CERN Technical Groups are in charge of all ancillaries requiring future operation follow-up and site maintenance, such as: power converters, contactors, outer cryogenics, process control, etc.

B. Organization of the Procurements

As the Magnet Project is a common project of the CMS Collaboration, each CMS participating institute must contribute financially according to an agreed sharing. Each institute can participate in the procurement for the CMS Magnet in three ways:

- payment to contract: a participating institute places a contract directly with a supplier and finances it (or a group of institutes finances it);
- in-kind contribution: a participating institute delivers an item, and is credited for the market value of this item;
- common-fund contribution: a participating institute contributes directly to a common fund managed from CERN, and CERN issues contracts financed from this common fund.

In all cases, the technical specifications are issued by institute members of the Magnet Collaboration and endorsed by the Magnet Technical Board (MTB) under the responsibility of the CMS Magnet Project Manager. As a rule, Market Surveys

are conducted, through the CERN SPL Division, in all CERN member states and CMS participating countries.

III. THE RETURN YOKE

A. The Barrel Yoke

The barrel yoke was designed at CERN. It is split into five barrel rings, having each a mass of 1200 tons, which can move in the axial direction on heavy duty air-pads to give access to the barrel muon stations (Fig. 2).

A contract has been placed by ETH Zürich with the firm DWE (Degendorfer Werft und Eisenbau, Degendorf, Germany) for the construction of the barrel yoke and the vacuum tank. The 450 mm thick plates have been delivered by Izhora Zavov (St. Petersburg, Russia).

The support feet for the outer barrel rings have been manufactured, as an in-kind Pakistani contribution, by SES (Islamabad, Pakistan).

The final assembly of the barrel yoke has been performed at the CERN site by the consortium DWE/FCI, starting in July 2000 and finishing in July 2001.

B. The Endcap Yoke

Each endcap yoke, designed at the University of Wisconsin, is built from three independent disks (600-, 600-, and 250-mm thick) which can be moved on carts, supported by heavy-duty air pads, and separated to provide access to the forward muon stations and inner subdetectors (Fig. 3).

The disks are manufactured by KHI (Kawasaki Heavy Industries, Kobe, Japan) under a University of Wisconsin contract. The first endcap has already been assembled in the surface hall by FCI (Franc Comtoise Industrie, Lons le Saunier, France) in the surface hall, while the second one is expected to arrive at CERN mid-October 2001.

Assembly of the endcap yoke should be completed by the end of 2001, ready to receive the hadronic forward calorimeter.

The endcap carts have been manufactured as an in-kind Chinese contribution by HHM (Hudong Heavy Machinery, Shanghai, China).

IV. THE SUPERCONDUCTING COIL

A. Design of the Coil

The CMS coil design is based, as for a number of existing large detector superconducting solenoids, on the enthalpy stabilization concept. Important information have been gained from the previous designs, and in particular the ALEPH solenoid has been used in many ways as a reference model for the design of the CMS coil [3].

The main changes introduced for the CMS coil design are:

- a four-layer winding instead of a mono-layer one to provide the needed ampere-turns;
- a construction in five modules to allow transportation;
- a self-supporting-winding mechanical structure based on a mechanically reinforced conductor wound inside a thin mandrel to limit shear stresses in the insulation in spite of the large strain.

The design of the coil in five modules has been carried out at CEA Saclay, with a strong participation of INFN-Genova and ETH Zürich, and was completed at the end of 2000. An artist view of the coil is given on Fig. 4, and the detailed status of the coil design is reported in [4].

B. The Conductor

One of the first major decisions taken at the very beginning of the project was to reinforce the pure aluminum conductor by welding, on each side of the so-called pure aluminum insert which contains the Rutherford cable, two aluminum-alloy sections to react the magnetic force where it is created. This makes this component more complex than other aluminum-stabilized conductors previously used for thin solenoids. The cross section of the CMS conductor is shown in Fig. 5.

As the EB welding seams must be far enough from any sc. strand not to degrade it, the Rutherford cable has been limited to 32 strands for geometrical reasons, and thus the required current carrying capability of the strand has been pushed to the limit of what can be produced industrially, namely a j_c of 3074 Amm⁻² at 5 T and 4.2 K.

The general description of the conductor is reported in [5], and detailed reports on the components are given in [6] for the strands, [7] for the aluminum alloy reinforcement and in [8] for the EB welding operation.

Monitoring of conductor quality is of major importance for such a project. In particular, an ultrasonic scanning system has been developed at EMPA (Swiss Federal Laboratories for Materials Testing and Research, Dübendorf, Switzerland) to monitor the quality of the bonding during extrusion and the quality of the welds during the EB welding operation [9].

At the end of the manufacturing process, integral samples of conductor are measured (after removing the reinforcement) in the Marisa facility at Genova [10]; in addition, extracted strands are measured at Saclay. All these measurements confirm that, in the worse conditions, the total degradation does not exceed 7% with respect to the virgin wire.

The first 2.6-km length of real conductor destined to the winding prototype has just been produced.

The design and procurement of the conductor is a subcollaboration between CERN/CMS, Fermilab and ETH Zürich. The orders have been distributed as follows:

- sc strands: Fermilab, contract to Outokumpu (Pori, Finland); 60% have been delivered,
- pure aluminum billets: Fermilab, contract to Sumitomo chemical company Ltd. (Tokyo, Japan); delivery is completed,
- aluminum alloy sections: Fermilab, contract to Aluisse (Sierre, Switzerland); delivery is completed,
- cabling as Rutherford cable: ETH Zürich, orders to Kablewerk Brugg (Brugg, Switzerland); 10 (out of 21) good cables have been produced.
- co-extrusion of pure aluminum: ETH Zürich, contract to Nexans (Cortailod, Switzerland); 8 (out of 21) good inserts have been produced,
- electron Beam Welding of reinforcement sections: ETH Zürich, contract to Techmeta (Metz-Tessy, France); one (out of 21) real length has been produced.



Fig. 4. Perspective view of the CMS coil inside the vacuum tank showing the five modules, the tie-bar suspension system and the thermosiphon cooling circuits outside the mandrels.

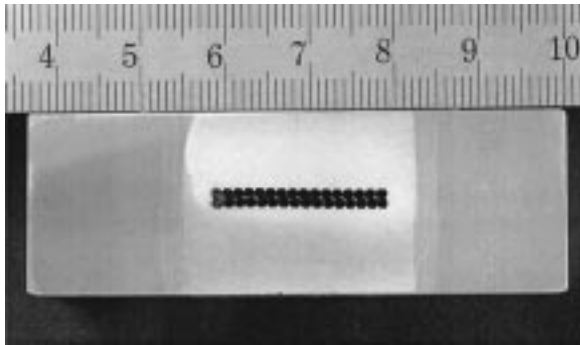

Fig. 5. Cross section of the CMS conductor. One can note the two aluminum alloy sections welded by Electron Beam welding technique to the central pure aluminum insert comprising the Rutherford 32-strand cable.

C. The Winding

The fact that the conductor is machined with precision on-line at the exit of the EB welding line makes it easy to wind. Nevertheless, a preindustrialization program has been carried out to understand the behavior of such a large reinforced conductor during the different phases of the winding. A final contract has been issued by INFN to Ansaldo (Genova, Italy); the winding machine is ready, and first turns using final conductor have been performed satisfactorily [11] (see Fig. 6).

The winding mandrels are an essential part of the cold mass, as they are used also for cooling and quench-back. High-mechanical-characteristic aluminum alloy has been retained. Pechiney (France) has delivered the thick plates; however, the flange sections are made from seamless aluminum rings produced by Dembiermont (Haumont, France) [12].

D. The Ancillaries

The coil will be cooled by helium circulating in the thermosiphon mode [13]. The 1.5-kW external cryogenics subsystem has been designed by the LHC Cryogenic group at CERN. The complete cryogenic system will run temporarily on the surface in 2002 for commissioning the refrigerator,



Fig. 6. View of the conductor during transfer inside the winding machine, when winding the first layers of the winding prototype.

and in 2004 for the test of the magnet. The contract for the outer cryogenics has been awarded by CERN to Air Liquide (Sassenage, France).

The bipolar power supply is located alongside the refrigerator cold box in the service cavern. It will deliver a current of 20 kA at a maximum ramping voltage of 22 V, implying a charging time of 4 h. There are two modes for slow discharging the coil current: 1) in normal operation discharge will be performed using the power supply, or 2) the current can be dumped into the resistor bank set at its lowest resistance value of 2 m Ω . The use of the bipolar power converter should minimize down time of the experiment, as the current will not have to be brought to zero each time the current has to be decreased.

In case of emergency, a fast discharge in a 30 m Ω resistor bank can be used; the time constant of the current decay is, in this case, 190 s. Dump resistors have been positioned on the surface, at 150 m from the coil, to minimize thermal disturbances in the experimental cavern.

The Magnet Control System is designed by the CERN EP Division in collaboration with Saclay. Its main feature is to distinguish with high reliability the fault situation, requiring a fast dump, from less severe fault conditions for which initiation of a slow discharge is sufficient. This is to minimize the time lost for physics for CMS; one has to consider that, due to the large stored energy, more than three days will be necessary for re-cooling the coil down to 4.5 K after a fast dump.

V. ASSEMBLY OF THE COIL AND EXPERIMENTAL AREA

It has been chosen to assemble and test the magnet in a large surface hall (23.5 m high, that will be reduced later to 16 m) before lowering it into the underground experimental cavern situated at a depth of 90 m.

The coil will be supported from the external vacuum tank by a set of tie bars of titanium alloy. Details of the suspension system are reported in [14], and the comparison between possible alloy grades is reported in [15].

The insertion of the coil inside the vacuum tank will be performed in the surface hall using large dedicated tooling that has been manufactured by Doosan Heavy Industries (Chang-Won, Korea); the assembly procedure is described in [4], and one phase can be seen in Fig. 7.

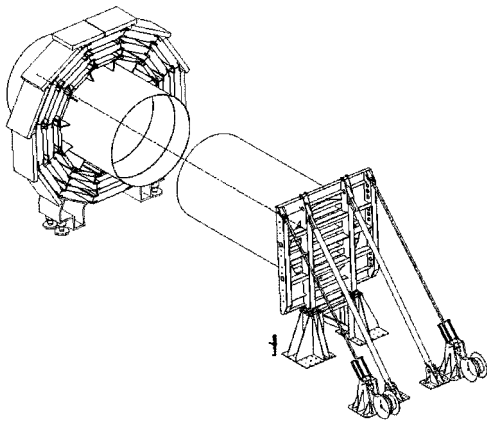

Fig. 7. Perspective view of the insertion of the coil, maintained in a cantilevered position, inside the outer vacuum tank; the central barrel ring assembly, comprising the outer vacuum tank, will slide toward the coil using heavy duty air-pads.

As shown in Fig. 8, heavy lifting means will have to be used, as the heaviest part to be handled will weigh nearly 2000 tons.

The 20.4 m diameter shaft, giving access to the experimental cavern, will be separated from the surface hall by a 1800-ton mobile radiation shielding plug, which will also be used as support structure for the transfer of the magnet elements to the experimental cavern (see also Fig. 8).

The magnet will be lowered into the underground experimental cavern in 11 large pieces (5 barrel yoke rings, and 6 endcap disks) weighing from 500 to 2000 tons.

The experimental cavern has a diameter of 26.5 m and a length of 53 m. These are the minimum dimensions to open the CMS magnet and handle the major components. The experimental cavern is separated from the service cavern by a shielding wall 7-m thick. In the service cavern will be situated the power converter, the contactors and the cold box. Transfer lines and bus bars will cross the shielding wall at an angle, and the service cavern will be always accessible, even when the LHC collider will run at the highest luminosity.

VI. COST ESTIMATE

The total cost of the CMS magnet was estimated at the start of the project to be 122.3 MCHF, in 1995 prices, and today 86% has been spent or committed. The major barrel and endcap contracts have generally cost slightly below estimate; however, ancillary equipment has generally cost more. In addition, 2 MCHF more has been used for the conductor manufacture and for producing more test lengths to commission the various production lines; also 1 MCHF more has been allocated to the heavy lifting operation, and 0.6 MCHF is being kept in reserve.

During a recent financial review of the project, the cost to complete the CMS Magnet Project has been estimated at 21 MCHF, bringing the total cost estimate, in current prices, at 125.4 MCHF, an increase of 1.5%, the present breakdown being 49 MCHF for the return yoke, 69 MCHF for the coil and its ancillaries, and 7.4 MCHF for the transfer and installation underground.

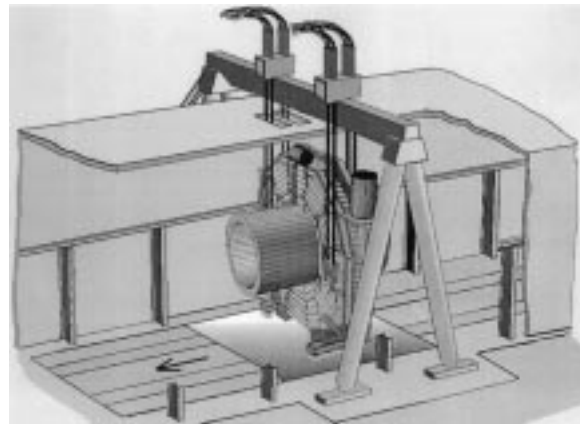

Fig. 8. Perspective view of the lifting of the central barrel ring supporting the cantilevered vacuum tank containing the coil equipped with valve box and 6000 l dewar. The assembly shown here weighs 2000 tons.

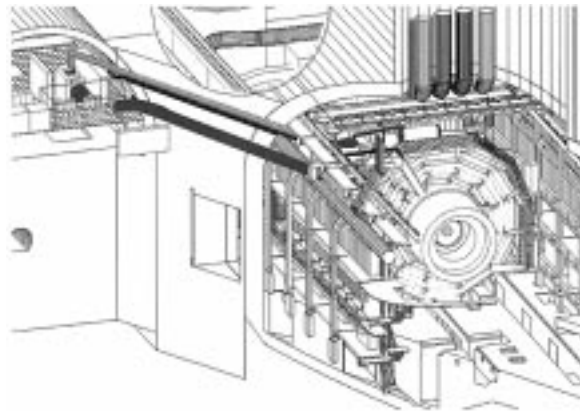

Fig. 9. Perspective view of the CMS magnet inside the experimental cavern; the bus bar and transfer line connections to the power supply and cold box in the service cavern cross the 7-m-thick shielding wall.

VII. CONCLUSION

The CMS magnet project is in construction, in full compatibility with the design of the subdetectors.

The experimental area, which is mainly constrained by the magnet requirements, is in construction and will be accessible only in mid-2004. For this reason the magnet will be first assembled, then tested, in the surface hall in mid-2004, before being transferred into the underground area by heavy lifting means.

The surface hall has been delivered in mid-2000, allowing assembly to start. The construction of the barrel yoke is finished, and assembly of the endcap yoke is well advanced.

The first 2.6-km length of conductor has just been produced; winding of first turns of final conductor using the final winding machine has started in July 2001, and winding of the first coil module is scheduled for early 2002. The five coil modules should be assembled in the surface hall for the end of 2003.

ACKNOWLEDGMENT

The authors would like to thank the members of the CMS Magnet Collaboration for their dedicated work, as well as the CMS collaboration for its constant support. A special mention goes to the ST, EST, and LHC divisions of CERN for their invaluable support.

REFERENCES

- [1] CMS Collaboration, "The compact muon solenoid: Technical proposal," CERN, Europ. Lab. for Particle Phys., volume CERN/LHCC 94-38, LHCC/P1, Dec. 15, 1994.
- [2] CMS Magnet Collaboration, "The magnet project: Technical design report," CERN, Europ. Lab. for Particle Phys., volume CERN/LHCC 97-10, CMS TDR 1, 1997.
- [3] H. Desportes *et al.*, "Design construction and test of the large superconducting solenoid ALEPH," *IEEE Trans. Magnetics*, vol. 24, pp. 1260–1263, Mar. 1988.
- [4] F. Kircher, Ph. Brédy, D. Campi, P. Fabbriatore, S. Farinon, H. Gerwig, A. Hervé, I. L. Horvath, B. Levesy, R. Musenich, Y. Pabot, A. Payn, and L. Veillet, "CMS coil design and assembly," *IEEE Trans. Appl. Superconduct.*, submitted for publication.
- [5] B. Blau, D. Campi, B. Curé, R. Folch, A. Hervé, I. L. Horvath, F. Kircher, R. Musenich, J. Neuenschwander, P. Riboni, S. Sgobba, S. Sequeira Tavares, and R. P. Smith, "The CMS conductor," *IEEE Trans. Appl. Superconduct.*, submitted for publication.
- [6] B. Curé, B. Blau, D. Campi, L. F. Goodrich, I. L. Horvath, F. Kircher, R. Liikamaa, J. Seppälä, R. P. Smith, J. Teuho, and L. Vieillard, "The superconducting strand for the CMS solenoid conductor," *IEEE Trans. Appl. Superconduct.*, submitted for publication.
- [7] S. Sequeira Tavares, B. Blau, D. Campi, B. Curé, I. L. Horvath, P. Riboni, S. Sgobba, and R. P. Smith, "Aluminum alloy production for the reinforcement of the CMS conductor," *IEEE Trans. Appl. Superconduct.*, submitted for publication.
- [8] R. Folch, B. Blau, D. Campi, R. Christin, J. P. Créton, B. Curé, A. Hervé, I. L. Horvath, J. Neuenschwander, P. Riboni, S. Sequeira Tavares, and S. Sgobba, "Continuous EB welding of the reinforcement of the CMS conductor," *IEEE Trans. Appl. Superconduct.*
- [9] J. Neuenschwander, B. Blau, I. L. Horvath, Th. Lüthi, and H. P. Marti, "Bond and electron beam welding quality control of the aluminum stabilized and reinforced CMS conductor by means of ultrasonic phased-array technology," *IEEE Trans. Appl. Superconduct.*
- [10] M. Greco, P. Fabbriatore, and R. Musenich, "Critical current measurements on the CMS stabilized conductor," *IEEE Trans. Appl. Superconduct.*, submitted for publication.
- [11] P. Fabbriatore, D. Campi, C. d'Urzo, S. Farinon, A. Gaddi, B. Levesy, L. Loche, R. Musenich, F. Rondeaux, R. Penco, and N. Valle, "The winding line for the CMS reinforced conductor," *IEEE Trans. Appl. Superconduct.*, submitted for publication.
- [12] S. Sgobba, C. d'Urzo, P. Fabbriatore, S. Farinon, A. Gaddi, A. Lauro, B. Levesy, L. Loche, R. Musenich, F. Rondeaux, S. Sequeira Tavares, and N. Valle, "Design, construction and quality tests of the large al-alloy mandrels for the CMS coil," *IEEE Trans. Appl. Superconduct.*, submitted for publication.
- [13] D. Delikaris, J. P. Dauvergne, G. Passardi, J. C. Lottin, J. P. Lottin, and Ch. Lyraud, "The cryogenic system for the superconducting solenoid magnet of the CMS experiment," in *Proc. 15th Int. Conf. Magnet Technol., MT-15*. Beijing 100 717, China: Science 1998, Oct. 20–24, 1997, pp. 1230–1233.
- [14] B. Levesy, H. Gerwig, F. Kircher, and M. Reytyer, "Design and test of the titanium alloy tie rods for the CMS Coil suspension system," *IEEE Trans. Appl. Superconduct.*, submitted for publication.
- [15] M. Reytyer, F. Kircher, and B. Levesy, "Characterization of titanium alloys for cryogenic applications," in *Cryogenic Engineering Conf., CEC'01*, Madison, WI, USA, July 16–20, 2001, submitted for publication.