

# MEASUREMENT OF THE BEAM POSITION IN THE TESLA TEST FACILITY LINAC

R. Lorenz, TU Berlin, Einsteinufer 17, 10587 Berlin, Germany,  
M. Sachwitz, H.J. Schreiber and F. Tonisch, DESY-IfH Zeuthen, Germany

## Abstract

The transverse beam position has to be measured at each superconducting quadrupole in the TESLA Test Facility Linac with a resolution of better than  $10 \mu\text{m}$ . Therefore, a cylindrical cavity excited in the  $\text{TM}_{110}$ -mode by an off-center beam was chosen, also because of the limited longitudinal space and the cold environment. The amplitude of the  $\text{TM}_{110}$  and its phase with respect to a 1.517 GHz reference signal are measured in a homodyne receiver. For the experimental area, stripline monitors having a resolution of better than  $100 \mu\text{m}$  were developed. The averaged position of the whole bunch train of Injector I is measured using the amplitude-to-phase conversion. This paper summarizes the designs and some 'beam position measurements' in the laboratory.

## Introduction

In order to establish a technical basis for a superconducting linear collider, the TESLA Test Facility is an essential part of the development of injectors, accelerating cavities, cryostat and new diagnostic techniques [1].

Because of special requirements three different types of beam position monitors will be used in the TTF: Buttons (Injector I), cylindrical cavities (inside the cryostats, attached to the quadrupoles) and striplines (experimental area). The purpose of this note is to discuss the cavities and the striplines, to describe the electronics, and to present measurement results on both types. Unfortunately, due to the delay in the installation of other components we still do not have any operating experience.

## $\text{TM}_{110}$ -Cavity

For the alignment of the quadrupoles a single circular cavity was designed because of the limited longitudinal space and the desired resolution of  $10 \mu\text{m}$  in a cold environment. The amplitude of the  $\text{TM}_{110}$ -mode excited by the beam in the cavity yields a signal proportional to the beam displacement and the bunch charge. Its phase relative to an external reference gives the sign (up/down, left/right). Both  $\text{TM}_{110}$ -polarizations have to be measured to get the x- and y-offset. After cooling down, the seventh harmonic of 216.7 MHz has to be within the  $\text{TM}_{110}$ -bandwidth to avoid an active tuning system inside the cryostat. The antennae are replaceable to allow a pre-tuning by adjusting the coupling before cooling down.

In addition, two ('warm') cavities working at room temperature were built. Their temperature is stabilized in a thermostat and can be changed to tune the monitor slightly (about 20 kHz/K).

In both cases CrNi was chosen as the cavity material to measure individual bunches spaced at  $1 \mu\text{s}$  (Injector II). Most of the parameters given in Table I were calculated with URMEL, whereas the resonant frequencies and the coupling factors were measured at room temperature.

Table 1: Design and measured parameters (at 25 °C).

parameter	'cold' cavity	'warm' cavity
cavity radius $R_0$	115.2 mm	117.0 mm
cavity length $l$	52.0 mm	52.5 mm
beam pipe radius	39.0 mm	29.75 mm
loss factor $k_{110}$	0.24 V/pC	0.23 V/pC
unloaded $Q_{110}$	2965	3025
frequency $f_{110}$	1.513 GHz	1.517 GHz
coupling $\beta_{110}$	1.31	0.95
coupling $\beta_{010}$	0.1	0.09

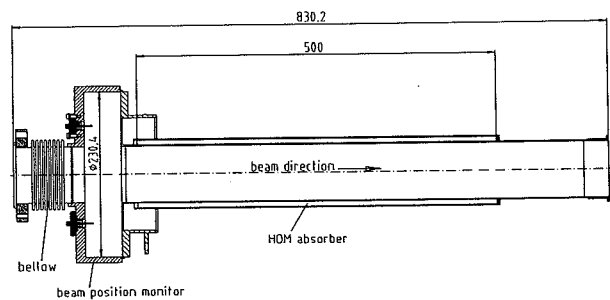

Figure 1: Cavity BPM with HOM absorber.

Since the field maximum of the common modes is on the cavity axis, they will be excited much stronger than the  $\text{TM}_{110}$  by a beam near the axis. The estimated resolution near the electrical center is only  $60 \mu\text{m}$ , due to residual signals even at  $\omega_{110}$ . This can be reduced by combining two opposite outputs in a field selective filter [2]. Because of the limited space inside the cryostat, a stripline hybrid was used outside. The rejection of common field components is limited by its finite isolation between the  $\Sigma$ - and the  $\Delta$ -port; an isolation of 20 dB brings the theoretical resolution down to less  $6 \mu\text{m}$ . In addition, a frequency sensitive  $\text{TM}_{010}$ -rejection of about 69 dB is required to detect a beam displacement of  $10 \mu\text{m}$ .

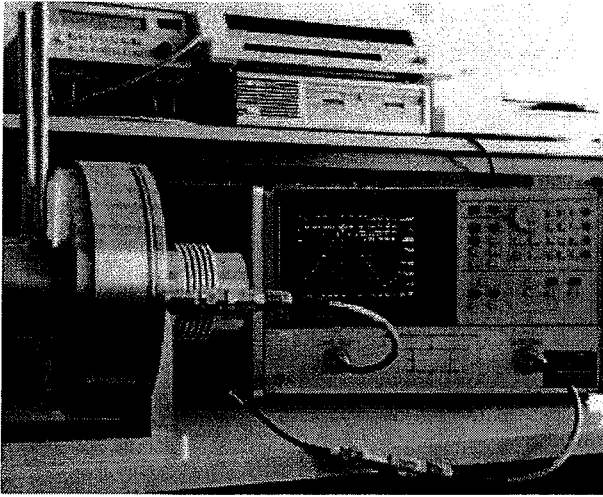

Figure 2: Test of a cavity BPM using a Network Analyzer.

The resolution near the electrical center of the cavity is limited by the thermal noise of the electronics, too. Assuming a cavity without perturbations and a bunch charge of 32 pC, a S/N-ratio of 140 can be estimated for a beam offset of 1  $\mu\text{m}$  from the cavity center [2].

### Signal processing

The  $\text{TM}_{110}$ -amplitude is detected in a homodyne receiver by mixing the cavity output and a reference signal down to DC (Fig. 3). When the beam is on the right, the system can be set up to give positive video polarity. The signal changes the phase by  $180^\circ$  when the beam moves to the left, and for a centered beam it becomes zero.

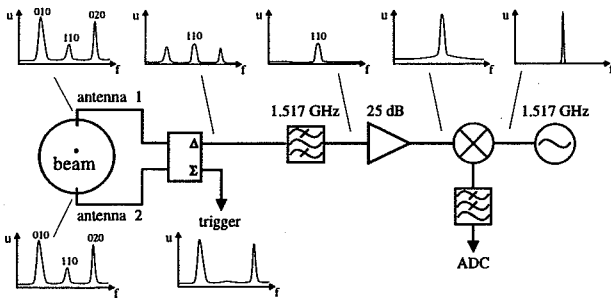

Figure 3: Signal processing scheme for a cavity BPM.

The stopband attenuation of the bandpass filter is more than 70 dB. Together with the hybrid and the coupling factors this gives a frequency sensitive common mode rejection of about 100 dB. Because of the isolation of the hybrid and between both  $\text{TM}_{110}$ -polarizations, the full aperture was divided into two measurement ranges.

By using a Quadrature IF Mixer, no additional phase stabilization for the reference is needed. The mixer LO/RF-isolation

determines the dynamic range of the electronics. After passing low-pass filters and bipolar video amplifiers, the signal may be either viewed directly on an oscilloscope for adjustment, or digitized by 12-bit ADCs for the quadrupole alignment.

### Test results

Bench tests were carried out on a stainless steel prototype to determine the resolution near the center and to test the electronics. Therefore, the cavity was excited by an antenna, fed by a network analyzer. A resolution of about 5  $\mu\text{m}$  was measured in the frequency domain [2].

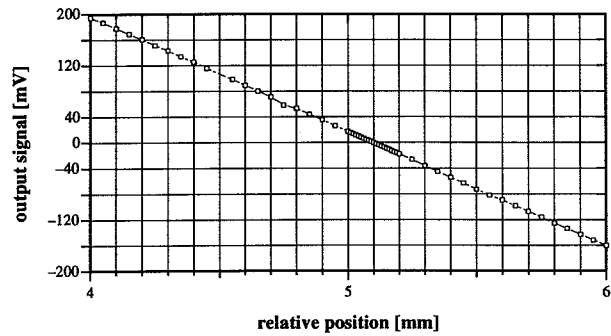

Figure 4: Measured linearity for the electronics.

In addition, a prototype was tested at the CLIC Test Facility (CERN) to demonstrate the principle single bunch response and to measure the  $\text{TM}_{110}$ -amplitude as a function of the relative beam displacement. The BPM was installed in the spectrometer arm and the beam was moved vertically by changing the current of the steering coil.

A 250 MHz signal from the timing system was fed to a step recovery diode and the 6th harmonic was mixed with the  $\Delta$ -signal. The output of the electronics vs. the relative beam position is shown in Fig. 5. Due to the measurement position, the mechanical setup and some machine parameters it was not possible to measure the minimum detectable signal near the center.

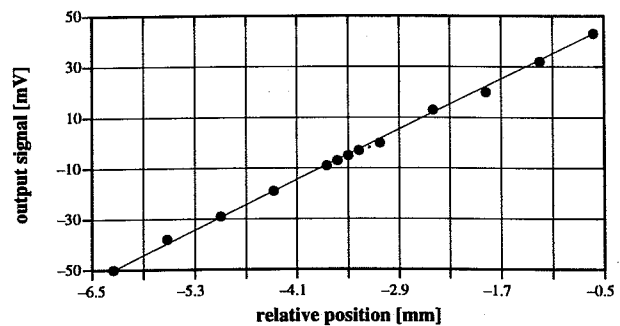

Figure 5: Test at CTF - output versus rel. position.

## Stripline Monitors

Stripline monitors were selected for the experimental area and a temporary beamline because of the relaxed requirements - 100  $\mu\text{m}$  resolution around the center - and the warm location. All monitors consist of four 50  $\Omega$  coaxial striplines, positioned 90 degrees apart in azimuth (Fig. 6). The housing for the one in the dipole arm has a larger beam pipe diameter (100 mm instead of 60 mm).

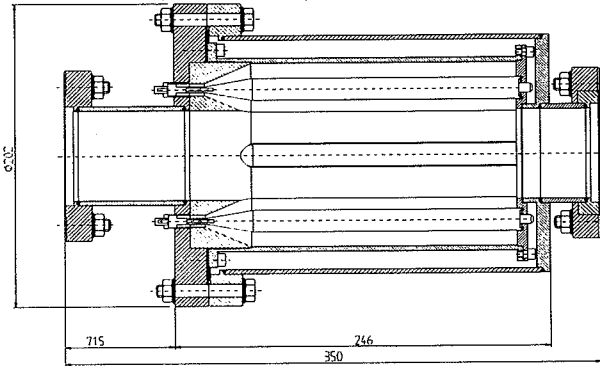

Figure 6: Design of the Stripline BPM.

The BPM body is machined from a single block of stainless steel, four holes and the beam aperture are drilled. Each electrode is 175 mm long and shortened at the end; the geometrical coupling factor is approximately 3%. The main distortion in the transition from the electrode into the cable is caused by the feedthrough, selected for mechanical reasons. All 9 monitors were built and tested at DESY-IfH Zeuthen.

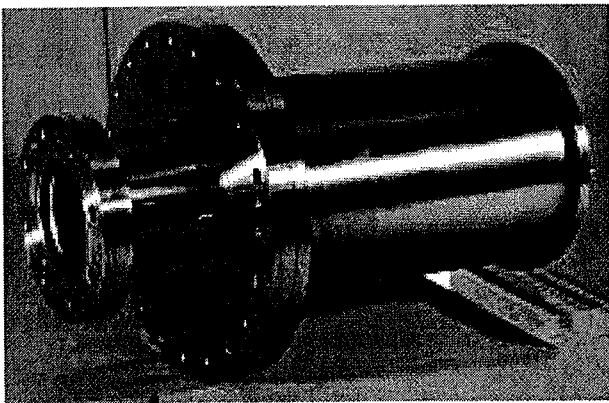

Figure 7: Stripline monitor, vacuum cover removed.

The electronics to detect the  $\frac{\Delta}{\Sigma}$ -signal of two opposite electrodes were built and tested (signals, linearity, drift) by INFN-LNF [3]. Since the signal has to be measured on a time scale of a few microseconds, the usage of a single channel for all electrodes and a multiplexing scheme was impossible. Hence, the signal processing is done in the frequency domain by using the

amplitude-to-phase conversion scheme together with heterodyning (intermediate frequency of 50 MHz). The generation of a normalized output (position vs. current) over a wide dynamic range is the main advantage of this system. Furthermore, it is relatively insensitive to electromagnetic noise.

A peak-to-peak noise of less than 4 mV was measured, corresponding to a position resolution of about 40  $\mu\text{m}$ . This agrees very well with bench test results, where the position of a thin wire was changed until the first 'significant' readout of the electronics was detected (see also Fig. 8, from [4]). The whole system (monitor and electronics) gives a linear response for off-center positions up to 5 mm.

All monitors and the first electronics module are now at DESY Hamburg, awaiting a real beam.

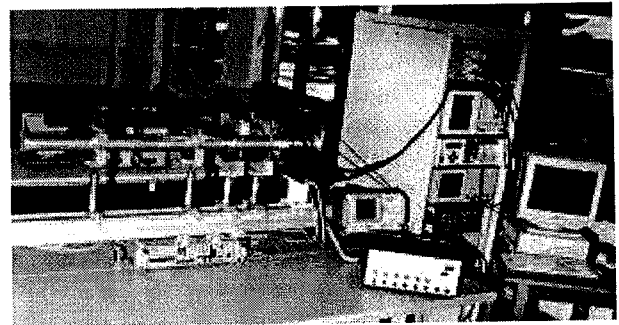

Figure 8: BPM test-stand at DESY-IfH Zeuthen.

## Acknowledgements

It is a pleasure to thank our colleagues from INFN Frascati, especially P. Patteri, for developing, building and testing the stripline electronics. Finally, we acknowledge the technical support from DESY-IfH Zeuthen and from BESTEC Berlin-Adlershof.

## References

- [1] H. Weise, "The TESLA Test Facility Linac - a Status Report", in IEEE Conference Proceedings of the PAC 95, Dallas, May 1995, pp. 677-679.
- [2] R. Lorenz, "Beam Position Monitors in the TESLA Test Facility Linac", in IEEE Conference Proceedings of the PAC 95, Dallas, May 1995, pp. 2631-2633.
- [3] M. Castellano et al., "TESLA Test Facility Stripline Readout System", to be published in Conference Proceedings of the EPAC 96, Barcelona, June 1996.
- [4] A. Hennig, Diplomarbeit, Fachhochschule f. Technik und Wirtschaft Berlin, October 1995.