

SRRC/ANL HIGH CURRENT L-BAND SINGLE CELL PHOTOCATHODE RF GUN

C.H. Ho, T.T. Yang, J.Y. Hwang, G.Y. Hsiung, S.Y. Ho, M.C. Lin
Synchrotron Radiation Research Center, No.1 R&D Road VI, Hsinchu 30077, Taiwan
M. Conde, W. Gai, R. Konecny, J. Power, P. Schoessow
Argonne National Laboratory, 9700 S. Cass Avenue, Argonne, Illinois 604

The submitted manuscript has been created by the University of Chicago as Operator of Argonne National Laboratory ("Argonne") under Contract No. W-31-109-ENG-38 with the U.S. Department of Energy. The U.S. Government retains for itself, and others acting on its behalf, a paid-up, nonexclusive, irrevocable and exclusive license in said article to reproduce, prepare derivative works, distribute copies to the public, and perform publicly and display publicly, by or on behalf of the Government.

Abstract

A high current L-band photocathode rf gun is under development at SRRC (Synchrotron Radiation Research Center, Taiwan) in collaboration with ANL (Argonne National Laboratory, USA). The goal is to produce up to 100 nC charge with the surface field gradient of over 90 MV/m at the center of the photocathode. In this report, we present the detailed design and initial test results. If successful, this gun will be used as the future AWA (Argonne Wakefield Accelerator)[1] high current gun.

1 INTRODUCTION

The generation of high gradients (> 100 MV/m) in wakefield structures requires a short pulse, high intensity electron drive beam. The goal of the AWA is to demonstrate high gradient and sustained acceleration of charged particle beam by using wakefield method. The main technological challenge of the AWA program is the development of a photo injector capable of fulfilling these requirements. The laser photocathode source was designed to deliver 100 nC bunches at 2 MeV to the drive linac. The photocathode gun is a single cell standing wave cavity with designed peak field of 90 MV/m on the cathode[2]. At present, the AWA drive beam properties are diagnosed at the exit of the drive linac, instead of the gun exit.

A joint collaboration between SRRC and ANL has been established to construct an L-band single cell photocathode rf gun and associated test stand. The goals of this collaborative research effort are to characterize the drive beam immediately after the gun exit, and to study the field breakdown phenomenon, dark current, and various photocathode materials.

2 FABRICATION AND COLD TEST

The gun cavity structure is shown in Figure 1. The cooling channel is built inside the cavity body instead of just attaching it on the outer surface. The cavity is also equipped with a tuner and a field probe.

The cavity was CNC machined several times to reach the correct resonant frequency and critical coupling. The cavity surface (mounted on a rotating stand) was then

Submitted to the proceedings of the 6th European Particle Accelerator Conference, EPAC-98, Stockholm, SWEDEN, June 22-26, 1998.

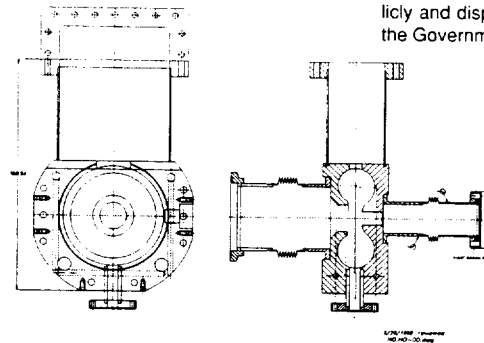

Figure 1: Assembly drawing of the gun cavity.

polished by the 3M Imperial Lapping Films (60, 40, 30, 15, 12, 9, 5, 3, and 1 micron) and the Buehler Micropolish II Alumina Suspensions (1, 0.3 and 0.05 micron).

The cavity components were brazed together in a vacuum furnace in several stages to allow the joints of various components. After brazing and applying the Vac Seal for possible small leaks around the joints between WR-650 waveguide and the cavity, it was vacuum tested using a Helium leak detector (Balzers HLT 160) and found to be Helium leak tight to better than 10^{-10} standard c.c./sec. However, it was found that the resonant frequency had been shifted down by 2.5 MHz and the

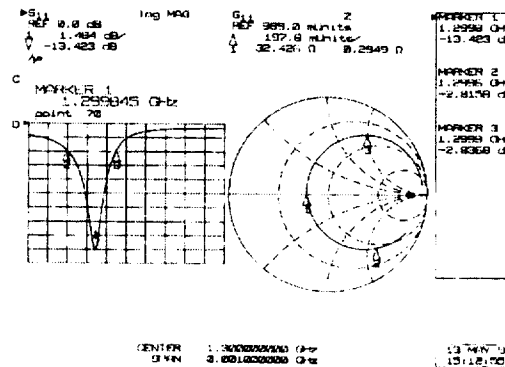
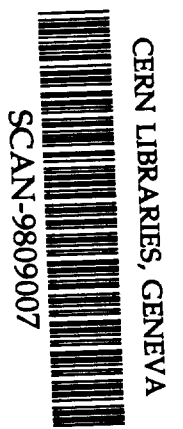

Figure 2: Measured reflection coefficient of gun cavity.



swg836

coupling coefficient shifted from 1 (critical coupling) to around 1.5 (over coupled). The frequency shift is corrected back to 1.3 GHz using the tuner. Figure 2 is the measured plot in atmosphere and room temperature from the HP 8510C network analyzer after the cavity is installed and tuned at ANL. The measured unloaded quality factor is around 13000. The URMEL prediction for the unloaded quality factor is around 15000.

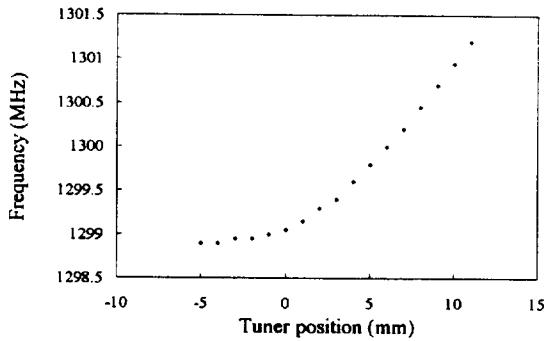

Figure 3: Measured resonant frequency to the tuner position.

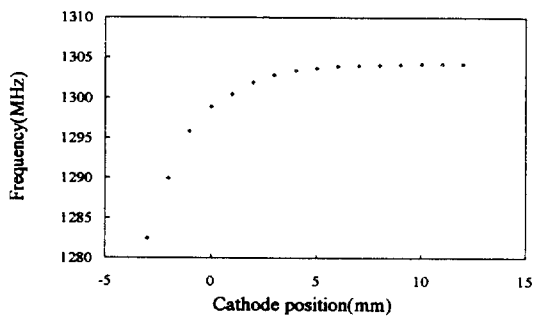

Figure 4: Measured resonant frequency to the cathode plug position.

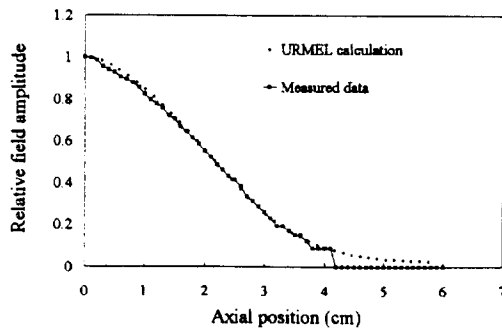

Figure 5: Longitudinal E-field profile on axis.

Figure 3 shows the measured frequency response to the tuner position (tuning rate is around 1.8 MHz/cm) and the frequency response to the cathode plug position (tuning rate is around 3 MHz/mm) is shown in Fig. 4. Since the

frequency is very sensitive to the cathode position, we use the tuner to fine tune the frequency. The cathode is held flush with the cavity inner surface to avoid arcing due to discontinuity.

A ceramic bead of 2 mm diameter was used to perform the bead pull measurement. Figure 5 shows the longitudinal E-field profile along the central axis of the cavity from the bead pull measurement results and the URMEL prediction.

A pair of solenoids were also designed, constructed and measured at SRRC. The measured magnetic field profile is in close agreement with the POISSON calculation, as shown in Fig. 6.

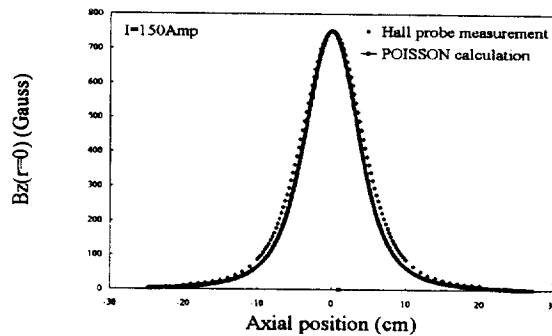

Figure 6: Longitudinal solenoid field profile on axis.

3 EXPERIMENTAL SETUP

The layout of the L-band rf gun test stand is shown in Figure 7. The whole system was first assembled and vacuum tested at SRRC and then shipped and installed at ANL, by SRRC and ANL staff in May, 1998. Two Molecular Drag pumps (16 CFM) and two oil free magnetic suspension Turbo Molecular Pumps (400 l/s) were used for roughing and baking (to 150 °C). Two sputtering ion pumps (60 l/s) and one Non-Evaporable Getter (NEG) pump (500 l/s) were used to reach a base pressure of around 1.6 nTorr and maintain the pressure at around 13 nTorr during conditioning of the cavity.

Layout of the L-Band(1.3GHz) RF Gun Test Stand

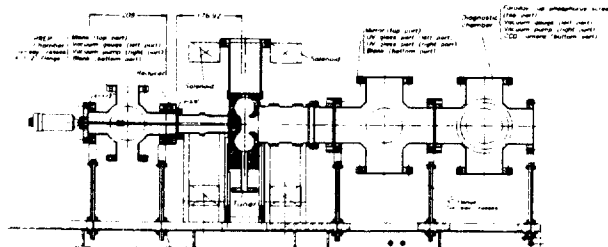

Figure 7: Layout of the L-band rf gun test stand.

4 INITIAL HIGH POWER TEST RESULTS

RF conditioning of the gun was proceeded smoothly. During the conditioning, the vacuum was kept under 50 nTorr and the occurrences of breakdown were kept to minimum. The forward, reflected rf power and dark current were also monitored continuously. Figure 8 shows the forward power to the gun with peak power of 2 MW. Figure 9 gives the reflected rf power and it shows that almost no detuning of the gun due to the dark current.

In fact, because this gun was over coupled after brazing, the loading from the dark current will help it to go toward critical coupling to some extent. Since the field monitor was not available yet for this test, one can only estimate the surface field using the rf reflection coefficient and dark current. For 2 MW forward power with no reflection, we have estimated the surface field at cathode center to be at 100 MV/m [2]. This is above our designed value of 92 MV/m. Figure 10 shows the dark current transported out of gun versus the surface field. It clearly shows the exponential dependence of the surface field. Below 70 MV/m, no significant dark current was observed. However, it goes up quickly as the surface field increases. At 100 MV/m, dark current is about 13 nC per rf pulse, in comparison with the original AWA gun which is 40 -60 nC at ~ 60 MV/m.

Further rf conditioning is required to further reduce the dark current and to attain higher axial electric field. This will be performed in the near future.

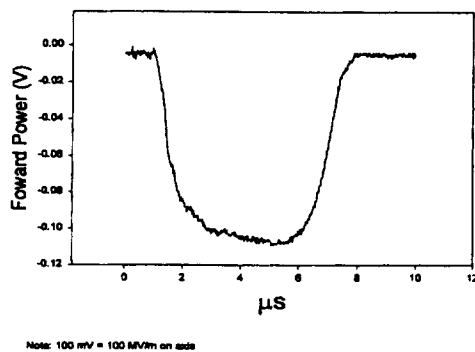

Figure 8: Measured forward rf power to the gun. The voltage measures 2 MW rf peak power.

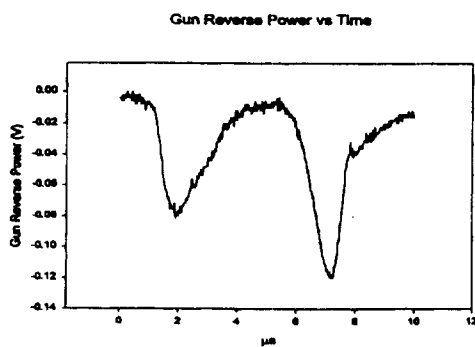

Figure 9: Reflected rf power from the gun. It shows that

after the gun was filled, no reflection was observed.

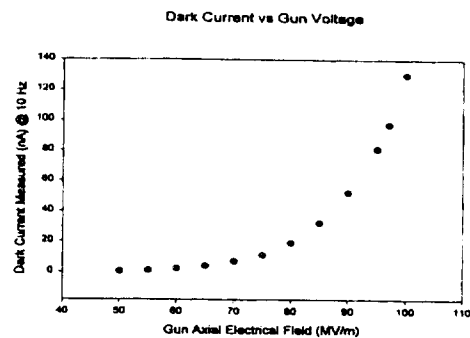

Figure 10: Measured dark current at the down stream against the surface field. It shows the exponential dependence and the maximum dark current observed was 13 nC at 100 MV/m.

5 SUMMARY

The first L-band rf gun cavity resulting from the joint collaboration between SRRC and ANL are constructed, installed and conditioned. The high power test results are very encouraging. Input rf power was applied to the resonant cavity from 100 KW level to 2 MW level within two days. Accelerating gradient in excess of 100 MV/m on the center of cathode was verified. The dark current measurement results show little effect of beam loading at this power level.

Further rf conditioning will be done in the near future to further reduce the dark current and increase the surface field to 120 MV/m, which will significantly improve the performance of AWA.

6 ACKNOWLEDGMENTS

We would like to thank Mr. T.T. Wu from ITRI for operating the vacuum brazing furnace. We would also like to thank Mr. M.H. Huang and Mr. C.H. Chang of SRRC for helping the construction of the solenoid, and Mr. F.Y. Lin and Dr. C.S. Hwang of SRRC for helping the measurement of the solenoid field profile. We would also like to thank the kind help from Mr. V. Svirtun, Mr. R. Nielson, and Dr. J. Noonan of ANL-APS, and Mr. R. Taylor of ANL-HEP during installation of the gun. This work is supported in part by the National Science Council (Taiwan) under contract No. NSC 87-2613-M-213-012, as well as by the Department of Energy (USA), Division of the High Energy Physics, Contract No. W-31-109-ENG-38.

7 REFERENCES

- [1] W. Gai et. al., in AIP Conf. Proc. 398 for the 7th Workshop on Advanced Accelerator Concepts Oct. 12-18, 1996, Lake Tahoe, California, p.116.
- [2] C.H. Ho, PhD Thesis, UCLA, 1992.

