

DD



STATE RESEARCH CENTER OF RUSSIA
INSTITUTE FOR HIGH ENERGY PHYSICS



sw9730

IHEP 96-106

V. Abramov, P. Goncharov, A. Gorin, A. Gurzhiev, A. Dyshkant,
V. Evdokimov, V. Kolosov, A. Korablev, Yu. Korneev, A. Kostritskii,
A. Krinitsyn, V. Kryshkin, V. Podstavkov, V. Polyakov, A. Shtannikov,
S. Tereschenko, L. Turchanovich, A. Zaichenko

**HADRON CALORIMETER WITH SCINTILLATORS
PARALLEL TO BEAM**

Submitted to *IET*

Protvino 1996

Abstract

Abramov V., Goncharov P., Gorin A. et al. Hadron Calorimeter with Scintillators Parallel to Beam: IHEP Preprint 96-106. – Protvino, 1996. – p. 8, figs. 8, refs.: 3.

A hadron calorimeter in which scintillators are arranged nearly parallel to the incident particle direction and light is collected by optical fibres with WLS has been built. The iron absorber plates are of the tapered shape to fit a barrel structure of the collider geometry. The performance of the calorimeter studied with hadron beam is presented as a function of tilt angle without and with electromagnetic calorimeter in front of the hadron one.

Аннотация

Абрамов В.В., Гончаров П.И., Горин А.М. и др. Адронный калориметр со сцинтиллятором, расположенным параллельно пучку: Препринт ИФВЭ 96-106. – Протвино, 1996. – 8 с., 8 рис., библиогр.: 3.

Изготовлен адронный калориметр, в котором пластины сцинтиллятора расположены параллельно направлению падающих частиц и свет собирается оптическими волокнами со сместителем спектра. Стальные пластины поглотителя имеют клинообразную форму, которая соответствует цилиндрической структуре коллайдерных установок. Характеристики детектора с непрерывно изменяющимся по глубине сэмпингом изучены на адронном пучке при отсутствии и при наличии электромагнитного калориметра перед адронным и представлены как функция угла наклона детектора.

Introduction

In [1] a novel electromagnetic calorimeter design has been proposed which is simple to construct, easy to assemble, has self-supporting structure and no dead space. Several electromagnetic calorimeters of such type were constructed and tested [2]. In this paper we describe a hadron calorimeter of the similar design discussed in [3]. The constructed calorimeter with varying sampling has fully projective structure corresponding to the collider geometry. The main goal of the study was to prove the principal points: characteristics of the calorimeter with varying sampling, the calorimeter response in dependence on the particles' hit angle with/without electromagnetic calorimeter in front of the hadron one.

1. Calorimeter construction

The geometry of the hadron calorimeter (HCAL) is illustrated in Fig.1. It consists of the tapered iron plates joint together by spacers and bolts. In the 3 mm gaps between the absorber plates the scintillators with WLS fibres are inserted. The front cross section of the calorimeter is $40 \times 39 \text{ cm}^2$ and the back side has dimensions $60 \times 61 \text{ cm}^2$. The four sides of the calorimeter are tapered to an angle of 12° . The length of the calorimeter is 100 cm, which corresponds to an overall thickness of about $5\lambda_{int}$.

Fig.2a shows the iron plate used in the calorimeter. From one end to another the thickness of the plate increases from 15 to 25 mm. With the change of the absorber thickness (variation of sampling) the response along the scintillators must change. The extruded scintillator 2 mm thick (Fig.2b) is used in the calorimeter. To minimize the space occupied by the photodetector at the back side of HCAL, the cut in scintillator had a radial shape in the region, where fibres were coming out of plate. The WLS fibres doped with K27 are of 1 mm diameter (one end of each fibre is covered with white paint). The scintillator plates are wrapped up in TYVEK L-1073D. The number of photoelectrons measured with Ru^{106} is 1 in the middle of scintillator and 4 cm apart the edge of plate. The difference in light yield response from opposite ends of the scintillators is about 50%, which approximately corresponds to the change of sampling.

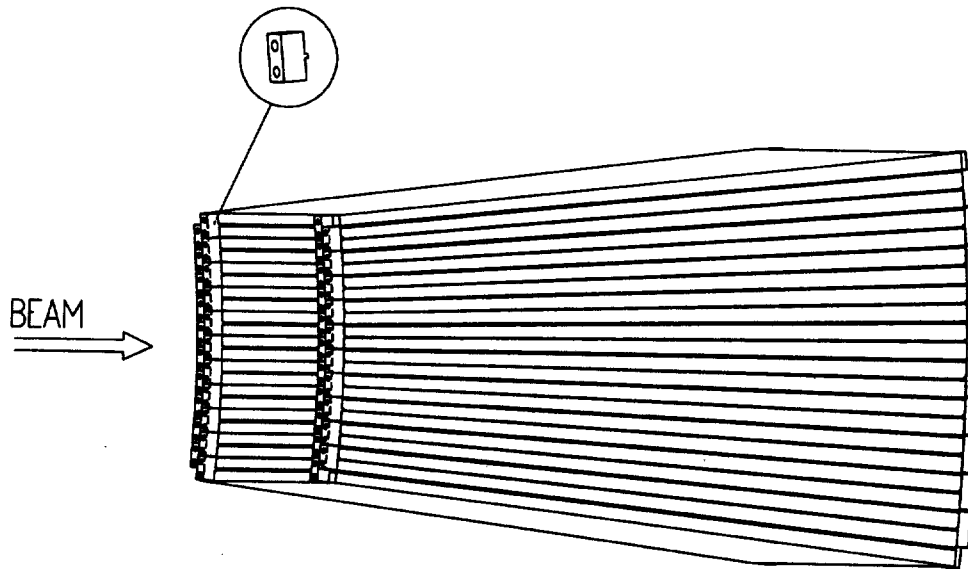

Fig. 1. The schematic view of the hadron calorimeter.

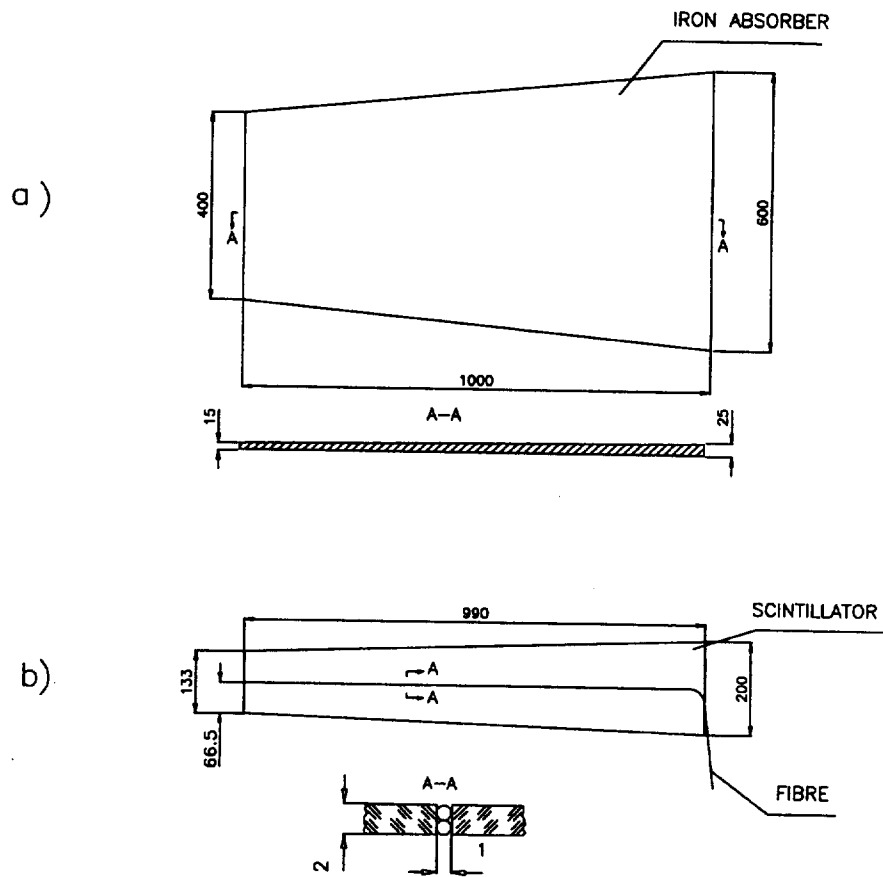

Fig. 2. Absorber plate - (a); scintillator plate with WLS fibres - (b).

As one can see from Fig.2 three scintillator plates are packed side by side on the absorber plate. Fibres from seven scintillators (Fig.3) are bundled together, glued in a cylindrical plastic tube, forming a tower and then coupled to a photomultiplier (FEU-84). The calorimeter has 9 towers (3×3). The light from a LED is fanned out to each phototube to control its gain during measurements.

2. Test-beam setup

The calorimeter was studied with the IHEP 22 beam line. The layout of the experimental setup is shown in Fig.4a. Three counters in coincidence (S_1-S_3) along the beam were used as the trigger. A particle trajectory was measured by the drift chambers with space resolution 200 μm . Energies of the negative particle beams were 10, 20, 30 and 40 GeV (95% π) and beam momentum spread was less than 1%. Part of the measurements was carried out with an electromagnetic calorimeter (ECAL) placed 50 cm upstream of the hadron one with dimensions 21cm×21cm×60cm (about $23X_0$, $1.2\lambda_{int}$). To calibrate the electromagnetic calorimeter an electron beam was used with 1% hadrons and muons contamination.

The intrinsic property of calorimeters with scintillators positioned parallel to particle trajectory (like "spaghetti" calorimeter) is the channeling effect – the signal dependence on the angle between the particle direction with reference to scintillator orientation. According to simulations carried out in [3] the effect is greatly reduced (as expected) if an electromagnetic calorimeter is installed upstream of the hadron one. To study this effect the angle between the particle trajectory and the hadron calorimeter axis was varied by rotating HCAL and bending the beam with the magnet so that the beam axis cross the centre of the hadron calorimeter.

3. Data analysis

The relative calibration coefficients of the electromagnetic and hadron calorimeters were obtained by minimization of the function:

$$F = \sum_{i=1}^N \left(\sum_{j=1}^9 \alpha_j \times A_{ij} + \alpha_{10} \times A_{i10} - E_b \right)^2, \quad (1)$$

where E_b is the beam particle energy, α_j is the calibration coefficient of tower j , A_{ij} is the amplitude of tower j for event i . Parameter α_{10} defines the ratio between the electromagnetic and hadron calorimeters.

For electromagnetic calorimeter towers the calibration coefficients were obtained using the electron beam. The coefficient

$$A_{i10} = \sum_{m=1}^9 \alpha_m^{EM} \times A_{im}^{EM} \quad (2)$$

is the energy measured by electromagnetic calorimeter (α_m^{EM} is calibration coefficients and A_{im}^{EM} is the amplitude of tower m for event i).

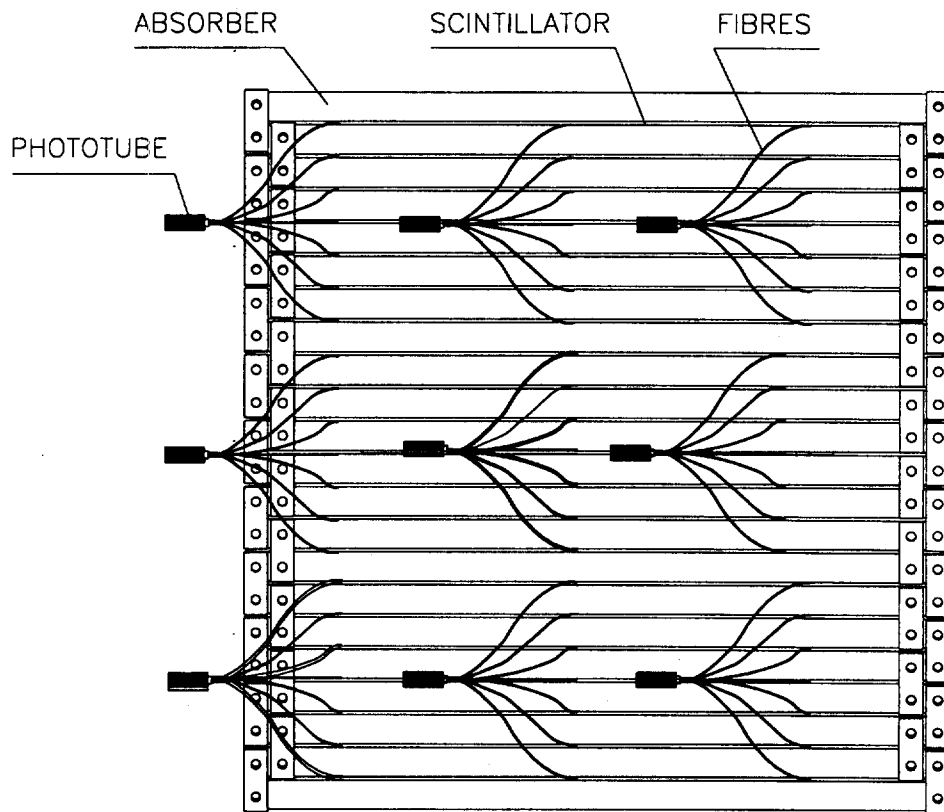

Fig. 3. The layout of fibres and photodetectors at the back side of the hadron calorimeter.

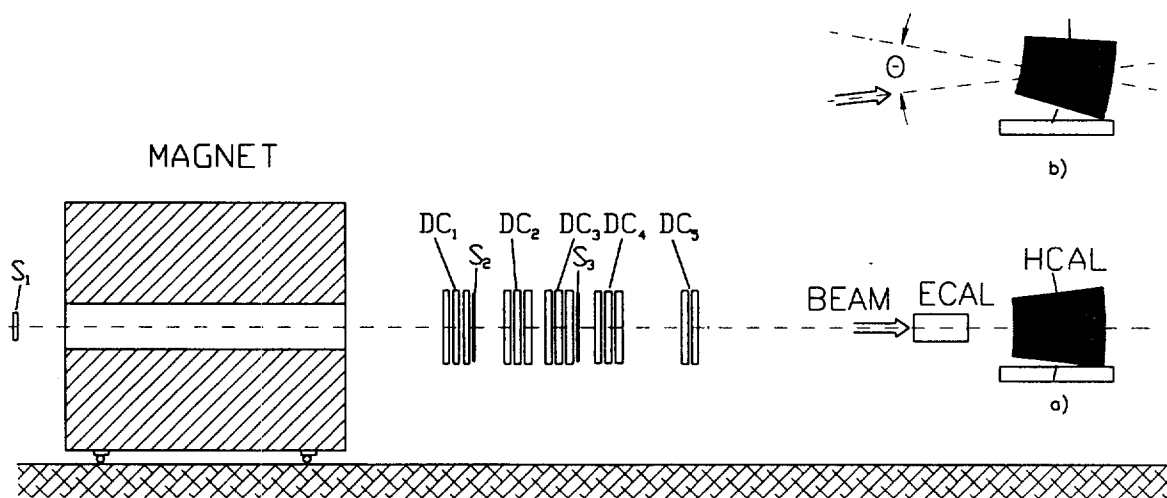

Fig. 4. The layout of the experimental setup. DC is a drift chamber, S is a scintillation counter, ECAL is the electromagnetic calorimeter, HCAL is the hadron calorimeter; (a) – HCAL is placed along the beam axis; (b) – HCAL is rotated.

For each event obtained for the fixed HCAL position the angle Θ_i between a particle trajectory and the calorimeter radius was defined as shown in Fig.4b. A segment of this radius contained between the front and the back face of HCAL is halved by particle trajectory. Then for N events the mean angle Θ was defined:

$$\Theta = \frac{1}{N} \times \sum_{i=1}^N \Theta_i. \quad (3)$$

Fig.5a shows the energy distribution for $\Theta=0$ mrad without ECAL (energy of particle beam was 10 GeV). This distribution has a long tail due to particle passage through a scintillator without interaction (channeling effect). There is also a coordinate dependence of calorimeter response. As is shown in Fig.6, the root mean square (RMS) of energy distribution as a function of particles' Y-coordinate at the front face of HCAL changes with a period of about 20 mm (structure period of HCAL at the front face is 18 mm, at the half of depth - 23 mm). This variation decreases with increase of angle Θ . The presence of ECAL in front of HCAL (Fig.5b) appreciably reduces the channeling effect and the coordinate dependence of calorimeter response.

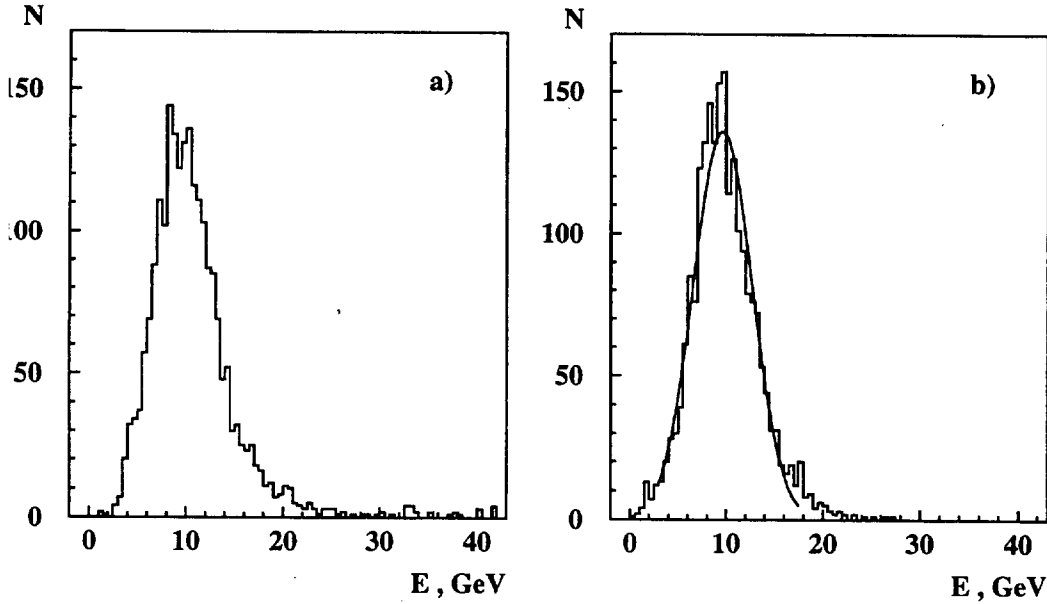

Fig. 5. Energy distribution: (a) - HCAL, $\Theta=0$ mrad; (b) - ECAL and HCAL, $\Theta=0$ mrad (solid line is the fit with the Gaussian function).

The RMS dependence of energy distribution on angle Θ shown in Fig.7 with (squares) and without (circles) ECAL is in a qualitative agreement with MC calculations. For this dependence the range of particles' Y-coordinate at the front face of HCAL was 18 mm wide and a scintillator plate was in the middle of it. The angular divergence in vertical plane was 6 mrad. No attempt was made to determine the energy resolution in the form $\frac{\sigma}{E} = \frac{A}{\sqrt{E(\text{GeV})}} \oplus B$ because with ECAL in front of HCAL the leakage was already noticeable at 20 GeV. For 10 GeV pions and $\Theta=85$ mrad the energy resolution is $\frac{\sigma}{E} = (24,7 \pm 0.3)\%$.

The reconstructed energy distribution for muons is presented in Figs.8a, 8b without ECAL for $\Theta=0$ mrad and $\Theta=85$ mrad, correspondingly and in Fig.8c with ECAL in front of HCAL for $\Theta=0$ mrad.

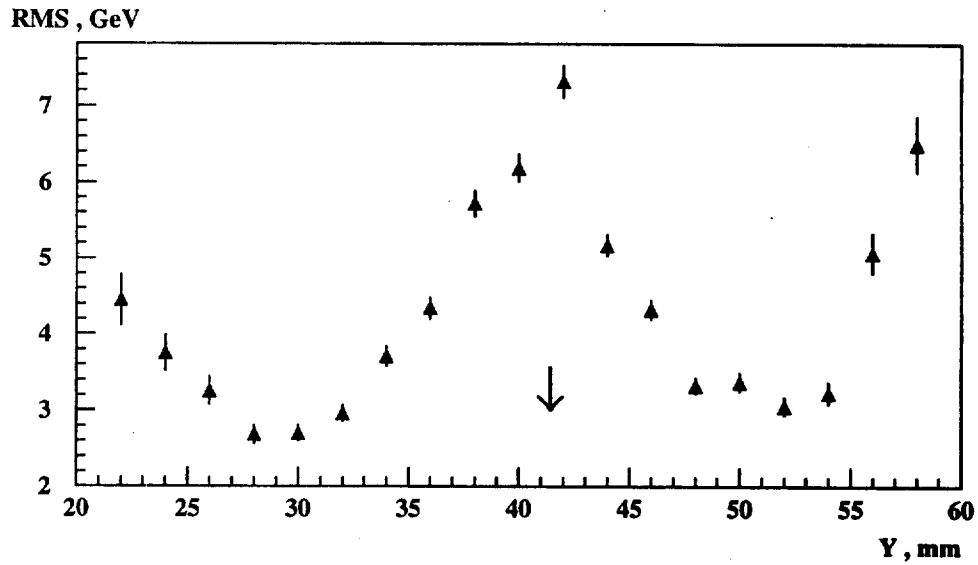

Fig. 6. The root mean square of the energy distribution as a function of particles' Y-coordinate at the front face of HCAL (the arrow approximately shows the position of a scintillator plate).

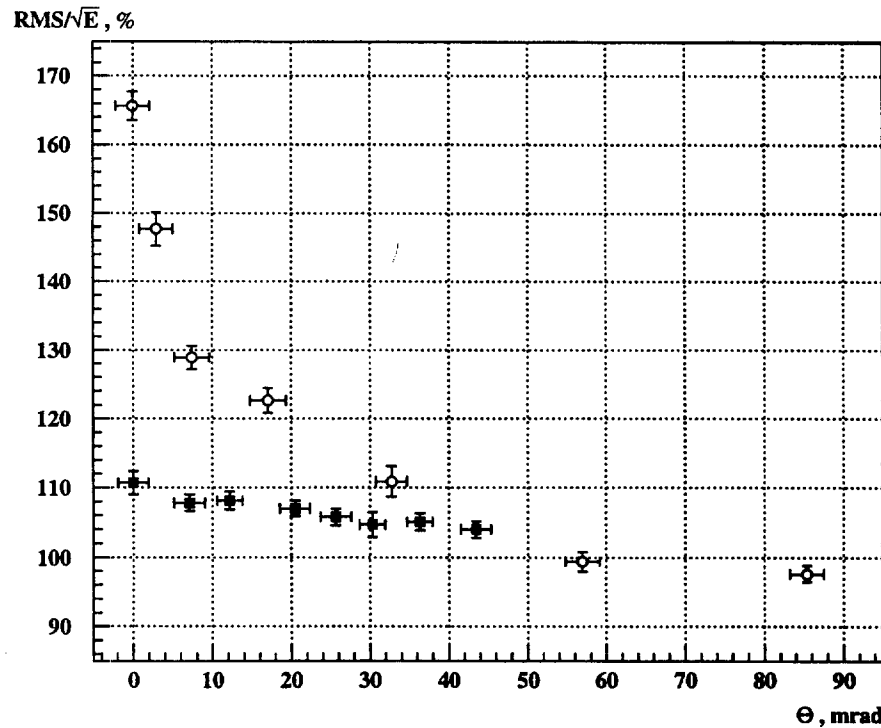

Fig. 7. The $\frac{RMS}{\sqrt{E(GeV)}}$ dependence on angle Θ with (squares) and without (circles) ECAL in front of HCAL.

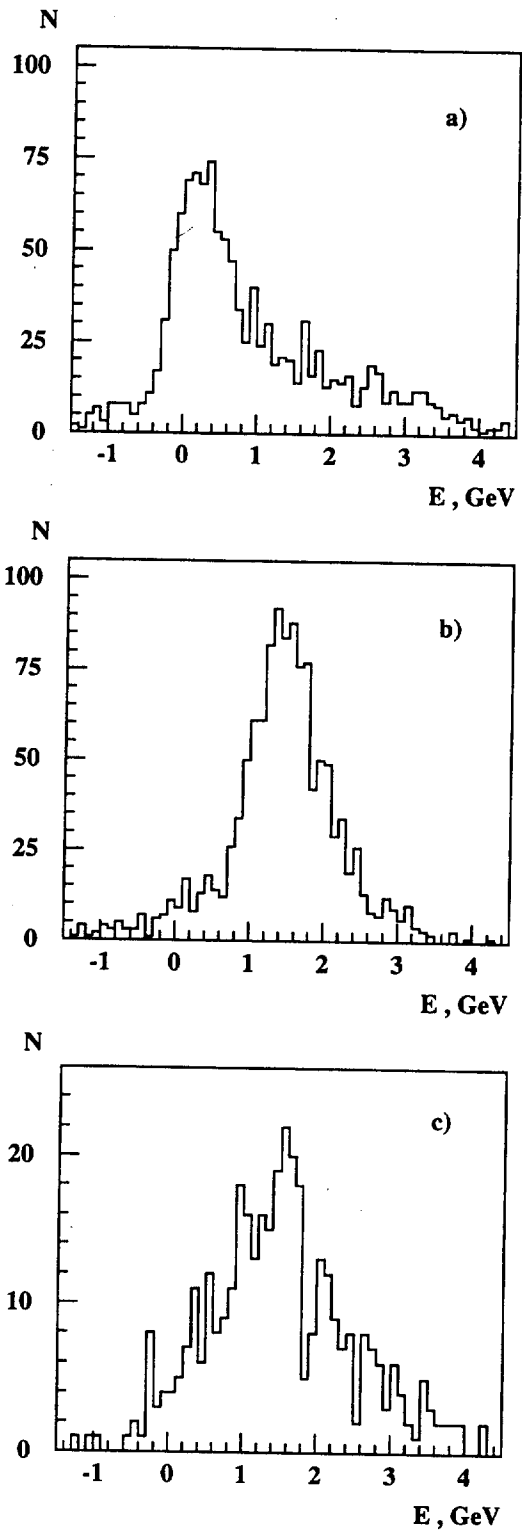

Fig. 8. Reconstructed energy distribution for muons: (a) - HCAL, $\Theta=0$ mrad; (b) - HCAL, $\Theta=85$ mrad; (c) - ECAL and HCAL, $\Theta=0$ mrad.

Summary

It has been shown that it is easy to realize fully projective geometry for the proposed calorimeter design.

The energy resolution of the calorimeter with varying sampling qualitatively agrees with MC calculations.

With an electromagnetic calorimeter in front of the hadron one the channeling effect is negligible.

References

- [1] Kryshkin V., Lapshin V., Mysnik A. et al. Instr. and Exp. Techn. 3(1993)43.
- [2] Inyakin A., Kryshkin V., Lapshin V. et al. Preprint IHEP 93-157, Protvino, 1993.
Dolgoplov A., Inyakin A., Kryshkin V. et al. Nucl. Instr. and Meth. A363(1995)557.
- [3] Kostritskii A., Baliev L., Buzulutskov A. et al. Instr. and Exp. Techn. 5(1994)49.

Received December 11, 1996

В.В.Абрамов, П.И.Гончаров, А.М.Горин и др.

Адронный калориметр со сцинтиллятором, расположенным параллельно пучку.

Оригинал-макет подготовлен с помощью системы \LaTeX .

Редактор Е.Н.Горина.

Технический редактор Н.В.Орлова.

Подписано к печати 18.12.96. Формат 60 × 84/8. Офсетная печать.

Печ.л. 1. Уч.-изд.л. 0.76. Тираж 240. Заказ 914. Индекс 3649.

ЛР №020498 06.04.92.

ГНЦ РФ Институт физики высоких энергий

142284, Протвино Московской обл.

Индекс 3649

ПРЕПРИНТ 96-106, ИФВЭ, 1996
