

CMS Conference Report

December 11, 1996

Track Finding Processor in the DTBX Based CMS Barrel Muon Trigger

Alexander Kluge, Torsten Wildschek
CERN, Geneva, Switzerland

CMS Collaboration

Abstract

We present the design and simulation of the track finding processor in the DTBX (Drift Tube with Bunch Crossing Identification) based CMS barrel muon trigger system. The processor searches for muon tracks originating from the interaction region by joining the track segments provided by the mean timer processors of the drift chambers to track strings. It assigns transverse momenta to the reconstructed tracks using the tracks' bending angle. High speed is achieved by performing the track reconstruction fully in parallel. In this contribution the algorithms, implementation and simulation results are presented.

Presented at *First Workshop on Electronics for LHC Experiments*, Lisboa, September 11-15, 1995

Track Finding Processor in the DTBX Based CMS Barrel Muon Trigger

Alexander Kluge, Torsten Wildschek
CERN, Geneva, Switzerland

We present the design and simulation of the track finding processor in the DTBX (Drift Tube with Bunch Crossing Identification) based CMS barrel muon trigger system. The processor searches for muon tracks originating from the interaction region by joining the track segments provided by the mean timer processors of the drift chambers to track strings. It assigns transverse momenta to the reconstructed tracks using the tracks' bending angle. High speed is achieved by performing the track reconstruction fully in parallel. In this contribution the algorithms, implementation and simulation results are presented.

INTRODUCTION

The barrel part of the CMS muon system consists of 4 muon stations, divided into 5 wheels along the z-axis and into 12 sectors along the azimuthal angle, giving a total of 60 modules per station (see fig. 9 and 1). Each module comprises dedicated trigger detectors (RPCs) and drift chambers [1]. The latter are used for off-line reconstruction and for triggering. Each drift chamber consists of two superlayers of drift tubes for measuring in the bending projection ($R\Phi$) and one superlayer for measuring in the non-bending projection. Each superlayer in turn is formed of four staggered layers of drift tubes. The good spatial resolution of the drift tubes is expected to facilitate momentum measurement with good resolution and hence the design of a trigger with a sharp efficiency curve.

INPUT TO THE TRACK FINDING PROCESSOR

The chamber trigger logic, which enables the identification of the bunch crossing, is based on a mean timer-technique [2]. The output primitive of the chamber logic is the track segment (TS), a triple of position, crossing angle and quality data. Those data are transferred to the trigger processor at a fixed delay after the bunch crossing from which the muons originate. Per chamber up to two track segments (TS) in each projection can be output. The position is measured with a discretization step of 1.25 mm (or a multiple), the crossing angle with 10 mrad at normal incidence; measurement range for the crossing angle is -45° to $+45^\circ$. However, this angular resolution can be achieved only if both superlayers of that chamber contributed to the track segment. The actual resolution will thus be considerably worse than the nominal figure suggests. It should be mentioned that what is needed for our computations is not the position and the crossing

angle with respect to the chamber, but the azimuthal angle of the hit position and the angle of the track with respect to the radius vector. Whether the required conversion will be carried out in the chamber trigger logic or in the track finding processor described here is still subject to discussion.

PURPOSE OF THE TRACK FINDING PROCESSOR

The task of the trigger processor is to assemble track segments to tracks (track finding). After checking whether a found track points to the interaction region, transverse momentum, direction values (η, Φ) and a track quality code are assigned.

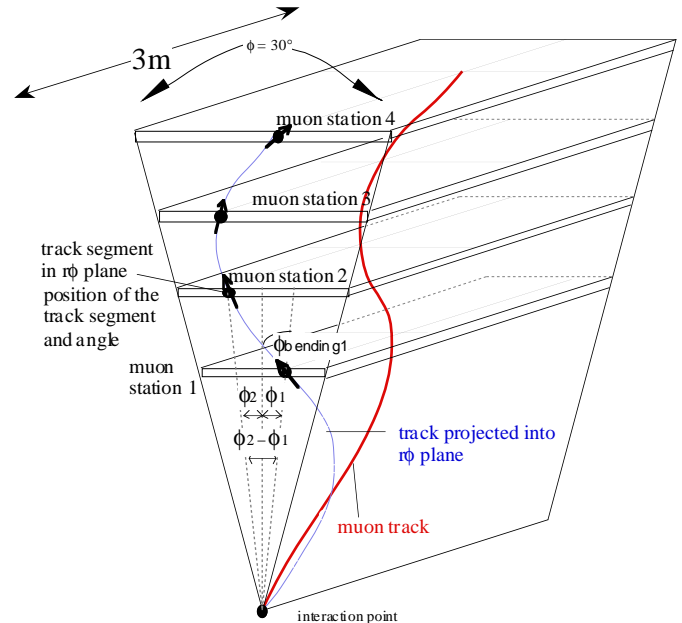

Fig 1: A sector of the CMS muon chamber system.

DESIGN CONSIDERATIONS

The first decision to be taken was how many track segments should be required in order to form a track. The first approach was to demand track segments in at least three out of the four muon stations or in the innermost two stations to accommodate tracks with low transverse momentum. However, it turned out that this would result in a serious drop in acceptance, so the requirement was relaxed to require track segments in at least two muon stations only (see fig. 2).

TRACK FINDING ALGORITHM

Two approaches for track finding in the bending plane were considered. The template matching (or pattern comparison) technique consists in comparing the candidate against a predefined set of "valid" patterns obtained by simulation and updated using the measurements. However, one of the design goals of this muon trigger is to make use of the good position resolution provided by the mean timers. Good resolution implies a large number of patterns to be stored, which results in a prohibitively high hardware expense. For that reason the pattern comparison method was rejected.

The second method considered could be called pairwise matching method. Track segments are joined to track strings by pairwise matching. If two track segments from different stations are found to be compatible with originating from a single track, they form a track segment pair, the most primitive track string; if one of those two track segments is compatible with a third track segment from a station other than the two already belonging to that track string, a track segment triple is formed. A matching

The matching of two track segments will be carried out by extrapolating (recall that the angle of the track is measured along with the position) one of the track segments to the station of the second track segment and checking that the difference between the extrapolated position value and the measured value of the second track segment is below a specific threshold. (see fig. 3)

Simulations were carried out to prove that all required extrapolations are feasible. Due to the fact that the tracks' bending angle (angle between the track and the radius vector in the bending plane, fig. 1) has a zero crossing which occurs between station 2 and station 4 no unambiguous extrapolation from station 3 to any other station is possible. However, all other extrapolations are unambiguous (fig. 4).

A second requirement for feasibility of the extrapolation

Acceptance Study

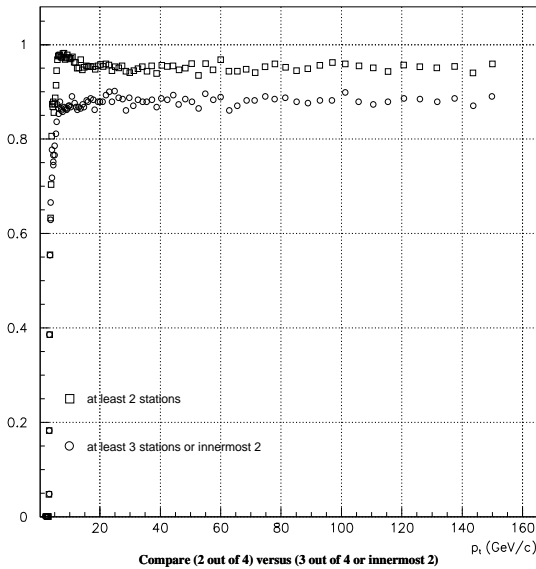

Fig. 2: Acceptance study for two track finding conditions.

fourth track segment from the remaining station would yield a track segment quadruple. Although the process has been described in a serial way, all the forming of track segment pairs can be carried out in parallel.

Fig. 3 illustrates the principle of the pairwise matching method. After track segment pairs are found by pairwise matching these pairs may be joined to track segments triples or quadruples (track finding). If a valid track was formed by the track finder a p_t value is assigned (p_t -assignment).

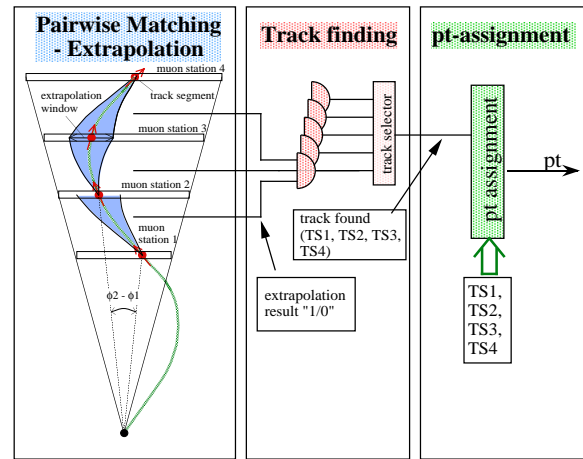

Fig. 3: Principle of the track finding processor.

Extrapolations

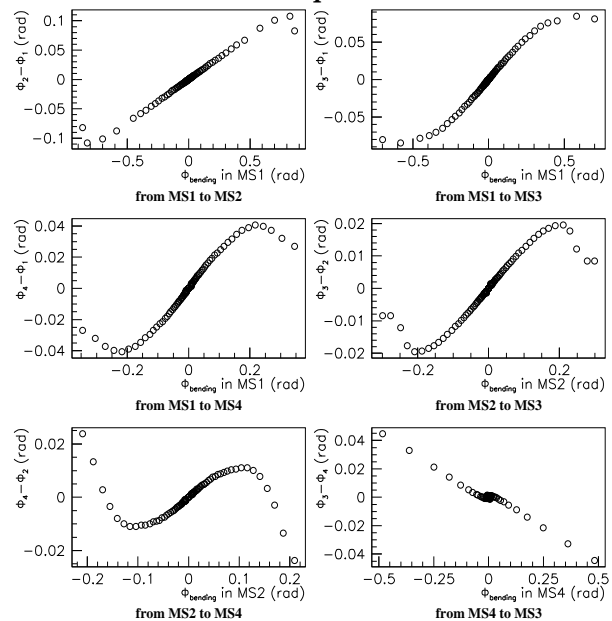

Fig. 4: Relation between bending angle (ϕ_{bending}) in a station and the difference of the azimuthal hit coordinates of the same and a different station.

Extrapolation deviations

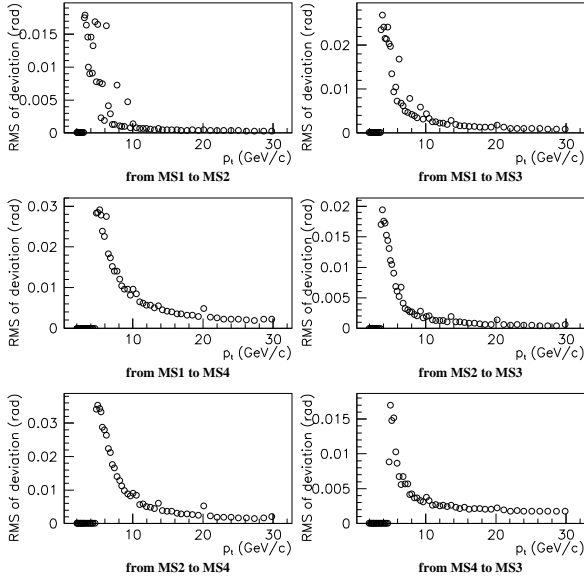

Fig. 5: Spread of extrapolation deviations versus transverse momentum p_t .

method is that the spread of the extrapolation deviation (defined as the difference of the extrapolated and the measured value) is small compared to the chamber dimensions (one chamber spans about 0.5 rad in Φ). Fig. 5 shows that the deviation of the extrapolation is found to be below the required limit. The pairwise matching method was thus adopted.

P_T ASSIGNMENT

For assigning a transverse momentum one can exploit either the bending angle or the sagitta of the track in the muon system. The drawback of the sagitta method is higher

Differences of azimuthal hit coordinates

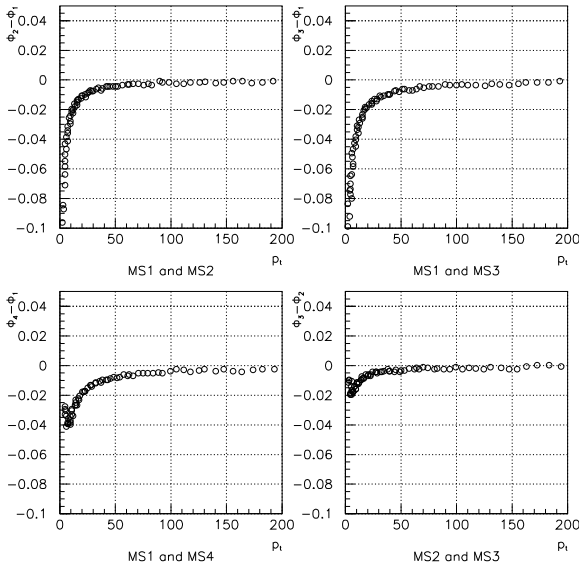

Fig. 6: Differences of azimuthal hit coordinates versus p_t .

complexity of the hardware implementation: To determine a sagitta either two measured angles or three measured positions can be used. The poor resolution of the angular measurement would force us to use three positions which implies more data transfer and more expense for look up-tables.

Determining the bending angle can be done via a single angular measurement (with poor momentum resolution) or using a difference of two azimuthal position measurements. The bending angle measurement was chosen to determine p_t . Fig. 6 shows the relation between p_t and the differences of azimuthal hit coordinates from two track segments. Fig. 7 displays the relation between p_t and the track bending angle obtained from only one track segment.

Bending angle versus p_t for μ^+

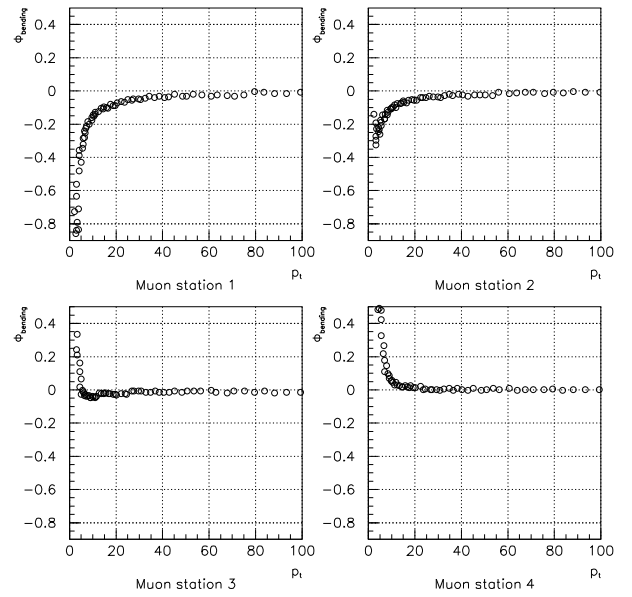

Fig. 7: Bending angle determined by single angle measurement versus p_t .

PERFORMANCE

Efficiency curves for several values of p_t -threshold are shown in figure 8.

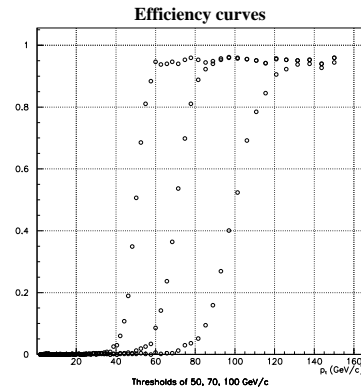

Fig. 8: Efficiency curves for the whole DTBX drift tube trigger system for the thresholds 50, 70 and 100 GeV.

HARDWARE REQUIREMENTS OF THE TRACK FINDING PROCESSOR

The majority of the previously implemented hardware triggers for muon identification in large scale high energy physics experiments are based on pattern comparison methods. Most of the systems only count the number of muons crossing the muon system and do not measure any particle properties like p_t or track location. All previously implemented muon triggers have in common that the number of channels, i.e. the size of the detector, is 10 to 100 times smaller than the size of CMS and the required maximum calculation time is at least 10 times higher.

The design of the data acquisition system of CMS [1] requires a maximum latency for the track finder system of 400 ns. The p_t information of muons which crossed the muon system must be given to the global trigger each 25 ns. Processing must therefore be deadtimeless. This implies a low possible number of calculation steps and a quite well adapted projection of the chamber geometry to the hardware system. Due to the high magnetic field and the non-projective chamber system the particles cross segment boundaries often. This poses a major challenge to the system design of the track finder since all data exchange between processing units contribute to the latency.

For reasons of calculation speed the trigger processor has to be designed in a hardwired way. Each trigger decision must be made after a fixed time, independent of the data. This implies design restrictions that have to be made in order to render hardware complexity and calculation time reasonable. The impact of these restrictions were examined using a VHDL-model of the system. The VHDL-model of the design was used to optimize the system parameters with respect to the hardware extent and system performance.

A very important property of the trigger is its programmability. Of course, hardwired design and a large freedom in programmability are contradictory. There are, however, some aspects in the overall design of the system which require easy and automated reprogrammability. An example is the possibility of chamber misalignment. Extrapolation values would have to be adapted to the new environmental settings in a convenient fast way.

Special focus was given to the modularity of the design. It ensures independence of the design from global parameters like the maximum number of track segments given by the mean timer electronics.

OVERALL DESIGN OF THE TRACK FINDING PROCESSOR

This system is divided into five ring trigger sorters ($\Delta\eta \times \Delta\phi = 0.35 \times 2\pi$, see fig. 9). Each ring trigger sorter is subdivided into twelve sector processors (track finders) with a segmentation $\Delta\eta \times \Delta\phi = 0.35 \times 0.52$. A sector

processor matches the track segments identified by the meantimer logic and tries to form complete tracks. If the sector processor succeeds, it assigns a p_t value to each track, tests if the track extrapolates to the interaction point and then forwards up to two tracks to the ring trigger sorter. Of the 12×2 possible tracks identified by the sector processors only the four tracks with the highest p_t are retained by the ring trigger sorter. All the information on these tracks - p_t , charge, η , ϕ , quality - is then forwarded to the global muon trigger.

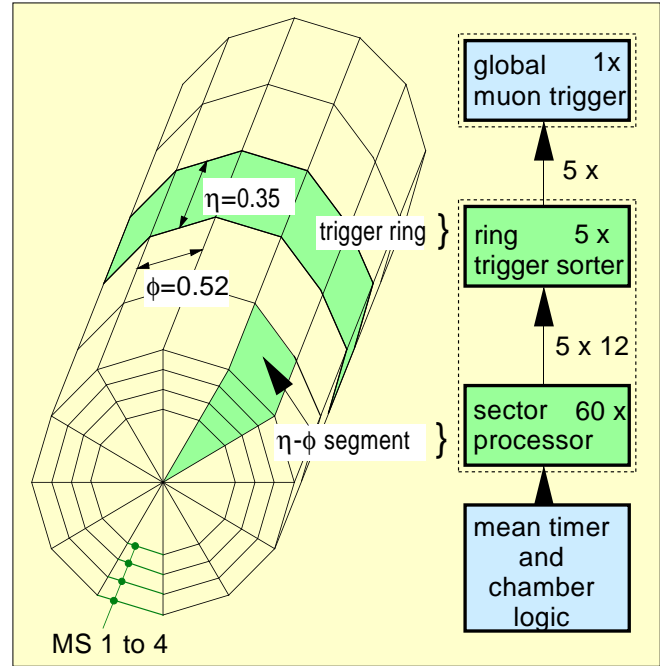

Fig. 9: Track Finding (or Sector-) Processor Segmentation and Logic Block Diagram.

The Sector Processor (SP)

In fig. 10 the block diagram of the track finder system is displayed. The sector processor (SP) is divided in three parts - the extrapolator (EU), the track finder (TF) and the p_t , η - and ϕ -assignment units (PAU, ηAU , ϕAU), see also fig. 3. The extrapolation units attempt to match track segment pairs of distinct stations using the extrapolation criteria described above. When track segment pairs meet these criteria this information is forwarded to the track finder unit (TF). It evaluates all extrapolation results in order to find up to two complete tracks. The track finder conditions mentioned earlier are applied. The output of the track finder unit are the addresses of the track segments for each found track. The track router (TR) - a multiplexer array - forwards the corresponding track segment data to the p_t , η - and ϕ -assignment units (PAU, ηAU , ϕAU).

On-line test facility

Since the performance of the trigger will directly influence the data quality and thus the performance of the whole experiment, special attention has to be given to the capability of trigger monitoring and hardware error detection. An on-line test feature for the system was designed. It is able to test the functionality at all times - even during data taking. It is particularly important to be able to monitor the system remotely and automatically for two reasons: Firstly it will not be possible to access the system during data taking and secondly the complexity of the system makes any 'conventional' test feature impracticable. Each sector processor will contain several monitoring units capable of being triggered and read out by a central monitoring unit. A monitoring processor will be responsible for recalculating of the trigger decisions made by the trigger processor. In case of errors this is an efficient way to detect damaged parts in the system.

REFERENCES

- [1] CMS, The Compact Muon Solenoid, Technical Proposal, CERN/LHCC 94-38, LHCC/P1, 15 December 1994
- [2] M. De Giorgi et al., Design and Simulations of the Trigger Electronics for the CMS Muon Barrel Chambers, CMS TN/95-01, CERN, 12 January 1995

and
the talk by R. Martinelli at this workshop

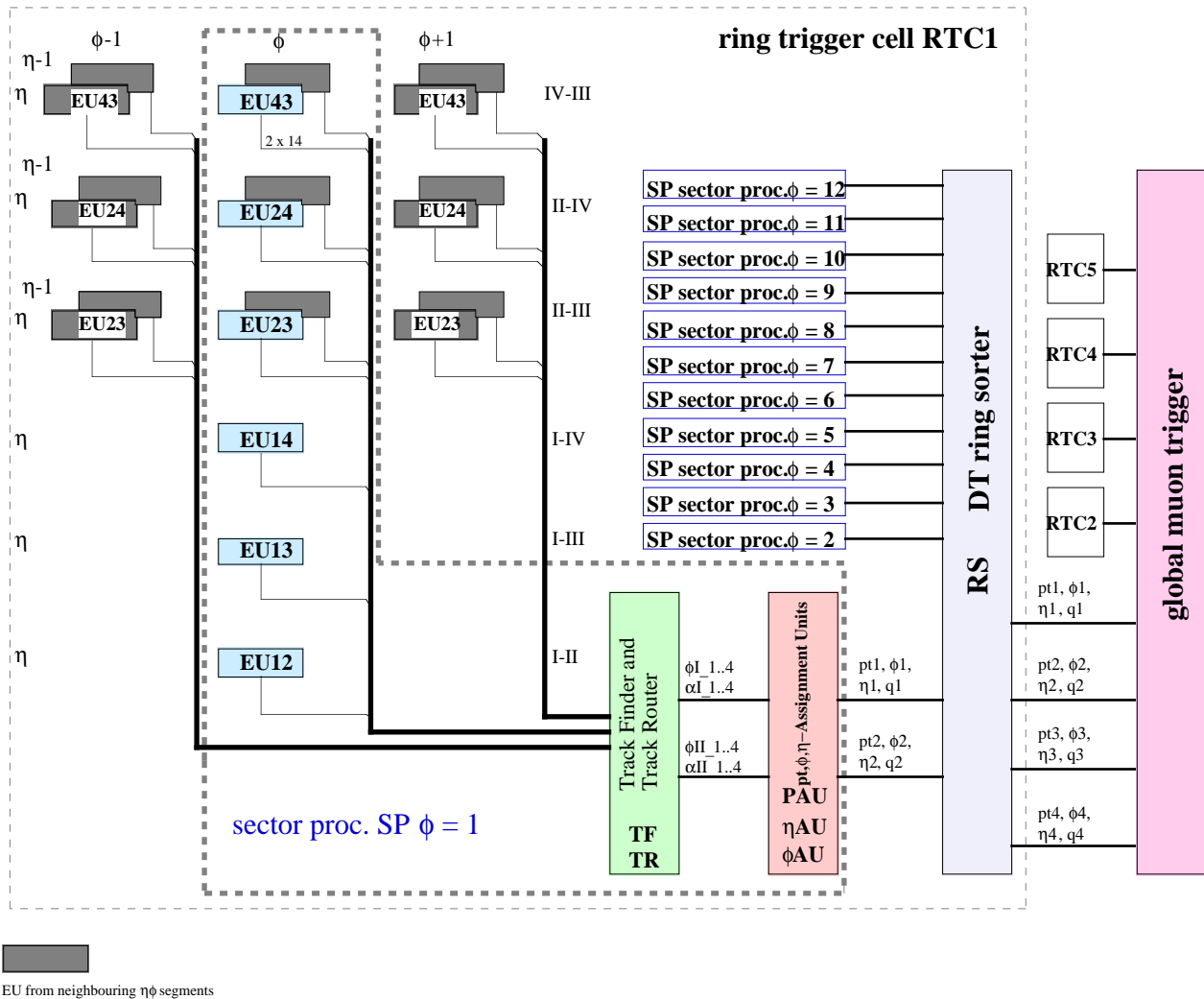

Fig. 10: Block Diagram of the Track Finding Processor System.