

Status of the ATLAS Tile Calorimeter

Henric Wilkens on behalf of the ATLAS collaboration.

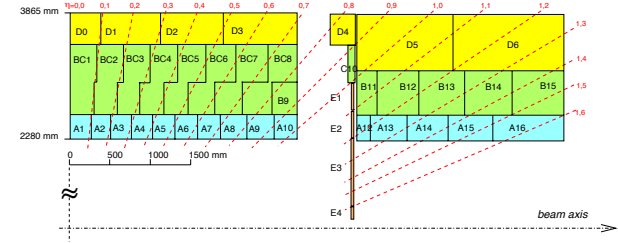

Tilecal: the Barrel Hadronic Calorimeter

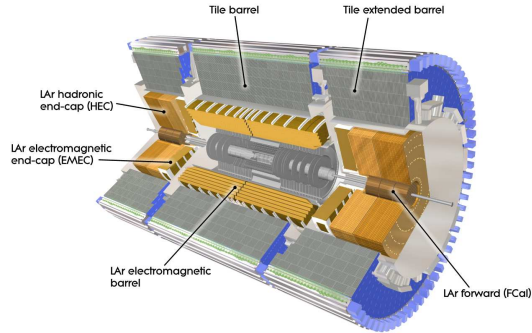

Tilecal pseudo projective cell layout

One long barrel ($|\eta| < 1.0$) and 2 extended barrels $0.8 < |\eta| < 1.7$, about 7λ in depth, each composed of 64 modules in Φ .

Steel plates and plastic scintillators (the tiles) coupled to wavelength shifting fibres.

5198 pseudo-projective cells, 3 longitudinal layers in depth.

each cell readout by 2 PMTs (~ 10000 PMTs* in total)

Dynamic range 10 MeV to 2 TeV per cell.

$$\text{design jets resolution: } \frac{\sigma_E}{E} = \frac{50\%}{\sqrt{E[\text{GeV}]}} \oplus 3\%$$

(*) Hamamatsu R7877 8 stage

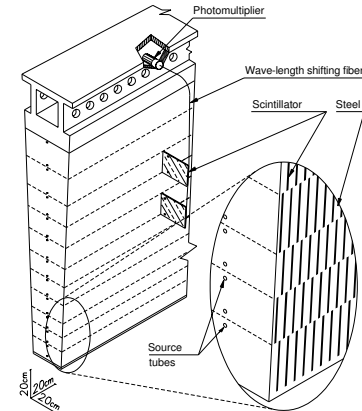

The Tilecal community



25 universities and institutions,
over 100 engineers, scientists and students

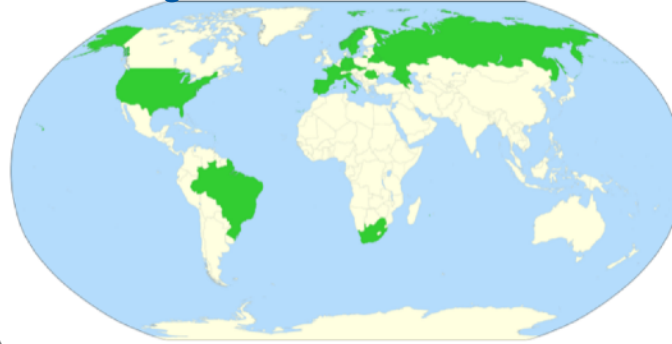

Energy Calibration

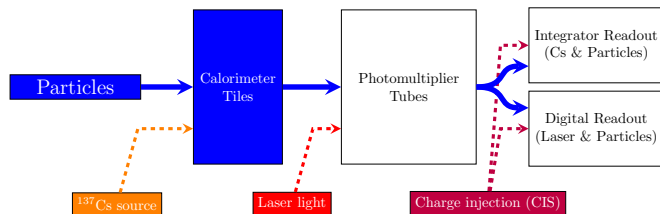

$$E_{\text{pmt}} = \text{Amplitude} \times C_{\text{ADC} \rightarrow \text{pC}} \times \xi_{\text{laser}} \times \xi_{\text{Cs}} \times C_{\text{pC} \rightarrow \text{MeV}}$$

Factors in the calibration:

- $C_{\text{ADC} \rightarrow \text{pC}}$: The Charge Injection System monitors electronics stability. *Runs 2 times/week, calibrated monthly.*
- ξ_{laser} : A laser system monitors PMT gain and timing of individual channels. *Daily runs, calibrated weekly + Empty bunch crossings (12Hz)*
- ξ_{Cs} : Maintain same cell response to known source. *Calibrated monthly.*
- $C_{\text{pC} \rightarrow \text{MeV}}$: 11 % of the Tilecal modules where calibrated at the SPS with e^+ , μ^+ , hadrons, to determine the Electromagnetic Scale.

Calibration strategy: Use the laser to tune channels that drift more than a few % in between monthly Cs runs to maintain the determined E-scale.

Cesium calibration

The ^{137}Cs system is TileCal primary calibration system.

- A hydraulic system in each cylinder allows to circulate a tiny capsule with ^{137}Cs through each tile periodically (\sim monthly).
- The hydraulic circuit is ~ 4.3 km in the central cylinder, ~ 2.4 km in external cylinders.
- PMT signals are digitised after integration.

In addition the integrator readout is in Physics run to collect Min-Bias(MB) induced currents for Luminosity measurement and cross-calibration.

Ref: G. Blanchot *et al* 2020 *JINST* 15 P03017

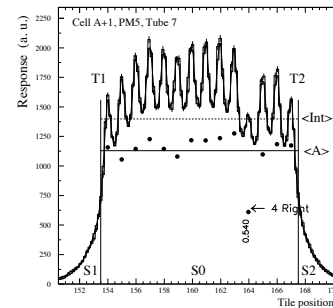
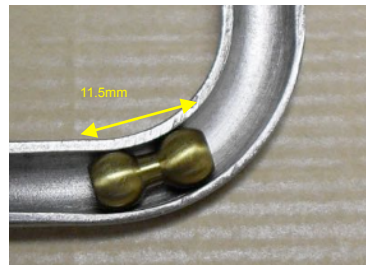

example of a PMT readout at 90Hz

^{137}Cs capsule in section of transport pipe

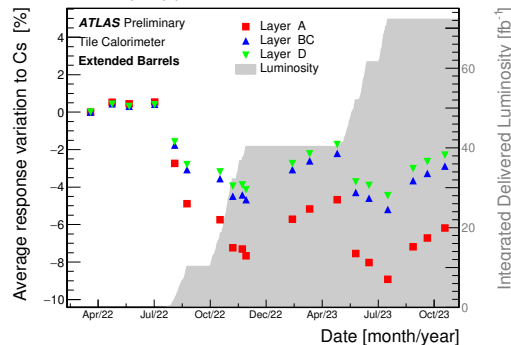

Average response variation of TileCal cells in Extended Barrels to cesium source as a function of time in 3 different longitudinal layers during Run3

Laser and Charge Injection calibration systems

A laser source* provides 532 nm, 10 ns pulse distributed to each PMT:

- Signals collected in dedicated runs and in the LHC empty bunches during ATLAS physics runs.
- Provides PMT gain and timing corrections (f.i. from SEUs).
- Precision of the system at the level of 0.5%

Ref: JINST 18 (2023) 06, P06023

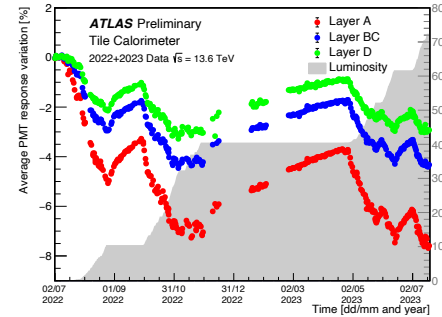

Relative PMT gain evolution in 2023

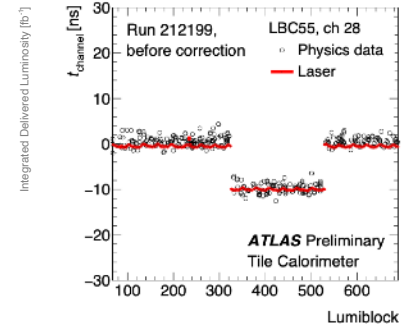

Detection of a timing change in a p-p physics run

The Charge Injection System (CIS) injects well defined charges in the high and low gain ADC reading each PMT:

- Determines the amplitude [ADC count] to charge [pC] conversion factors
- Used also to calibrate the analogue L1 trigger system.
- Precision is 0.7%, very good stability over time.

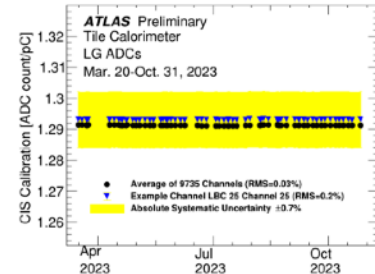
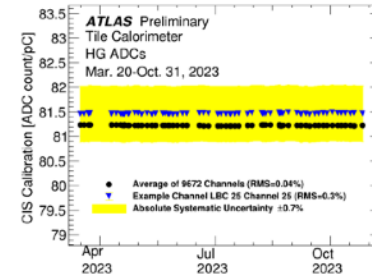

(*)J40-BLS6 from Spectra-physics

High and Low gain ADC coefficients stability in 2023



Ageing Run2

Scintillator¹ and Wavelength Shifting fibre² ageing:

- Comparing the Cs [or MB] results with Laser results we can assess the light yield degradation:

$$I/I_0 = \frac{\Delta R_{Cs/MB}}{\Delta R_{Las}} = p_0 e^{-dose/p_1}$$

- Different cells accumulated dose depending on position:

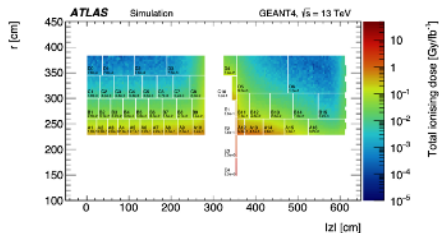

- A dedicated paper is in preparation, in addition to

Ref: "Operation and Performance of the ATLAS tile calorimeter in LHC Run-2", arXiv:2401.16034, submitted to EPJ-C

1) Polystyrene (PSM115 & BASF165H), 1.5% p-Terphenyl, 0.04% POPOP

2) Y11(200)MSJ from Kuraray

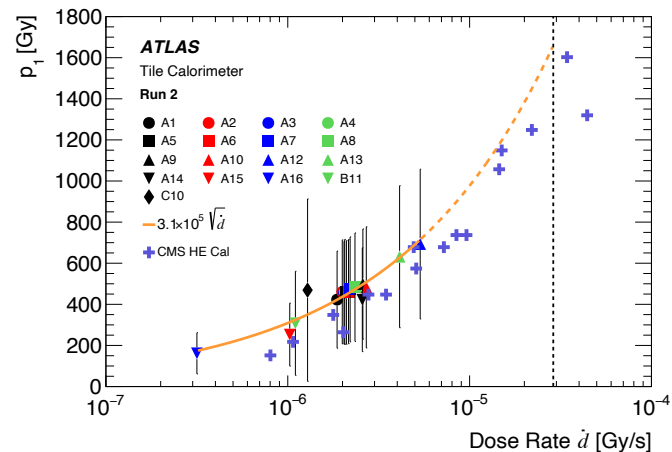
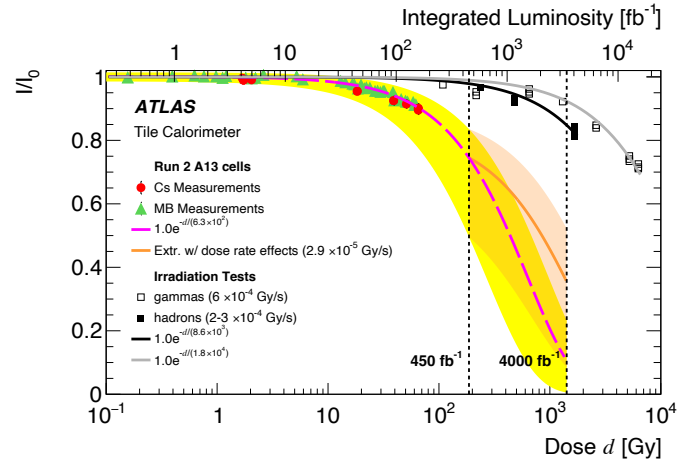

Isolated Muons from W decays

EM scale and uniformity was validated with Isolated muons:

- Momentum range 20 to 80 GeV/c, where ionisation dominates ΔE scales with path length Δx

- Evaluate truncated mean $\Delta E/\Delta x$

- Use $R = \frac{(\Delta E/\Delta x)_{\text{data}}}{(\Delta E/\Delta x)_{\text{MC}}}$ to avoid residual non-

linearity of truncated mean in each cell.

- Extract layer mean R and cell type mean R through Likelihood fit:

Results for Run-2:

Ref: "Operation and Performance of the ATLAS tile calorimeter in LHC Run-2", arXiv:2401.16034, submitted to EPJ-C

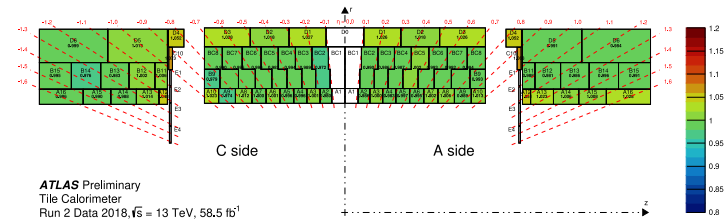
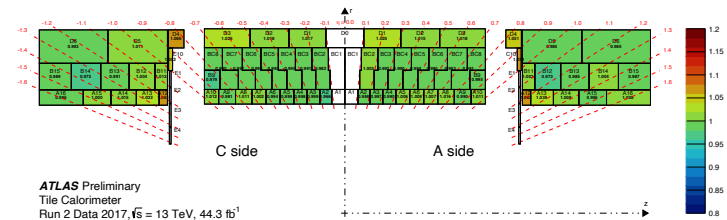
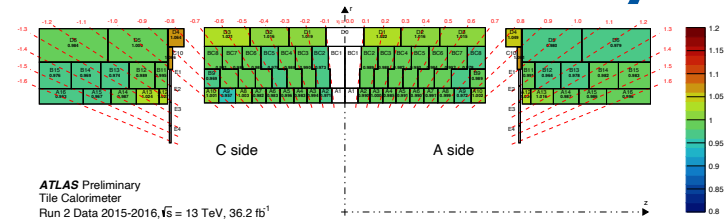

Single isolated hadrons

The ratio of the energy deposited in the TileCal (E) divided by the momentum measured in the Inner Detector (p)

- calorimeter clusters ($\Delta R = 0.2$) associated to tracks
- muons and neutral particles removed from analysis

Compare E/p for data and MC:

- non-compensated calorimeter $\rightarrow E/p < 1$
- good agreement data/MC for low pile-up ($\langle \mu \rangle \approx 2$)
- systematic uncertainties considered:
 - residual contribution from neutral particles ($\sim 1\%$)
 - upstream dead material for $|\eta| > 0.7$ (few %)

Ref: "Operation and Performance of the ATLAS tile calorimeter in LHC Run-2", arXiv:2401.16034, submitted to EPJ-C

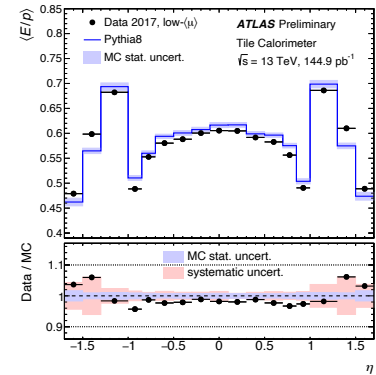
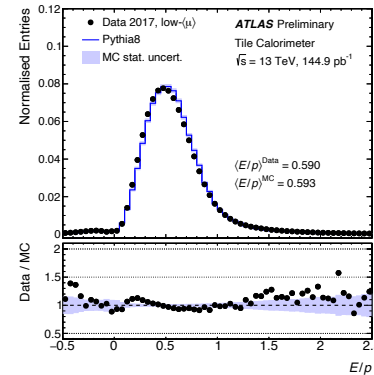

The Tile Calorimeter HL-LHC upgrade

Selected items

Tilecal's Upgrade

Motivated by:

- Lifetime of Tilecal extended decades (HL-LHC 2029-2040).
- Higher radiation environment (Luminosity x5-7 compared to nominal LHC)
- New triggering requirements

Upgrade of Tile calorimeter

- Active dividers on all PMT, replacement of 10% of the PMTs.
- Complete replacement of on and off-detector electronics.
- 40 MHz readout to off-detector electronics. 40 Tb/s over 6000 optical fibres.
- Improve reliability (full readout redundancy, new HV and LV systems) and maintainability (new mechanics).

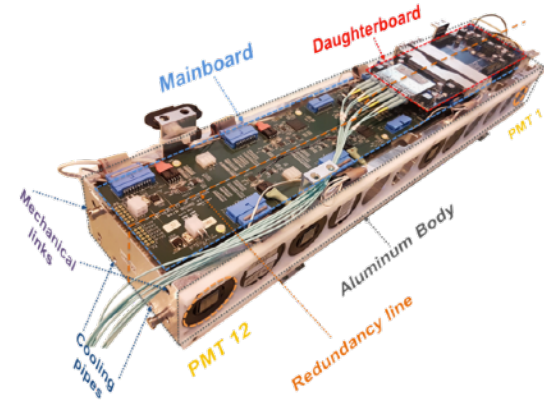
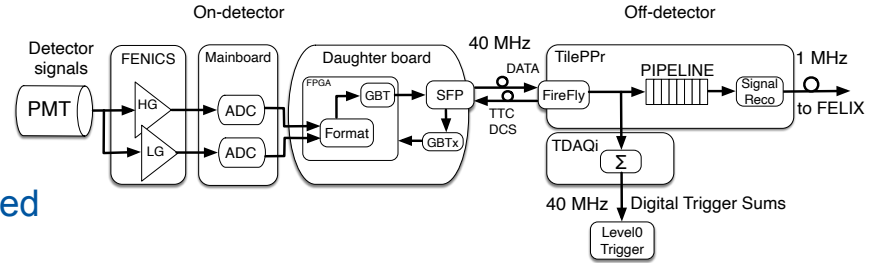

The mini-drawer, the basic on-detector unit

The mechanics

Currently Tile electronics housed in 1.75 m long drawers. They are quite cumbersome to extract to access electronics.

The upgrade mechanics consists of shorter modules (694 mm, 22 kg when equipped), which can be easily handled on the scaffolding. There are specific modules to accommodate the different geometries in the extended barrels, in totals 7 different types.

Associated are dedicated tooling for the mechanics insertion, extraction and new services (LV&HV cables, Fibre optics, cooling distribution)

All components produced and delivered.



Work on Tile electronics on-detector



new tooling

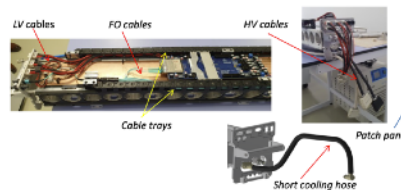

new services for the electronics

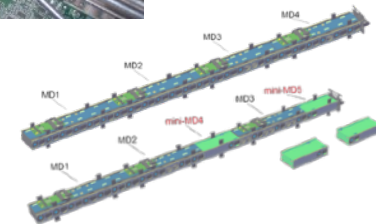

new mechanics for Barrel and Extended-Barrel

Short Cooling hose

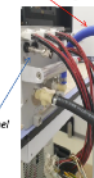

On-detector electronics: The PMT block

We will reuse 90% of the PMTs (Hamamatsu R7787), and use 10% of new R11187, more stable, in the most exposed region of the detector.

Dedicated test-benches operational at Bratislava, Pisa and CERN to test PMTs.

Passive HV dividers will be replaced with active dividers (all produced) to provide better response stability at high anode currents.

New front end, the FENICS (in production):

- Pulse shaping at 2 gain (x0.4, x16), 0.2 pC to 1000 pC dynamic range.
- Current integration with 5 gains (0.02-13000 nA) for ^{137}Cs calibration and luminosity studies.
- Built-in Charge Injection system for ADC calibration.

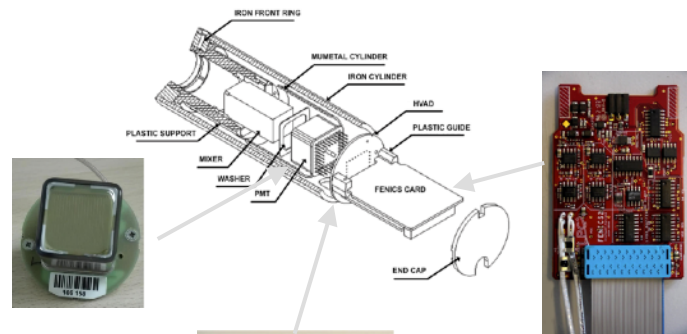

Hamamatsu PMT

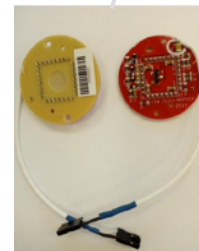

New active HV dividers

New FENICS front end

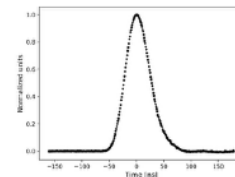

Pulse shape in HG from 2022 test-beam data

On-detector electronics: The MainBoard

Receives and digitises the analog signals from the FENICS:

- 12 bit dual ADCs at 40 Msample/s for 2 gain signals.
- 16 bit ADC at 50 ksamples/s for integrated signal readout.

Routes the high speed data to the DaughterBoard.

Distributes power (10 V), independently on each side (improves reliability)

Controls the FENICS.

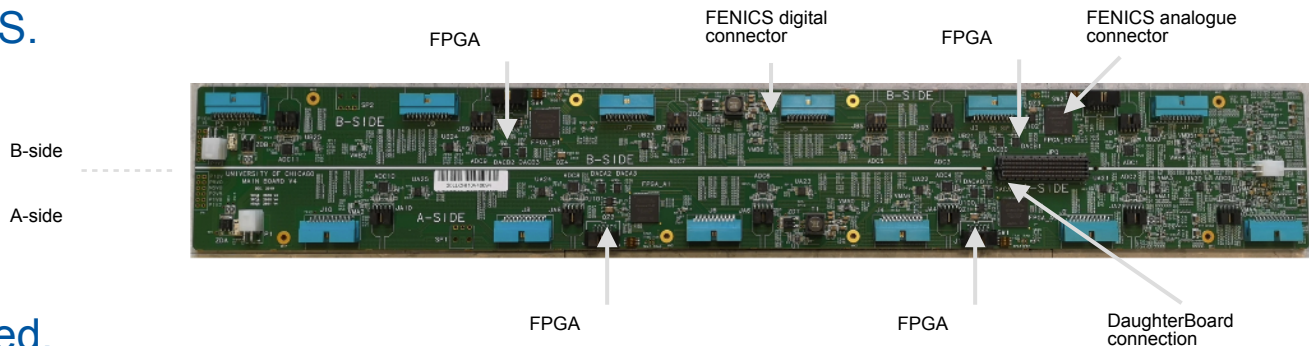

Production completed.

On-detector electronics: The DaughterBoard

Collects the digitised data from the MainBoard.

Interfaces to off-detector electronics through optical links.

Clock and commands recovery and distribution.

- Uses 2 GBTx chips for clock recovery and distribution
- 2 Kintex Ultrascale(+) FPGAs
- 4xSFP high-speed optical modules.

Finalising design before pre-production

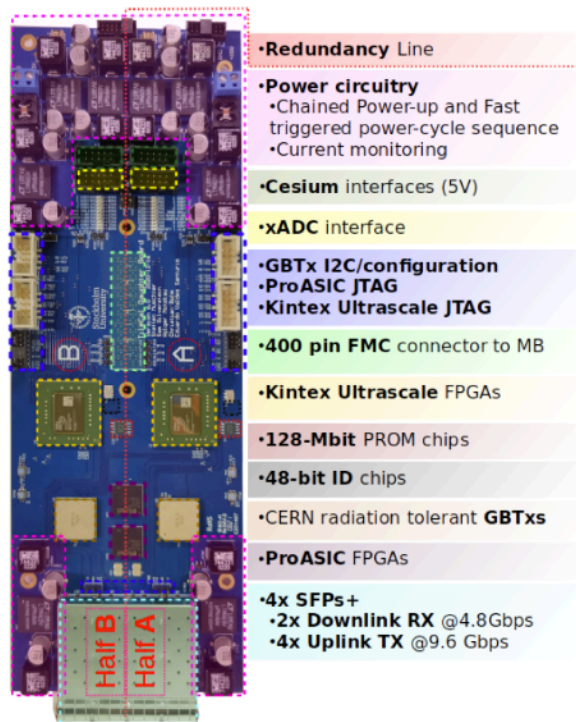

Off-detector electronics

The **Compact Processing Module** (CPM) processes data from 2 modules.

It connects to the Front-end through Samtec Firefly (2Rx +1Tx)x2 for each module.

It transforms the raw data into deposited energy for up to 90 channels at 40 MHz on a Kintex UltraScale (KU115), through optimal filtering.
(Production of v2.1 prototypes ongoing)

The **TDAQi** receives the cell energies from 4 CPMs synchronously.

It builds the trigger primitives, trigger towers or cluster in (η, Φ) .

It sends the trigger objects synchronously to the electron/photon, jet and muon triggers systems.

For the Global trigger, it compares the cell energy with the noise thresholds and send cells above the noise cut (4 or 2 sigma)

It sends the calorimeter data to the FELIX system.

(prototypes being validated)



Compact Processing Module (CPM)

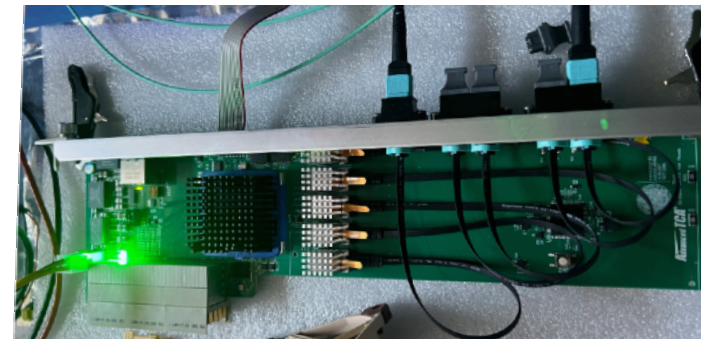

Trigger DAQ interface (TDAQi)

Test-beam at the SPS

8 beam test campaigns were performed in the SPS-H8 beam line between 2015 and 2023 to validate the hardware and perform physics studies. 2024 campaign just started.

Different designs of the front-end electronics have been used over the years.

The setup is partially equipped with new electronics, the remainder with the current electronics.

We used electron, muon and hadron beams, of various energies and the detector positioned in different orientation.

Cherenkov detectors, part of the beam instrumentation allow for particle ID.



TileCal setup in the SPS-H8 beam-line.

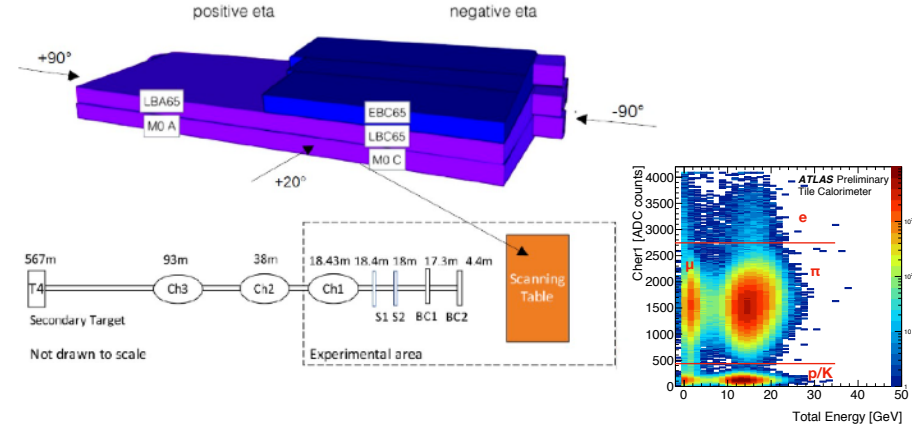

Selected TB results

On top, results from 160GeV/c Muons at 90° angle, with new electronics (May 2018 campaign).

The deposited energy is a function of the path length in each cell.

Layer uniformity within 1%, very good agreement of data and simulations.

It is similar in the two other layers (max deviation 1.4%).

Below, we use electrons to determine the calorimeter response (pC/GeV factors) at EM scale.

We could verify the response linearity and the energy resolution as function of the electron energy.

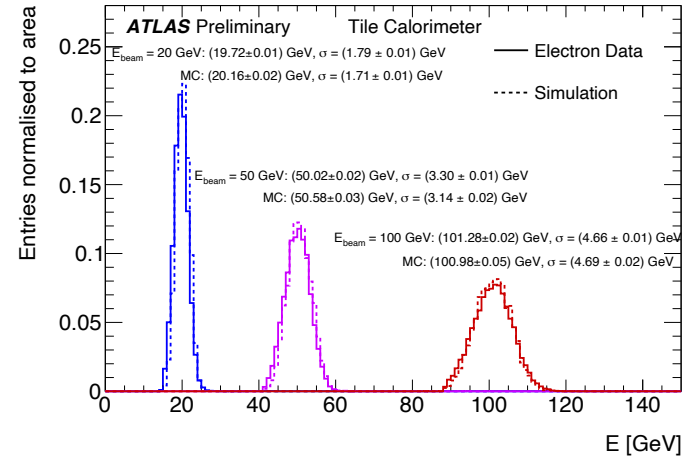
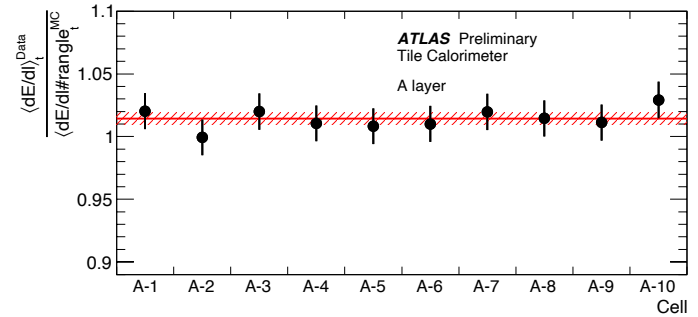

Selected TB results.

The hadron beams are used to check the response for hadrons and improve our understanding of jets and taus in ATLAS.

The beam composition is a mix with a majority of π , K and protons.

$$R^{raw} = \frac{\langle E^{raw} \rangle}{E_{beam}} \quad \Delta \langle E^{raw} \rangle = \frac{\langle E^{raw} \rangle}{\langle E_{MC}^{raw} \rangle} - 1$$

Results for kaons are dominated by statistical errors, while for pions electron contamination plays an important role.

Published in [EPJC 81 \(2021\) 549](#)

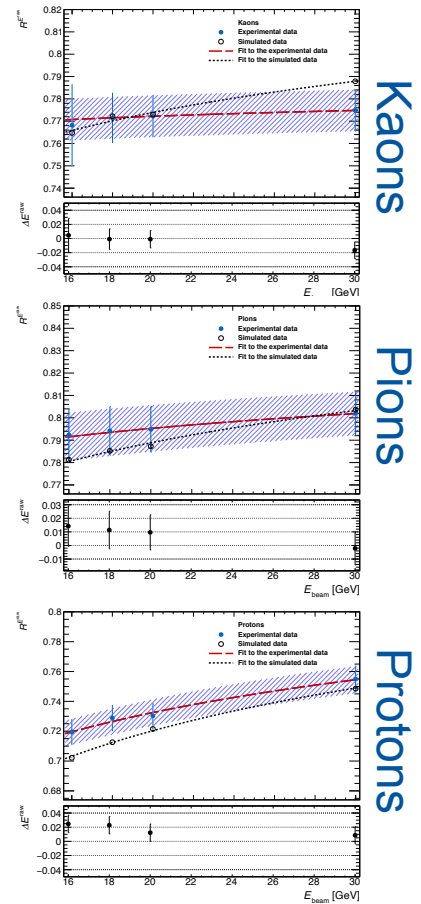

Conclusions

- The Tile Calorimeter continues to operate well through Run-3
- Extensive studies of Run-2 performance have been performed.
 - Further studies on the calorimeter aging are ongoing, but we are confident for the future.
 - Our Run-2 performance paper is in final review by EPJC.
- The HL-LHC area will extend the detector lifetime by decades and bring new challenges:
 - A harsher radiation environment,
 - higher pile-up,
 - higher luminosity and read-out rates.
- For this we will replace all on- and off-detector electronics and 10% of the PMTs in LS3 (2026-2028).
- The TileCal upgrade project is well on track.

Announcement: Michaela Mlynarikova will present how the TileCal concept could be used at the FCC, Wednesday 09:50.