

EUROPEAN ORGANIZATION FOR NUCLEAR RESEARCH

CERN – PS DIVISION

PS/ DI/ Note 98-15 (Tech.)

DIPOLE OF THE CNAO SYNCHROTRON
(Based on the PIMM Study)

*G. Brianti, M. Giesch and S. Rossi**

The final design of the synchrotron dipole magnet for the Italian centre for oncological hadrontherapy (CNAO) is presented. In Appendices A and B are attached the technical specifications of the dipole and the specifications of the low carbon steel used for the yoke. These last documents are ready for tender and complete with drawings.

* CERN and TERA Foundation, via Puccini 11, 28100 Novara, Italy

1 INTRODUCTION

From the beginning of 1992 onwards, the TERA Foundation is engaged in the design and realisation of the hadrontherapy centre CNAO (Italian acronym for National Centre for Oncological Hadrontherapy) based on a synchrotron which can accelerate protons to 250 MeV and carbon ions to 400 MeV/u [1-3]. This will be a centre of excellence devoted to tumour hadrontherapy of more than one thousand patients/year, to clinical research in cancer therapy and to R&D in the fields of radiobiology and dosimetry.

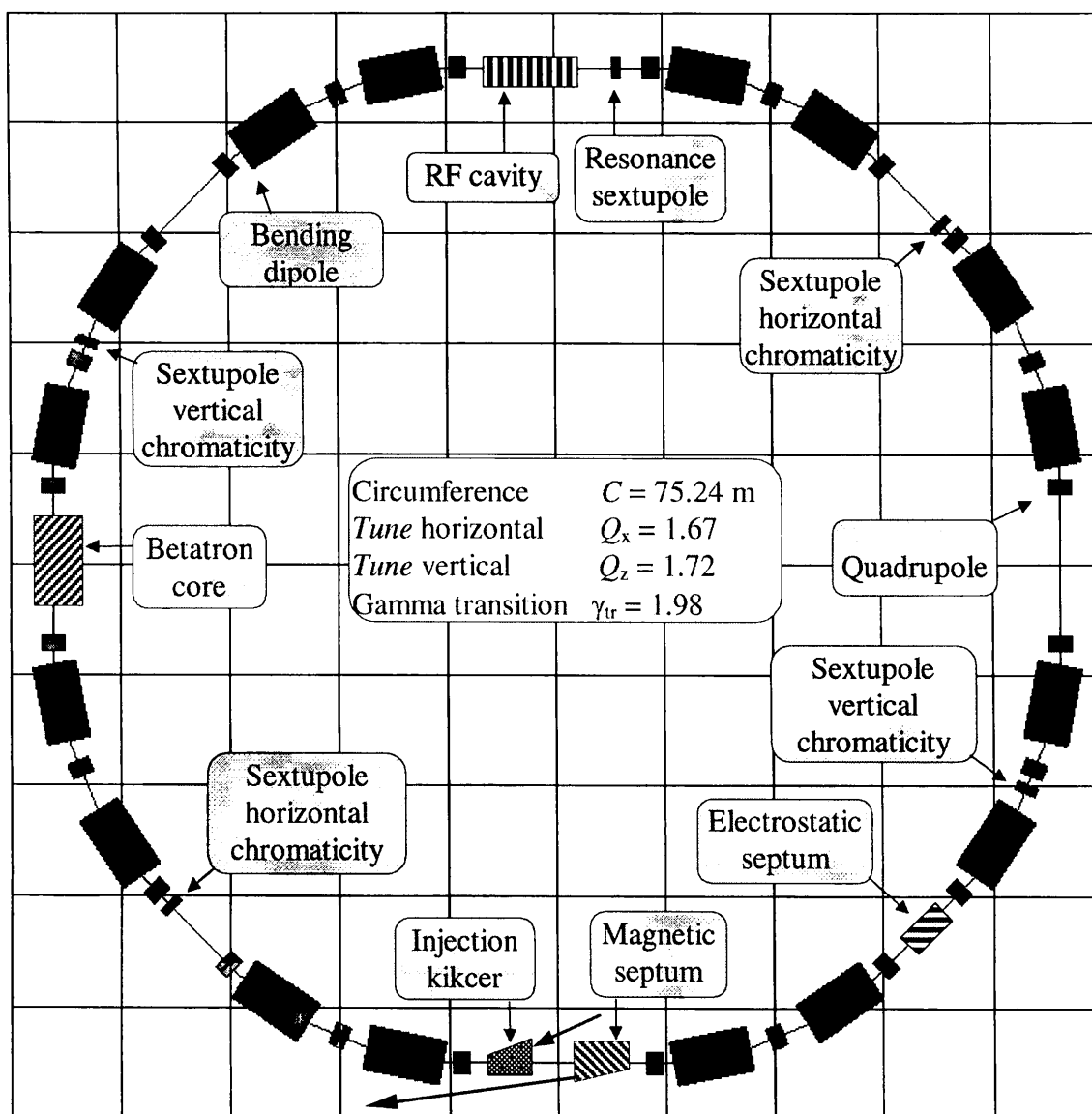

Fig. 1.1 The CNAO synchrotron.

In 1995 CERN management decided to support a small research activity formed of part-time physicists and engineers who, since then, contribute to the design of the medical synchrotron for protons and ions, which will be taken as the heart of the CNAO project. At the beginning of 1996 a new optimised study of such a synchrotron was started at CERN under the leadership of Philip Bryant. The study, denominated PIMMS (*Proton Ion Medical Machine Study*) is supported by a collaboration involving CERN, GSI, Med-AUSTRON and TERA

with the recent intervention of Prague-2000. In Fig. 1.1 is shown a layout of the synchrotron of the CNAO with indication of the main components and parameters.

In this report the final design of the synchrotron dipole magnet is presented. In section 2 the requirements in terms of aperture and good field region are discussed. They are fundamental to set the dipole parameters and the requirements for the power supplies (section 3). In Appendices A and B are attached the technical specifications of the dipole and the specifications of the low carbon steel used for the yoke. These last documents are ready for tender and complete with drawings.

2 APERTURE AND GOOD FIELD REGION

Generally speaking, the beam dimensions at injection determine the vacuum chamber aperture and the good field region in the synchrotron magnets. The adiabatic dumping of the beam sizes during acceleration permits to progressively diminish the dimensions of the good field region and to reduce the influence of the magnet saturation. Instead, in a synchrotron with resonant extraction, the length of the separatrices is constant during the extraction process independently from the beam energy, fixed by the relative distance between the circulating beam and the position of the electrostatic septum for extraction.

In the CNAO synchrotron the electrostatic septum is located at 35 mm, radially outward, from the reference orbit. The beam centre of gravity is displaced toward the internal part of the vacuum chamber to obtain a maximum spiral step of 10 mm. This value has been chosen to optimise the vacuum chamber aperture, the sextupole strength and the losses on the extraction septum. It turns out that the horizontal aperture and good field region are determined by the length of the separatrices, while the vertical aperture and good field region are fixed by the dimensions of the carbon beam at injection.

To fix the aperture of the vacuum chamber the following assumptions have been made [4]:

1. a beam model with uniform distribution in 3D and beam envelope at $\pm \sqrt{5} \sigma$ (σ being the rms value of the distribution);
2. a maximum margin for the horizontal closed orbit distortion of ± 10 mm;
3. a maximum margin for the vertical closed orbit distortion of ± 7.5 mm;
4. a security margin for collimation equal to half the maximum closed orbit margin, i.e. ± 5 mm both horizontally and vertically.

Table 2.1 Aperture and good field region.

<i>Aperture of the vacuum chamber</i>	<i>Half width</i>	<i>Half height</i>
Outside the dipoles [m]	0.070	0.037
Inside the dipoles [m]	0.070	0.032
<i>Good field region</i>	<i>Half width</i>	<i>Half height</i>
Inside the dipoles [m]	0.0600	0.0300
Chamber thickness inside dipoles [mm]	0.4	
Chamber thickness outside dipoles [mm]	2.0	
Vacuum chamber form	'Super-ellipse' $(x/a)^3+(y/b)^3=1$	

In Table 2.1 the aperture of the vacuum chamber and the good field region, internal and external to the dipoles, are presented. Outside the dipoles, the vacuum chamber thickness is equal to 2 mm. Inside the dipoles the chamber thickness is 0.4 mm, to reduce the eddy currents induced by the variation of the magnetic field. In Fig. 2.1 the various contributions to the vertical aperture of the dipoles are presented: beside the chamber aperture and thickness, 2.6 mm are foreseen for the supports to give mechanical strength to the thin chamber and an extra millimetre for alignment.

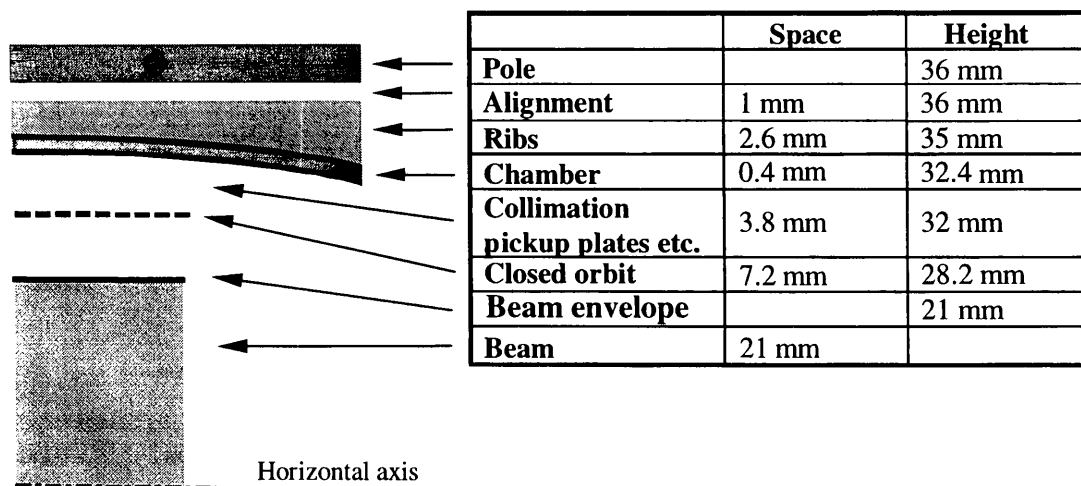

Fig. 3.3 Vertical aperture of the dipole.

During extraction the separatrices have a constant length and extend across the horizontal aperture of the vacuum chamber. Moreover the circulating beam is displaced inside the vacuum chamber at extraction to build the required spiral step and during injection to avoid losses on the extraction septa. The super elliptic form of the vacuum chamber guarantees a sufficient vertical clearance at the extremes of the horizontal aperture together with a bigger mechanical stiffness with respect to a rectangular cross section.

3 DIPOLE DESIGN

The construction parameters of the dipole and the excitation parameters are summarised in Tables 3.1 and 3.2, respectively. In Figs. 3.1 and 3.2 are shown the basic features of the CNAO dipoles. The detailed specifications, including technical drawings are presented in Appendix A. In Appendix B the specifications of the low carbon steel used for the yoke laminations are included.

At the beginning of the study, C-shape dipole and H-shape dipole designs were compared. The study has shown that C-shaped magnet present a volume 40% bigger than H-shaped. In the case of CNAO synchrotron, the injection and extraction lines present enough clearance to allow the the larger transversal dimension of the H dipole. Maybe the field accuracy is also more difficult to reach with the C dipole since the field pattern is not symmetric with respect to the beam central orbit. These considerations have brought to the choice of an H dipole for the CNAO synchrotron.

Table 3.1 Construction parameters of the dipole.

<i>Basic and yoke parameters</i>		<i>Coil parameters</i>	
Max magnetic field [T]	1.5	Number of turns	32
Field at injection (p) [T]	0.091	Conductor dimensions [mm ²]	25×25
Field at injection (C ⁶⁺) [T]	0.180	Coil dimensions [mm ²]	107×107
Bending radius [m]	4.231	Cooling hole diameter [mm]	8
Bending angle [deg]	22.5	Conductor surface [mm ²]	574.7
Magnetic length [m]	1.662	Average turn length [m]	4.252
Gap height [m]	0.072	Cooling circuits	2
Pole width [m]	0.340	Pressure drop [bar]	7
Core length [m]	1.553	Water flow [l/min]	21.6
Overall length [m]	1.893	Initial water temperature [°C]	20
Sagitta [m]	0.081	Temperature rise [°C]	11.3
Lamination width [m]	0.962	<i>Weight</i>	
Lamination height [m]	0.682	Yoke [t]	7.26
Coil window width [m]	0.115	Coil [t]	0.74
Coil window height [m]	0.320	Magnet [t]	8.00

Another characteristic to set in the design was the choice between straight and curved dipole. To make a dipole straight it is necessary to include the sagitta (equal to 81 mm). It means:

- to increase the volume of the gap by 25%, this increases accordingly the inductance and thus the reactive power to run the dipole;
- the coils become 4 % bigger, thus increasing the resistive component of the power;
- the yoke of the dipole is bigger and the dipole heavier;
- the construction of curved dipoles is routinely done and it is not much more expensive than the construction of straight dipoles.

These considerations permit to support the choice of the curved dipole design.

Table 3.2 Excitation parameters of the dipole.

16 units in series	
Resistance per magnet [mΩ]	4.233
Total resistance [mΩ]	67.728
Inductance per magnet [mH]	11.0
Total inductance [mH]	176.0
Time constant (L/R) [s]	2.60
Minimum current [A]	168
Maximum current [A]	2778
Ramping time [s]	0.5
Ramping speed [A/s]	5220
Initial voltage [V]	930
Final voltage [V]	1107
Maximum flat top voltage [V]	188
Peak reactive power [kVA]	2344
Maximum power [kW]	523

Another important aspect to consider is the coil design: a saddle or a flat coil design. Three reasons of practical nature justify the choice of flat coils:

- they are easier to fabricate (cheaper, more firms);
- coils are away from the median plan (no accident due to beam striking them accidentally);
- slightly lower active power is required to run it with respect to saddle coils, due to shorter end connections.

It is under study the possibility to introduce between the two halves of the coil, on the median plane, the connection for the vacuum pump. In this case there will be 16 pumps for the synchrotron.

The required field accuracy across the good field region (120 mm H \times 60 mm V) is of $\pm 2 \cdot 10^{-4}$. This accuracy has to be guaranteed at all field levels, from injection (magnetic field equals 0.091 T) to maximum extraction energy (magnetic field equals 1.5 T). The field uniformity between dipoles, due to remnant field errors, packing factor and length tolerances, has to be within $\pm 1.2 \cdot 10^{-3}$. The field precision / reproducibility is needed to be $\pm 8 \cdot 10^{-5}$ [5].

The ramping and descending time from 0.091 T to 1.5 T and vice versa, has been fixed in 0.5 s to balance between the maximum treatment time (within about 2 - 3 minutes) and the maximum power required. The extraction energy can vary between the minimum energy for protons (60 MeV) and the maximum energy for carbon ions (400 MeV/u). The flat top duration is treatment dependent and could be as long as several second (e.g. respiration-gated synchronisation of the treatment). For ease of operation the same magnetic cycle from minimum to maximum value could be adopted for the synchrotron magnets, independently of the extraction energy, but the availability of a spare magnet, in series with the others, could allow accurate magnetic field measurements thus avoiding the necessity of constant cycling and so reducing the power consumption. The power calculations have been done at the maximum current, justified for a dc magnet and with safety margin that permit to fully exploit the active scanning potentialities.

The uniformity of the extracted spill is critically dependent from the stability of the power supply. It seems appropriate to divide the power supply in two parts: one unit to give the ramping voltage and one unit, less powerful and more precise (i.e. switch-mode power supply), that gives the flat top voltage during extraction. It is also important to note (Table 3.3) that the dynamic range of the power supply is quite large in order to guarantee both for protons and carbon ions good extraction performances.

Table 3.3 Extraction conditions for protons and carbon ions.

	Voltage [V]	Vmax/Vflat-top.
Maximum voltage	1107	1
Flat top voltage C ⁶⁺ @ 400 MeV/u	188	5.9
Flat top voltage C ⁶⁺ @ 120 MeV/u	96	11.5
Flat top voltage p @ 250 MeV	72	15.4
Flat top voltage p @ 60 MeV	34	32.6

The dipoles are laminated. The thickness of the lamination is equal to 1.5 mm and it is required to minimise the induced currents in the dipole yoke. The laminations are held together by welded bars on the external contour of the magnet. In the design presented here the upper and

lower halves are also held together by welded bars. An alternative could be the use of bolted bars; this could make easier the magnetic measurements of the dipoles with and without the vacuum chamber in place. Also, it could be possible to unbolt the upper half of the dipole to extract the vacuum chamber without losing the alignment of the dipole.

The design of the dipoles is the result of a 2D calculation. This approach is fully justified by the small disturbance created by the end fields. In order to take into account these effects on the beam a shim has been added to the pole profile. An accurate field measurement of the field will give the needed information to shape the shim accordingly.

4 ACKNOWLEDGEMENTS

The authors have benefited from discussions with P. Bryant and the PIMMS Group and also with the Frascati - INFN Team.

5 REFERENCES

- [1] U. Amaldi and M. Silari eds, *The TERA Project and the Centre for Oncological Hadrontherapy*, Second edition, INFN-LNF, Frascati (1995) – Blue Book.
- [2] U. Amaldi ed, *Il Centro Nazionale di Adroterapia Oncologica a Mirasole*, INFN-LNF, Frascati (1997) – Red Book.
- [3] U. Amaldi and S. Rossi eds, *Il Centro Nazionale di Adroterapia Oncologica a Mirasole: sincrotrone e linee di trasporto*, CERN, Geneva (1998) – Addendum to Red Book.
- [4] PIMMS Group, *PIMMS Aperture Specifications*, presented in a PIMMS seminar, CERN (February 1997).
- [5] P.J. Bryant, *Field Quality, Field Setting and Mechanical Tolerances*, presented in a PIMMS seminar, CERN (February 1997).

Distribution :

U. Amaldi	K. Hübner
L. Badano	P. Knauss
M. Benedikt	A. Maier
G. Borri	K. Prokes
P. Bryant	M. Pullia
M. Crescenti	M. Regler
P. Holy	D.J. Simon

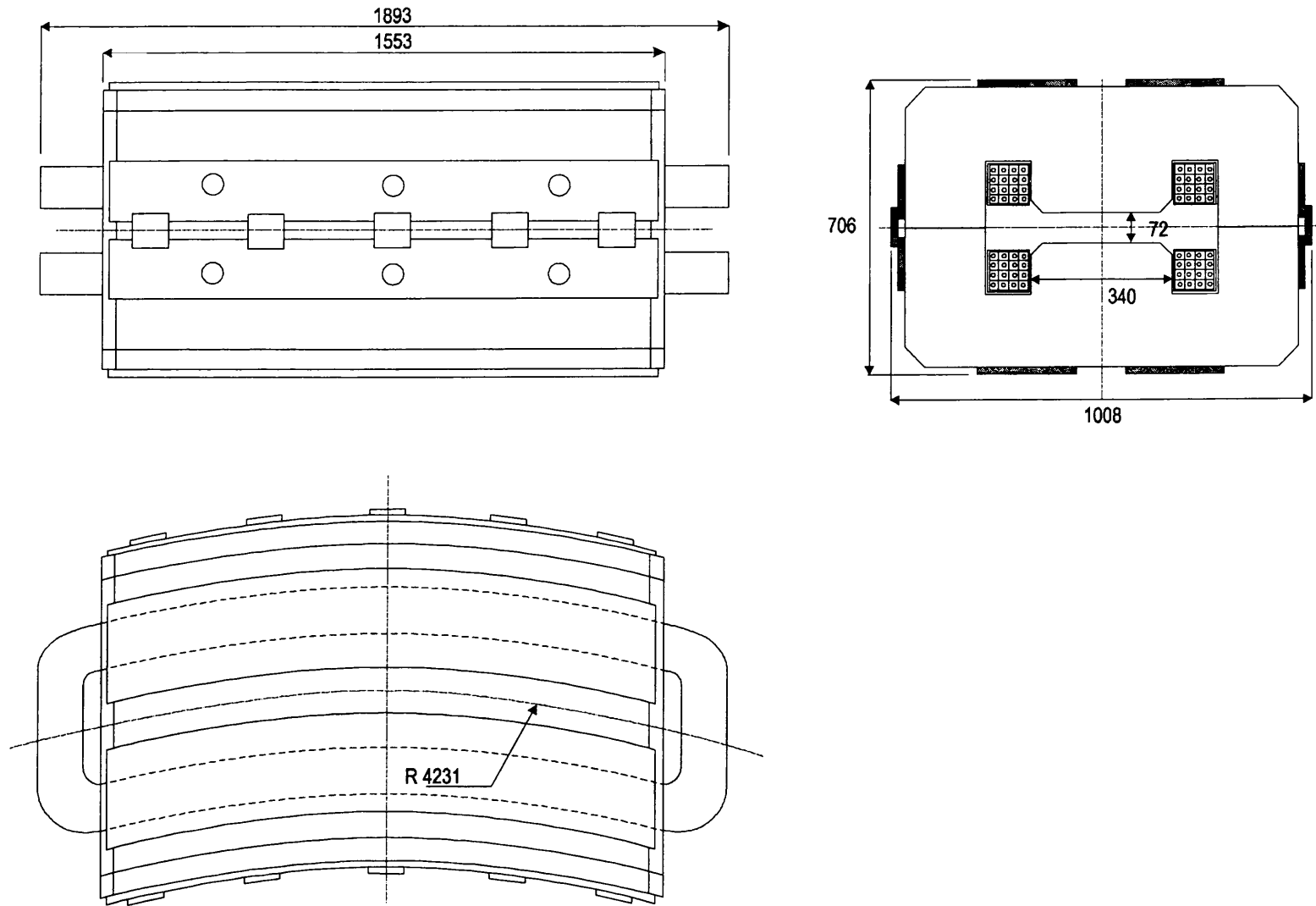

Fig. 3.1 Geometry of the CNAO dipole (all dimensions in mm)

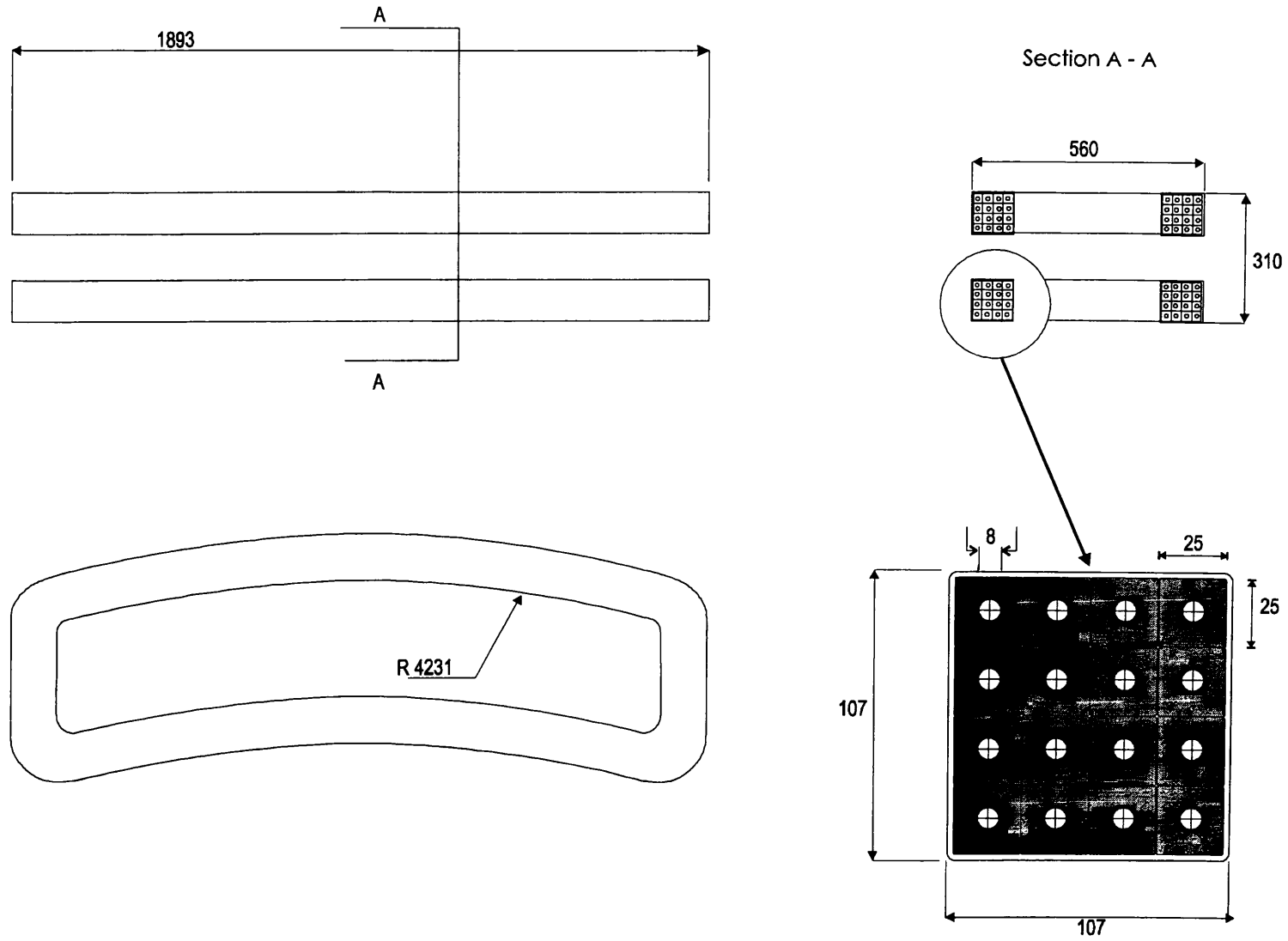

Fig. 3.2 Coil geometry of the CNAO dipole (all dimensions in mm)

APPENDIX A

TECHNICAL SPECIFICATION

CNAO SYNCHROTRON MAIN DIPOLE

INDEX

- 1 INTRODUCTION, SCOPE AND RESPONSIBILITIES
 - 1.1 Introduction
 - 1.2 Responsibilities and reserves made by TERA
 - 1.2.1 Responsibilities
 - 1.2.2 Modifications to the specification
 - 1.2.3 Inspection and tests
 - 1.3 The main dipole magnets
 - 1.4 List of drawings
 - 1.5 Steel sheet supply
- 2 FABRICATION OF THE STACKS
 - 2.1 General
 - 2.2 Punching of the laminations
 - 2.3 The glued end-stacks and end shims
 - 2.4 Mixing of the laminations
 - 2.5 Assembly of the stacks
 - 2.6 Tolerances concerned with the finished stacks
 - 2.7 Corrosion protection
- 3 FABRICATION OF THE EXCITATION COILS
 - 3.1 Conductor material and dimensions
 - 3.2 Coil winding
 - 3.3 Electrical ground insulation of the coil
 - 3.4 Test of the finished coil
 - 3.4.1 Mechanical tolerances
 - 3.4.2 Hydraulic tests
 - 3.4.3 Electrical tests
 - 3.4.4 Insulation tests
- 4 MAGNET ASSEMBLY
 - 4.1 Assembly of the magnetic circuit
 - 4.2 Mounting of the coils
 - 4.3 Electrical and water connections
 - 4.4 Thermal protection
- 5 TESTS ON THE COMPLETE MAGNETS
 - 5.1 Mechanical dimensions
 - 5.2 Leak and water flow tests
 - 5.3 Electrical tests
 - 5.4 Test protocols
- 6 MISCELLANEOUS
 - 6.1 Technical information to be communicated
 - 6.2 List of samples to be furnished for approval
 - 6.3 Transport and precautions to be taken
 - 6.4 Guarantee

1 INTRODUCTION, SCOPE AND RESPONSIBILITIES

1.1 Introduction

Since the beginning of 1992, the TERA Foundation is engaged in the design and realisation of the hadrontherapy centre CNAO (Centro Nazionale Adroterapia Oncologica) based on a synchrotron which can accelerate protons to at least 250 MeV and carbon ions to at least 400 MeV/u This will be a centre of excellence devoted to tumour hadrontherapy of more than one thousand patients per year, to clinical research in cancer therapy and to R&D in the fields of radiobiology and dosimetry.

At the end of 1995 the TERA Foundation has drawn the interest of CERN for the design of an optimised synchrotron for light ion therapy. Such a machine could then be built nationally by those European countries who will decide to invest the needed funds. At the beginning of 1996, the CERN management agreed, and a new optimised study of such a synchrotron was started at CERN (PIMMS = Proton and Ions Medical Machine Study) in the framework of a collaboration involving also GSI ,Darmstadt and Med-AUSTRON,Vienna.

In 1998 the TERA Foundation has started the specification phase of the main components. This technical specification represents the first of the series and is concerned with the fabrication and testing of the resistive dipole magnets which will be used in the CNAO synchrotron.

1.2 Responsibilities and reserves made by TERA

1.2.1 Responsibilities

1.2.1.1 TERA define here after the design, materials, fabrication methods and criteria for test and acceptance of the CNAO dipole magnets.

1.2.1.2 After acceptance by both parties of this specification, the manufacturer shall supply two sets of fabrication drawings to TERA. Written approval from TERA shall be obtained before starting fabrication of the first magnet. The drawing will be made according to the TERA drawing standard. The drawings will be supplied in paper and in electronic format such as to allow their filing in the TERA drawings Directory Server. However, approval from TERA does not relieve the manufacturer from its liability to accept full responsibility to supply magnets conform to the performance and requirements defined in this specification.

1.2.2 Modifications to the specification

All modifications to this specification need the written approval by TERA.

1.2.3 Inspections and tests

TERA reserves the right to witness all tests described in this specification. Therefore, TERA must be notified at a suitable time before the tests. TERA's inspector must have free access at any normal time to the production premises of the manufacturer and to the relevant parts of the factories of its sub-contractors. Each magnet shall be delivered with written certificates, established between TERA and the manufacturer.

1.3 The main dipole magnets

The dipoles are assembled from two halves, each with a pre-assembled excitation coil. The cross section is shown in Figure 1.

The stacks are made from precision punched laminations held together by glued end-stacks and welded tension plates.

The excitation coils are wound from hollow copper conductor, insulated with glass tape and impregnated with a radiation resistant epoxy resin.

The quality of the field distribution is ensured by the close tolerances imposed on the pole profile, on the assembly of the magnets and on the properties of the steel.

The main characteristics are listed in Table 1.

Table 1 Main characteristics of the main dipole magnet

Nominal flux density	1.5	[T]
Gap height	72	[mm]
Pole width	280	[mm]
Core length	1553	[mm]
Max. overall width	1008	[mm]
Max. overall length	1893 ⁺³	[mm]
Excitation current	2778	[A]
Total weight	8000	[kg]
Required number of magnets	16 + 2 ?	
Field Quality: $ \Delta B / B_0 $, $ \int \Delta B dl / \int B_0 dl $	$\pm 2 \cdot 10^{-4}$ over $x = \pm 60$ mm	
	and $y = \pm 30$ mm for the	
	whole range of field levels:	
	0.15 T < B < 1.50 T	

1.4 List of drawings

The drawings listed in Table 2 form part of the Technical Specification.

Table 2 Drawings of the main dipole magnet

Figure	Magnet	Drawing name	TERA drawing number
Figure 1	M.D.	Cross section	
Figure 2	M.D.	Lamination	
Figure 3	M.D.	Glued end-stack	
Figure 4	M.D.	Stack	
Figure 5	M.D.	Assembly	
Figure 6	M.D.	Coil	
Figure 7	M.D.	Coil assembly	

1.5 Steel sheet supply

The steel sheet to be used for the laminations of the magnet will have a nominal thickness of 1.5 mm. The magnetic properties of the steel sheet are described in the document: “Specification of the Steel Sheet for the CNAO Resistive Magnets”.

The external dimensions of the steel sheet will depend on the envisaged punching procedure and the number of laminations punched per sheet. They must allow for a sufficient margin for accurate punching of the contour and for the removal of undesirable wedge shaped regions at the edges. On the sides parallel to the rolling direction of the sheets, margins of 10 mm have been found adequate. This conditions holds also for the other sides.

Blue steaming shall insolate the steel sheet.

2 FABRICATION OF THE STACKS

2.1 General

The assembly of a stack is shown in Figure 4. The tension plates are welded along the length of the stack. They hold the glued end stacks and the laminations together.

2.2 Punching of the laminations

The lamination with its dimensions and tolerances is shown in Figure 2. Before starting the production of the laminations and after each re-shaping of the dies, a certain number of laminations shall be punched and three of them shall be measured. In addition, each thousandth lamination of the production run shall be measured. The burr must not exceed 0.06 mm.

TERA may take sample laminations at any time for inspection. If any of these fail to meet specification and tolerance requirements, all laminations punched since the last accepted samples may be rejected.

2.3 The glued end stacks and end shims

Stacks of glued laminations are used as end plates. Dimensions and tolerances are given in Figure 3. A radiation resistant epoxy resin must be used for gluing. Each lamination has to be independently treated with resin before gluing the laminations together.

End shims (pos.2 in Figure 3), screwed to the glued stacks, are used to improve the magnetic field distribution. The final shape of these shims will be determined after magnetic measurements on the first magnet.

2.4 Mixing of the laminations

In order to improve the uniformity of the magnetic properties of the stacks, the laminations must be mixed before stacking. For this purpose, the laminations will be arranged in a certain number of equal piles each containing an equal number of laminations. The laminations are chosen such that each stack contains approximately the same number of laminations from each of the piles. The number of piles to be used should not be less than 20.

2.5 Assembly of the stacks

End plates and laminations must be stacked and contained in a rigid frame having a curvature of 4.231 m radius. Stacking shall be done against the reference surfaces indicated in Figure 2, the drawing of the lamination. Stacking has to be performed in the horizontal plane, i.e. in the final position of the dipole yoke.

The packing factor of the stacks shall not deviate by more than ± 0.1 % from its nominal value. This will be achieved by weighting the necessary quantity of laminations to this precision. The nominal packing factor will be determined during fabrication of the first stack. It must be equal or larger than 97 %.

The stacking fixture must allow stacking to a precision of 0.05 mm total range. The stacking fixture must be adequately supported such that it maintains its flatness during the stacking under the added weight. The stacking fixture must be designed to allow inspection of the edge of the mating surfaces of the completed stacks.

During the stacking, groups of 20 laminations shall be turned alternatively around their vertical axis. This has to be done in order to compensate partially for the systematic geometrical errors of the lamination.

The laminations must be uniformly distributed throughout the length of the stack by compressing the stack at 0.5 m intervals during the stacking process. The compression force shall be 100 kN.

2.6 Tolerances concerned with the finished stacks

After welding, the dimensions and tolerances of the stacks must be checked. The check may be done on the stacking fixture.

The stacks must, however, first be removed from the fixture and then replaced so that both ends are accessible for measurements.

- The length must be measured near the poles. The tolerance for this length is ± 0.5 mm with respect to the nominal length.
- The end stacks must be perpendicular to within ± 1 mm.
- Deformations of the stacks resulting from twist and errors in straightness must not be larger than ± 0.1 mm.
- The measurements must be done along the upper reference surfaces using an optical method. Alternatively, the gap between the mating surfaces and the stacking fixture can be measured with feeler gauges, whilst the stack is loaded with at least 5 kN/m

2.7 Corrosion protection

The cores, with exception of the poles and the mating surfaces, must be painted with at least one coat of suitable primer and a radiation resistant paint. The painted surfaces must not show any sign of degradation (e.g. fissures, blisters, etc.) up to a radiation dose of 10^7 Gy (10^9 rad)

3 FABRICATION OF THE EXCITATION COILS

3.1 Conductor material and dimension

The conductor shall be made from electrolytic oxygen free copper, having a minimum conductivity of $58 \times 10^6 \Omega^{-1} \text{m}^{-1}$ at 20°C . Dimensions and tolerances of the conductor are given in Figure 6.

The internal and external surfaces of the conductor must be clean and free from fissures and burr. It must also be verified that the hole is not obstructed and that the conductor is leak tight.

Due to the small radius of curvature of the conductors at the ends, machining of the conductor is necessary after bending it to adjust the conductor shape.

3.2 Coil winding

All winding and insulation operations shall take place in an environment free of metallic dust or other contaminants. All coil components (conductor, insulating materials, filler pieces) and tools must be handled so as to prevent any contamination by oil, dirt, moisture, metallic particles, etc.

The conductor shall be insulated with a glass-fibre tape of E-type, with a surface finish suitable for its bonding with impregnation resin.

The thickness of the conductor insulation shall not exceed 0.5 mm. The conductor shall be carefully sandblasted, degreased and cleaned immediately before the insulation is applied.

Each coil winding has to be realised with a single conductor length, without junctions.

3.3 Electrical ground insulation of the coil

The electrical insulation to ground of the coil is made by wrapping a glass-fibre tape around the coil assembly. The glass-fibre must be of E-type and have a surface finish suitable for its bonding with impregnation resin. The empty spaces must be filled with a conveniently shaped glass-fibre laminate and/or a glass-fibre fabric having a good adhesion with impregnating resin.

The coil is placed in a mould; it must be dried, evacuated and impregnated under vacuum with a suitable thermosetting epoxy resin. The mould must then be tightened to confine the coil to its final dimensions and heated to polymerise the complete insulation.

The final thickness of the insulation to ground, after coil impregnation and polymerisation, must be 1.5 mm. Pure resin thickness in excess of 0.5 mm is not admitted. To avoid the build-up of resin layers on top of the glass-fibre tape, it is suggested to use Tedlar™ tape along the straight parts and the coil heads as release agent.

The choice of impregnation resin, curing agent, accelerator and of the curing cycle should be made in agreement with TERA. The following point must be observed:

- all components (resin, harder, etc...) used for impregnation must come from the same firm;
- the viscosity of the resin and the process of impregnation must be chosen such as to allow a thorough resin penetration between turns;
- the resin must be radiation resistant. It is required that the flexural strength measured on irradiated samples after being exposed to an integrated dose of 10^7 Gy (10^9 rad) is not less than 50 % of the value measured on non-irradiated samples. Samples of the resin system must be submitted to TERA;
- 30 samples of size 80 mm x 10 mm x 3 mm;
- the impregnation process has to be performed in a closed mould to guarantee the coil shape.

3.4 Test of the finished coil

Each coil shall be given a serial number, indicated on a label fixed at the coil end. The result of all tests on each coil shall be recorded together with its serial number.

3.4.1 Mechanical tolerances

The length, height, width, straightness and curvature of the coils shall be measured with an appropriate measurement jig, which allows to check immediately if the coil may be fitted to the magnetic circuit and does not exceed the allowed overall size.

3.4.2 Hydraulic tests

A flow test shall be made on both cooling circuits of the finished coil. At a pressure drop of 7 bar the water flow shall exceed 10.5 l/min for each cooling circuit.

A pressure test shall be made at 30 bar during 15 minutes.

3.4.3 Electrical test

The electrical resistance of each finished coil shall be measured. The resistance between the two electrical terminals must not exceed 2.2 m Ω at 20 °C.

3.4.4 Insulation tests

Each coil shall be immersed in water at ambient temperature for at least 6 hours. Its terminals shall be over water. An insulation test will be made with an a.c. voltage of 6.0 kV rms, 50 Hz applied between the water and the coil for one minute.

The resistance between the conductor and the water will be measured before and after the a.c. test with a voltage of 2.5 kV d.c. The measured values shall exceed 10⁸ Ω .

Immediately after these tests, the inter-turn insulation will be checked. A voltage of 750 V rms must be applied between the terminals of each coil. This can be done either with a capacity discharge or by using the coil as an open secondary of a transformer. The final procedure must be chosen in agreement with TERA.

4 MAGNET ASSEMBLY

4.1 Assembly of the magnetic circuit

The two stacks with their pre-assembled coils must be carefully aligned in an assembly jig and welded together. Special care must be taken that the resulting dipole is as symmetrical as possible. Tolerances must again be verified on the finished dipole.

4.2 Mounting of the coils

Elastic pads of appropriate thickness must be inserted between the core and the coils to take up the surface irregularities and to allow for thermal expansion. The pads must be made from polyurethane or ethylene-propylene rubber. As indicated in Figure 1, blocks of Vetronite™ combined with polyurethane rubber sheets are used to press the coils against the yokes. The thickness of the rubber sheets must be determined by measurements on the stack/coil pre-assembly. These blocks shall be placed at 250 mm interval along the length of the magnet.

4.3 Electrical and water connections

Electrical and water connections are shown in Figure 7. Electrically the two coils are in series. They are connected to two terminals mounted below the magnet where the external power

cables arrive. Each coil has two cooling circuits. A glass-fibre manifold will be used for the water distribution.

4.4 Thermal protection

Each magnet must be equipped with two thermal switches fixed to the non-connection end of the coils. They have to open at a temperature of 60 °C with a tolerance of ± 3 °C. The fixation method must be agreed between TERA and the manufacturer.

5 TESTS ON THE COMPLETE MAGNET

5.1 Mechanical dimensions

Every completed magnet must have its dimensions checked. For this purpose, the dipoles have to be aligned horizontally.

The straightness shall then be measured along the upper reference surfaces. The straightness shall not deviate by more than 0.25 mm from the theoretical value.

5.2 Leak and water flow tests

The complete cooling circuit will be checked for leaks using water pressure of 30 bar, applied for at least 15 min. A flow test shall also be made. For a water pressure of 7 bar, the water flow shall exceed 42.0 l/min.

Directly following these tests, the water remaining in the cooling circuits must be completely evacuated in order to avoid damage due to freezing.

5.3 Electrical tests

The electrical resistance of the dipoles will be measured between the two electrical terminals. It shall not exceed 4.4 m Ω at 20 °C.

The resistance between the magnet terminals and the grounded core will be measured with 2.5 kV d.c. voltage. The resistance must not exceed 10⁸ Ω .

5.4 Test protocols

All test results shall be recorded together with the serial number of the magnet, the half cores and the coils.

6 MISCELLANEOUS

6.1 Technical information to be communicated

It is requested that TERA shall be informed about all technical details of the construction.

The following list summarises all information demanded by TERA in its magnet contracts.

1. Data on the construction materials
 - Steel for laminations, tension plates and end shims
 - Insulating materials, resins and tapes
2. Data on the manufacturing process
 - Curing cycle for the resin
 - Welding and brazing processes
 - Assembly methods
3. Drawings before production has started (for approval)
4. Time schedule of manufacture followed by regular progress reports
5. Any technical modifications with respect to the present specification (for approval)
6. Three complete sets of final drawings (for internal use at TERA)
7. All test certificates

6.2 List of samples to be furnished for approval

6.2.1 Steel samples

- A number of rings (outer diameter 114 ± 0.1 mm; inner diameter 76 ± 0.1 mm) cut out of the steel sheets.
- A number of punched laminations as stated in Section 2.2.

6.2.2 Insulation samples

- Samples of the tapes used for conductor and ground insulation.
- Samples of the resin for radiation resistance tests (pure resin).

6.3 Transport and precautions to be taken

6.3.1 It is the responsibility of the manufacturer to deliver all magnets well protected and without damage to a site to be indicated by TERA.

6.3.2 All cooling ducts must be dried out properly and closed off in order to avoid damage by frost.

6.3.3 Parts sticking out of the magnet core, especially coil heads, vacuum chamber and magnet connections have to be protected by (mechanically) rigid covers.

6.3.4 The whole magnet shall be covered with protective plastic foil.

6.3.5 In order to avoid deformation and permanent damage, closed solid transport structures (containers) should be used. Several magnets may be transported in the same container.

6.4 Guarantee

TERA has the right to reject all magnets which were found to be faulty during the guarantee period, namely magnets that would no longer pass all acceptance tests as foreseen in the present Technical Specification. The guarantee lasts at least two years after the acceptance tests.

APPENDIX B

TECHNICAL SPECIFICATION

**SPECIFICATION OF THE LOW CARBON STEEL SHEET
FOR THE CNAO SYNCHROTRON MAIN DIPOLE**

1 INTRODUCTION

This specification covers the properties of the steel for the magnets of the CNAO synchrotron.

It will be the responsibility of the magnet manufacturer to place a contract for the supply of the low carbon steel. The manufacturer must check all mechanical characteristics of the steel sheet supply and must carry out the acceptance tests concerning the magnetic properties of the steel sheet, as laid down in this specification.

2 TYPE OF STEEL

2.1 Low carbon content

The steel sheet for the construction of this type of magnets must have a low coercivity and a high saturation induction. This requires the use of a low carbon steel with a low content of impurities.

Experience obtained in the construction of similar magnets indicates that a substantial improvement of the low-field permeability and of the coercivity can be obtained by a combination of suitable annealing treatments and cold reductions, which further reduce the carbon content and increase the grain size. The magnetic characteristics indicated in these specifications have been previously achieved on this type of cold rolled, low carbon steel sheet.

2.2 Insulating surface layer

The steel sheet should be blue steamed in order to obtain an insulating surface layer. The surface resistance has to be $> 50 \text{ m}\Omega / \text{cm}^2$. This corresponds to a Fe_3O_4 layer of about 6 to 10 μm .

3. MAGNETIC PROPERTIES OF THE STEEL SHEET

3.1 Coercivity

The coercivity value H_c here after specified is the value of the magnetising field which reduces the induction in the steel to zero from the value existing after complete saturation. The values of the coercivity through the whole delivery (measured on samples as indicated in 3.4) must stay within an interval of $\pm 12 \text{ A/m}$ with respect to a normal value proposed by the steelmaker. This nominal value must be as low as possible, and in any case lower than 80 A/m.

3.2 Permeability

The required values of the permeability, i.e. the ratio of the magnetic induction B (in Tesla) to the applied field H (in A/m) measured at points along the normal magnetisation curve, and their permissible spread are usually specified, for the purpose of magnet design, as a function of the induction B .

In order to facilitate measurements, the following equivalent specification of the induction B as a function of the field H is given:

Field Strength [A/m]	Induction [T]
40	>0.1
120	>0.7
1000	>1.5
10000	>1.8
25000	>2.0

3.3 Ageing

In principle, the steel supply should be entirely stable with respect to time in both coercivity and permeability. Since the operating temperature of the magnet cores is expected not to exceed 25°C, stability of the magnet properties refers to many years of operation at his temperature.

As a practical criterion, it is proposed that the ageing properties of the sheet are evaluated by remeasuring the coercivity after 100 hours accelerated ageing at 150°C on the samples submitted by the steel maker from a pre-production quantity of the low carbon steel sheet. The measured values on the aged samples should not exceed the limits specified on section 3.1 by more than 8 A/m

Similar measurements will be repeated on samples from the full-scale production of the steel sheet. The results of these measurements should meet the same specification. It is not proposed to perform systematic ageing test throughout the delivery, but it is expected that the constancy of the ageing properties will be ensured by the constancy of the chemical composition and by the reproducibility of the production process. Therefore, the results of the chemical analysis carried out by the steel-maker on each batch of steel and the records of the processing shall be made available to TERA. The relevant tolerances should be proposed by the steel-maker and agreed by TERA before proceeding with the full-scale production of the steel sheet.

3.4 Procedure for magnetic measurements

The magnetic properties of the steel have to be tested by the manufacturer by systematic measurements on samples taken throughout the delivery.

Samples shall be taken from each batch of steel in its final condition prior to delivery and the batch should not be permitted to enter the stores for core making until the samples have been tested.

The representative of the manufacturer should be present during the preparation of samples by the steel-maker.

The samples shall be rings with the following dimensions:

- Inner diameter 76 ± 0.1 mm
- Outer diameter 114 ± 0.1 mm

The detailed sample arrangements for the performance of the magnetic tests and the insulation test will depend on the form of the steel provided and will be decided by agreement

between the steel-maker, the manufacturer and TERA. In any event the maximum amount of steel from the production used in this way will not exceed 0.1%.

It is proposed that the results of the measurements by the manufacturer shall be submitted to the steel-maker. Unless an objection is made within fourteen days after receipt of the data, it will be assumed that the steel-maker accepts the results. Subsequently, these figures will be used for the purpose of acceptance and rejection of steel sheet. In the event of an irresolvable dispute about the results of the measurements, a neutral institution will be appointed to arbitrate.

4. GEOMETRICAL AND MECHANICAL PROPERTIES OF THE STEEL SHEETS

The detailed specifications and the acceptance procedures will have to be established by the manufacturer and must be agreed upon by the steel maker, the punching firm and TERA.

4.1 General

In order to maintain constant magnetic characteristics, no mechanical processing of the steel sheet, with the exception of punching, can be permitted after the sampling for magnetic measurements.

As a general requirement, the steel sheets in their final condition must be suitable for precision punching and for assembling straight stacks with a large packing factor.

4.2 Flatness and internal stresses

The sheets should be flat and free of internal stresses in order to avoid local perturbations in the stack and movements of the gap profile after punching.

Although the acceptance criteria and tests will be the responsibility of the manufacturer, the following methods, which are based on TERA experience, are suggested:

- when a sheet of dimensions 500 x 1000 mm² is laid on a marble, the distance from any point of the upper face to the marble must be smaller than 2.5 mm.
- when a sheet is freely suspended, the sagitta in the rolling direction measured over a length of 1000 mm must be smaller than 10 mm..

4.3 Thickness

The average thickness of the steel sheets contained in each delivery pallet (assumed ~ 2 tons) must be maintained within an interval of ± 0.03 mm of the nominal value of 1.5 mm (as determined by weight).

The thickness of each individual steel sheet shall be kept within ± 0.09 mm of the nominal value of 1.5 mm as measured at any point of the sheet.

The spread in thickness transverse to the rolling direction shall be kept within ± 0.05 mm inside the region limited by two lateral strips of 10 mm width.

4.4 Surface quality

The surface of all sheets must be smooth. Flaws, cores and small pits, which should only be isolated ones, must not exceed the permissible thickness variation. The surface roughness shall be in the range 0.3 to 2 μm Ra (ISO/R4689).

4.5 Inspection

It should be the responsibility of the punching firm to perform adequate geometrical tests of the steel sheets during production and to define, in agreement with the steel-maker, the precise methods of inspection. The manufacturer is responsible that controls are made correctly.

TERA must be informed about the methods of inspection, which have been agreed upon. The results must be made available to TERA.

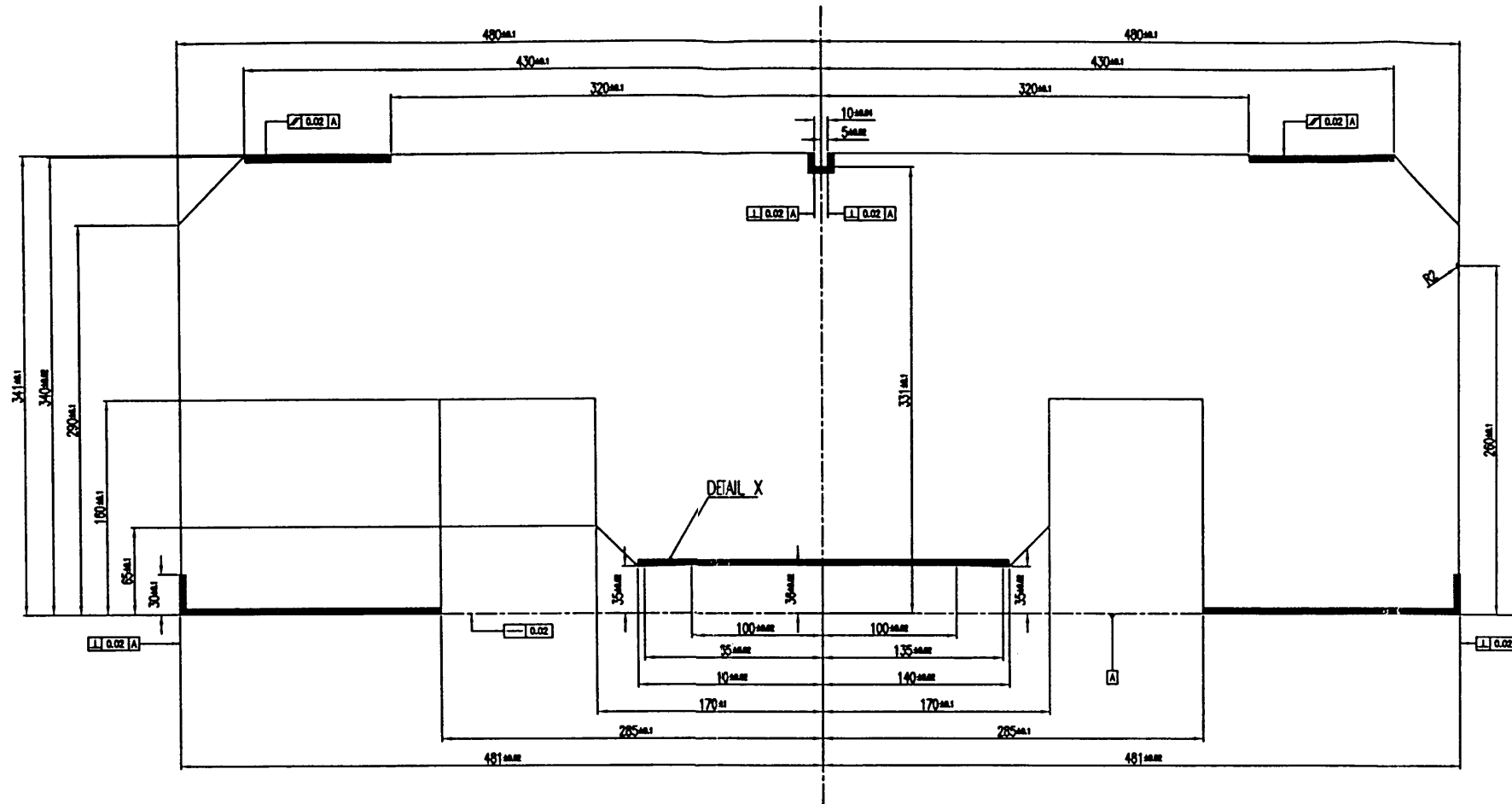

THICKNESS OF LAMINATION 1.5 mm
 SURFACE OF LAMINATION 275300 mm²

Fig. 2

GENERAL REMARKS: ALL DIMENSIONS ARE IN MILLIMETERS UNLESS OTHERWISE SPECIFIED.
 DIMENSIONS ARE TO BE TAKEN TO THE CENTERLINE OF THE DIMENSIONED PARTS.
 DIMENSIONS ARE TO BE TAKEN TO THE CENTERLINE OF THE DIMENSIONED PARTS.
 DIMENSIONS ARE TO BE TAKEN TO THE CENTERLINE OF THE DIMENSIONED PARTS.
 DIMENSIONS ARE TO BE TAKEN TO THE CENTERLINE OF THE DIMENSIONED PARTS.

1. DIMENSIONS ARE TO BE TAKEN TO THE CENTERLINE OF THE DIMENSIONED PARTS.
 2. DIMENSIONS ARE TO BE TAKEN TO THE CENTERLINE OF THE DIMENSIONED PARTS.
 3. DIMENSIONS ARE TO BE TAKEN TO THE CENTERLINE OF THE DIMENSIONED PARTS.
 4. DIMENSIONS ARE TO BE TAKEN TO THE CENTERLINE OF THE DIMENSIONED PARTS.
 5. DIMENSIONS ARE TO BE TAKEN TO THE CENTERLINE OF THE DIMENSIONED PARTS.
 6. DIMENSIONS ARE TO BE TAKEN TO THE CENTERLINE OF THE DIMENSIONED PARTS.
 7. DIMENSIONS ARE TO BE TAKEN TO THE CENTERLINE OF THE DIMENSIONED PARTS.
 8. DIMENSIONS ARE TO BE TAKEN TO THE CENTERLINE OF THE DIMENSIONED PARTS.
 9. DIMENSIONS ARE TO BE TAKEN TO THE CENTERLINE OF THE DIMENSIONED PARTS.
 10. DIMENSIONS ARE TO BE TAKEN TO THE CENTERLINE OF THE DIMENSIONED PARTS.
 11. DIMENSIONS ARE TO BE TAKEN TO THE CENTERLINE OF THE DIMENSIONED PARTS.
 12. DIMENSIONS ARE TO BE TAKEN TO THE CENTERLINE OF THE DIMENSIONED PARTS.
 13. DIMENSIONS ARE TO BE TAKEN TO THE CENTERLINE OF THE DIMENSIONED PARTS.
 14. DIMENSIONS ARE TO BE TAKEN TO THE CENTERLINE OF THE DIMENSIONED PARTS.
 15. DIMENSIONS ARE TO BE TAKEN TO THE CENTERLINE OF THE DIMENSIONED PARTS.
 16. DIMENSIONS ARE TO BE TAKEN TO THE CENTERLINE OF THE DIMENSIONED PARTS.

IND.	DATE	NOM/NAME	ZONE	MODIFICATION
16				
15				
14				
13				
12				
11				
10				
9				
8				
7				
6				
5				
4				
3				
2				
1				

DETAIL X
 ECHELLE 5:1

QUANT.	DESCRIPTION	POB	MT.	OBSERVATIONS	REF. COM.
	Lamination		Low C Steel		
	DIPOLE FOR MEDICAL MACHINE LAMINATION ECHELLE SCALE: 1:2 (5:1) REV/DRA: C, Rev1 1995-02-1 APPROV: CONTROL c:\MED\medma REPLACE/REPLACES				
NON VALABLE POUR EXECUTION					1
NOT VALID FOR EXECUTION					1

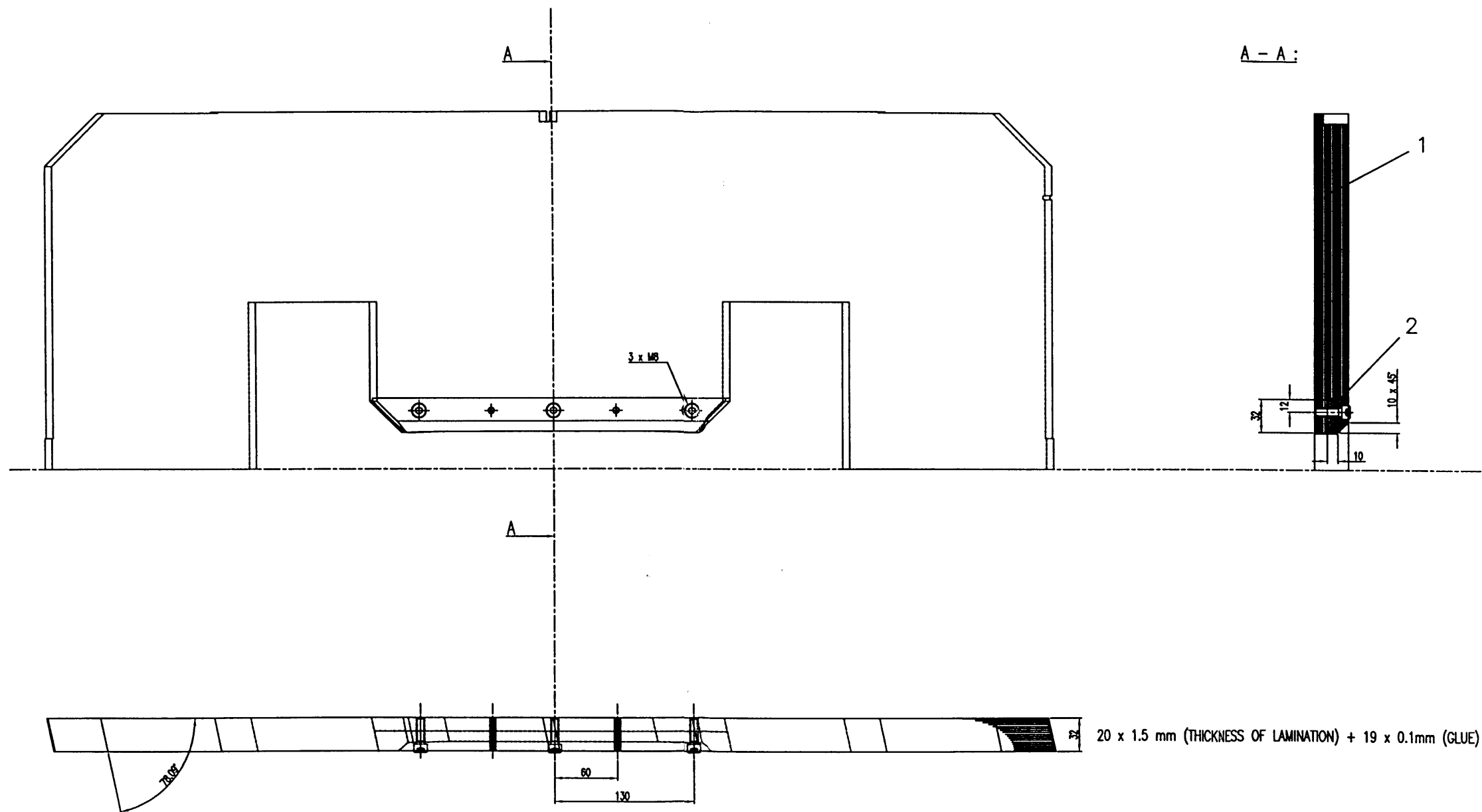
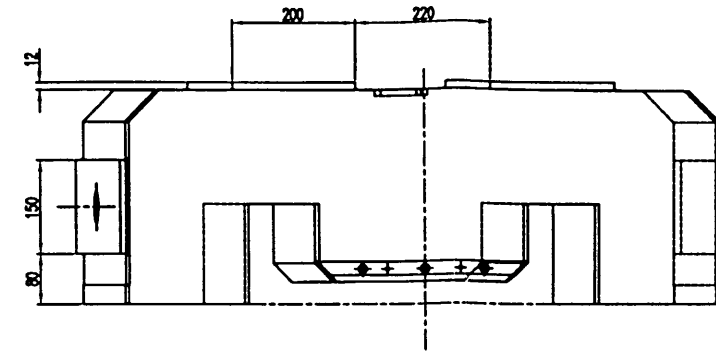
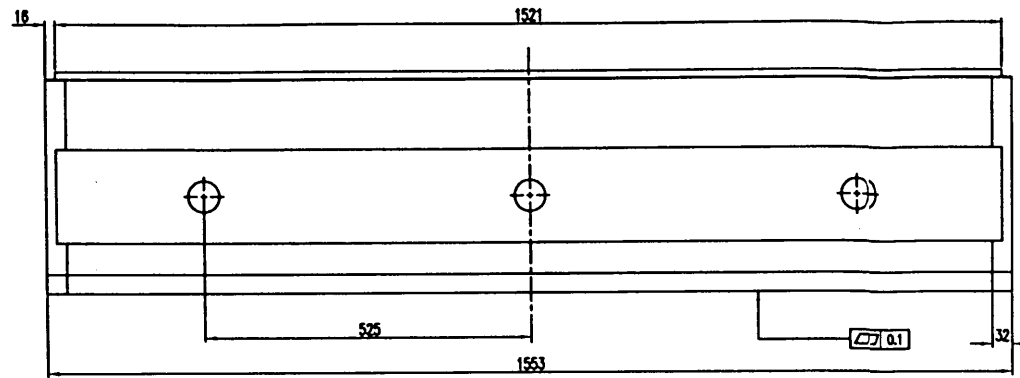

Fig. 3

CHECKING, REVISIONS, TO DIMENSIONS SHALL BE MADE BY THE DESIGNER AND THE MANUFACTURER SHALL BE RESPONSIBLE FOR THE ACCURACY OF THE DIMENSIONS.

IND.	DATE	NOM./NAME	ZONE	MODIFICATION
16				
15				
14				
13				

End Shim	2	Armo		
Lamination	1	Low C Steel		
DESCRIPTION	POS	MT.	OBSERVATIONS	REF.COM
DES/MS			S.DWG./LAMB	
DIPOLE FOR MEDICAL MACHINE GLUED END - STACK			SCALE	REV./NAME
			1:2	C. Blert
			CONTROL	1988-02-12
			APPROV.	
			C:\med\medmo_3	
			REPLACE/REPLACES	
NON VALABLE POUR EXECUTION				1
NOT VALID FOR EXECUTION				



ALL WELDS ± 2
 TOLERANCES FOR STRAIGHTNESS OF THE STACK ± 0.1 mm

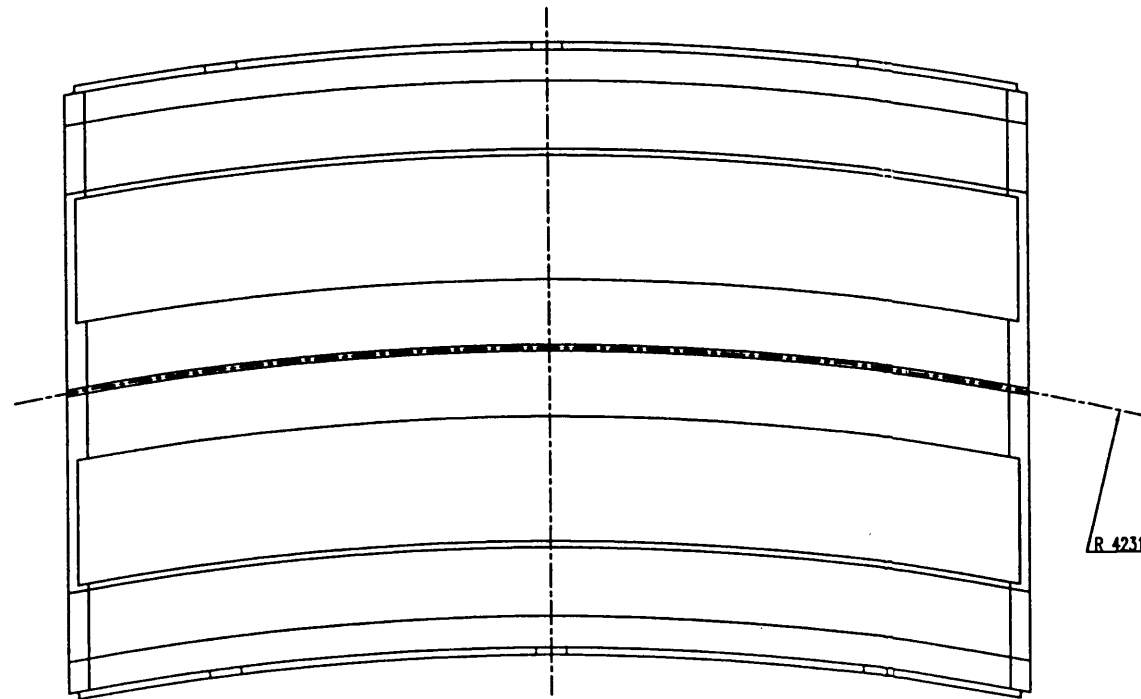

REVISIONS
 1. DIMENSIONS ARE IN MILLIMETERS
 2. DIMENSIONS ARE TO UNLESS OTHERWISE SPECIFIED
 3. DIMENSIONS ARE TO UNLESS OTHERWISE SPECIFIED
 4. DIMENSIONS ARE TO UNLESS OTHERWISE SPECIFIED
 5. DIMENSIONS ARE TO UNLESS OTHERWISE SPECIFIED
 6. DIMENSIONS ARE TO UNLESS OTHERWISE SPECIFIED
 7. DIMENSIONS ARE TO UNLESS OTHERWISE SPECIFIED
 8. DIMENSIONS ARE TO UNLESS OTHERWISE SPECIFIED
 9. DIMENSIONS ARE TO UNLESS OTHERWISE SPECIFIED
 10. DIMENSIONS ARE TO UNLESS OTHERWISE SPECIFIED
 11. DIMENSIONS ARE TO UNLESS OTHERWISE SPECIFIED
 12. DIMENSIONS ARE TO UNLESS OTHERWISE SPECIFIED
 13. DIMENSIONS ARE TO UNLESS OTHERWISE SPECIFIED
 14. DIMENSIONS ARE TO UNLESS OTHERWISE SPECIFIED
 15. DIMENSIONS ARE TO UNLESS OTHERWISE SPECIFIED
 16. DIMENSIONS ARE TO UNLESS OTHERWISE SPECIFIED

IND.	DATE	NOV/NAME	ZONE	MODIFICATION
16				
15				
14				
13				
12				
11				
10				
9				
8				
7				
6				
5				
4				
3				
2				
1				

Fig. 4

DESCRIPTION	FOR	MTL	OPERATIONS	REF. COM.
DIPOLE FOR MEDICAL MACHINE STACK				
SCALE	1:5			
DESIGNER	C. Bieri			1988-02-13
CONTROL				
APPROV.	J. MED medma			4
REPLACE/REPLACES				

NON VALIDE POUR EXECUTION
 NOT VALID FOR EXECUTION

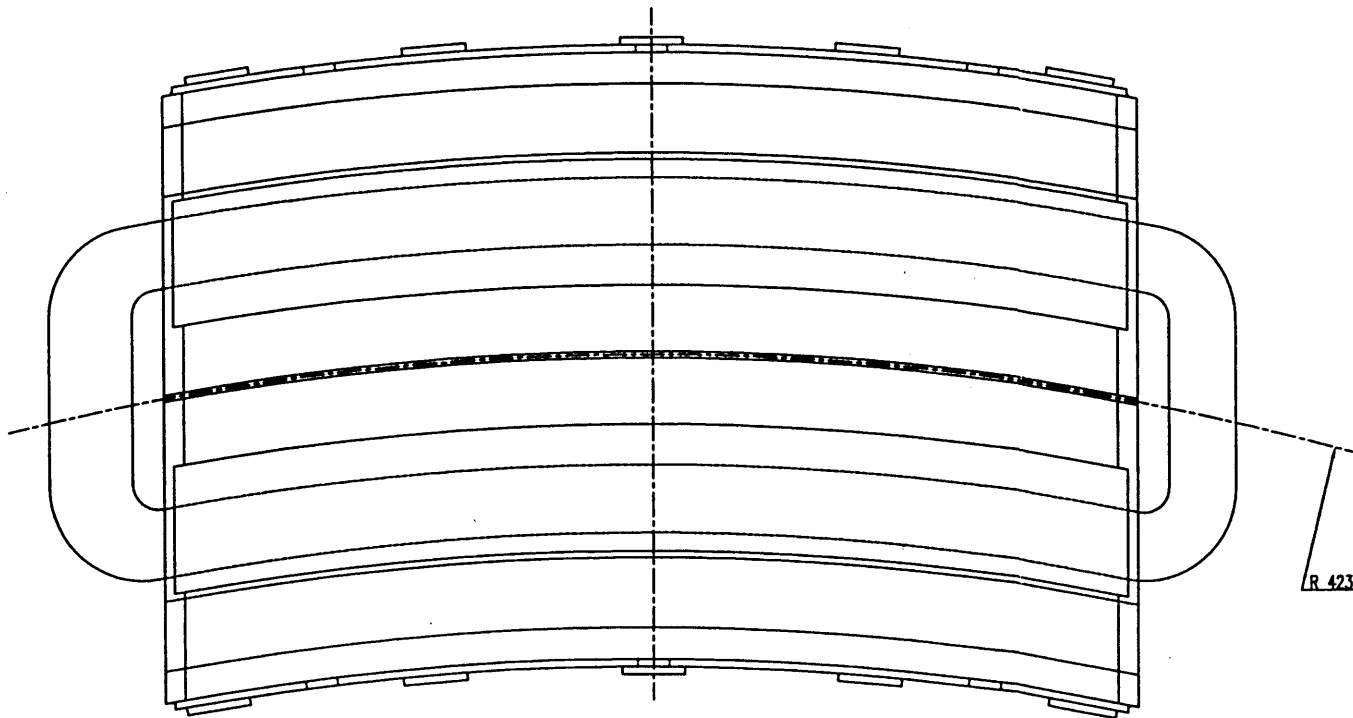
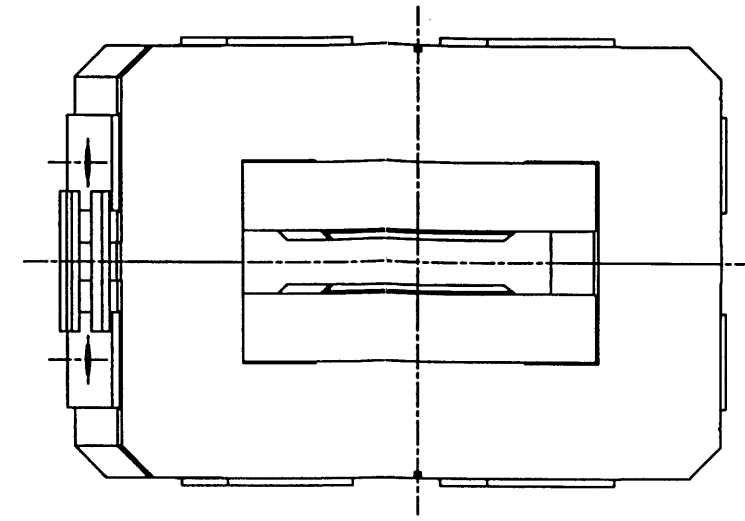
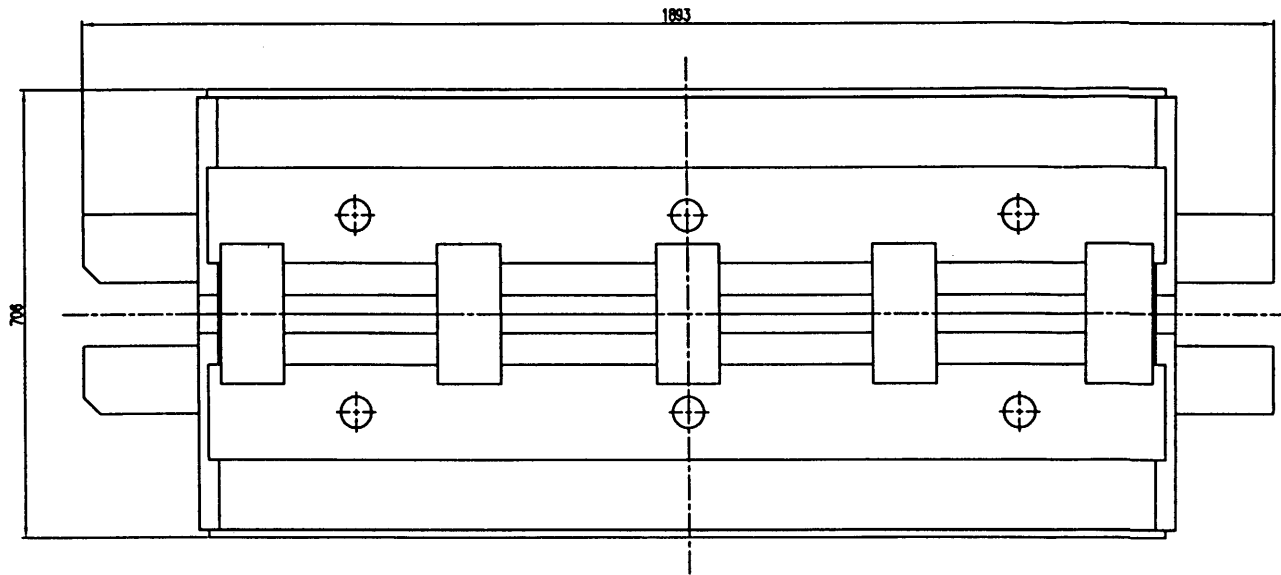

1. CHANGER
 2. CHANGER
 3. CHANGER
 4. CHANGER
 5. CHANGER
 6. CHANGER
 7. CHANGER
 8. CHANGER
 9. CHANGER
 10. CHANGER
 11. CHANGER
 12. CHANGER
 13. CHANGER
 14. CHANGER
 15. CHANGER
 16. CHANGER

1. CHANGER
 2. CHANGER
 3. CHANGER
 4. CHANGER
 5. CHANGER
 6. CHANGER
 7. CHANGER
 8. CHANGER
 9. CHANGER
 10. CHANGER
 11. CHANGER
 12. CHANGER
 13. CHANGER
 14. CHANGER
 15. CHANGER
 16. CHANGER

1. CHANGER
 2. CHANGER
 3. CHANGER
 4. CHANGER
 5. CHANGER
 6. CHANGER
 7. CHANGER
 8. CHANGER
 9. CHANGER
 10. CHANGER
 11. CHANGER
 12. CHANGER
 13. CHANGER
 14. CHANGER
 15. CHANGER
 16. CHANGER

Fig. 5

CHANG.	DESCRIPTION	POS.	INT.	OBSERVATIONS	REF. DESIG.
1					
2					
3					
4					
5					
6					
7					
8					
9					
10					
11					
12					
13					
14					
15					
16					

DIPOLE FOR MEDICAL MACHINE ASSEMBLY		ECHELLE SCALE 1:5	NOM/NAME C. Bert	DATE 1998-02-13
CONTROL C:\med\medma_5		APPR. REMPLACER/REPLACER		

NON VALABLE POUR EXECUTION
 NOT VALID FOR EXECUTION

IND.	DATE	NOM/NAME	ZONE	MODIFICATION
16				
15				
14				
13				
12				
11				
10				
9				
8				
7				
6				
5				
4				
3				
2				
1				

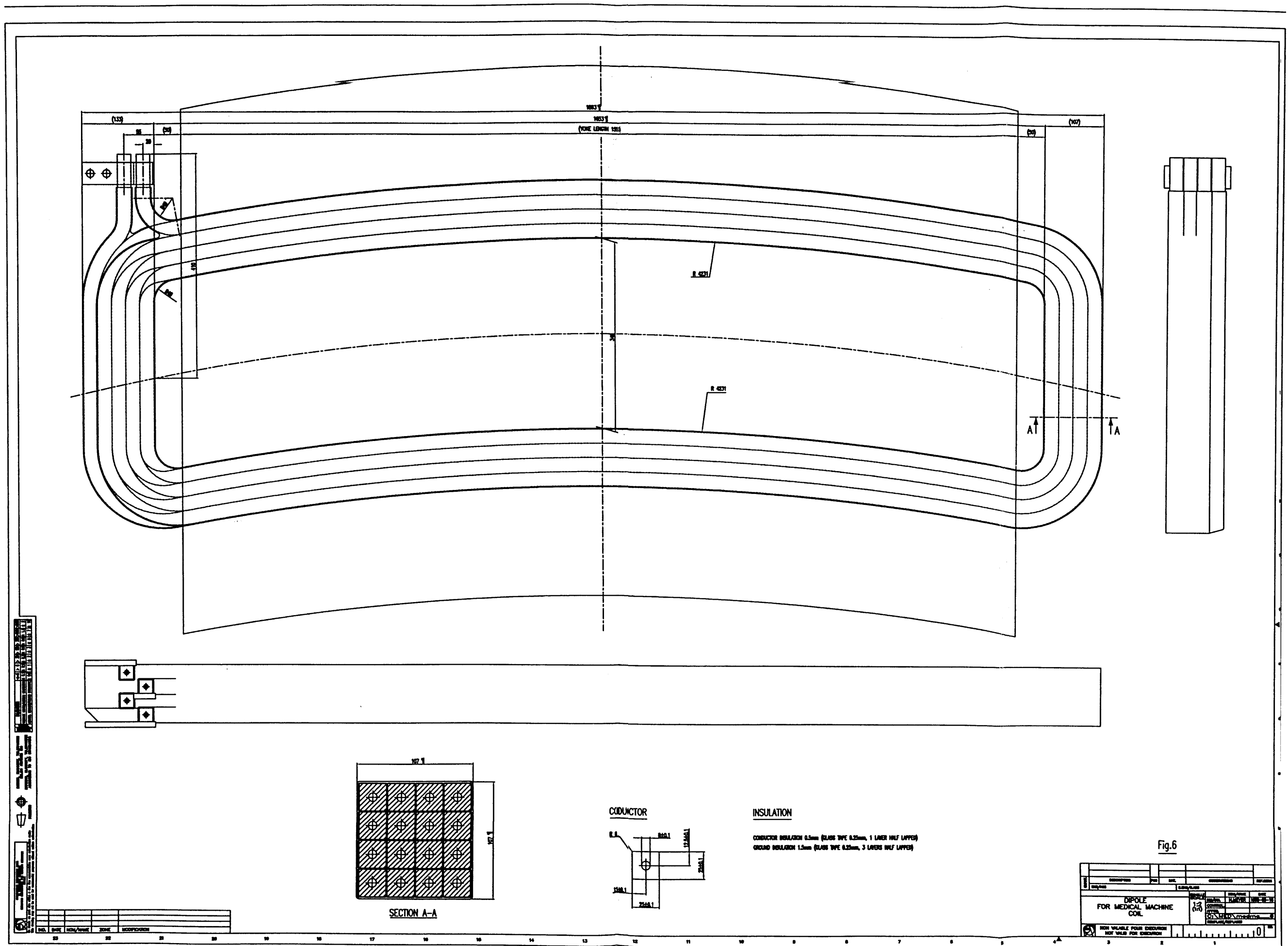

1. THE DRAWING IS THE PROPERTY OF THE COMPANY AND IS NOT TO BE REPRODUCED OR TRANSMITTED IN ANY FORM OR BY ANY MEANS, ELECTRONIC OR MECHANICAL, INCLUDING PHOTOCOPYING, RECORDING, OR BY ANY INFORMATION STORAGE AND RETRIEVAL SYSTEM, WITHOUT THE WRITTEN PERMISSION OF THE COMPANY.
 2. THE COMPANY ACCEPTS NO LIABILITY FOR ANY DAMAGE OR LOSS OF PROFITS, BUSINESS, OR REPUTATION, OR FOR ANY SPECIAL, INCIDENTAL, OR CONSEQUENTIAL DAMAGES, WHETHER IN A CONTRACT OR OTHERWISE, ARISING OUT OF OR FROM THE USE OF THIS DRAWING.
 3. THE COMPANY SHALL NOT BE RESPONSIBLE FOR ANY ERRORS OR OMISSIONS IN THIS DRAWING.
 4. THE COMPANY SHALL NOT BE RESPONSIBLE FOR ANY CHANGES IN THIS DRAWING WITHOUT THE WRITTEN PERMISSION OF THE COMPANY.
 5. THE COMPANY SHALL NOT BE RESPONSIBLE FOR ANY DELAYS OR INTERRUPTIONS IN THE DELIVERY OF THIS DRAWING.
 6. THE COMPANY SHALL NOT BE RESPONSIBLE FOR ANY COSTS OF REPRODUCTION OR TRANSMISSION OF THIS DRAWING.
 7. THE COMPANY SHALL NOT BE RESPONSIBLE FOR ANY DAMAGES OR LOSSES OF PROFITS, BUSINESS, OR REPUTATION, OR FOR ANY SPECIAL, INCIDENTAL, OR CONSEQUENTIAL DAMAGES, WHETHER IN A CONTRACT OR OTHERWISE, ARISING OUT OF OR FROM THE USE OF THIS DRAWING.
 8. THE COMPANY SHALL NOT BE RESPONSIBLE FOR ANY CHANGES IN THIS DRAWING WITHOUT THE WRITTEN PERMISSION OF THE COMPANY.
 9. THE COMPANY SHALL NOT BE RESPONSIBLE FOR ANY DELAYS OR INTERRUPTIONS IN THE DELIVERY OF THIS DRAWING.
 10. THE COMPANY SHALL NOT BE RESPONSIBLE FOR ANY COSTS OF REPRODUCTION OR TRANSMISSION OF THIS DRAWING.

NO.	DATE	REVISION	BY	DESCRIPTION

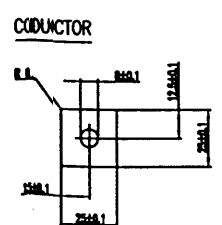
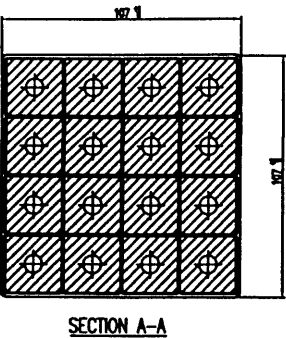

INSULATION
 CONDUCTOR INSULATION 0.5mm (GLASS TAPE 0.25mm, 1 LAYER HALF LAPPED)
 GROUND INSULATION 1.5mm (GLASS TAPE 0.25mm, 3 LAYERS HALF LAPPED)

Fig.6

NO.	DATE	REVISION	BY	DESCRIPTION

DIP-POLE
 FOR MEDICAL MACHINE
 COIL

1/20
 01/10/2020
 01/10/2020

NOT VALID FOR DESIGN
 NOT VALID FOR CONSTRUCTION

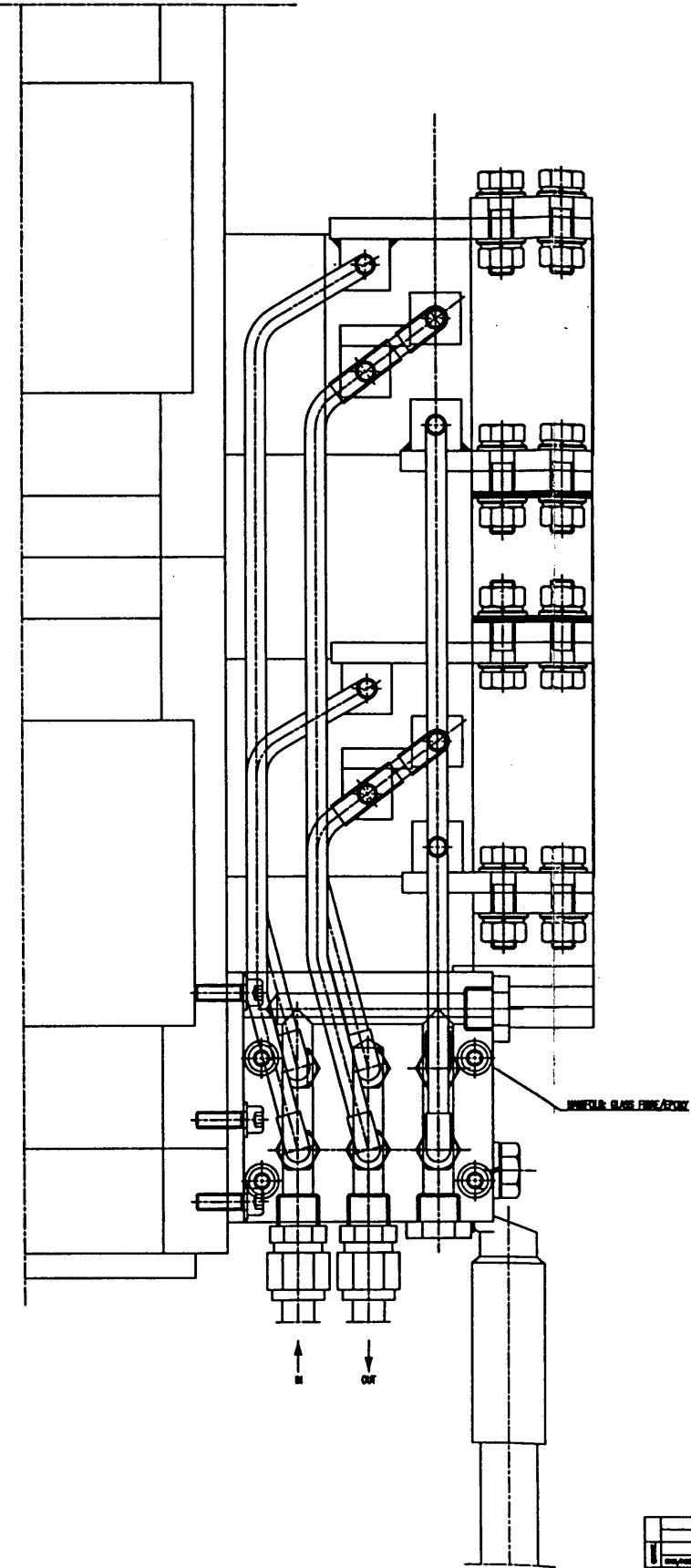
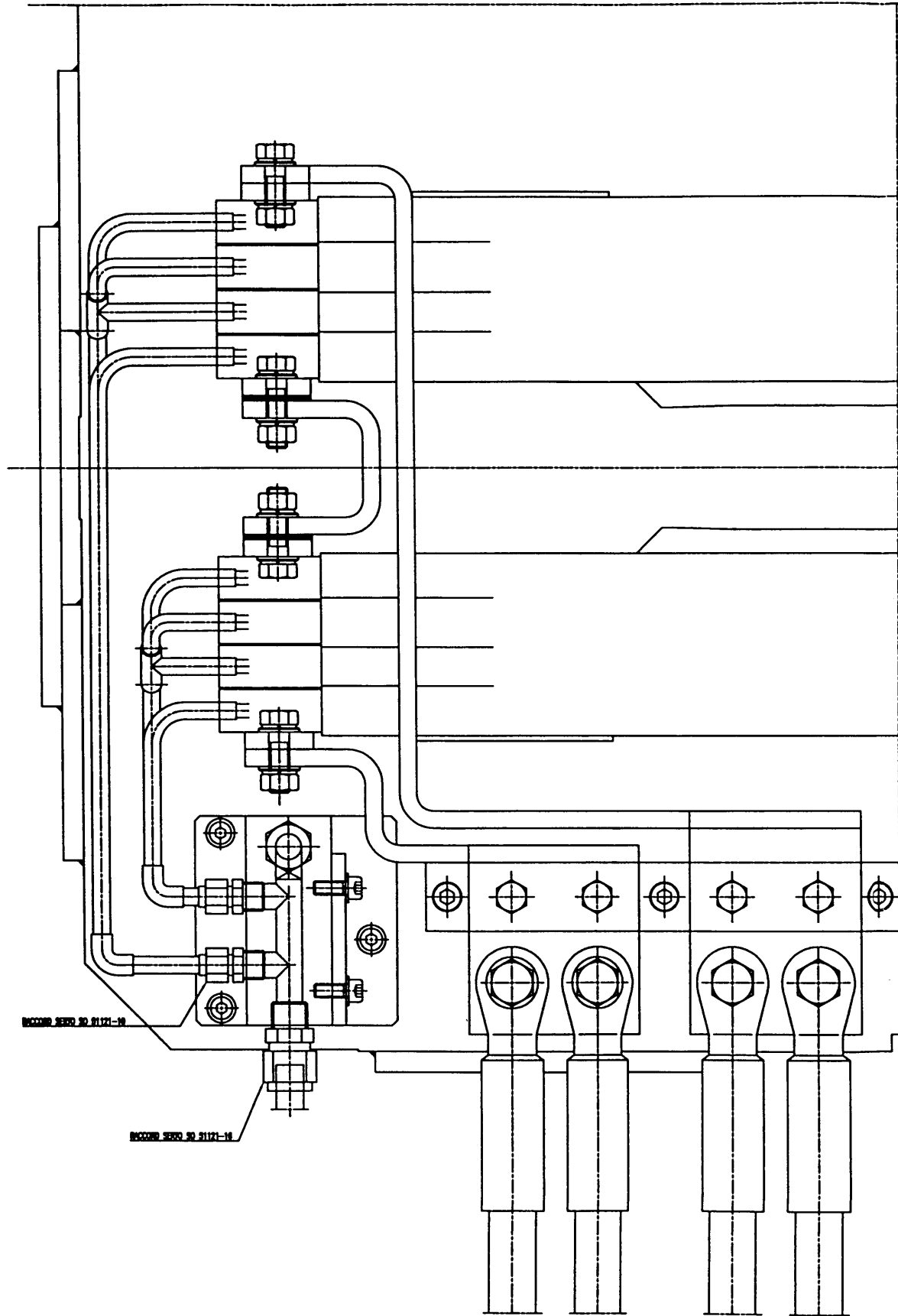

Fig.7

DESIGNER	CHK	APPROVED	DATE
DATE	REV	DESCRIPTION	BY
DIPOLE FOR MEDICAL MACHINE COIL ASSEMBLY			
SCALE		1:1	DATE
DRAWN		DATE	1968-08-28
CHECKED		DATE	
APPROVED		DATE	
NON FLAMMABLE FOR DISCHARGE SEE WALK FOR DISCHARGE			

1	2	3	4	5	6	7	8	9	10	11	12	13	14	15	16	17	18	19	20	21	22	23	24	25	26	27	28	29	30
---	---	---	---	---	---	---	---	---	----	----	----	----	----	----	----	----	----	----	----	----	----	----	----	----	----	----	----	----	----