

# AN LHC PROTECTION SYSTEM BASED ON FAST BEAM INTENSITY DROPS

M. Gasior, T. Levens, CERN, Geneva, Switzerland

## Abstract

The Large Hadron Collider (LHC) is protected against potentially dangerous beam losses by a distributed system based on some four thousand beam loss monitors. To provide an additional level of safety, the LHC has been equipped with a system to detect fast beam intensity drops and trigger a beam dump for potentially dangerous rates. This paper describes the architecture of the system and its signal processing, optimized to cope with dump thresholds in the order of 0.01% of the circulating beam intensity. The performance of the installed system is presented based upon beam measurements.

## INTRODUCTION

The LHC Beam Charge Change Monitor (BCCM), also called the  $dI/dt$  system, is specified to trigger beam dumps for beam losses exceeding thresholds in six integration windows in two beam energy ranges, as summarised in Table 1. The integration window lengths, expressed in units of the LHC revolution period  $T_r$  ( $\approx 89 \mu\text{s}$ ), have been chosen to correspond to integration periods of the Beam Loss Monitoring (BLM) system. The BCCM is required to operate for beam intensities from  $5 \times 10^9$  elementary charges ( $q_0$ ) for a single pilot bunch, up to  $6 \times 10^{14} q_0$  for  $\approx 2800$  physics beam bunches of  $2.1 \times 10^{11} q_0$ , resulting in the intensity dynamic range of  $\approx 10^5$  and the beam signal dynamic range of  $\approx 40$ . Thus, the smallest beam dump threshold of  $0.5 \times 10^{11} q_0$  for the longest integration window in the high energy range corresponds to an intensity change of  $\approx 0.008\%$ . Such challenging beam dump threshold levels and the required operational reliability have proved to be very difficult to satisfy at the same time. The BCCM system design described in this paper was preceded by a few prototypes and the experience gained at each stage contributed to the improving performance.

The initial prototype of the system was based on signals from Fast Beam Current Transformers (FBCTs), with 16-bit ADCs sampling at 160 MHz and IQ narrowband processing of the 40 MHz beam component implemented in an FPGA [1]. A mayor limitation of the first prototype was the beam sensor itself, as its readings were beam position dependent [1]. This triggered a development of a new technology, resulting in Wall Current Transformers (WCTs) [2], which removed the beam position dependence problem [3] and finally replaced the FBCTs. Then the WCT signals were used in the next version of the BCCM and the signal processing was updated. However, this version had not achieved the required reliability to work as an LHC protection system without triggering false dumps. Finally, the architecture of the BCCM was revised and the system was completely rebuilt according to the design described in this paper.

Table 1: BCCM Beam Dump Threshold Levels in  $10^{11} q_0$

Beam energy	Integration window lengths in $T_r$ units					
	1	4	16	64	225	1125
$< 0.5 \text{ TeV}$	6	6	6	6	6	6
$\geq 0.5 \text{ TeV}$	3	3	3	3	2	0.5

The most fundamental change in the new BCCM is the source of the beam signal, where the WCT has been replaced by the sum signal of a beam position monitor (BPM). This way the development of the BCCM became independent of the beam intensity measurement system, which is critical for the LHC operation and therefore any changes to its parameters were very difficult. This was previously posing serious limitations during the development of the BCCM. The BPM also provides larger signals than the WCM, which contributes to the improved noise performance of the present system.

The signal processing now used in the BCCM provides a few improvements and simplifications:

- the fast beam signals are rectified, allowing the system bandwidth to be strongly limited by low-pass filters already before the ADC;
- in consequence, the beam synchronous ADC sampling could be lowered to 40 MHz, allowing to use high signal-to-noise ratio ADCs and facilitating the digital signal processing;
- the idea of one revolution digital delay line was introduced: the beam signal changes are calculated as plain differences of one revolution period integrals, allowing simple, reliable and efficient signal processing;
- the ADC sampling phase does not need to be adjusted to the beam signal, increasing the simplicity and robustness of the system operation.

The new LHC BCCM system based on the mentioned features is described in the following sections and its performance illustrated with beam measurements.

## SYSTEM ARCHITECTURE

The block diagram of the BCCM is shown in Fig. 1, along with signals sketched in key nodes of the system. The signals from four electrodes of a BPM are first processed by 80 MHz non-reflecting low-pass filters (NRLP), amplified by RF amplifiers (RFA) and then combined to remove their beam position dependence. The resultant signal is rectified by an envelope detector (ED), which allows subsequent strong low-pass filtering, essential to limit the system bandwidth and in consequence noise. The filtered signal is digitised by a 16-bit ADC (LTC2204) sampling at 40 MHz derived from the 400 MHz LHC RF frequency. The ADC samples are processed by an FPGA

Content from this work may be used under the terms of the CC BY 4.0 licence (© 2022). Any distribution of this work must maintain attribution to the author(s), title of the work, publisher, and DOI

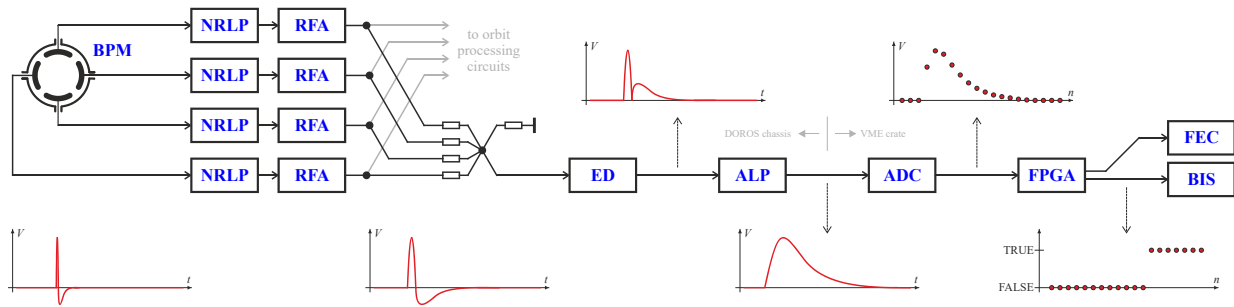

Figure 1: Block diagram of the BCCM system. BPM – Beam Position Monitor, NRLP – Non-Reflecting RF Low Pass filter, RFA – RF Amplifier, ED – Envelope Detector, ALP – Active Low Pass filter, FEC – Front-End Computer.

(ARRIA V), which generates the beam dump triggers to the LHC Beam Interlock System (BIS).

The BCCM triggers a beam dump when a beam intensity change rate in one of the six integration windows is above the corresponding dump threshold level. A beam dump is also requested upon certain system error conditions, such as the lack of the 400 MHz RF signal or a sample reaching the ADC full scale limit.

To implement energy dependent thresholds, the BCCM also receives the beam energy information from the LHC timing system. In case this information is missing, the beams will not be dumped but instead the system operates with the worst-case settings, in the high energy range with the safer dump thresholds.

A VME front-end computer (FEC) receives data from the FPGA every second and provides all functionalities, which are not time- nor machine-safety critical, like system setup, operation monitoring and data logging. All FPGA signal processing is implemented as fixed-point integer arithmetic, so the FEC also provides all translation between intensities measured in charges and the integer equivalents.

Each of the LHC beams is equipped with two redundant BCCM systems which must be operational at all times. If any system detects an abnormal beam intensity change, dump triggers are issued within microseconds for both beams. The four BCCM systems consists of two 1U 19" chassis accommodating the analog processing, two 3U VME crates hosting the FPGA boards, the ADC mezzanines and interface to the BIS. A part of the analog processing, marked on the system block diagram in Fig. 1, is shared with the DOROS system [4]. The system provides amplitudes of beam signals on each electrode of the system BPMs, along with their beam position readings used for BCCM operation monitoring.

## SIGNAL PROCESSING

The key part of the BCCM analog signal processing is the beam signal rectification, realised with an RF envelope detector ADL5511. This allows the bandwidth of the rectified signals to be well limited by the following active low pass filters. The strong filtering causes the beam pulses to overlap as it will be shown in the next section, however, low-pass filtering conserves the signal integrals, so even the acquired signals have quite different forms than the beam signals, their integrals are maintained.

The beam synchronous sampling of the ADC allows the FPGA to synchronise to the LHC revolution period by working on sets of 3564 ADC samples. Then the one revolution period ( $1T_r$ ) integrals are calculated as simple sums of samples with the amplitudes above a threshold, which prevents integrating the noise from the samples with no beam signal. The Simpson integration method was also tried with the hope for smaller integration noise, but no advantage was observed over the simplest rectangle method.

The  $1T_r$  intensity change is just a difference of  $1T_r$  integrals from two consecutive turns and the intensity changes for the other five integration windows are similarly calculated. The intensity changes in the six windows are compared every revolution period to the corresponding beam dump thresholds.

The dump thresholds are expressed in absolute beam intensity losses, so the system needs to know the actual intensity of the circulating beam. To avoid dependences upon other systems, the intensity is obtained locally by scaling the beam signal integrals evaluated by the BCCM to correspond to the intensity readings of the LHC BCTs.

## BEAM MEASUREMENT EXAMPLES

The effect of the heavy low-pass filtering of the beam signal is shown in Fig. 2, presenting an example of the normalised raw ADC samples for one revolution period with the LHC fully filled. The fact that the beam pulses spaced by 25 ns overlap is documented in Fig. 3, showing with finer time resolution a  $2 \mu\text{s}$  segment of Fig. 2. The system can efficiently operate with such slow signals, since the overlap is identical in consecutive revolution periods, so are the revolution integrals, resulting in zero difference when the beam intensity is constant. It can be seen that the risetime of the signal is about six 25 ns sampling periods, which corresponds to the system bandwidth of about 2 MHz. The long signal tail seen between the bunch trains is a feature of the envelope detector chip used, but again, due to the chosen digital signal processing, this defect has no importance for the proper operation of the system.

Typical BCCM operation during a short full LHC beam cycle is illustrated in Fig. 4, showing the beam intensity and its maximal drops in the three shortest integration windows for which the system operates well. The BCCM properly detects injection losses, which go up to some 30%

of the dump threshold for the  $4T_r$  integration window and about 40% of the system maximal beam intensity. With higher intensities the injection losses could increase, so the specification of the system must be revised to assure at the same time a safe operation of the LHC and prevent the BCCM system from triggering unnecessary dumps.

The relative accuracy of the intensity readings provided by both redundant BCCMs of LHC beam 1 (B1) as compared to a Fast BCT and a DC BCT is presented in Fig. 5, showing the corresponding normalised intensities at the beginning and at the end of a 13.5 h beam cycle. It is seen that the BCCMs follow the BCTs through the energy ramp within  $\approx 0.5\%$ . Small ripples seen in the BCCM readings are caused by bunch length fluctuations related to a longitudinal emittance blow-up (LEBU) [5] used to prevent the bunch length shortening over the beam acceleration. During the next 13 h of the beam cycle at 6.8 TeV the bunch length shrinks from  $\approx 1.2$  ns to  $\approx 0.8$  ns, causing the BCCM readings, originating from BPMs which are high-pass systems, to be larger than the BCT readings by around 3%. Such errors are completely acceptable, especially since the BCCM readings are overestimated and so the dump triggers will be then issued for smaller loss rates than specified.

Intensity drop examples for the two longest integration windows are presented in Fig. 6. For this particular cycle, the LEBU was accidentally only operational for beam 2 (B2), causing fast bunch length changes only for this beam. The changes were converted by the BPM to beam signal amplitude fluctuations, which were misinterpreted by the BCCM as intensity changes. The lack of the longitudinal blow-up for B1 caused a beam dump seen in Fig. 7, presenting revolution-by-revolution normalised intensities for both beams. Oscillations with amplitudes in the order of a few  $10^{-4}$ , related to the bunch synchrotron motion, are present only for B2 on both shown records, at the dump and 52 s earlier. The normalised intensities of B1 for which the LEBU was missing show only noise.

The unexpectedly large and fast bunch length changes caused by the LEBU limit the present performance of the BCCM system for the three longest integration windows, whose lengths are comparable to the beam synchrotron period. First tests have shown that the LEBU influence can be reduced by making the integration window lengths a multiple of the synchrotron period. However, as this period changes during the acceleration by a factor of two, such window lengths are a compromise and therefore can reduce the LEBU influence by only a few times. Other options of how to cope with the LEBU are under discussion. In short term the system could operate with a third energy range covering the period of LEBU activity, for which the dump thresholds could be raised. An ultimate solution would be to use a beam signal sensor with no bunch length dependence. The first obvious candidate is the BCT system based on WCTs, whose upgrades have been now finalised and therefore its signals should be easier to use than in the past. However, the WCT signals are lower than the BPM ones currently used and it must be carefully checked whether they are sufficient for a reliable BCCM operation.

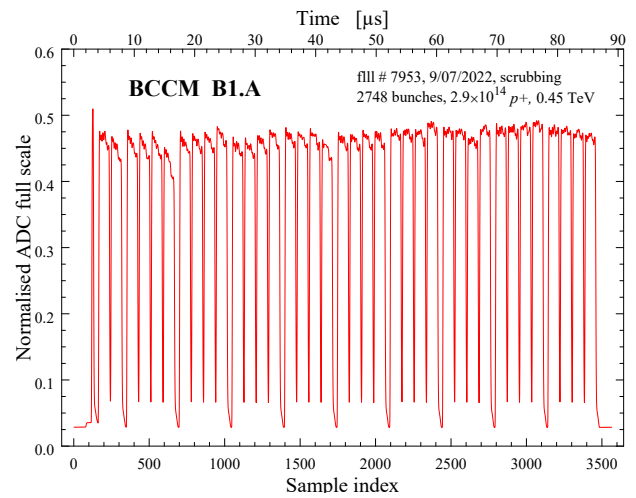

Figure 2: Normalised raw ADC samples over one revolution period with the LHC fully filled with protons ( $p^+$ ) during the 2022 scrubbing run.

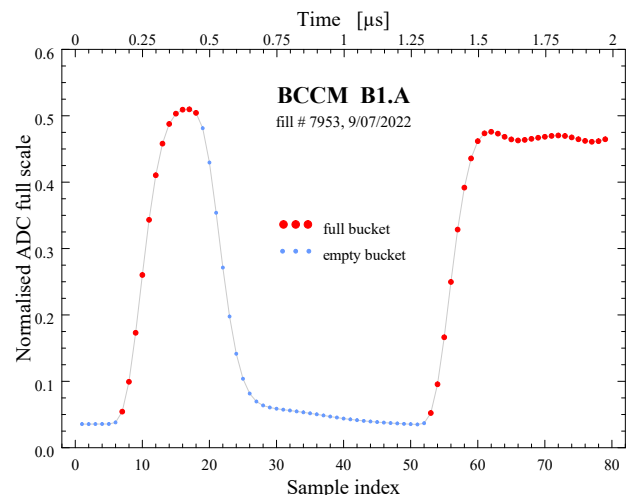

Figure 3: Zoom on a 2  $\mu$ s segment of the ADC samples shown in the above Fig. 2.

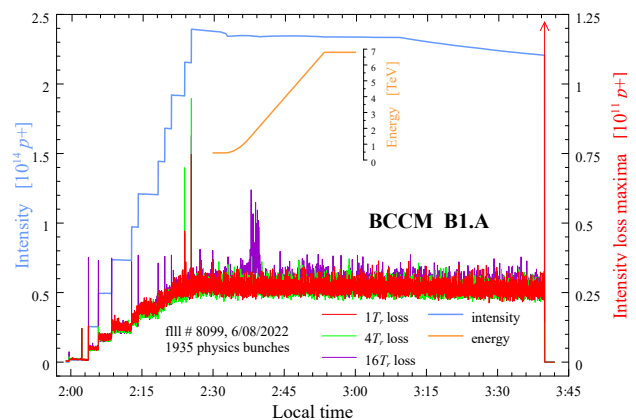

Figure 4: An example of BCCM signals during a full LHC beam cycle. Please note the 2000-fold difference in the scales for the left and right axes.

Content from this work may be used under the terms of the CC BY 4.0 licence (© 2022). Any distribution of this work must maintain attribution to the author(s), title of the work, publisher, and DOI

There was no observation of any dependence of BCCM readings on beam position changes in the used BPMs. The BPMs are not far from the RF cavities, so larger position changes should not be expected. This has been confirmed with measurements provided by the DOROS system using signals from the same BPMs.

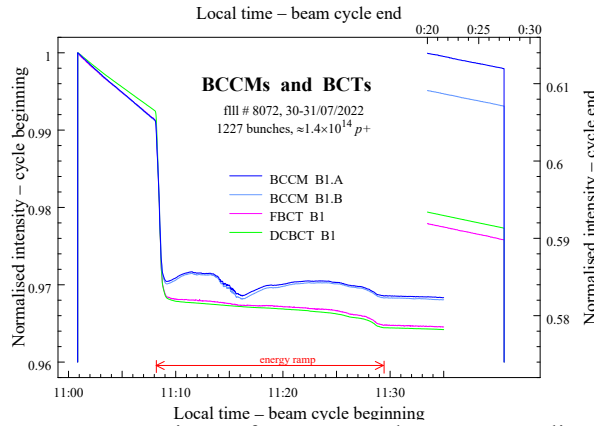

Figure 5: Comparison of BCCM and BCT normalised intensities at the beginning and the end of a beam cycle.

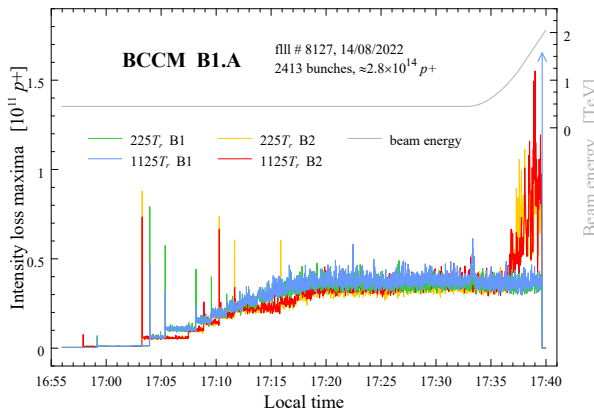

Figure 6: BCCM intensity losses in the two longest integration windows for B1 and B2 with the longitudinal emittance blow-up disabled and enabled, respectively.

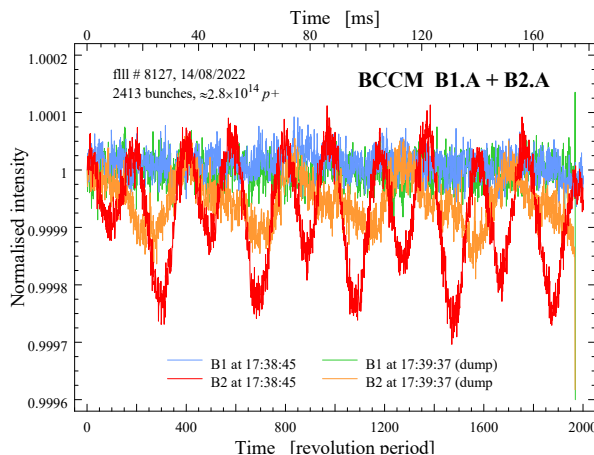

Figure 7: Normalised B1 and B2 intensities corresponding to the intensity losses shown in the above Fig. Note that the longitudinal emittance blow-up is present only for B2.

## SUMMARY AND OUTLOOK

The LHC BCCM system is based on beam signals from four sensors for both beams and is able to detect all beam losses, since it acts on the total beam intensity. Therefore, it very well complements the distributed LHC BLM system that make use of four thousand detectors and measures localised beam losses. The presented system, after many years of development, has finally achieved the required sensitivity and the reliability expected from a system from which a single 25 ns ADC sample can trigger a beam dump.

The 2022 LHC run is being used to optimise the BCCM before unmasking its dump triggers, planned for the LHC restart in 2023. To become a part of the LHC machine protection system, the BCCM must undergo an elaborate commissioning procedure with beam [6], so it is very important to minimise the probability that any system setting would need to be changed, as then the commissioning must have to be repeated.

The BCCM 2022 operation revealed some sensitivity to the longitudinal emittance blow-up for the three longest integration windows. This discovery is currently under discussion and corrections to the integration window lengths as well as to the dump threshold values are being evaluated.

## ACKNOWLEDGEMENTS

The authors are indebted to all members of the CERN Beam Instrumentation Group and the LHC Machine Protection Panel, who contributed to the long development of the BCCM, especially to Diogo Alves, David Belohrad, Michal Krupa, Jan Uythoven and Daniel Wollmann.

## REFERENCES

- [1] Belohrad, J. M. Belleman, L. K. Jensen, M. Krupa, and A. Topaloudis, “The LHC Fast Beam Current Change Monitor”, in *Proc. IBIC'13*, Oxford, UK, Sep. 2013, paper WEPF29, pp. 887-890.
- [2] M. Krupa and M. Gasior, “The Wall Current Transformer - a New Sensor for Precise Bunch-by-Bunch Intensity Measurements in the LHC”, in *Proc. IBIC'16*, Barcelona, Spain, Sep. 2016, pp. 568-571.  
doi:10.18429/JACoW-IBIC2016-WEAL02
- [3] M. Krupa *et al.*, “Summary of LHC MD 398: Verification of the dependence of the BCTF measurements on beam position and bunch length”, CERN-ACC-Note-2015-0031.
- [4] M. Gasior, G. Baud, J. Olexa, and G. Valentino, “First Operational Experience with the LHC Diode ORbit and OScillation (DOROS) System”, in *Proc. IBIC'16*, Barcelona, Spain, Sep. 2016, pp. 43-46.  
doi:10.18429/JACoW-IBIC2016-MOPG07
- [5] P. Baudrenghien *et al.*, “Longitudinal Emittance Blow-up in the LHC”, in *Proc. IPAC'11*, San Sebastian, Spain, Sep. 2011, paper TUPZ010, pp. 1819-1821.
- [6] M. Gasior, T. Levens, “MPS Commissioning Aspects of the Beam Charge Change Monitoring (BCCM) System”, LHC OP MPS 0021, EDMS 2683896.