

The CTF Run N° 4 - 1993 - Results and Comments

by H. Braun, JHB. Madsen and S. Schreiber

Participants : H. Braun, R. Bossart, J.P. Delahaye, K.K. Geissler, S. Hutchins,
J.C. Godot, I. Kamber, J.H.B. Madsen, G. Rossat, L. Rinolfi, A.J. Riche,
S. Schreiber, J. Sladen, G. Suberlucq, J.C. Thomi, I. Wilson,
W. Wuensch, F. Chautard

1. General

Start : 8th November
End : 17th December

Beamline : as used during the previous run (Fig. 1)

Gun : the same as well; no. 3b

Photocathode : Cu for the initial rf conditioning
: Cs₂Te for the e⁻ beam, constructed in G. Suberlucq's photocathode lab
: thickness of layers : Te 10 nm
Cs 16 nm
diameter 12 mm
QE in lab 3.2% at 266 nm

Photocathode transfer system used for the first time. (Fig. 2)

The system allows to make a cathode and to put it into the gun under vacuum.
Thanks to the system we could use Cs₂Te and change the laser wavelength to 262 nm.

Laser :

at 262 nm the laser was operated at an energy around $150 \cdot 10^{-6}$ J, pulse length
8 ps FWHH. Fig 3 gives the layout of the system as used.

Pulse train generator :

one laser pulse is split into a train of pulses spaced by one 3 GHz wavelength :
333.5 ps.

A train of 24 pulses was most effective for generating 30 GHz power by the
CLIC structure (see chapter 5).

Vacuum in chamber downstream of the gun : VGI04 $1.5 \cdot 10^{-9}$ T with rf.

The following new facilities eased the experimental work :

- the laser spot is monitored next to the entry window in the CTF and can be displayed on a TV in the HCR
- stepping currents in the steering magnets and acquiring beam charges done by soft
- remote control of the streakcamera and FWHH computation in the HCR

2. Objectives of the Run

- Test the photocathode transfer system
- Test the performances of Cs₂Te
- Study/compensate wakefields in LAS.
- Use a train of 24 laser pulses.
- Increase the 30 GHz power from TRS.

3. Gun

RF conditioning to 100 MV/m with the Cu cathode was completed in a couple of hours.

The first Cs₂Te cathode required about 25 hours of conditioning to reach 90 MV/m. With the second cathode 100 MV/m were obtained within 3 hrs.

Usually, after a cathode exchange, the tune is measured and if needed adjusted. For the measurement the waveguide has to be broken and the job takes about half a day. As the cathode plugs should be identical we did no tune check after the last cathode change. It turned out OK.

One cathode plug could not be fully inserted into the gun. Some of the rf spring contacts were bent. We still investigate the cause of this incident.

4. The Cs₂Te Photocathode

The first cathode was made on 2nd Nov. QE measured in the dc-gun: 3.2 %. Insertion in the rf gun on 10th Nov. After the long rf conditioning the max. QE estimated during the first days is 1.6 %. (p. 152 of log).

The cathode produced a beam during 13 working days and QE had dropped to roughly 0.5 %. The cathode is robust, it did not suffer from receiving the full laser energy approx. 150 10⁻⁶ J. The cathode was exchanged on 8th Dec. Initial QE of second cathode 3.6 %. After 7 days the QE was still between 1 and 1.5 %. The QE's quoted are found with low charges (see below, ch. 6.1).

5. The Laser and the Pulse train Generator

At 262 nm the laser energy is no longer a limiting factor for the beam experiments.

In general, the laser was running smoothly. It was operated below its nominal energy at 70% of the maximal flash lamp voltage for the amplifiers.

The spatial beam profile was better than in previous runs (at 209 nm) but still not satisfactory.

A problem appeared : the position of the laser pulse on the cathode has a larger jitter than during previous runs. This jitter could be reduced by turning off the air conditioning, by shielding the laser beam against the heat produced by the flash lamp of the main amplifier and by enclosing as much as possible laser components on the bench.

Further and more permanent improvements will have to be made. The laser pulse train generator PTG was divided into two parts: one unit to split 1 pulse into 8 pulses (Fig. 4) and a second one, added later, to split the 8 pulses into a train of 16 pulses spaced by 333 ps.

By amplifying two consecutive pulses from the LEC mode locked laser - pulses spaced by 4 ns - and by dumping the last 4 pulses of the 16, the PTG delivered a continuous train of 2 times 12 pulses. The splitters used in the PTG are operating at a small angle (5°).

This has the advantage that the splitting ratio of 51:49 is independent of the polarization. On the other hand, the split beams are separated in space. Each of the split pulses has a reflector to steer the pulse onto the cathode. This turned out to be very valuable as it allows with fine steering to reduce the effects of the wakefields in the accelerating section.

The time between the pulses was set using comparators with 10 μ m resolution. The settings were checked by phase measurements on each e⁻ bunch and then corrected if required.

The splitting ratio of 51 : 49 favours the pulses split last yielding a more uniform energy distribution from pulse to pulse. The charge from bunch to bunch varies within 10%.

6. Beam Characteristics

6.1 Charge behind the gun as function of the laser energy and spot size

The charge is measured with the UMA385 at .75 m downstream of the cathode. This charge depends on the 'laser phase, LPh' LPh. : time the centre of the laser pulse hits the pc minus the time the field is zero in the gun (values quoted are relative only). Example : fig. 5

With the CsI cathodes we had found that the charge from the gun saturates if the laser energy on the cathodes is increased. Cs₂Te behaves rather similar (Fig. 6). On this figure we see as well the effect of the QE and the spot size (larger spot gives more charge).

All measurements are done with single bunches. Beam simulations made by H. Braun show that the extractable charge is limited by two effects : e⁻ field cancellation on the pc if the laser spot is small and by aperture restrictions if the spot is large. Results with the simulations agree rather well with the 'saturation' observed. In the simulations it is assumed that the photocathode emits a charge proportional to the energy received (QE constant).

This may not be correct and the observation reported below in ch. 6.2 indicates that saturation may occur in the cathode as well.

Is the response of the UMA linear? The UMA had been compared with a Faraday Cup. For 6.7 nC on the UMA the FC gave 6.9 nC (p. 89 of log.) No comparisons were made for higher charges. For a train of 8 bunches with 1.9 nC pb, the agreement UMA/FC is within 10 % (p. 101).

6.2 Loss in QE of the Cathode if a Laser Pulse Train is used

Assume that the 1st laser pulse alone gives a charge X at UMA385.

Second laser pulse alone : charge Y.

First + second laser pulse : charge Z.

Finding that Z is smaller than X+Y except for charges below 1 nC.

The percentage the second bunch charge contributes to the first and second pulse together is : $(Z - X) / Y \times 100\%$

The contribution of each bunch in a train of 8 bunches is shown for two different charges on fig. 7. We notice that the contribution drops if the charge increases.

The loss in QE over the train depends as well on the time between the bunches. Illustrated on fig. 8. The 4 bunch train with double spacing has as much charge as the 8 bunch train. By increasing the spacing even more we see that bunch 1 + 8 adds up fully. It looks like that after the cathode is hit by a laser pulse its QE drops and returns 'slowly' to its initial value. Similar to the effects reported for GaAs ?

The question is are above observations caused by 'instrumental' effects? As said before, we compared during a previous run the UMA with a FC and for a 8 bunch train of 1.9 nC per bunch the readings agreed within 10%. Thus, it is not very likely that the observed drop in contribution for charges below 2 nC is 'instrumental'. However, this has to be proven during the next run.

6.3 Beam Transmission

Reminder. UMA385 for charge behind the gun

UMA406 for charge behind the accelerating section, LAS

UMA455 for charge behind the CLIC structure, TRS

The single bunch transmission through TRS could be improved by using the solenoid SNL400 on LAS. The transverse bunch distortion due to wakefields effects in LAS is to a certain extend corrected by the solenoid field. Fig. 9: 7.1 nC passes TRS with practically no loss. If the gun charge increases the wakefield correction becomes less effective and the transmission drops. See fig 9 : 10.4 nC from gun and 7.5 nC behind TRS.

The 8 bunch train case. To transmit a high total charge through TRS one has to limit the charge per bunch as otherwise the wakefields are distorting too much the train. The train on fig. 10 gave a maximum of 30 GHz (14 MW peak).

Getting good transmission becomes even more difficult with a train of twice 8 bunches with 4 missing bunches in between (Fig. 10).

The continuous train of 24 bunches shown on Fig. 11 generated the highest 30 GHz power. The total charge from the gun is the same as the 2 x 8 bunch case but the transmission is better (72 %) as the charge per bunch is lower.

6.4 Bunch Length

The detector - TCM445T - sits in front of TRS. The results with the streak camera have for a given setting a spread of ± 2 ps, FWHH. Varying the laser energy on the cathode from 1 to 55 10^{-6} J did not change much the length : 10 to 14 ps. See p. 170. The bunch length of the individual bunches in the 2 x 8 train were measured . Average length : 13 ps ; max.16.2 ps and min.9.0 ps. P.225/226

6.5 Bunch Transverse Profile

Measured with TCM445T.

On Fig. 12 : profile of a single bunch, charge 4 nC, after optimization with the steering DHZ400 on LAS. (SNL400 at 200 A), p. 190 Next, the beam spot was made more circular with QDN420 : x & y about 2.mm FWHH.

The observation of profiles of the bunches in the train is indispensable for minimizing the wakefields effect by varying the laser pulse position on the cathode and by beam steering.

Fig. 13 : 8 bunches generating 14 MW 30 GHz peak, p. 220. On the same figure we see 18 bunches of the 24 b-train and with another time scale the start and the end of the train. The bunch position is fluctuating most at the end of the train, p. 231 and 236.

7. The 30 GHz Power Measurements Compared with Calculated Values Using Measured Charges and Bunch Length

It needs some courage to digest the data on Table 1 but it will disturb the quiet mind of the patient reader. For the measured power the calibration curves provided by JPH. Sladen and W. Wuensch are used (memo, 4/11/93, SL-RFL/JPHS; 40 dB curves).

The power from the section is according to I. Wilson:

$$P = 29.2 (q \text{ in nC}) * 2 \text{ kW}$$

$$q = \text{effective charge} = F.Q$$

$$F = \text{spectral factor}$$

$$Q = \text{total charge}$$

For a triangular charge distribution with a FWHH = 14 ps , $F = 0.539$

In the single bunch case the measured and calculated power compare rather well. (see the values for F to get a correspondence) The comparison breaks down in the 8 bunch train case. Even if assuming that the charge at UMA406 fully contributes to the power generation. Measured and calculated power differ less in the two times 8 bunch and the 24 bunch case if the contributing charge is in between UMA406 and 455 and if F is close to 1.

The measurement of the field created by TRS in CAS with the probe beam gave 55 MV/m. The measured peak power from TRS : 33 MW....expected field in CAS : 59 MV/m, p. 232

The reacceleration is measured with BHZ700, a magnet identical to BHZ430. There is a calibration problem as the beam momentum with BHZ430 gave 55 MeV/c and with BHZ500 63.4 MeV/c. Thus E-cas is higher than 55 MV/m. The probe beam measurement is in rather a good agreement with the field derived from the power from the TRS.

Thus, what is wrong with the calculated power? At first we have to check the charge measurement with the UMA's. Secondly we want an average power reading to relate it to the average charge readings. However, do we overlook other factors?

CTF BEAMLINE OCT. '93

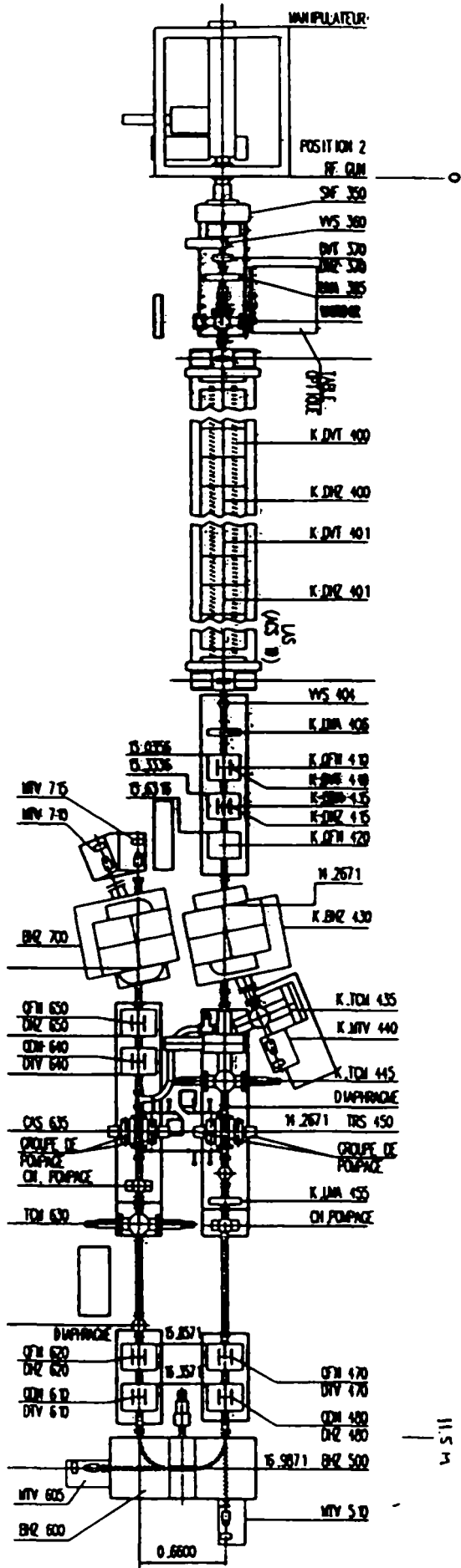
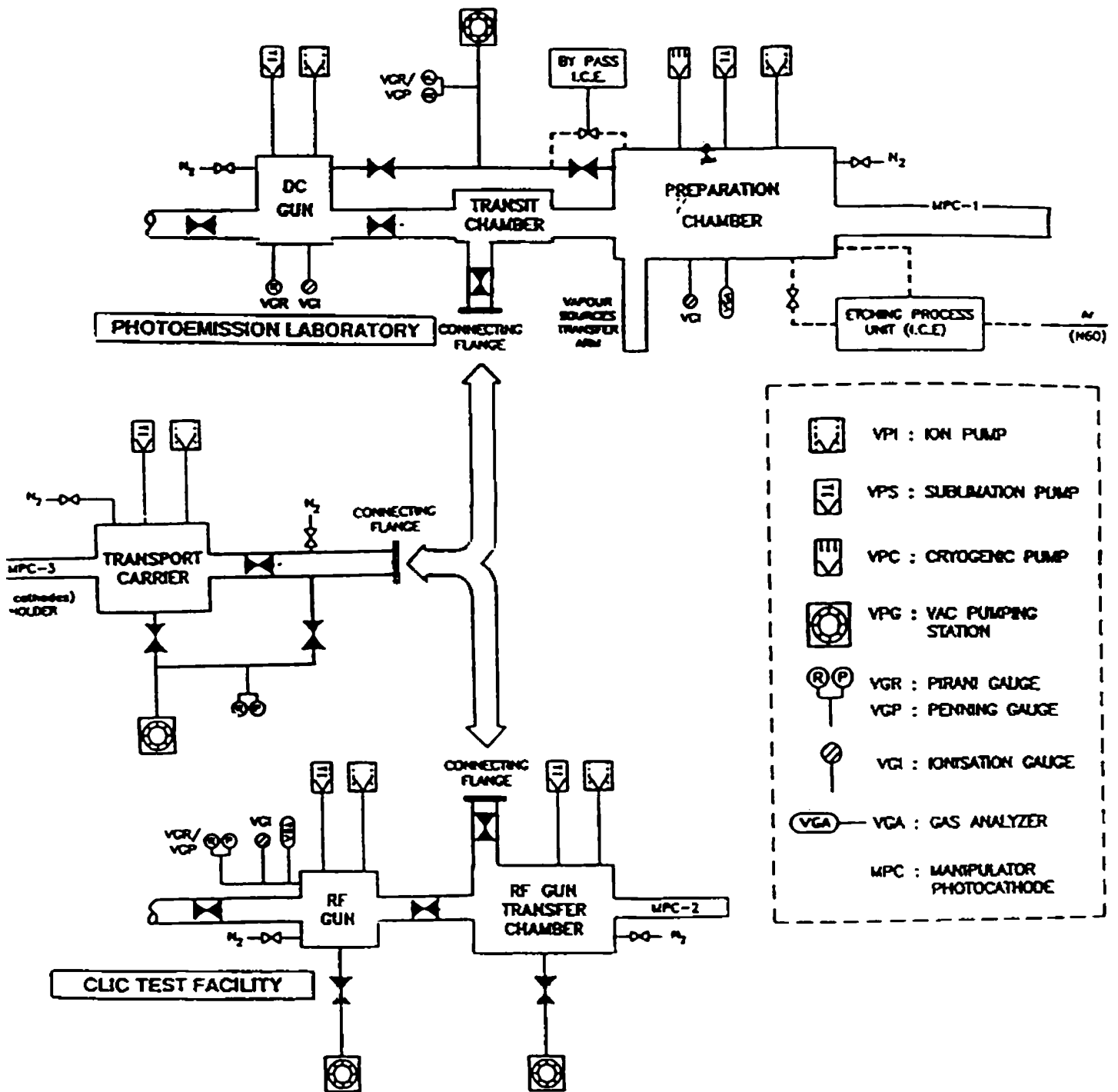

Fig 1



The photocathode transfer system

Fig 2

**Lightwave Electronics Corporation Model 130
Diode-pumped Mode-locked Nd:YLF Laser**

250 MHz 7 ps
1047 nm 0.6 nJ

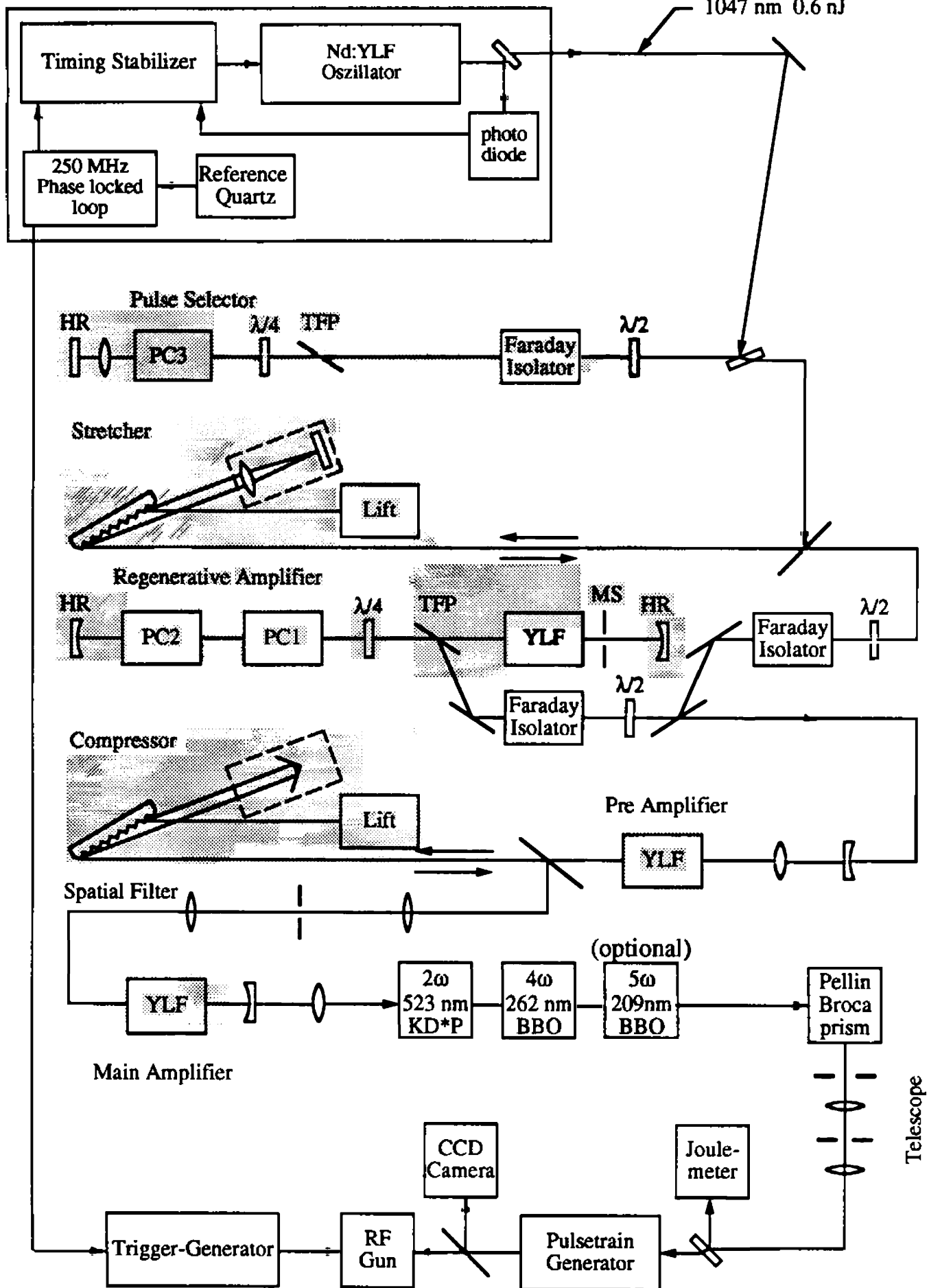

Synchro-Laser System for the CTF RF-Gun Run Nov/Dec 93

Pulse Train Generator

1 → 8

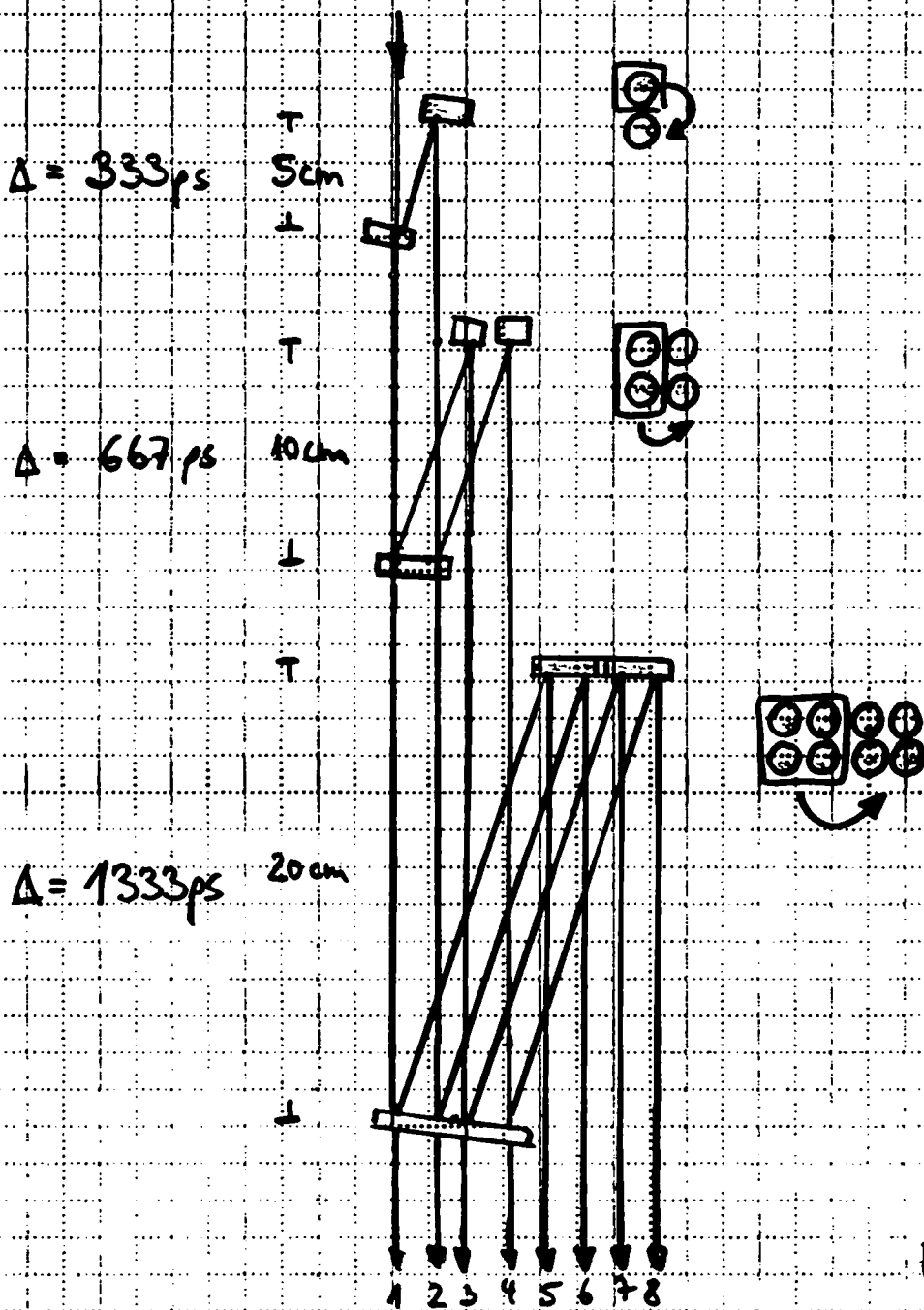
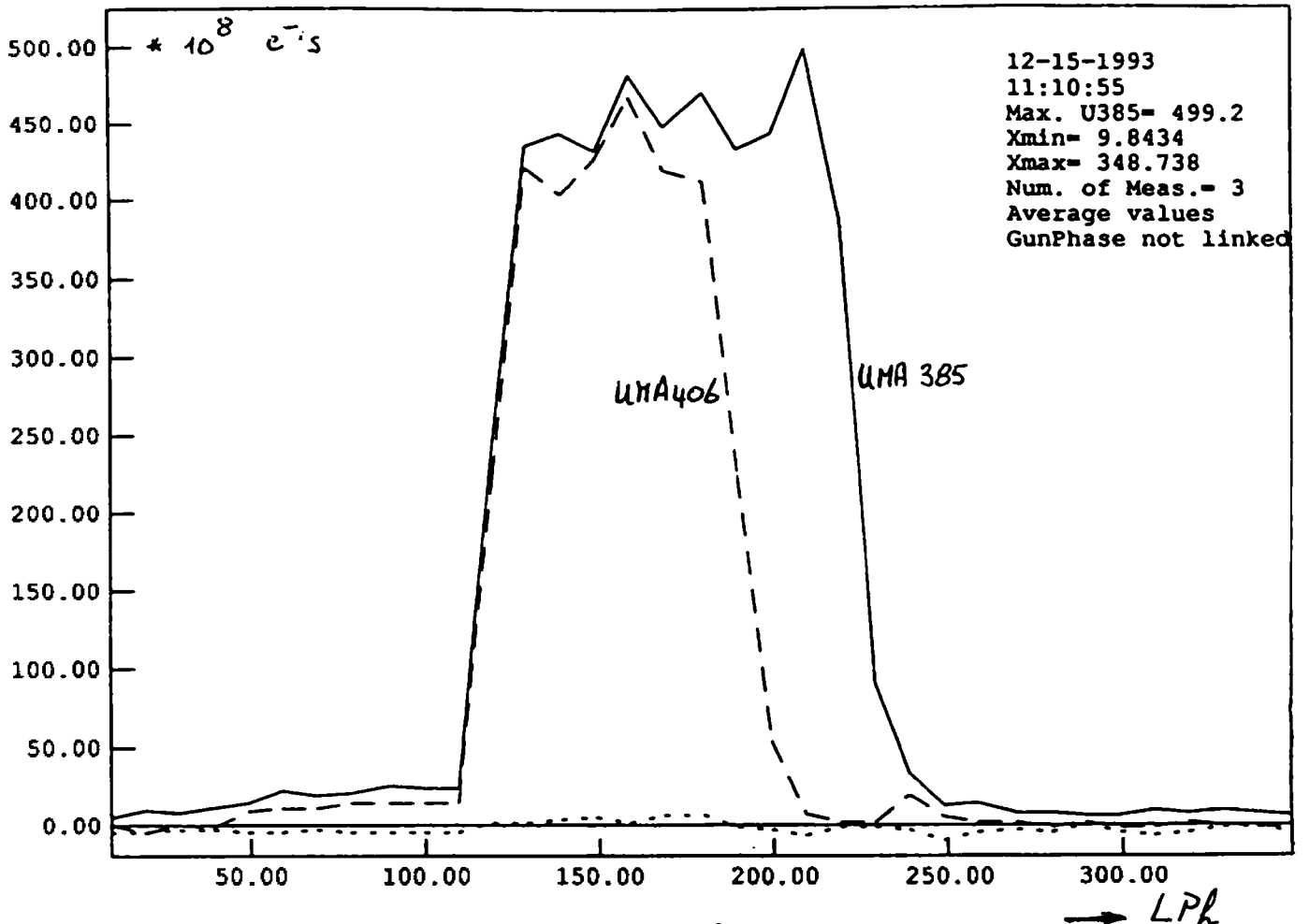
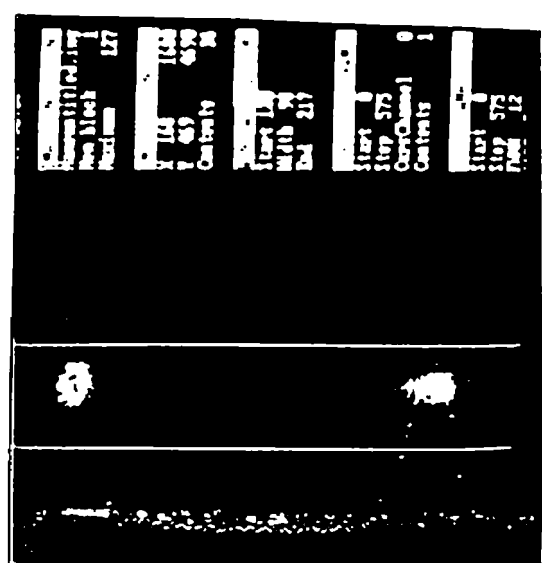

Fig 4



1 pulse twice!
 } GP = 490
 } LP = 134

Pockel ZF 112
 Laser: 2.5 μJ on Julemar
 Att: A.



1^{er} beam first train
 | < 4 ns
 1^{er} beam second train
 | <

Fig 5

Laser energy scan on Cs2Te cathode
for two values of the QE.

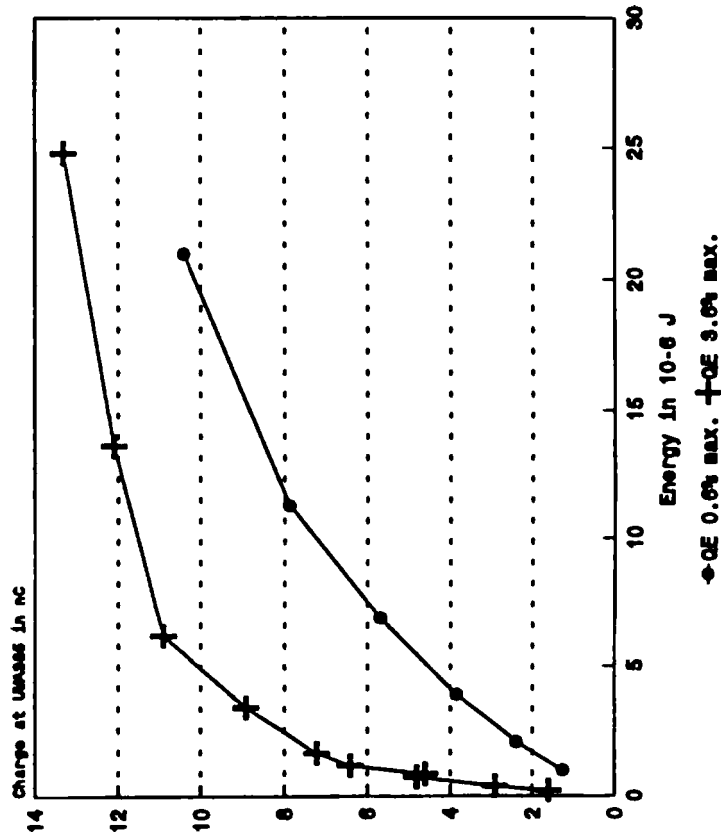

Single bunch. Laser spot approx. 1 cm^2
P-181 & 209, 25/11 & 8/12/1993

Laser energy scan on Cs2Te cathode
For two different spot sizes.

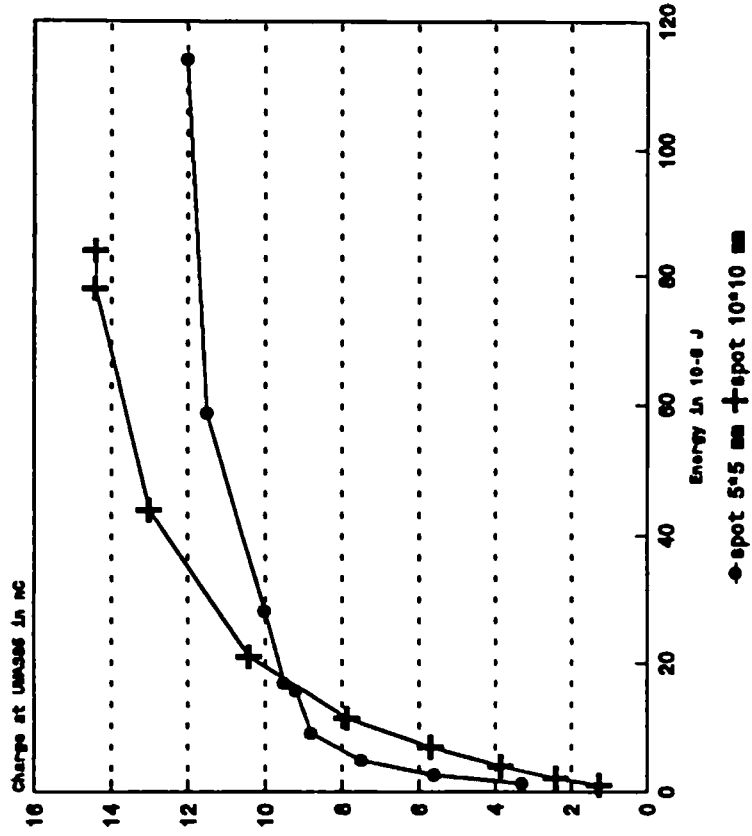

P-177 & 181, 25/11/93.

Fig 6

Percentage of bunch charge contributing to the total charge of the bunch train.

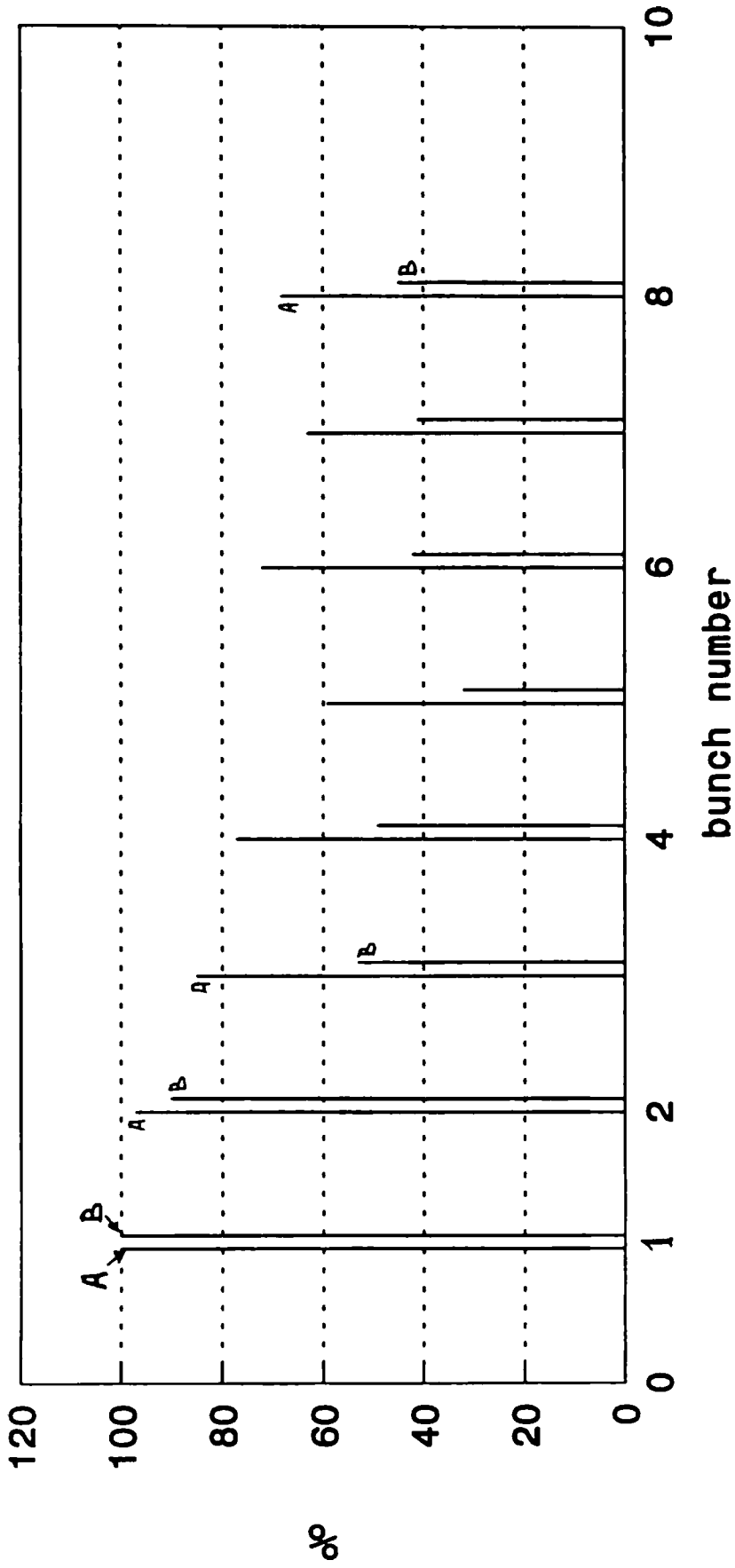

A:av.1.7nC,tot 13.7nC/B:av.3.05nC,tot 24.4nC

Trains with low / medium charge.p200/202
Train : 8 bunches
3/12/1993

Fig 7

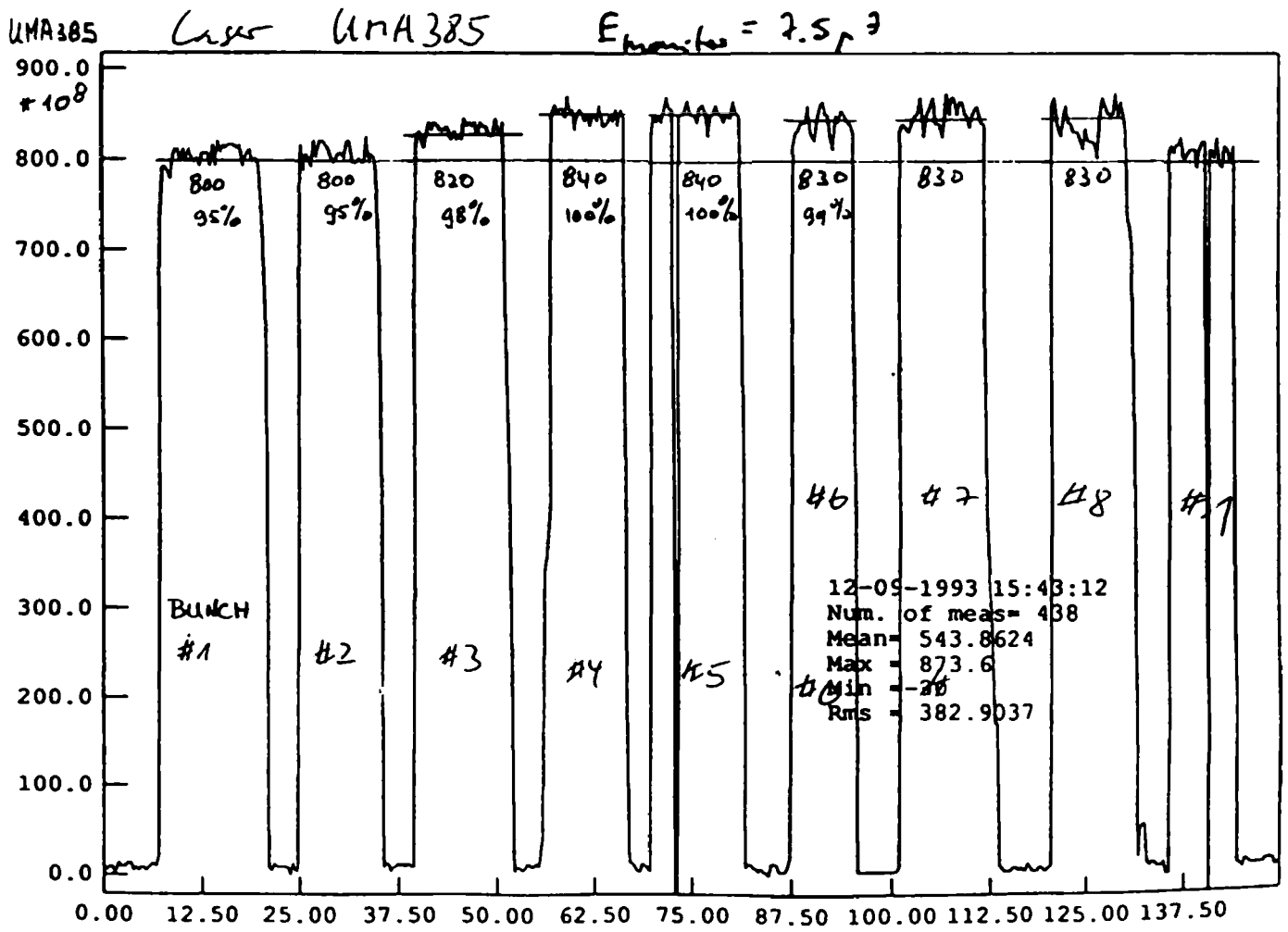
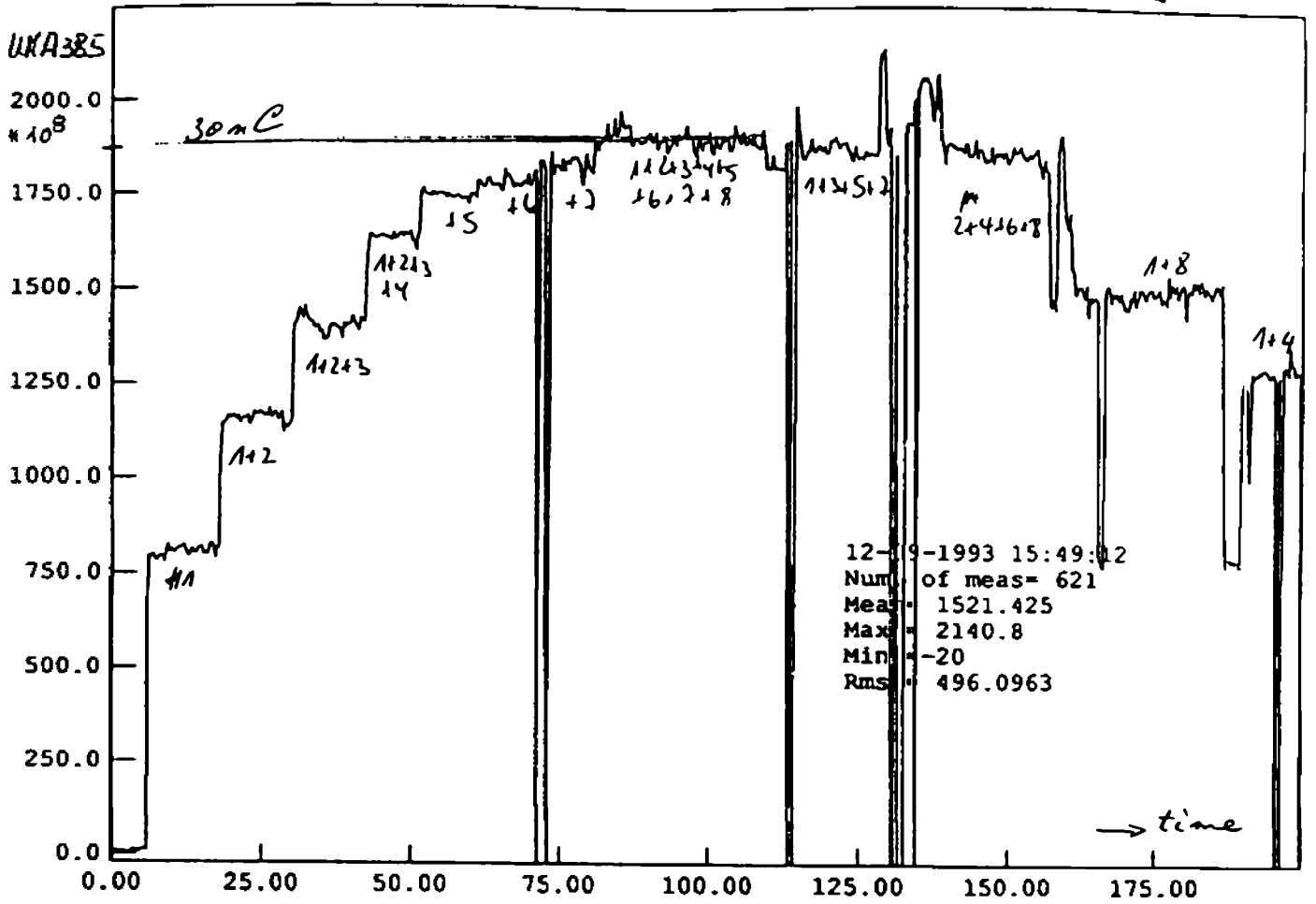

Beam transmission, single bunch.

Charge at UMA385/406/455

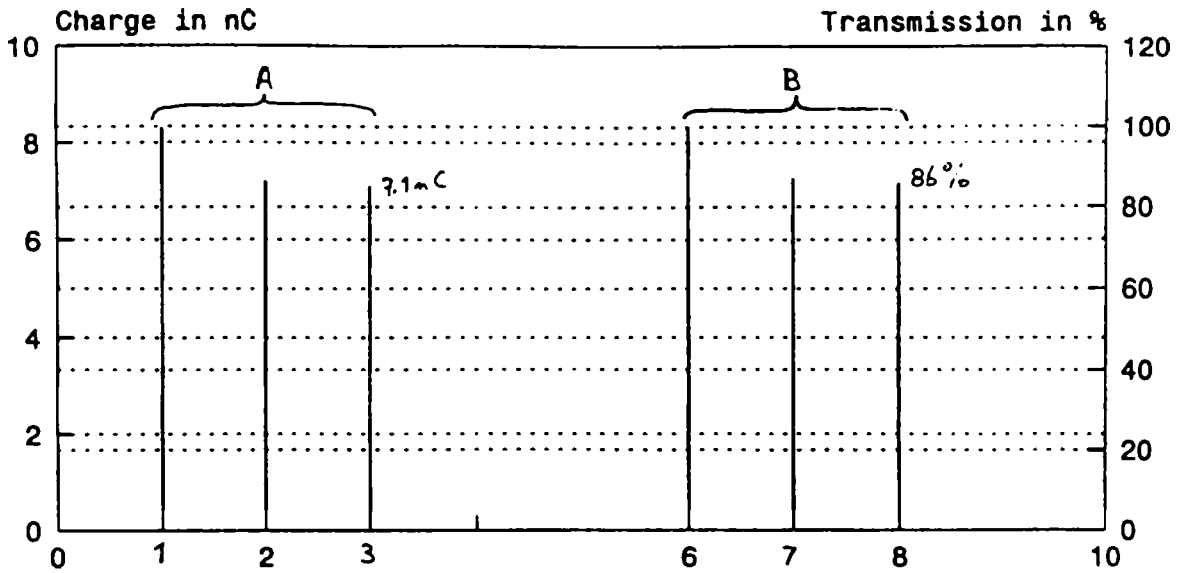

UMA385/406/455 : 1/2/3 and 6/7/8

A: Charge at 1/2/3/B: Transm. at 6/7/8

UMA385/406/455 : behind GUN/LAS/TRS
p.194; 29/11/1993

Beam transmission, single bunch

Charge at UMA385/406/455

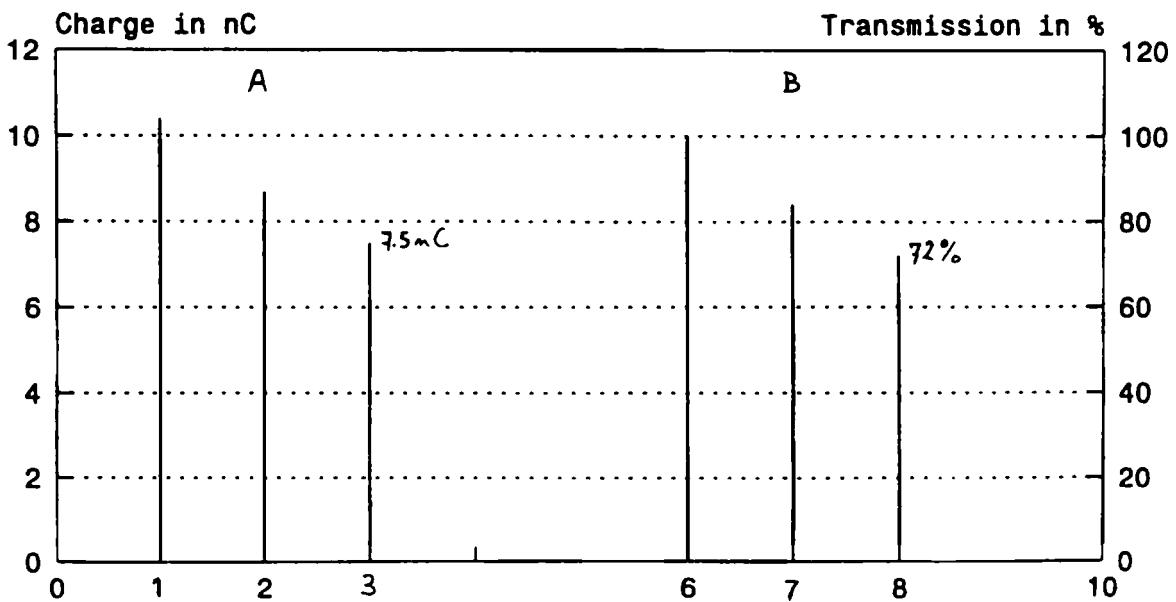

UMA385/406/455 : 1/2/3 and 6/7/8

A: Charge at 1/2/3/B: Transm. at 6/7/8

p.198; 29/11/1993

Beam transmission, train of 8 bunches.

Charge at UMA385/406/455.

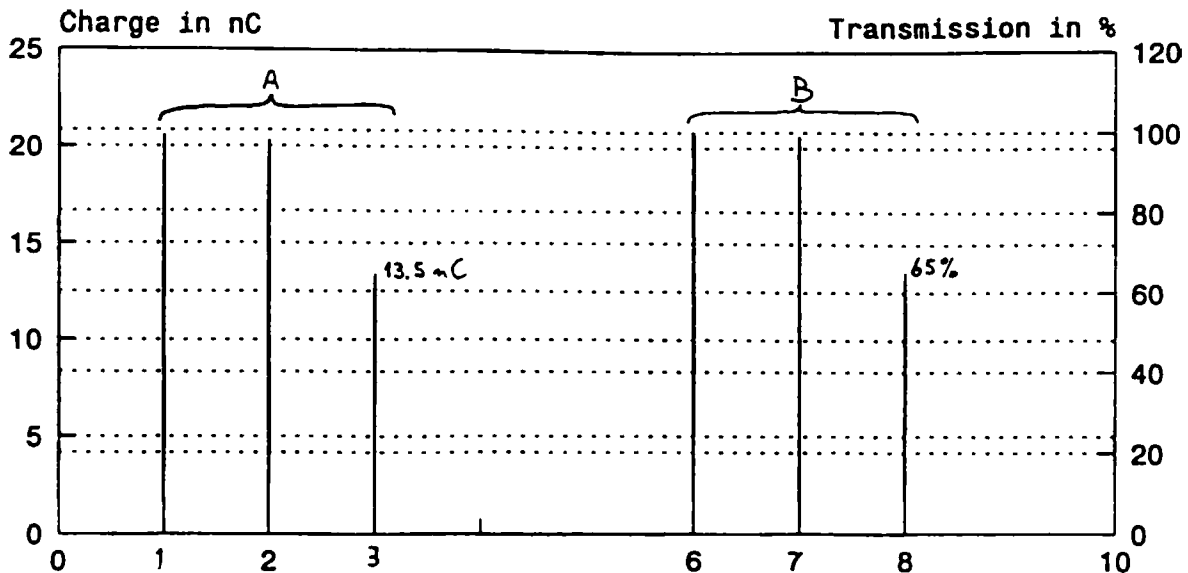

UMA385/406/455 : 1/2/3 and 6/7/8

A: Charge at 1/2/3 / B: Transm. at 6/7/8

Av. charge pb: 2.6nC; of train : 20.6nC

p.220 ; 14/12/1993

Beam transmission, 2 * 8 bunches.

Charge at UMA385/406/455.

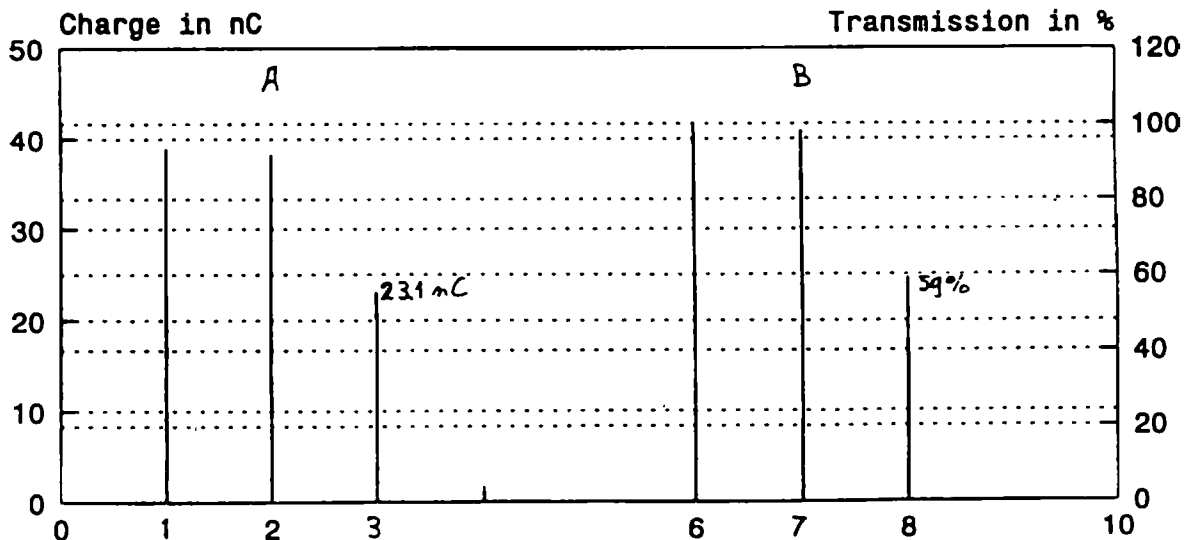

UMA385/406/455 : 1/2/3 and 6/7/8

Charge at 1/2/3 Transm. at 6/7/8

Av. charge pb.: 2.4nC; of trains : 39nC

Two trains of 8 bunches; between trains

4 missing bunches. p.224; 15/12/1993

Beam transmission, 24 bunches.

Charge at UMA385/406/455

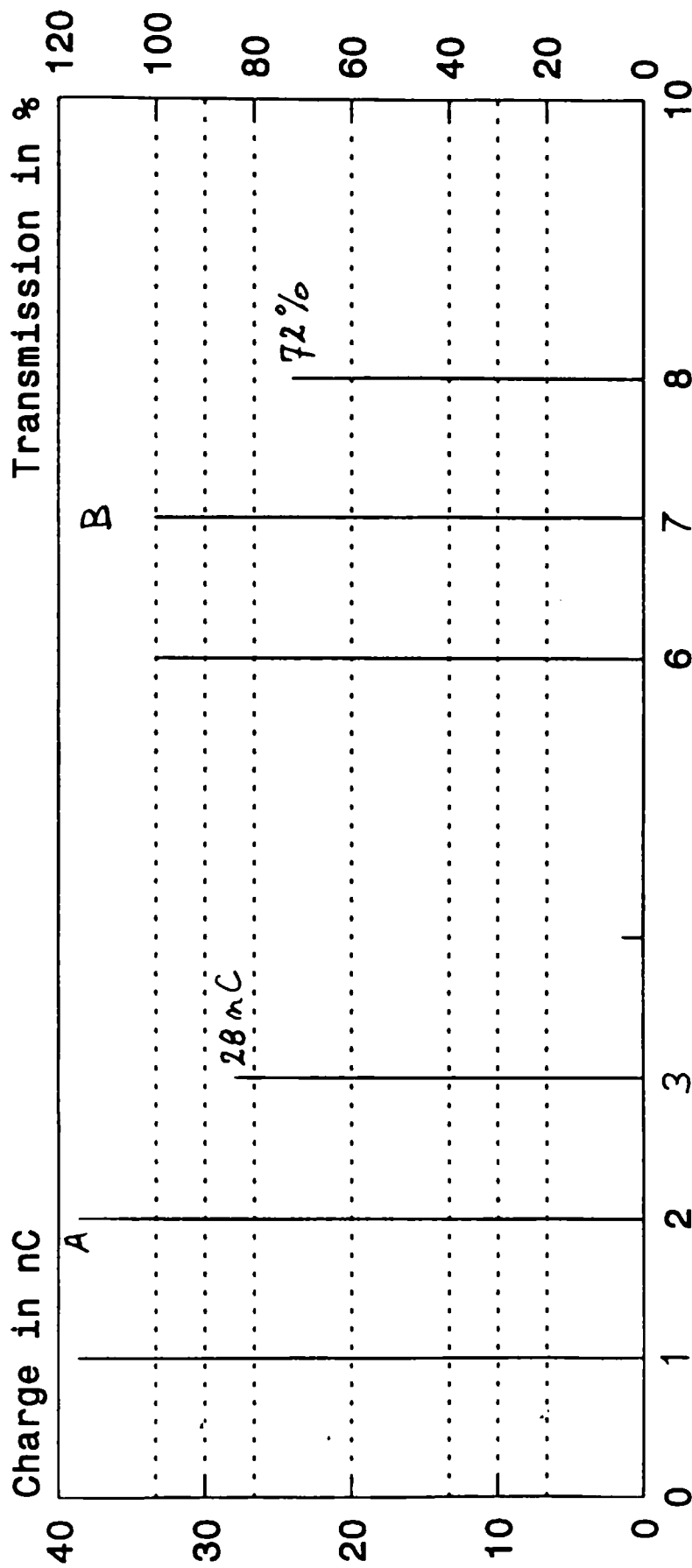

UMA385/406/455 : 1/2/3 and 6/7/8

A: Charge at 1/2/3/B: Transm. at 6/7/8

Fig 11

Av. charge pb : 1.6nC; of train : 38.6nC

Continuous bunch train

p.232 , 16/12/1993

UMA406=250 10^8

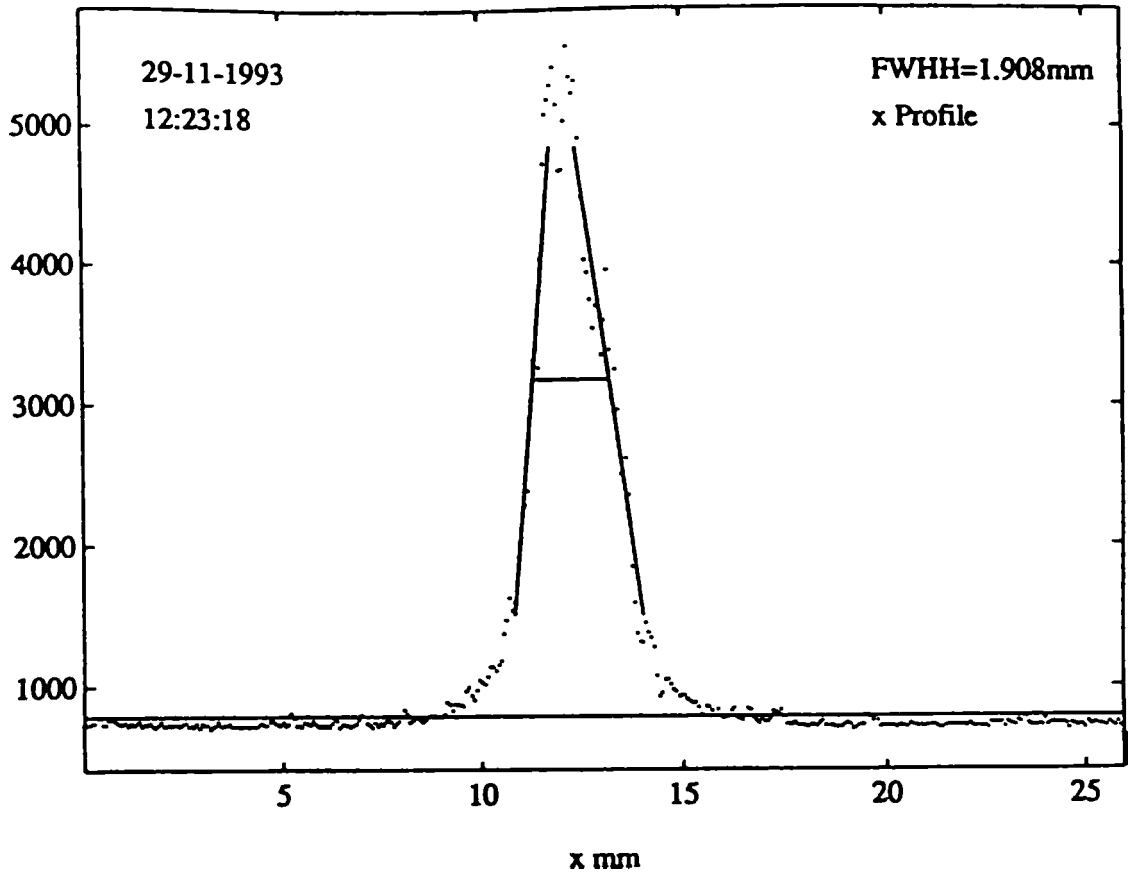

UMA406=250

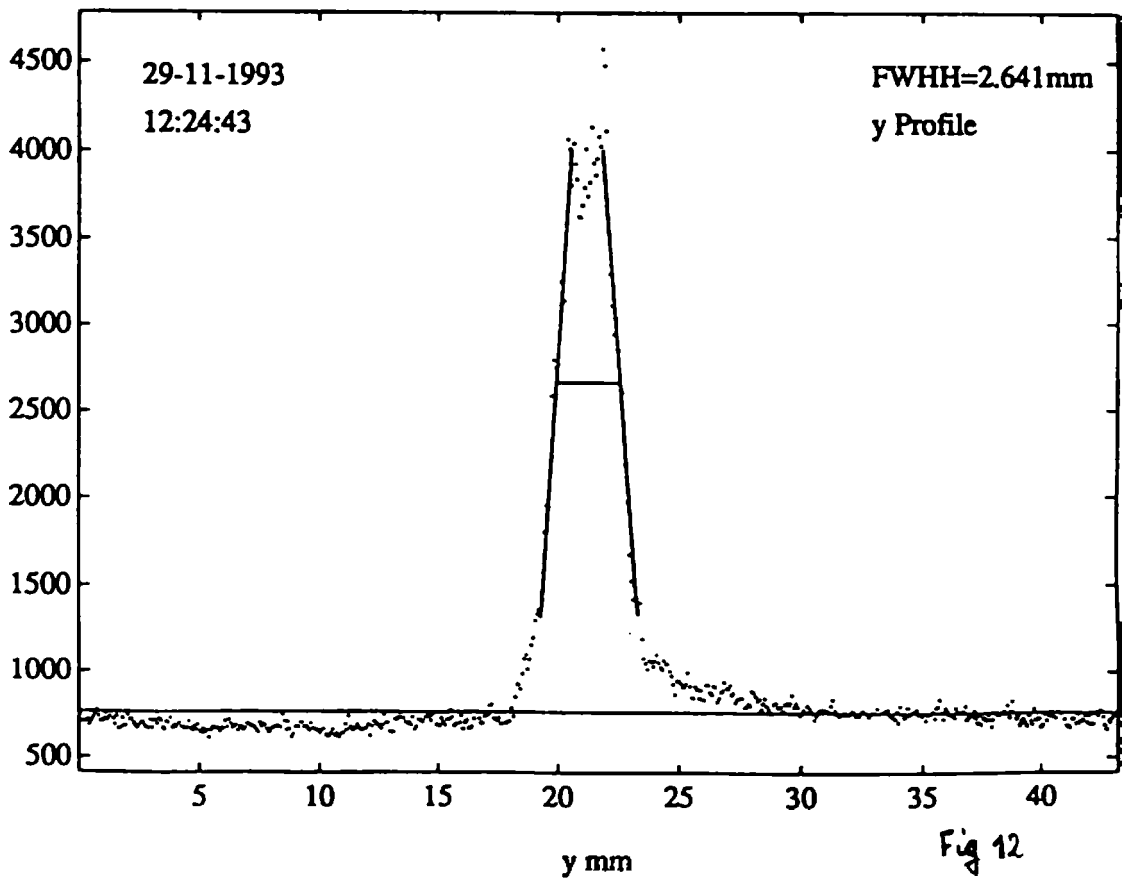

Fig 12

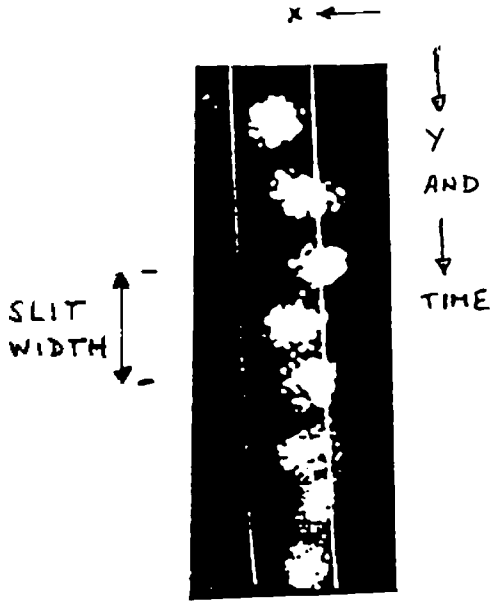
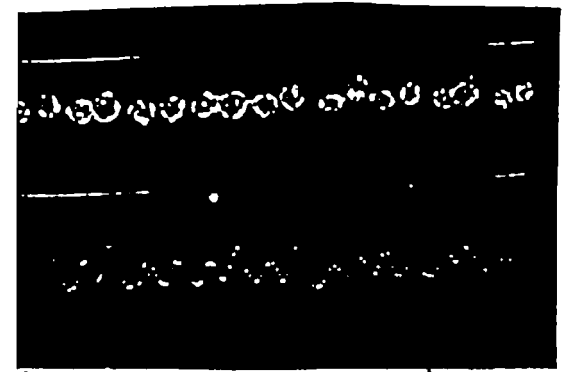
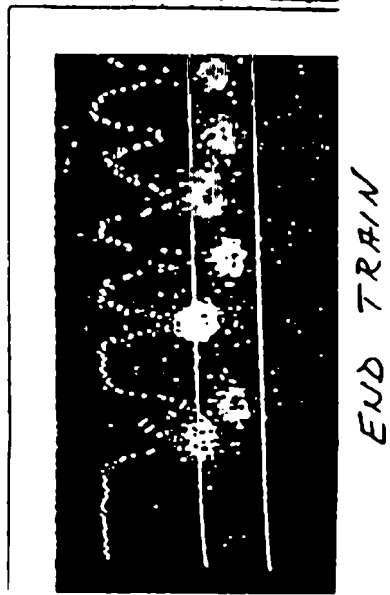
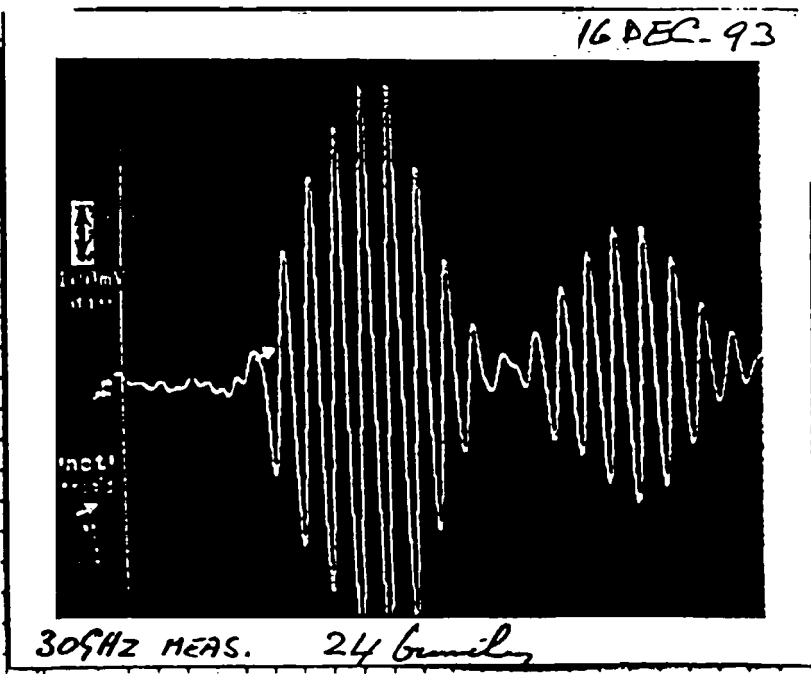
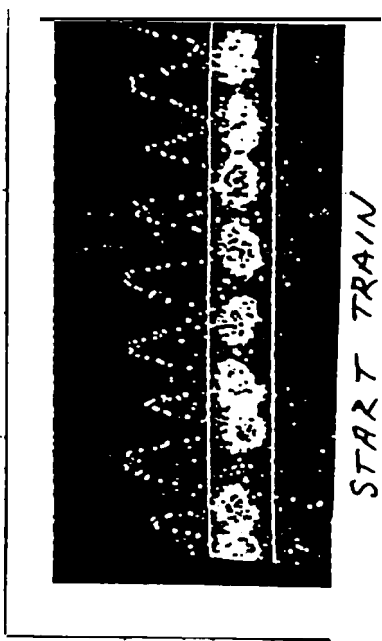

Fig 13

AS SLIT IS WIDE OPEN ; IF BUNCHES
SEEM TO BE CLOSER THEN IT IS A
POSITION SHIFT IN Y, NOT IN TIME

8 BUNCH TRAIN
TCM 445T AND STREAK CAMERA

24 BUNCH TRAIN



PART TRAIN WTA 406 = 9 nC

30 GHz power from TRS.
Measured and calculated.

Calculated 30GHz power with
F=0.539 and F=1.

drive beam	page	log	UMA406	UMA455	30 GHz	UMA406	UMA455	406	455	F=0.539	F=1.00
single bunch	186		7.7nC	5.5nC	640KW	503KW	257KW	1700KW	883KW	0.83	0.83
"	190		4.7	5.0	350	187	212	645	730	0.69	0.69
"	182		6.0	6.2	440	305	326	1100	1100	0.63	0.63
"	194		8.7	5.6	640	642	266	2200	915	0.84	0.84

8 bunches	204		15.9nC	12.2nC	8.0MW max.	2.1MW	1.3MW	7.4MW	4.3MW		
"	206		19.5	10.0	5.6	3.2	0.85	11.1	2.9		
"	220		15.1	12.9	7.5	1.9	1.4	6.7	4.9		
"	220		20.3	13.4	14.0	3.5	1.5	12.0	5.2		

2*8 bunches	224		38.3nC	23.1nC	20.5MW m.	11.4MW	4.1MW	39.4MW	14.3MW		
"	224		38.2	17.8	20.0	11.4	2.7	39.2	8.5		
"	222		31.5	20.5	17.0	7.7	3.3	26.7	11.3		
24 "	232		38.6	27.95	34.5	12.6	6.6	43.5	22.8		

TABLE 1

Distribution:

Autin B.	PS
Bossart R.	PS
Braun H.	PS
Brouet M.	AT
Chautard F.	PS
Corsini Roberto	PS
Delahaye J.-P.	PS
Fischer Claude	SL
Garoby, R.	PS
Geissler K.K.	AT
Godot J.-Cl.	PS
Guignard G.	SL
Hübner K.	PS
Hutchins S.	PS
Jensen E.	PS
Johnson C. D.	PS
Joly Pierre	PS
Kamber I.	PS
Koziol, H.	PS
Kugler H.	PS
Madsen J.H.B.	PS
Millich A.	SL
Nation John	SL
Pearce P.	PS
Potier J.-P.	PS
Riche A.J.	PS
Riege Hans	AT
Rinolfi L.	PS
Rossat G.	PS
Schnell W.	SL
Schreiber S.	AT
Suberlucq G.	PS
Thomi J.C.	PS
Thorndahl L.	PS
Warner D.J.	PS
Wilson I.	SL
Wuensch W.	SL