

Measurement of the CERN High Intensity RFQ
E. Tanke, M. Vretenar, M. Weiss

ABSTRACT

The RFQ2 is analyzed in view of its future installation as injector of the CERN Linac 2. Measurements comprising beam intensity, emittance, phase and energy spreads are performed for different parameter settings. A buncher (matching cavity) and magnetic quadrupoles placed downstream of the RFQ2 permit the study of the 6-D beam matching into Linac 2. The measurements are backed up by computations.

Paper presented at the 3rd EPAC,
European Particle Accelerator Conference, Berlin, March 24 - 28, 1992

Geneva, June 1992

Measurement of the CERN High Intensity RFQ

E. Tanke, M. Vretenar and M. Weiss
CERN, PS Division
CH - 1211 Geneva 23

Abstract

The RFQ2 is analyzed in view of its future installation as injector of the CERN Linac 2. Measurements comprising beam intensity, emittance, phase and energy spreads are performed for different parameter settings. A buncher (matching cavity) and magnetic quadrupoles placed downstream of the RFQ2 permit the study of the 6-D beam matching into Linac 2. The measurements are backed up by computations.

1. INTRODUCTION

The RFQ2, which has been put on the test stand at the beginning of 1990, has by now undergone a series of measurements and tests, in view of assessing its performance as future injector to CERN Linac 2. We recall some of its main parameters:

Table 1
RFQ2 Main Parameters

RF Frequency	f_0	202.56 MHz
Input Energy	W_{in}	90 keV
Output Energy	W_{out}	750 keV
Output Current	I_{out}	> 200 mA
Trapping Efficiency	η	~ 90 %

During measurements, it was found that the input matching parameters, established by two solenoids and an Einzel lens in the accelerating column, were not critical, as variations of up to $\pm 5\%$ around nominal settings affected the output beam characteristics only slightly.

Output beams of ~ 225 mA were routinely obtained, which, by increasing the input beam intensity and vane voltage (both by about 10%), could be pushed up to 250 mA. Emittance, energy spread and phase spread measurements showed repeatable results over longer periods. Measurements were accompanied by computations in order to increase our understanding of the RFQ2 operation.

The experimental set-up is shown in Fig. 1. The horizontal slit of the emittance device was used also for energy spread measurements. The vertical slit could be replaced by a fast probe for phase spread investigations.

During the 1993 January-February shut-down, the RFQ2 will replace the Cockcroft-Walton generator and the low energy beam transport of Linac 2. This replacement is also part of the improvements to the PS complex required by the future LHC accelerator. We shall have two RFQ2s (the second one is being constructed at the CERN Main Workshop), of which one will be installed at Linac 2, the other serving both as spare and as test facility in the experimental area.

2. BEAM MEASUREMENTS

These measurements are conveniently divided into transverse and longitudinal phase plane tests. The output beam intensity for all measurements was >200 mA, usually around 220 mA.

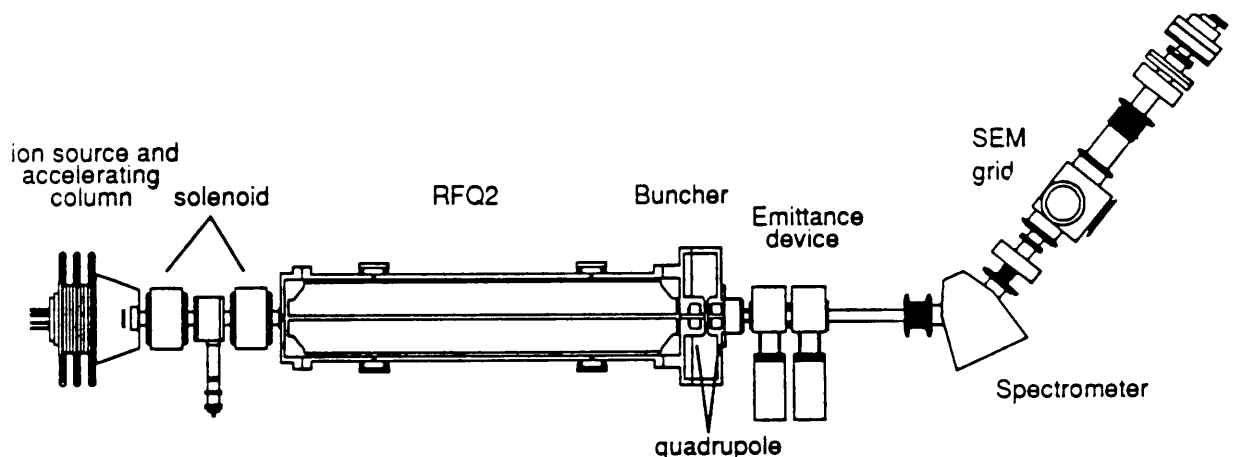
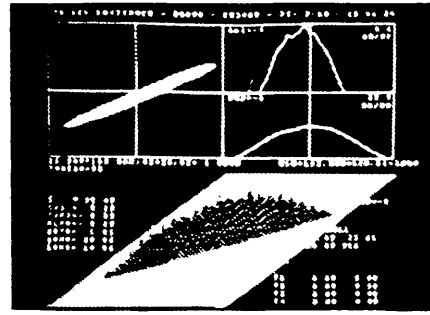
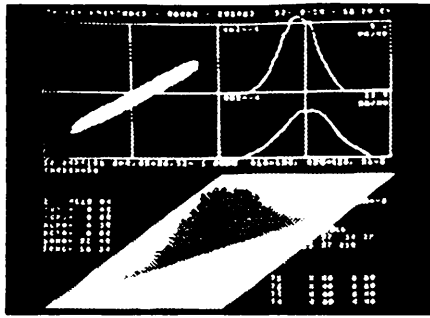

Figure 1. RFQ2 on its test stand

Horizontal
plane



Vertical
plane

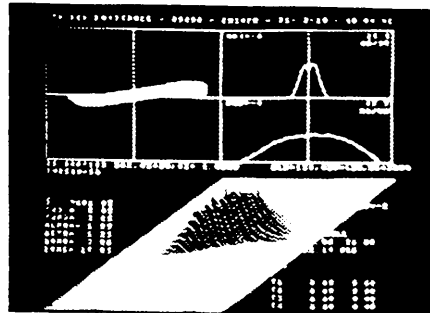
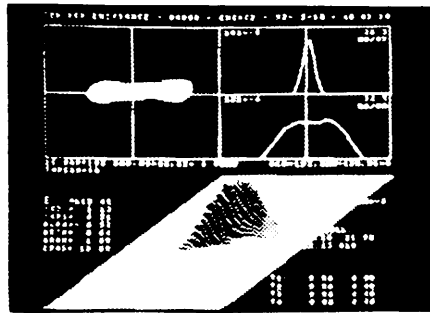

Figure 2. 95% Transverse Emittances with Buncher off (left) and on (right)

2.1. Transverse Phase Plane

The emittances have been measured with the buncher on and off. Note that the buncher acts here as a lens in the longitudinal phase plane, required for a good beam match into Linac 2. The emittances shown in Fig. 2 are for 95% of the beam intensity; during the measurements, the settings of the two focusing quadrupoles, situated in the drift tubes of the buncher, were kept constant. These settings were somewhat too high for the operation with buncher off, giving a reduced beam waist and then, due to increased space charge action, a slightly increased emittance. The normalized rms emittance values, corresponding to 90% and 95% of the beam (defined by a threshold setting), are quoted below:

Table 2

RFQ2 Transverse Emittances $\mathcal{E}_{\text{rms},n}$ (π mm mrad)

	Buncher off	Buncher on
Horizontal, 90%	0.55	0.53
Vertical, 90%	0.65	0.60
Horizontal, 95%	0.65	0.60
Vertical, 95%	0.75	0.70

The emittances are quoted as measured. The precision of such measurements depends, among other things, on the form of the emittance, being reduced for beams with small divergences [1]. The vertical emittance is in our case bigger, as is always the case in the plane where focusing in the RFQ occurred last (except for RFQs with exit matching section).

2.2 Longitudinal Phase Plane

The energy spread has been measured with an analyzing slit as object, a 51° spectrometer magnet and a 23 wire collector (SEM grid) in the image plane. The inclination of the collector did not follow exactly the image plane, hence the borders of the energy spread curves are somewhat pessimistic. The energy spread has been measured for different buncher voltages, starting from zero. The measurements were stored and analyzed with the computer (mean energy and rms values).

The phase spread has also been measured for different buncher voltages, with a fast probe [2] and a 1.2 GHz oscilloscope. Phase and energy spreads are presented in Fig.3.

3. COMPUTATIONAL BACK UP

The same computer programs, which have been used for the design of the RFQ2 and the transport line towards Linac 2, have also been used to compare measurements and computations. The computations start with a matched beam at the input to the RFQ2 (simulation program) and end at the position of the slits, where all the measurements have taken place. The agreement between measurements and computations is judged as very satisfactory. Of course differences exist (the computations are always somewhat "ideal", concerning density distributions in the beam, perfect matching and steering, no neutralization, etc.), but the overall behavior of the real beam closely approaches the design values. In Fig. 4 the measured and computed emittances in all three phase planes are represented.

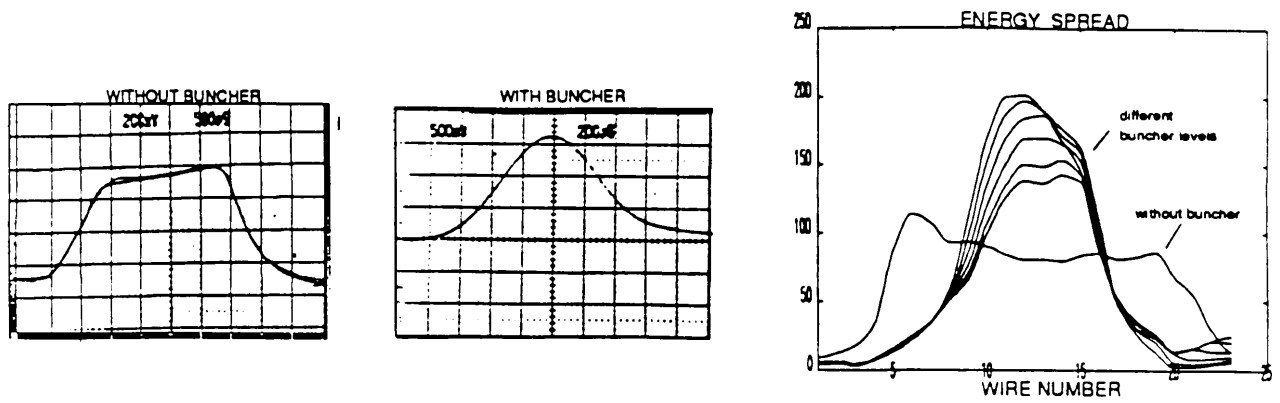

Figure 3. Phase Spread ($36^\circ/\text{div.}$ left, $14.4^\circ/\text{div.}$ right) and Energy Spread (6.25 keV/wire) of RFQ2 Beam

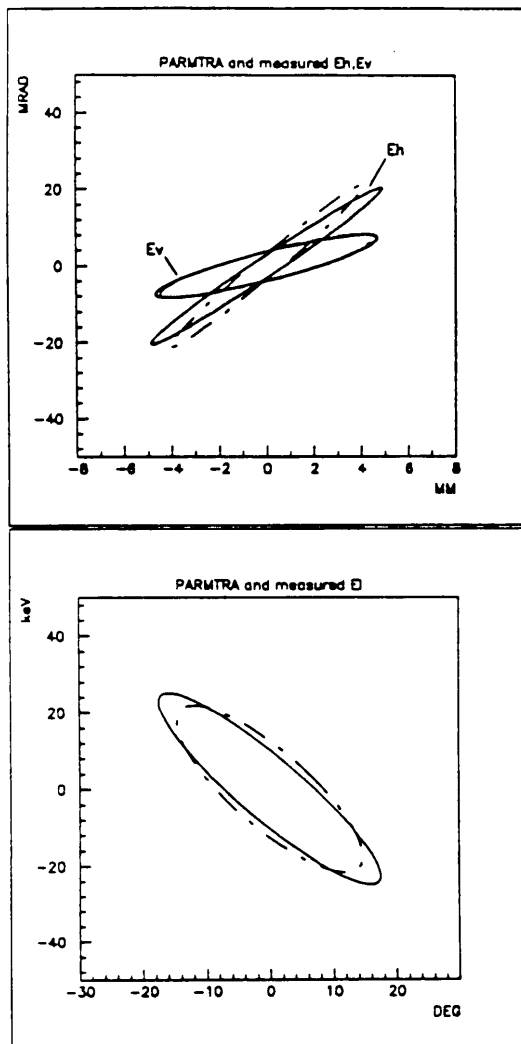

Figure 4. Measured (continuous) and computed (dashed) rms unnormalized emittances of RFQ2

4. RELIABILITY OF RFQ2

The high peak electric fields of the RFQ2 (up to 2.5 times the Kilpatrick limit) require a careful test of the reliability of this accelerator. This was even more important, as the RFQ2

had to be cleaned and slowly reconditioned after having suffered an accidental oil pollution [3]. During 1991 the RFQ2 has been operated at the nominal RF field level for more than 3000 hours, with more than 400 hours with full beam. The number of missing pulses due to breakdowns in the cavity could be as high as about 100 per day, always linked to an improper functioning of the vacuum system. Improving progressively the cleanliness one ended up, finally, with an average of less than one missing pulse per day. Note that the vacuum system is completely revised for the RFQ2 installation at Linac 2.

5. CONCLUSION

The tests of the RFQ2 have shown that this accelerator is suitable and reliable as injector into Linac 2. Higher beam currents than the nominal 200 mA have been achieved; the transverse emittances, comparable to the present LEBT emittances, are still somewhat small for Linac 2, where now an emittance increase of about 2.5 times occurs in tank 1, due to space charge action.

6. ACKNOWLEDGMENTS

During the measurements, we have been helped by several people, in particular G. Amendola, H. Charmot and J.P. Romero. We thank them all.

7. REFERENCES

- [1] J.Guyard and M.Weiss, "Use of Beam Emittance Measurements in Matching Problems", Proceedings of the 1976 Proton Linear Accelerator Conference, Chalk River, Ontario, November 1976, pp. 254-258.
- [2] J.Knott, "Measurements of the Instantaneous 200 MHz Bunch Currents at 750 keV for the CERN Linac 2", Proceedings of the 1983 Particle Accelerator Conference on Accelerator Engineering and Technology, Santa Fe, New Mexico, March 1983, pp. 2244-2246.
- [3] E.Tanke, M.Vretenar and M.Weiss, "Performance of the CERN High Intensity RFQ", Proceedings of the 1990 Linear Accelerator Conference, Albuquerque, New Mexico, September 1990, pp. 686-688.