



Search for pair-production of vector-like quarks in pp collision events at $\sqrt{s} = 13$ TeV with at least one leptonically decaying Z boson and a third-generation quark with the ATLAS detector

The ATLAS Collaboration

A search for the pair-production of vector-like quarks optimized for decays into a Z boson and a third-generation Standard Model quark is presented, using the full Run 2 dataset corresponding to 139 fb^{-1} of pp collisions at $\sqrt{s} = 13$ TeV, collected in 2015–2018 with the ATLAS detector at the Large Hadron Collider. The targeted final state is characterized by the presence of a Z boson with high transverse momentum, reconstructed from a pair of same-flavour leptons with opposite-sign charges, as well as by the presence of b -tagged jets and high-transverse-momentum large-radius jets reconstructed from calibrated smaller-radius jets. Events with exactly two or at least three leptons are used, which are further categorized by the presence of boosted W , Z , and Higgs bosons and top quarks. The categorization is performed using a neural-network-based boosted object tagger to enhance the sensitivity to signal relative to the background. No significant excess above the background expectation is observed and exclusion limits at 95% confidence level are set on the masses of the vector-like partners T and B of the top and bottom quarks, respectively. The limits depend on the branching ratio configurations and, in the case of 100% branching ratio for $T \rightarrow Zt$ and 100% branching ratio for $B \rightarrow Zb$, this search sets the most stringent limits to date, allowing $m_T > 1.60$ TeV and $m_B > 1.42$ TeV, respectively.

Contents

1	Introduction	2
2	ATLAS detector	3
3	Data and simulated event samples	4
4	Object reconstruction	5
5	Event selection and categorization	6
6	Systematic uncertainties	10
7	Results	12
8	Conclusions	19

1 Introduction

The Standard Model (SM) has had astonishing success in describing the interactions of elementary particles, culminating in the discovery [1, 2] of the Higgs boson by the ATLAS and CMS collaborations. Nevertheless, there remain some shortcomings, such as the quadratically divergent corrections predicted to contribute to the square of the Higgs boson mass [3]. In many theories beyond the SM, including Composite Higgs [4, 5] and Little Higgs [6, 7] models, a recurrent theme that addresses these issues is the existence of vector-like quarks (VLQs): coloured spin-1/2 fermions that have left- and right-handed components transforming identically under the SM gauge group. In such models, VLQs are often assumed to couple preferentially to a third-generation quark [8–11], potentially regulating the divergent corrections to the Higgs boson mass. The VLQs therefore decay into SM quarks and a W/Z (V) or Higgs (H) boson, with branching ratios (BR) that depend on the VLQ masses and their configuration in weak-isospin multiplets. In renormalizable extensions of the SM that include VLQs, the canonical representation of VLQs constitutes one of seven multiplets: two singlets, three doublets, and two triplets. Vector-like partners, T and B , of the top and bottom quarks can exist with electric charges $(2/3)e$ and $-(1/3)e$, respectively, and can be arranged in singlets, doublets, and triplets. VLQs with exotic charges can also exist, namely X and Y with electric charges $(5/3)e$ and $-(4/3)e$, respectively, which can be arranged in doublets and triplets with the T and B . Assuming an almost degenerate VLQ mass hierarchy [11], the singlet and triplet representations are phenomenologically similar in terms of chiral structure and BR composition. As a consequence, the singlet and doublet representations are those that are primarily assumed in searches at the Large Hadron Collider (LHC). While models with extreme values of 100% BR for decay into a third-generation quark and either a W/Z boson or a Higgs boson are often used as benchmarks, intermediate BR configurations are expected in the more physically motivated singlet and doublet models. In the former, the BR for $T \rightarrow Zt$ or $B \rightarrow Zb$ reaches $\approx 25\%$ at high VLQ masses [11]. For the (T, B) and (X, Y) doublets the BR for $T \rightarrow Zt$ reaches $\approx 50\%$ [11], as does the BR for $B \rightarrow Zb$ for the (B, Y) doublet.

VLQs were searched for at ATLAS and CMS focusing mainly on the pair-production mode [12–25]. Constraints on VLQ production were also derived recently [26] from a range of differential cross-section measurements at the LHC, complementing the direct searches. VLQ pair production, proceeding primarily

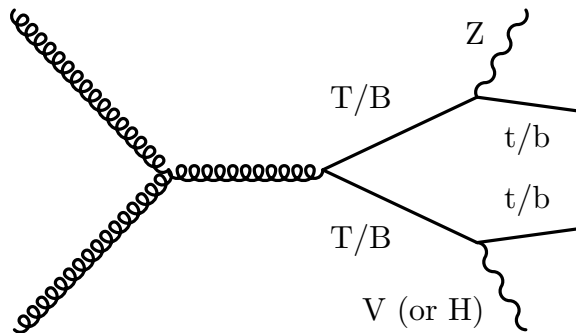

Figure 1: Feynman diagram showing the pair production of T or B quarks in which at least one of the VLQs decays into a Z boson in association with a SM t - or b -quark, respectively. In this analysis, events in which the Z boson decays into a pair of electrons or a pair of muons are targeted. At least one b -tagged jet is required to be present after pair production of either type of VLQ, and additional leptons can be produced in the decays of V (W/Z), or H bosons on the second leg of the VLQ pair production.

via the strong interaction with a cross-section that depends only on the VLQ mass, is expected to be the dominant mode for masses up to approximately 1 TeV. The most stringent limits at 95% confidence level (CL) on T and B masses depend on the assumed BR configuration; for 100% BR for $T \rightarrow Zt$, $T \rightarrow Ht$, $T \rightarrow Wb$, and $B \rightarrow Wt$, masses up to 1.48 TeV, 1.50 TeV, 1.50 TeV, and 1.56 TeV are excluded, respectively [25]. For 100% BR for $B \rightarrow Zb$ and $B \rightarrow Hb$, B masses up to 1.39 TeV and 1.57 TeV are excluded, respectively [20]. A singlet T is excluded for masses below 1.48 TeV and a singlet B is excluded for masses below 1.47 TeV, while in the (T, B) doublet case, T and B masses below 1.49 TeV and 1.37 TeV are excluded, respectively [12, 25, 26]. Single VLQ production has also been searched for [13, 15, 27–33], but the interpretation [34] of the search results depends on an additional coupling constant for the coupling to electroweak bosons.

This Letter presents a search for pair production of T and B in events with at least two electrons or muons where at least two same-flavour leptons with opposite-sign charges originate from the decay of a Z boson. Various BR configurations for the decay of the VLQ into a V or H boson and a third-generation quark are considered, including the singlet and doublet models, assuming that only one type of VLQ is present, and it is also assumed that the VLQ signal kinematics are similar for different configurations. It is further assumed that the production of VLQ pairs is dominated by the strong interaction and that the contribution from electroweak processes is negligible. A diagram illustrating the targeted event topologies is shown in Figure 1. The search is performed across several different event categories included in a maximum-likelihood fit, improving on a previous ATLAS search [13] in the same final state. In addition to benefiting from the larger dataset, the search is also improved by the use of a deep neural network (DNN) to classify the jets in each event as originating from either a Z or W boson, H boson, or top quark.

2 ATLAS detector

ATLAS [35] is a multipurpose particle detector at the Large Hadron Collider (LHC) with a forward–backward symmetric cylindrical geometry and a near 4π coverage in solid angle.¹ It consists of an

¹ ATLAS uses a right-handed coordinate system with its origin at the nominal interaction point (IP) in the centre of the detector and the z -axis along the beam pipe. The x -axis points from the IP to the centre of the LHC ring, and the y -axis points

inner tracking detector (ID) [36, 37] surrounded by a thin superconducting solenoid providing a 2 T axial magnetic field, electromagnetic and hadron calorimeters, and a muon spectrometer (MS). The ID covers the pseudorapidity range $|\eta| < 2.5$ and consists of silicon pixel, silicon microstrip, and transition radiation tracking detectors. Lead/liquid-argon (LAr) sampling calorimeters provide electromagnetic (EM) energy measurements with high granularity. A steel/scintillator-tile hadronic calorimeter covers the central pseudorapidity range ($|\eta| < 1.7$). The endcap and forward regions are instrumented with LAr calorimeters for both EM and hadronic energy measurements up to $|\eta| = 4.9$. The MS surrounds the calorimeters and uses three large air-core toroidal superconducting magnets with eight coils each. The field integral of the toroids ranges between 2.0 and 6.0 T m across most of the detector. The MS includes a system of precision chambers for tracking and fast detectors for triggering [38]. A two-level trigger system is used to select events. The first-level trigger is implemented in hardware and uses a subset of the detector information to accept events at a rate below 100 kHz. This is followed by a software-based trigger that reduces the accepted event rate to 1 kHz on average depending on the data-taking conditions. An extensive software suite [39] is used in the reconstruction and analysis of real and simulated data, in detector operations, and in the trigger and data acquisition systems of the experiment.

3 Data and simulated event samples

The analysed dataset comprises pp collisions at a centre-of-mass energy $\sqrt{s} = 13$ TeV recorded by ATLAS between 2015 and 2018 with all detector subsystems operational and with the LHC operating in stable beam conditions with 25 ns bunch spacing. The combined Run 2 dataset corresponds to an integrated luminosity of 139 fb^{-1} with an average of about 34 simultaneous interactions per bunch crossing (pile-up).

All the nominal Monte Carlo (MC) simulation samples used in the analysis were produced with the ATLAS full-simulation framework [40] based on GEANT4 [41]. In all samples, pile-up was modelled by combining simulated inelastic pp events with the physics event. The nominal sample for Z boson production in association with jets (Z +jets) was generated with SHERPA 2.2.1 [42–45] and the nominal diboson (VV) sample was generated with SHERPA 2.2.2, with the NNPDF3.0 [46] next-to-next-to-leading-order (NNLO) parton distribution function (PDF) set. The Z +jets sample includes events generated with up to two partons at next-to-leading order (NLO) and up to four partons at leading order (LO) and is normalized to the NNLO cross-section [47]. The VV sample is normalized to the SHERPA NLO cross-section and includes $q\bar{q}$ -initiated events with up to one parton at NLO and up to three partons at LO and gg -initiated processes generated using LO matrix elements for up to one additional jet. For both samples, COMIX [44] and OPENLOOPS [48] were used and the matrix element (ME) was merged with the SHERPA parton shower [45] according to the MEPS@NLO prescription [49]. To estimate modelling uncertainties, an additional Z +jets sample was produced with MADGRAPH5_AMC@NLO 2.2.3 [50], using the NNPDF3.0_{NLO} PDF set and interfaced to PYTHIA 8.210 [51] with the A14 set of tuned parameters (tune) [52] and the NNPDF2.3_{LO} PDF for showering. These samples were generated including LO matrix elements for up to four jets [53].

The nominal SM $t\bar{t}$ background sample uses the POWHEG method [54, 55] implemented in POWHEG BOX v2 [56, 57] with the NNPDF3.0_{NLO} PDF set. POWHEG BOX was interfaced with PYTHIA 8.230 with the A14 tune for showering. The sample is normalized to the NNLO cross-section in QCD including resummation of next-to-next-to-leading logarithmic (NNLL) soft gluon terms calculated with TOP++ [58–64]. For

upwards. Cylindrical coordinates (r, ϕ) are used in the transverse plane, ϕ being the azimuthal angle around the z -axis. The pseudorapidity is defined in terms of the polar angle θ as $\eta = -\ln \tan(\theta/2)$. Angular distance is measured in units of $\Delta R \equiv \sqrt{(\Delta\eta)^2 + (\Delta\phi)^2}$.

the evaluation of modelling uncertainties, samples were produced with the same ME generator as the nominal sample, but HERWIG 7 was used with the H7-UE-MMHT tune [65] for the showering. Additional samples [66] were generated with MADGRAPH5_AMC@NLO 2.3.3 and the NNPDF3.0_{NLO} PDF set, using the same showering configuration as the nominal sample.

The nominal sample including $t\bar{t}$ production in association with a vector boson ($t\bar{t} + X$) was generated with MADGRAPH5_AMC@NLO 2.3.3 interfaced with PYTHIA 8.210 for showering, using the NNPDF2.3_{LO} PDF set and the A14 tune. The sample includes $t\bar{t} + Z$ and $t\bar{t} + W$ events normalized to the NLO cross-sections calculated with MADGRAPH5_AMC@NLO. To evaluate modelling uncertainties, samples were produced using SHERPA 2.2.1. Alternative samples were also produced with the nominal sample's ME generator, and in these samples either the A14 tune was varied or HERWIG 7 was used with the H7-UE-MMHT tune for the showering. The nominal $t\bar{t} + X$ sample also includes $t\bar{t}t\bar{t}$ and $t\bar{t}WW$ events generated at LO and normalized to cross-sections calculated [50, 67] with NLO QCD and EW corrections.

The single-top processes were simulated with POWHEG BOX [68, 69] using the NNPDF3.0_{NLO} PDF set and interfaced to PYTHIA 8.234 with the A14 tune. The samples are normalized to their respective NLO QCD cross-sections [70, 71] for the t-channel and s-channel, and with additional NNLL soft gluon terms for Wt production [72–74]. The diagram-removal scheme [75] was used in the generation of Wt events to address overlaps with the $t\bar{t}$ sample.

Signal samples for the pair production of T and B quarks were generated with PROTOS [76] interfaced with PYTHIA 8.186 using the NNPDF2.3_{LO} PDF set and the A14 tune. The samples were generated under the assumption that the coupling is small therefore the width of the VLQ is driven by the experimental resolution. The generated VLQ masses have widths typically smaller than 2% of the mass. Masses from 600 GeV to 2 TeV were simulated in the singlet model, but with the BR for each of the three decays to a vector or Higgs boson fixed to 1/3 for all samples. A BR reweighting procedure is performed event-by-event in order to achieve any BR configuration for a given VLQ mass, including the configurations expected for the doublet models. Dedicated signal samples in the doublet models for the 700 GeV and 1.2 TeV mass points were also produced to validate the reweighting procedure and to verify that the singlet and doublet signal kinematics are indistinguishable in the analysis as is assumed. The signal sample cross-sections were calculated with TOP++ at NNLO+NNLL in QCD using the MSTW2008_{NNLO} [77–79] PDF set.

4 Object reconstruction

Events are required to have at least one vertex candidate with at least two tracks with transverse momentum $p_T > 0.5$ GeV. The primary vertex (PV) is defined to be the candidate with the largest Σp_T^2 , where the sum is performed over all associated tracks.

Electrons are reconstructed [80] from clusters in the EM calorimeter matched with ID tracks and must fulfil the *tight likelihood* identification criteria. Electrons are calibrated and are required to have $p_T > 28$ GeV and to be reconstructed within $|\eta| < 2.47$, excluding the barrel–endcap transition regions ($1.37 < |\eta| < 1.52$). In order to maintain a high acceptance for the expected signal events, no isolation requirements are applied to electron candidates beyond those implicit in the trigger requirements. Furthermore, electron candidates must be associated with the PV by requiring that the longitudinal impact parameter with respect to the PV satisfies $|z_0 \cdot \sin \theta| < 0.5$ mm and that the transverse impact parameter with respect to the beamline (d_0) has a significance $|d_0|/\sigma(d_0) < 5$.

Muons are reconstructed [81] from combined tracks in the MS and the ID and must fulfil *medium* identification criteria. Muons are calibrated [82] and are required to have $p_T > 28$ GeV and to be reconstructed within $|\eta| < 2.5$. Muon candidates must also satisfy the track-based isolation requirements defined by the *FixedCutTightTrackOnly* working point. This working point uses the scalar sum of the p_T of all tracks that are within a cone of size $\Delta R = \min\{0.3, 10 \text{ GeV}/p_T(\mu)\}$ around the muon candidate, where $p_T(\mu)$ is the candidate muon p_T . The track associated with the muon candidate under consideration is excluded from the sum. The muon is selected if this sum is less than 15% of $p_T(\mu)$. Finally, muon candidates are required to have $|z_0 \cdot \sin \theta| < 0.5$ mm and a d_0 significance smaller than 3.

Jets are reconstructed using the anti- k_t algorithm [83, 84] with a radius parameter of 0.4 from topological clusters of energy deposits in the calorimeter [85, 86]. Jets are calibrated to an energy scale obtained from a combination of simulation-based corrections and measurements in data [87] and are required to fulfil $p_T > 25$ GeV for $|\eta| < 2.5$ and $p_T > 35$ GeV for $2.5 < |\eta| < 4.5$. To reduce jet contributions from pile-up, a ‘jet vertex tagger’ algorithm using a two-dimensional likelihood discriminant [88] is applied to jets with $|\eta| < 2.4$ and $p_T < 60$ GeV. The MV2c10 algorithm [89] is used to identify jets in the central region ($|\eta| < 2.5$) containing a b -hadron decay (b -tagging) with a working point corresponding to a b -tagging efficiency in simulated $t\bar{t}$ events of 77%, a c -jet rejection factor of ~ 6 , and a light-jet rejection factor of ~ 130 .

The missing transverse momentum [90], with magnitude E_T^{miss} , is defined as the negative vectorial sum of the transverse momenta of all the calibrated reconstructed lepton and jet candidates in the event and includes a ‘soft term’ with contributions from tracks emanating from the PV but not associated with any of the reconstructed objects.

A procedure to remove potential overlaps between reconstructed leptons and jets is performed sequentially as follows. First, any muon that leaves energy deposits in the calorimeters and shares a track in the ID with an electron is removed. After such muons have been removed, any electron sharing an ID track with one of the remaining muons is removed. Next, any jet within $\Delta R = 0.2$ of an electron is removed, followed by the removal of electrons within $\Delta R = 0.4$ of any remaining jet. Subsequently, any jet with at most two tracks with $p_T > 0.5$ GeV within $\Delta R = 0.2$ of a muon is removed, unless it has been b -tagged. At the end of the procedure, any muon within $\Delta R = \min\{0.4, 0.04 + 10 \text{ GeV}/p_T(\mu)\}$ of any remaining jet is removed.

Finally, large-radius ‘reclustered’ (RC) jets [91] are reconstructed by applying the anti- k_t algorithm with a radius parameter of 1.0, using the set of selected and already calibrated smaller-radius jets defined above. To reduce dependence on pile-up, the RC jets are trimmed [92] by removing all constituent jets with p_T below 5% of the RC jet p_T . These RC jets are used only for event categorization, and therefore no additional checks for potential overlaps with the previously defined objects are performed.

5 Event selection and categorization

An initial preselection of events is performed as follows. Events are required to satisfy at least one of the single-lepton triggers operating during Run 2 [38, 93, 94]. These triggers had varying p_T thresholds for electrons and muons for different data-taking periods, as well as isolation requirements that were typically more relaxed with increasing p_T threshold. For data collected in 2015, the thresholds are 24, 60, and 120 GeV for electrons and 20 and 50 GeV for muons. For the remainder of the dataset, the thresholds are slightly increased to 26, 60, and 140 GeV for electrons and to 26 and 50 GeV for muons. Events are additionally required to have at least two opposite-sign-charge, same-flavour (OS-SF) leptons and to have

at least two jets in the central region. The pair of OS-SF leptons with an invariant mass $m(\ell\ell)$ closest to $m_Z = 91.2$ GeV is referred to as ‘the Z boson candidate’ and only events with $|m(\ell\ell) - m_Z| < 10$ GeV are kept.

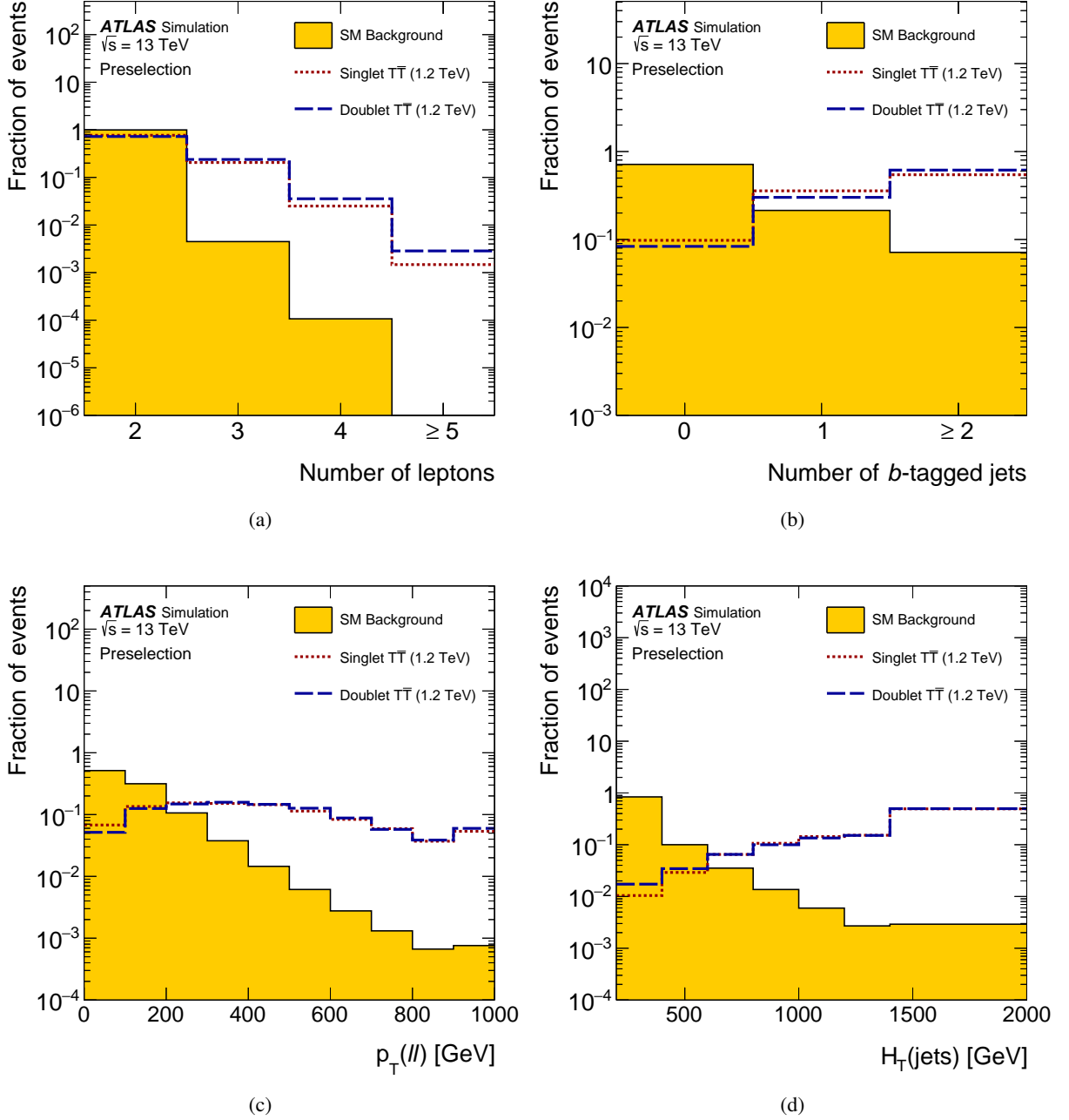

Figure 2: Distributions, normalized to unit area, obtained from MC simulation for the sum of all the background processes (solid area) and for benchmark signal processes (dashed lines): (a) lepton multiplicity, (b) b -tagged jet multiplicity, (c) transverse momentum of the Z boson candidate, $p_T(\ell\ell)$, and (d) scalar sum of the jet transverse momenta, $H_T(\text{jet})$. The signal processes concern the pair production of vector-like T or B quarks with a mass of 1.2 TeV in either the singlet or doublet configurations. The last bin contains the overflow.

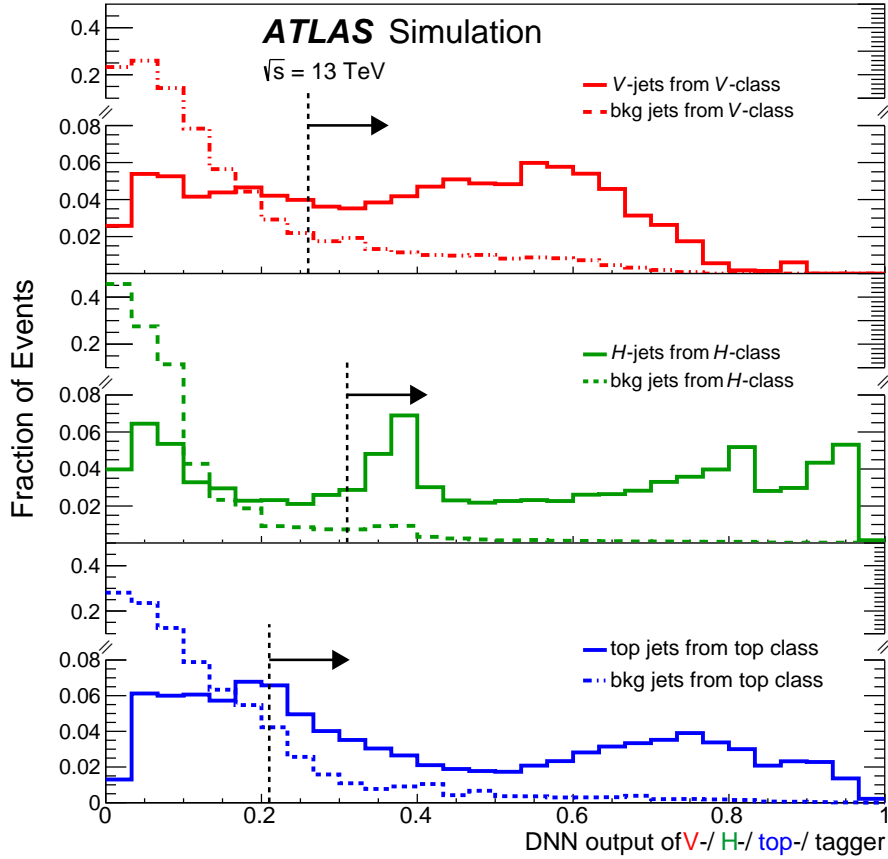

Figure 3: The distributions of the DNN output of MCBOT for the V boson, H boson, and top quark classes for RC jets with p_T between 150 GeV and 1 TeV. For each tagger (V , H , or top) the response to the corresponding signal jets (solid lines) is compared with the response to the background jets (dashed lines). The responses to signal jets other than the corresponding signal for each tagger are not shown for simplicity. Signal jets are defined by geometrically matching the RC jets to the corresponding generator-level particles. Background jets are obtained from multijet events. The colours red, green, and blue indicate the DNN output values for the V -, H -, or top-tagger, respectively. The RC jet p_T is reweighted together with the RC jet η to be uniform over the full range. All distributions are normalized to unit area. The y -axis is split for better readability.

Preselected events are divided into two orthogonal and individually optimized channels: one requiring exactly two leptons (dilepton, labelled as ‘ 2ℓ ’) and a second requiring at least three leptons (trilepton, labelled as ‘ 3ℓ ’). The channels are combined statistically to obtain the final result, taking advantage of the relatively high signal acceptance achieved by the 2ℓ channel and the higher signal purity offered by the 3ℓ channel.

Figure 2 shows distributions of example kinematic variables for the expected background and for benchmark signal processes obtained from MC simulation. In addition to the lepton multiplicity, the analysis exploits the high multiplicities of jets, large-radius jets, and b -tagged jets expected for pair-produced VLQ signal. Requirements on the momentum of the Z boson candidate, $p_T(\ell\ell)$, and the scalar sums of the transverse momenta of objects reconstructed in the events, H_T , are applied to suppress the background. Furthermore, the analysis uses RC jets as an input to a ‘multi-class boosted object tagger’ (MCBOT) in order to identify (tag) the origin of each RC jet as being either a hadronically decaying V boson, H boson, or top quark.

MCBOT is based on a multi-class DNN using the Keras [95] and TensorFlow [96] software libraries. The DNN is trained using RC jets from simulated $Z' \rightarrow t\bar{t}$ events, $W' \rightarrow WZ$ events, and events with a Kaluza–Klein graviton in the bulk Randall–Sundrum model [97] decaying into a pair of H bosons which each decay into $b\bar{b}$ with a BR fixed to 100%. These dedicated events are generated so that RC jets with a mass of at least 40 GeV are uniformly distributed in an RC jet p_T range between 150 GeV and 3 TeV. The three signal labels (V , H , top) are assigned by matching the RC jet to the corresponding hadronically decaying boson or top quark within a ΔR of 0.75 at generator level. Simulated multijet events are used to obtain the RC jets with a *background* label. The RC jets in these four classes are reweighted such that their distributions are uniform in RC jet p_T and η . The 18 input variables of the DNN are the RC jet p_T and mass, the number of the RC jet constituent smaller-radius jets, the four-momentum vectors of the three highest- p_T constituent jets, and the b -tagging decisions for those three jets. The DNN consists of four fully connected hidden layers with *Rectified Linear Unit* [98] activation functions and a four-dimensional output layer in which nodes are activated using the *softmax* [99] function. The first hidden layer uses 32 nodes, reduced to 27, 14, and 12 nodes for the second, third, and fourth hidden layer, respectively. The ADAM [100] optimizer is used to minimize the categorical cross-entropy as a loss function in order to find the optimal weights. The set of hyper-parameters as optimized for a related ATLAS analysis [14] is used. The projections of the four-dimensional output of the DNN are used to define a working point for each of the signals in order to define a V -tag, a H -tag, and a top-tag. Figure 3 shows an example set of these projections for RC jets with p_T between 150 GeV and 1 TeV. In cases where the same RC jet satisfies the requirements for more than one tag, the tag with the highest neural-network output value is retained. Therefore, at most one signal label can be assigned to any RC jet. For the selected working point, and for $T\bar{T}$ signal with $m_T = 1400$ GeV in the singlet configuration, efficiencies of 55%, 41%, and 54% are measured for V , H , and top signals, respectively.

In the 2ℓ channel, events are required to satisfy $p_T(\ell\ell) > 300$ GeV in order to select leptonic Z boson candidates originating from the decay of a heavy VLQ. In addition, given the large amount of jet activity expected in signal events and to take advantage of a potentially invisible decay of the Z boson in the decay chain of the second VLQ in the pair, requirements are placed on the scalar sum of the jet transverse momenta, $H_T(\text{jet})$, and E_T^{miss} . Two exclusive signal regions (SR) are defined by requiring $H_T(\text{jet}) + E_T^{\text{miss}} > 1380$ GeV and either exactly one b -tagged jet ($1b$ SR) or at least two b -tagged jets ($2b$ SR). The chosen kinematic requirements are motivated by the selection criteria of the earlier ATLAS analysis [13] and are optimized using a procedure that maximizes the expected sensitivity for a few benchmark signal models. The most relevant event selection criteria are shown in Table 1, which additionally shows the definitions of the signal regions and background control regions. The events in each SR are divided into exclusive categories based on combinations of the numbers of signal-tagged RC jets of various types identified by MCBOT. A signal significance optimization procedure is used to group the possible tagging combinations so as to reduce the set of categories to seven, as shown in Table 2. These include ‘Double tag’ categories with different combinations of at least two RC jets with tags of any signal type, as well as a final ‘Overflow’ category that includes events with more than two tags but also leftover two-tag combinations that are not included in the former categories. In order to recover some of the events in which RC jets might be misidentified, combinations with more than one V or H boson are included even though one of the two VLQs is required to decay to a leptonically decaying Z boson in the targeted event topology.

In the 3ℓ channel, the Z candidate transverse momentum requirement is relaxed to $p_T(\ell\ell) > 200$ GeV to increase signal efficiency given the significant background suppression due to the three-lepton requirement. To take advantage of the additional lepton activity, events must also satisfy $H_T(\text{jet} + \text{lep}) > 300$ GeV, where $H_T(\text{jet} + \text{lep})$ is the scalar sum of the jet and lepton transverse momenta. Events in the 3ℓ SR are

Table 1: Definitions of analysis regions and the most relevant event selection criteria. The final discriminating variables used in the fit are also indicated for each region: $m(Zb_1)$ and $m(Zb_2)$ refer to the mass of the system of the Z boson candidate and either the leading b -jet or subleading b -jet, respectively. $H_T(\text{jet})$ is defined as the scalar sum of the transverse momenta of all selected jets, while $H_T(\text{jet} + \text{lep})$ is defined as the scalar sum of the transverse momenta of all selected jets and leptons.

Preselection	≥ 2 central jets at least two SF leptons with $p_T > 28$ GeV at least one pair of OS-SF leptons $ m(\ell\ell) - m_Z < 10$ GeV					
Channel definitions	2ℓ $= 2\ell$ $p_T(\ell\ell) > 300$ GeV $H_T(\text{jet}) + E_T^{\text{miss}} > 920$ GeV				3ℓ $\geq 3\ell$ $p_T(\ell\ell) > 200$ GeV $H_T(\text{jet} + \text{lep}) > 300$ GeV	
Region definitions	$1b$ SR $H_T(\text{jet}) + E_T^{\text{miss}} > 1380$ GeV $= 1$ b -jet	$2b$ SR $H_T(\text{jet}) + E_T^{\text{miss}} > 1380$ GeV ≥ 2 b -jet	$1b$ CR $H_T(\text{jet}) + E_T^{\text{miss}} < 1380$ GeV $= 1$ b -jet	$2b$ CR $H_T(\text{jet}) + E_T^{\text{miss}} < 1380$ GeV ≥ 2 b -jet	SR ≥ 1 b -jet	VV CR $= 0$ b -jet
MCBOT categories	7	7	–	–	5	–
Fitted variable	$m(Zb_1)$	$m(Zb_2)$	$H_T(\text{jet}) + E_T^{\text{miss}}$		$H_T(\text{jet} + \text{lep})$	

also required to have at least one b -tagged jet and are divided into five exclusive categories based on the number of MCBOT tags, similarly to the 2ℓ channel, as shown in Table 2.

The signal efficiency, defined as the ratio of the number of events selected by the signal regions to the number of events generated in the signal samples, for the benchmark of a 1.2 TeV singlet T , is 0.3% and 0.5% in the $1b$ and $2b$ 2ℓ signal regions, respectively, and 0.5% in the 3ℓ signal regions.

The SM background contribution is estimated using MC simulation and is adjusted in the final simultaneous maximum-likelihood fit to the data with the help of signal-depleted control regions (CR), designed to be similar in phase-space to the SR. Leading backgrounds include Z +jets, which is the dominant background for 2ℓ , as well as VV and $t\bar{t} + X$, which are dominant for 3ℓ . Smaller backgrounds include those from $t\bar{t}$, single top quark and four top quark.

The inputs to the fit are binned distributions of final discriminants optimized for each of the two channels. In the 2ℓ channel, in all the $1b$ SR categories, the invariant mass of the leptonically decaying Z candidate and the leading b -tagged jet, $m(Zb_1)$, is used as a final discriminant, while for the $2b$ SR categories the subleading b -tagged jet is used instead and the discriminating variable is $m(Zb_2)$. Two 2ℓ CR corresponding to each SR are defined by requiring $920 \text{ GeV} < H_T(\text{jet}) + E_T^{\text{miss}} < 1380 \text{ GeV}$. These CR are not further categorized using MCBOT and participate in the fit using the distribution of $H_T(\text{jet}) + E_T^{\text{miss}}$. In the 3ℓ channel a single VV CR is defined by requiring exactly zero b -jets. The final discriminant for all 3ℓ SR categories and for the VV CR is $H_T(\text{jet} + \text{lep})$.

6 Systematic uncertainties

Several experimental and theoretical systematic uncertainties that can affect the normalization or the shape of the fitted distributions are considered. For each considered source of uncertainty, variations representing the -1σ and $+1\sigma$ confidence interval are derived. The analysis selection, including the

Table 2: Definitions of the categorization of events in the 2ℓ and 3ℓ channels based on the number of MCBOT tags. Unless otherwise noted, the columns indicate the exact number of required tagged RC jets for each type. Categories labelled as ‘Double tag’ include combinations with exactly two tags of any type. Categories labelled as ‘Overflow (OF)’ include all the tagging combinations that are not explicitly included in the other categories.

Category	2ℓ channel						3ℓ channel		
	$1b$ SR			$2b$ SR			–		
	V-tags	H-tags	top-tags	V-tags	H-tags	top-tags	V-tags	H-tags	top-tags
No tag	0	0	0	0	0	0	0	0	0
V tag	1	0	0	1	0	0	≥ 1	0	0
H tag	0	1	0	0	1	0	0	≥ 1	0
Top tag	0	0	1	0	0	1	0	0	≥ 1
Double tag 1	2	0	0	2	0	0		–	
	0	2	0	0	2	0		–	
	1	0	1	1	1	0		–	
		–		0	0	2		–	
Double tag 2	0	1	1	0	1	1		–	
	0	0	2		–			–	
Overflow (OF)	1	1	0	1	0	1	0	≥ 1	≥ 1
		or > 2 tags			or > 2 tags		≥ 1	0	≥ 1
		–			–		≥ 1	≥ 1	0
		–			–		≥ 1	≥ 1	≥ 1

MCBOT categorization, is applied on each variation to estimate their effect on the final discriminants. Several of these modelling uncertainties are constrained after the fit due to the significantly larger number of events in the control regions compared to the signal regions. However, these constraints do not impact the final limit. Furthermore, the analysis is dominated by statistical uncertainties; the expected lower limits on the VLQ masses decrease by no more than 4% when all the systematic uncertainties are included in the analysis.

Experimental uncertainties include effects on the electron energy scale and energy resolution [80], the muon momentum scale and resolution [81], as well as uncertainties in the data-to-MC correction factors for the electron and muon trigger, reconstruction, identification, and isolation efficiencies [80, 81]. Jet energy scale and resolution uncertainties are also included, as obtained from studies in data and simulation [87]. A 10% uncertainty [101] is assigned to the small-radius jet mass, which is not calibrated but is used in the RC jet mass calculation. Flavour-tagging uncertainties include uncertainties in the b -jet tagging, c -jet tagging, and light-jet mis-tagging efficiencies, and uncertainties due to extrapolations to regions not covered by the data used for the efficiency measurements [89, 102, 103]. Subdominant uncertainties include uncertainties related to the soft term in the E_T^{miss} calculation [90] and to the E_T^{miss} energy scale and resolution, uncertainties in the reweighting of the MC event samples to match the pile-up conditions in data, and a 1.7% [104] uncertainty in the integrated luminosity of the combined 2015–2018 dataset.

Theoretical uncertainties include cross-section and other modelling uncertainties for all background samples. The cross-section uncertainties considered are of order 5% to 6% for the Z +jets, $t\bar{t}$, and VV

samples [105, 106] and of order 10% [105] $t\bar{t} + Z$ samples. A conservative 50% uncertainty is used for the $t\bar{t} + W$ sample. Uncertainties due to the choice of generator or showering algorithm are estimated using additional samples from alternative generators. The uncertainties due to the choice of factorization and renormalization scales, the modelling of ISR and FSR, and the choice of PDF set are estimated by varying the nominal sample via additional generator weights, if available, or by using alternative samples. An additional shape uncertainty is applied to the modelling of the heavy-flavour fraction (HF) of jets in the Z +jets and VV samples. This uncertainty is estimated by separating, using generator-level information, the events with jets originating from b or c quarks from events with jets originating from light quarks and rescaling the HF contribution by 50%. In the 2ℓ channel, the HF uncertainty is uncorrelated between the categories requiring exactly one or at least two b -tagged jets. In the 3ℓ channel, the HF uncertainty is applied in a correlated way across the SR categories and the VV CR, since both regions have the same b -tagging requirements. Uncertainties in the VLQ pair-production cross-section similarly include the independent variation of the factorization and renormalization scales and variations in the PDF and strong coupling constant, following the PDF4LHC [107] prescription with the MSTW 2008 68% CL NNLO, CT10 NNLO [108, 109] and NNPDF2.3 5f FFN PDF sets.

7 Results

The compatibility of the data with the background-only hypothesis or with the signal-plus-background hypothesis is tested with a binned likelihood fit of the discriminating variables in the categories of each individual channel. The uncertainties are included as nuisance parameters (NP) with Gaussian constraints in the likelihood fit. Additional NPs are included to take into account the statistical uncertainties in each bin for each event category due to the limited size of the simulated samples. The likelihood function $L(\mu, \vec{\theta})$ is constructed as a product of Poisson probabilities for each bin in the discriminating variable in each category and depends on the signal-strength factor μ , which multiplies the expected signal cross-section σ , and the set of all NPs $\vec{\theta}$. Test statistics are based on the profile-likelihood ratio $\lambda_\mu = L(\mu, \hat{\vec{\theta}}_\mu) / L(\hat{\mu}, \hat{\vec{\theta}}_\mu)$ where $\hat{\mu}$ and $\hat{\vec{\theta}}_\mu$ are the values of μ and $\vec{\theta}$ that maximize the likelihood function, and $\hat{\vec{\theta}}_\mu$ are the values of $\vec{\theta}$ that maximize the likelihood for a given μ [110]. Hypothesis tests are performed with RooStats [111] with statistical models implemented using RooFit [112] and HistFactory [113]. The fit procedure was first validated in pseudo-data obtained by the sum of the expected background contributions. Subsequently, the procedure and the modelling of the background were tested by including in the fit those categories in which the benchmark signal contribution is expected to be smaller than 3% of the total background. Before the final full unblinding of the data, an additional check was performed by including in the fit all bins in all analysis categories with expected signal contributions smaller than 5% of the total background in those bins.

A background-only fit to the data, in which μ is set to zero, is performed using q_0 [110] as the test statistic and no significant excess over the background expectation is observed. To obtain the final result, a simultaneous fit of all the regions and categories of both channels is performed. The results are found to be insensitive to variations of the correlation model and the following approach was adopted: all experimental and cross-section uncertainties are treated as fully correlated between the two analysis channels, while the remaining, modelling-related, uncertainties are treated as uncorrelated. Figure 4 shows the background and observed data yields in all the analysis categories after the combined background-only fit (post-fit). Post-fit distributions of the fitted variables in the background control regions and in selected signal region categories are shown in Figure 5 for the 2ℓ channel and in Figure 6 for the 3ℓ channel. The figures include

the expected distributions for $T\bar{T}$ signal with $m_T = 1.2$ TeV generated in the singlet configuration. The event yields for the dominant backgrounds in each event category after the background-only fit are also summarized in Table 3, which includes the number of events observed in data. The table also includes the expected yields in number of events for $T\bar{T}$ and $B\bar{B}$ production in the singlet configuration with $m_{\text{VLQ}} = 1.2$ TeV. These yields and their uncertainties are provided before any fit is performed (pre-fit).

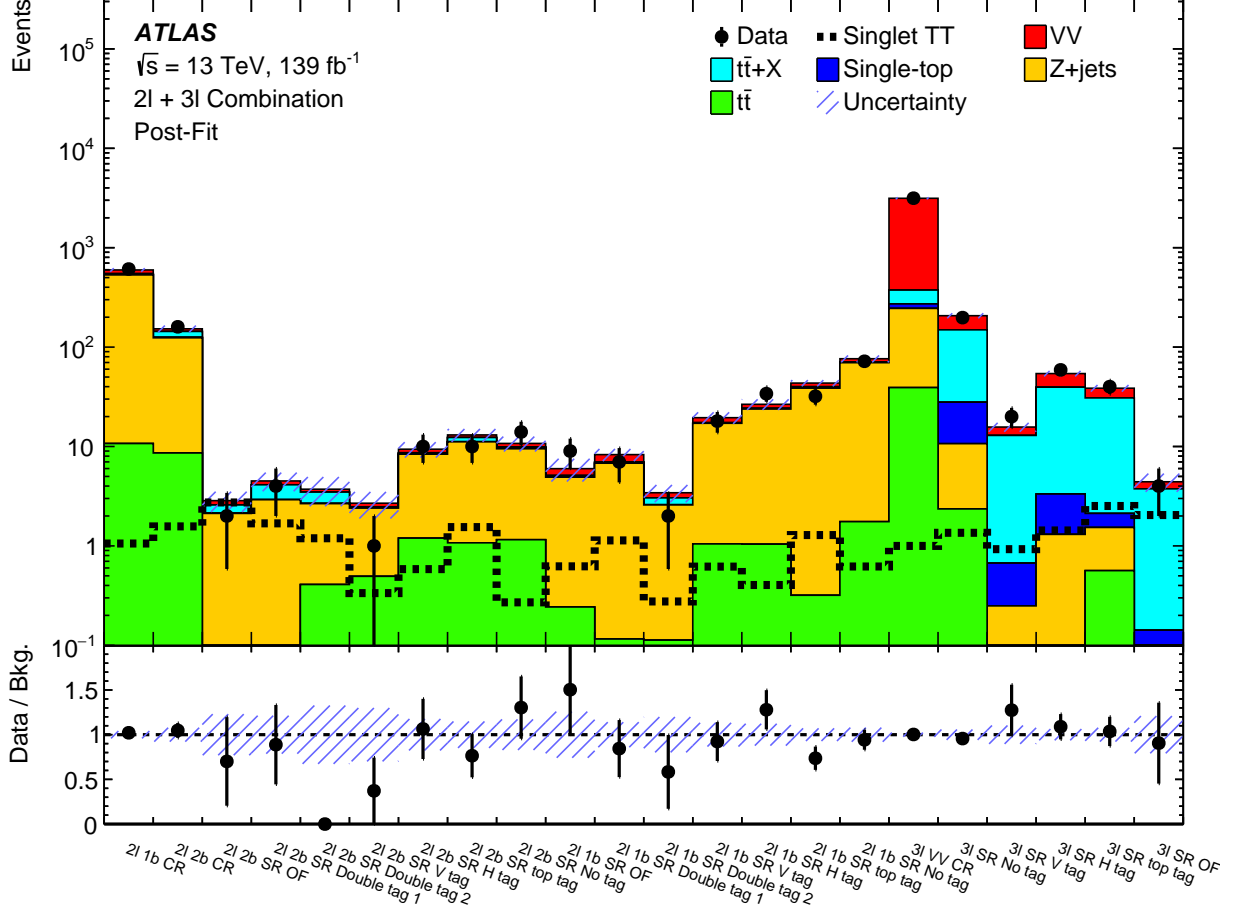

Figure 4: Summary of data and background yields in all analysis categories after the background-only fit. The expected yields for singlet $T\bar{T}$ signal with $m_T = 1.2$ TeV are also shown for comparison. The bottom panel shows the ratio of the data over the total background prediction. The shaded band includes statistical and post-fit systematic uncertainties.

Upper limits on the pair-production cross-section as a function of the VLQ mass are derived at 95% CL for the T and B quarks. These limits are derived by using \tilde{q}_μ [110] as the test statistic with the CL_s technique [114, 115] in the asymptotic approximation [110]. The limits are found to agree within a few percent with the limits obtained with pseudo-experiments. For the 1σ uncertainty contours, the limits agree within 10%, with the -1σ band being slightly too narrow in the asymptotic approximation and the $+1\sigma$ band being slightly too wide. The expected and observed upper limits on the cross-section obtained from the combination of the two channels are shown in Figure 7. To demonstrate the complementarity of the two channels, their individually obtained expected limits are also shown. Three benchmark scenarios for each of B and T are shown, namely the singlet, doublet, and 100% BR configurations, with increasingly high BR to Zb or Zt . Comparisons with the respective theoretical predictions of the cross-sections give

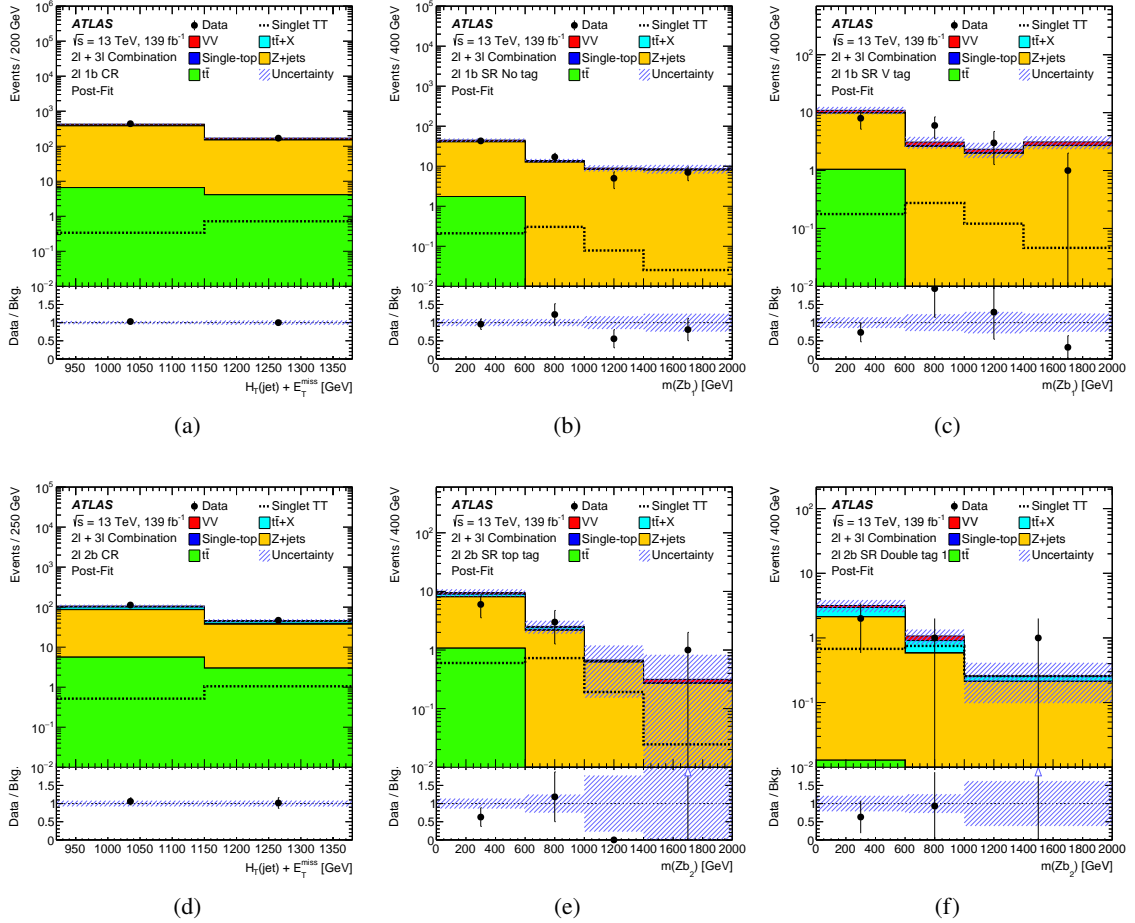

Figure 5: Distributions of the final discriminants for the 2ℓ channel in the control regions and in selected event categories of the signal regions: (a) control region and (b,c) categories requiring exactly one b -jet or (d) control region and (e,f) categories requiring at least two b -jets. The distributions are shown after the combined background-only fit. The distributions expected for singlet $T\bar{T}$ signal with $m_T = 1.2$ TeV are also shown in overlay. The bottom panels show the ratio of the data over the total background prediction. The two blue triangles indicate points beyond the vertical range. The last bin contains the overflow.

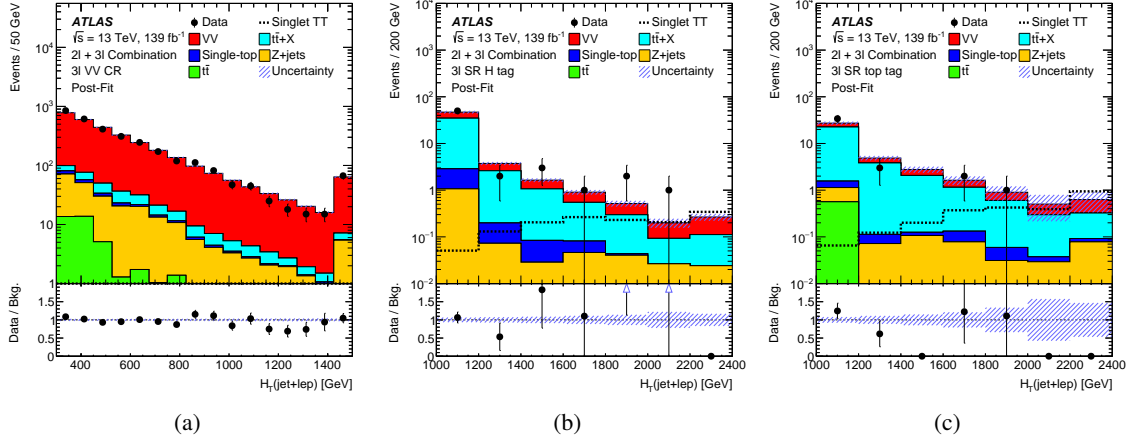

Figure 6: Distributions of the final discriminants for the 3ℓ channel in the (a) VV control region and in (b,c) selected event categories of the signal region. The distributions are shown after the combined background-only fit. The distributions expected for singlet $T\bar{T}$ signal with $m_T = 1.2$ TeV are also shown in overlay. The bottom panels show the ratio of the data over the total background prediction. The two blue triangles indicate points beyond the vertical range. The last bin contains the overflow.

Table 3: Summary of observed and predicted yields in the control regions and signal region categories. The background prediction is shown after the combined likelihood fit to data under the background-only hypothesis across all control region and signal region categories. The uncertainties include statistical and systematic uncertainties. Due to correlations, the total background uncertainty is not necessarily equal to the sum in quadrature of the uncertainties of the individual background processes. The expected yields for benchmark signals with $m_{\text{VLQ}} = 1.2$ TeV obtained by using their theoretical cross-sections are also shown with their pre-fit uncertainties. Dashes indicate negligible yields.

Event category	Data	Total background							Singlet $T\bar{T}$	
			VV	$t\bar{t} + X$	Single-top	Z+jets	$t\bar{t}$	$m_T = 1.2$ TeV	Singlet $B\bar{B}$ $m_B = 1.2$ TeV	
$2\ell 1b$ CR	610	598 ± 24	50 ± 18	13 ± 4	1.3 ± 0.6	522 ± 30	11 ± 4	1.06 ± 0.08	1.27 ± 0.09	
$2\ell 1b$ SR No tag	72	76 ± 6	5.5 ± 2.0	0.37 ± 0.13	0.8 ± 0.9	68 ± 6	1.8 ± 1.9	0.62 ± 0.13	1.52 ± 0.23	
$2\ell 1b$ SR V tag	18	19.6 ± 2.6	2.2 ± 0.8	0.22 ± 0.08	–	16.1 ± 2.1	1.1 ± 1.3	0.63 ± 0.07	1.31 ± 0.13	
$2\ell 1b$ SR H tag	34	26.6 ± 3.3	2.4 ± 0.9	0.38 ± 0.09	–	22.8 ± 3.0	1.1 ± 1.5	0.41 ± 0.05	0.66 ± 0.09	
$2\ell 1b$ SR top tag	32	43.5 ± 3.1	3.6 ± 1.3	1.25 ± 0.22	–	38.3 ± 3.3	0.3 ± 0.6	1.29 ± 0.14	1.40 ± 0.14	
$2\ell 1b$ SR Double tag 1	7	8.3 ± 1.2	1.3 ± 0.5	0.20 ± 0.09	–	6.7 ± 1.0	0.1 ± 0.4	1.14 ± 0.15	1.05 ± 0.17	
$2\ell 1b$ SR Double tag 2	2	3.4 ± 0.7	0.39 ± 0.19	0.42 ± 0.10	–	2.5 ± 0.5	0.11 ± 0.31	0.27 ± 0.06	0.19 ± 0.06	
$2\ell 1b$ SR OF	9	6.0 ± 1.6	0.9 ± 0.4	0.18 ± 0.05	–	4.7 ± 1.3	0.2 ± 0.7	0.62 ± 0.08	0.60 ± 0.11	
$2\ell 2b$ CR	160	152 ± 12	9 ± 4	18 ± 6	1.2 ± 0.6	115 ± 13	9.0 ± 3.5	1.58 ± 0.10	1.90 ± 0.13	
$2\ell 2b$ SR No tag	14	10.7 ± 1.9	0.9 ± 0.4	0.07 ± 0.08	0.3 ± 0.5	8.3 ± 1.1	1.2 ± 1.4	0.27 ± 0.07	1.11 ± 0.17	
$2\ell 2b$ SR V tag	1	2.7 ± 0.8	0.22 ± 0.13	0.06 ± 0.05	–	1.9 ± 0.5	0.5 ± 0.7	0.34 ± 0.04	0.81 ± 0.08	
$2\ell 2b$ SR H tag	10	9.4 ± 1.6	0.76 ± 0.34	0.26 ± 0.09	–	7.1 ± 1.0	1.2 ± 1.4	0.59 ± 0.09	1.90 ± 0.16	
$2\ell 2b$ SR top tag	10	13.0 ± 1.9	0.8 ± 0.4	1.10 ± 0.30	–	10.0 ± 1.6	1.1 ± 1.2	1.56 ± 0.18	1.97 ± 0.15	
$2\ell 2b$ SR Double tag 1	4	4.5 ± 1.0	0.40 ± 0.25	1.2 ± 0.6	–	2.9 ± 0.8	0.01 ± 0.19	1.71 ± 0.11	1.71 ± 0.18	
$2\ell 2b$ SR Double tag 2	0	3.7 ± 1.2	0.25 ± 0.14	0.78 ± 0.18	–	2.3 ± 0.6	0.4 ± 1.1	1.22 ± 0.10	1.12 ± 0.10	
$2\ell 2b$ SR OF	2	2.8 ± 0.7	0.28 ± 0.15	0.44 ± 0.20	–	2.1 ± 0.6	–	2.76 ± 0.25	2.02 ± 0.26	
$3\ell VV$ CR	3149	3140 ± 70	2770 ± 90	98 ± 9	26.7 ± 1.6	210 ± 60	40 ± 18	1.00 ± 0.14	0.90 ± 0.14	
$3\ell SR$ No tag	198	203 ± 11	59 ± 5	117 ± 10	17.3 ± 0.6	8.5 ± 3.0	2.4 ± 2.0	1.37 ± 0.17	1.31 ± 0.17	
$3\ell SR$ V tag	20	15.3 ± 1.5	2.82 ± 0.34	11.8 ± 1.5	0.42 ± 0.06	0.25 ± 0.11	–	0.94 ± 0.07	0.71 ± 0.09	
$3\ell SR$ H tag	59	52.9 ± 2.8	14.9 ± 1.2	34.7 ± 2.7	2.03 ± 0.14	1.3 ± 0.4	–	1.44 ± 0.10	0.96 ± 0.08	
$3\ell SR$ top tag	40	37.7 ± 2.6	7.9 ± 0.6	27.6 ± 2.4	0.59 ± 0.07	1.0 ± 0.4	0.6 ± 1.2	2.54 ± 0.16	1.73 ± 0.12	
$3\ell SR$ OF	4	4.3 ± 0.9	0.68 ± 0.11	3.4 ± 0.8	0.07 ± 0.03	0.07 ± 0.05	–	2.07 ± 0.16	0.69 ± 0.13	

the lowest-allowed VLQ masses as summarized in Table 4. The higher signal purity in the 3ℓ channel results in an overall higher sensitivity for T than in the 2ℓ channel, while the larger data sample and finer categorization of the latter manifests in a performance that is dominant in the results for B . For models with 100% BR to the Z boson and a third-generation quark, T (B) masses up to 1.60 TeV (1.42 TeV) are excluded at 95% CL, while for the singlet and doublet configurations, masses are excluded up to 1.27 TeV (1.20 TeV) and up to 1.27 TeV (1.32 TeV), respectively. The combination of the two channels with their fine categorization results in the observed sensitivity, however, the limits are evidently driven by the categories with high expected signal-to-background fractions, namely, ‘2l 2b SR OF’ (100%) and ‘3l SR OF’ (45%).

Intermediate BR configurations are obtained by reweighting the simulated signal events to any target BR composition using generator-level information and assuming a total BR of 100% for the $T \rightarrow Zt$, $T \rightarrow Wb$, and $T \rightarrow Ht$ decay modes or the $B \rightarrow Zb$, $B \rightarrow Wt$, and $B \rightarrow Hb$ decay modes. The reweighting procedure allows 95% CL upper limits on the production cross-section to be set across the BR plane for each considered VLQ mass. By comparison with the theoretical prediction, lower limits on the T and B masses as a function of the BR composition can be obtained, as shown in Figure 8. As can be seen, the analysis is sensitive to a large subset of the possible BR compositions but the limits are more stringent closer to the lower-left corner of the BR plane, and thus for a higher BR for VLQ decays to a Z boson.

Table 4: Observed (expected) mass limits in TeV for the T and B singlet, doublet, and models with 100% BR to Z for the two channels and their combination.

Model	Observed (Expected) Mass Limits [TeV]		
	2ℓ	3ℓ	Combination
$T\bar{T}$ Singlet	1.14 (1.16)	1.22 (1.21)	1.27 (1.28)
$T\bar{T}$ Doublet	1.34 (1.32)	1.38 (1.37)	1.46 (1.44)
100% $T \rightarrow Zt$	1.43 (1.43)	1.54 (1.50)	1.60 (1.56)
$B\bar{B}$ Singlet	1.14 (1.21)	1.11 (1.10)	1.20 (1.25)
$B\bar{B}$ Doublet	1.31 (1.37)	1.07 (1.04)	1.32 (1.38)
100% $B \rightarrow Zb$	1.40 (1.47)	1.16 (1.18)	1.42 (1.48)

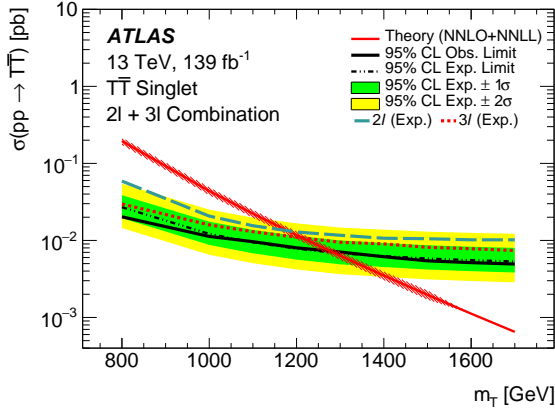

(a)

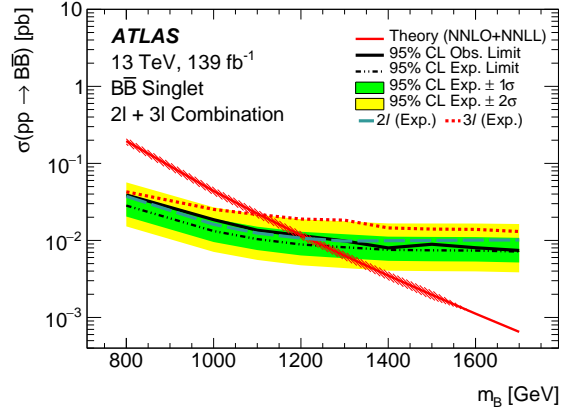

(b)

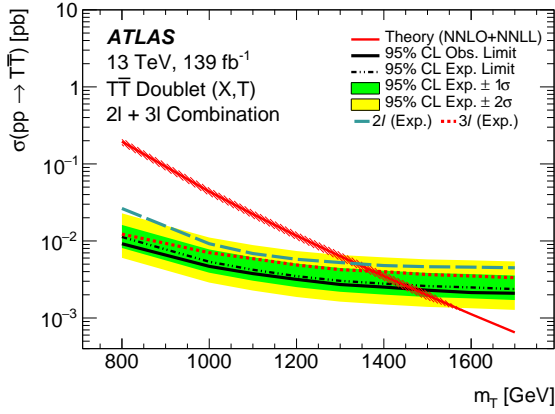

(c)

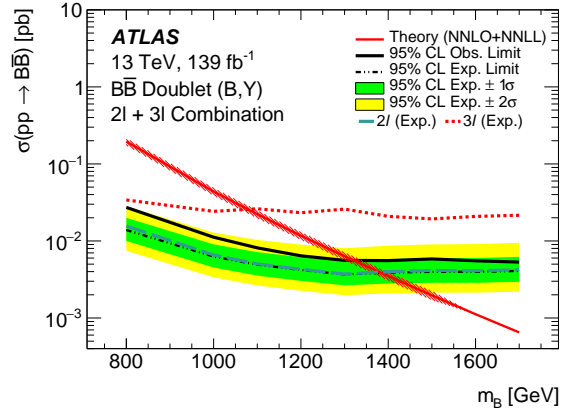

(d)

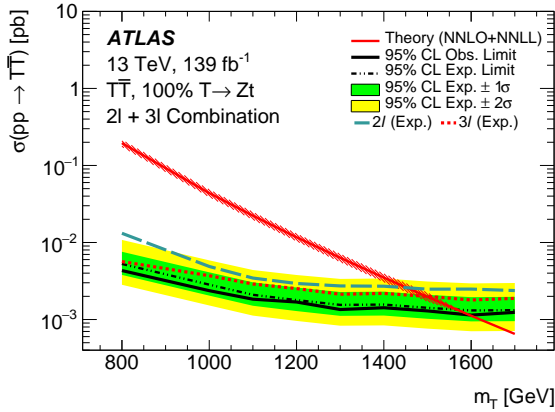

(e)

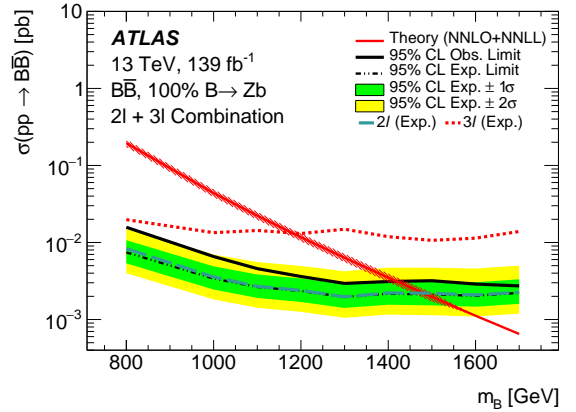

(f)

Figure 7: Expected and observed combined limits at 95% CL on the production cross-section for (a,c, and e) $T\bar{T}$ and (b,d, and f) $B\bar{B}$ for three representative BR compositions. The expected limits for the two individual channels are also shown.

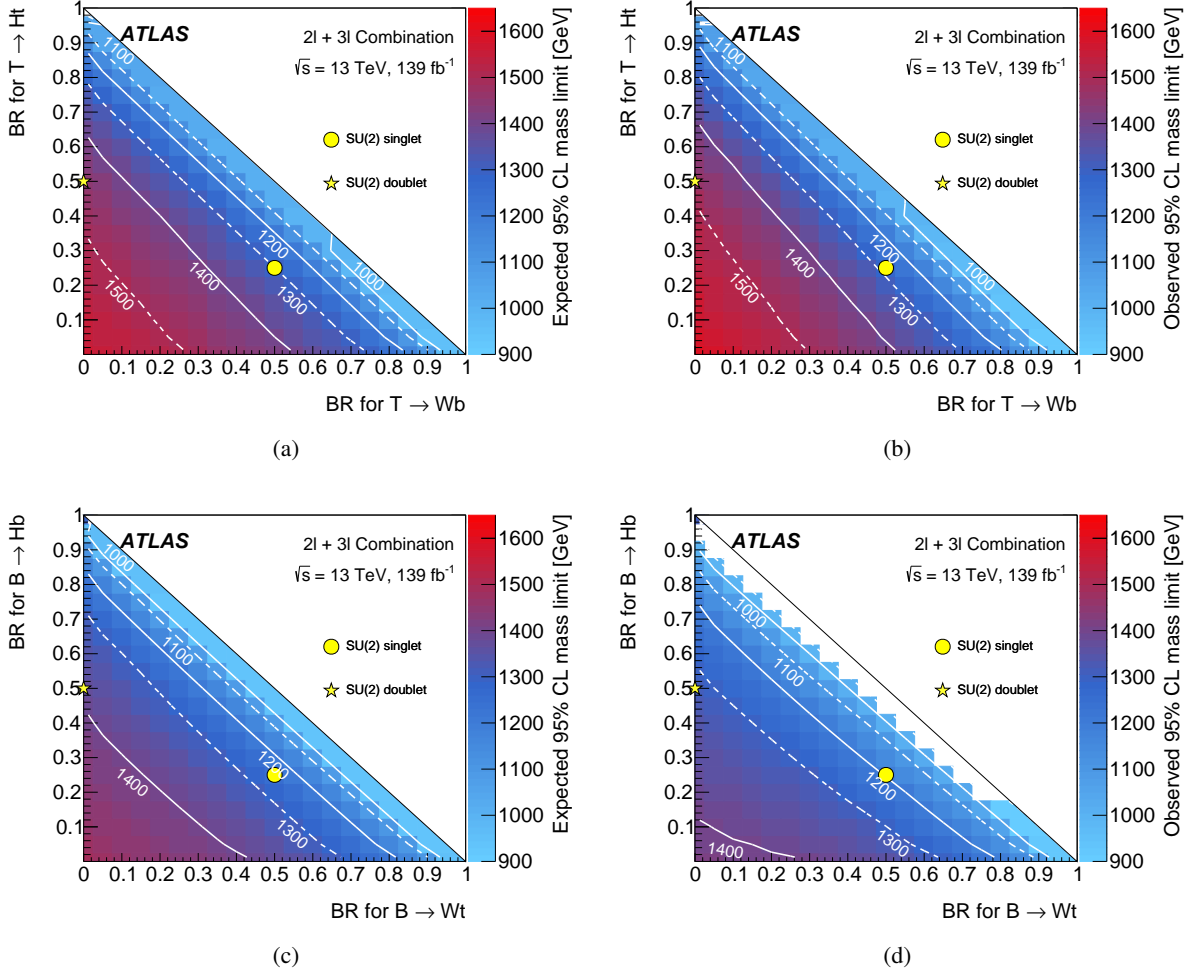

Figure 8: The (a,c) expected and (b,d) observed lower limits on the T and B masses at 95% CL in the BR plane from the combination of the two analysis channels for the production of (a,b) $T\bar{T}$ and (c,d) $B\bar{B}$, for all BR configurations when assuming a total BR of 100% for $T \rightarrow Zt$, $T \rightarrow Wb$, and $T \rightarrow Ht$ decays or $B \rightarrow Zb$, $B \rightarrow Wt$, and $B \rightarrow Hb$ decays, respectively. The white lines represent the contours of fixed m_{VLQ} .

8 Conclusions

A search for the pair production of vector-like quarks T or B , with electric charges $(2/3)e$ and $-(1/3)e$, respectively, is presented in which at least one of the VLQs decays into a leptonically decaying Z boson and a third-generation quark. Two orthogonal channels based on the number of selected leptons are separately optimized and their results are statistically combined to obtain the final result. In both channels a multi-class boosted object tagger for large-radius jets reclustered from smaller-radius jets is used to categorize events according to the numbers of V -tags, H -tags, and top-tags. The expected SM background is modelled with MC simulation and a maximum-likelihood fit to the data is performed. No significant excess over the background expectation is observed, and therefore 95% CL upper limits on the T and B pair-production cross-sections are derived.

The combined results exclude T (B) masses up to 1.27 TeV and 1.46 TeV (up to 1.20 TeV and 1.32 TeV) for the singlet and doublet configurations, respectively. For the doublet configuration, the lower limits on the T mass are extended by 90 GeV compared to the most stringent previous ATLAS results, while the limits on the excluded T and B masses are extended by more than 200 GeV compared to the earlier ATLAS analysis using a subset of the Run 2 data. Finally, for exclusive VLQ decays to the Z boson and a third-generation quark, this search marginally extends the limits on the T and B masses to obtain the most stringent limits to date.

Acknowledgements

We thank CERN for the very successful operation of the LHC, as well as the support staff from our institutions without whom ATLAS could not be operated efficiently.

We acknowledge the support of ANPCyT, Argentina; YerPhI, Armenia; ARC, Australia; BMWFW and FWF, Austria; ANAS, Azerbaijan; CNPq and FAPESP, Brazil; NSERC, NRC and CFI, Canada; CERN; ANID, Chile; CAS, MOST and NSFC, China; Minciencias, Colombia; MEYS CR, Czech Republic; DNRF and DNSRC, Denmark; IN2P3-CNRS and CEA-DRF/IRFU, France; SRNSFG, Georgia; BMBF, HGF and MPG, Germany; GSRI, Greece; RGC and Hong Kong SAR, China; ISF and Benoziyo Center, Israel; INFN, Italy; MEXT and JSPS, Japan; CNRST, Morocco; NWO, Netherlands; RCN, Norway; MEiN, Poland; FCT, Portugal; MNE/IFA, Romania; MESTD, Serbia; MSSR, Slovakia; ARRS and MIZŠ, Slovenia; DSI/NRF, South Africa; MICINN, Spain; SRC and Wallenberg Foundation, Sweden; SERI, SNSF and Cantons of Bern and Geneva, Switzerland; MOST, Taiwan; TENMAK, Türkiye; STFC, United Kingdom; DOE and NSF, United States of America. In addition, individual groups and members have received support from BCKDF, CANARIE, Compute Canada and CRC, Canada; PRIMUS 21/SCI/017 and UNCE SCI/013, Czech Republic; COST, ERC, ERDF, Horizon 2020 and Marie Skłodowska-Curie Actions, European Union; Investissements d’Avenir Labex, Investissements d’Avenir Idex and ANR, France; DFG and AvH Foundation, Germany; Herakleitos, Thales and Aristeia programmes co-financed by EU-ESF and the Greek NSRF, Greece; BSF-NSF and MINERVA, Israel; Norwegian Financial Mechanism 2014–2021, Norway; NCN and NAWA, Poland; La Caixa Banking Foundation, CERCA Programme Generalitat de Catalunya and PROMETEO and GenT Programmes Generalitat Valenciana, Spain; Göran Gustafssons Stiftelse, Sweden; The Royal Society and Leverhulme Trust, United Kingdom.

The crucial computing support from all WLCG partners is acknowledged gratefully, in particular from CERN, the ATLAS Tier-1 facilities at TRIUMF (Canada), NDGF (Denmark, Norway, Sweden), CC-IN2P3

(France), KIT/GridKA (Germany), INFN-CNAF (Italy), NL-T1 (Netherlands), PIC (Spain), ASGC (Taiwan), RAL (UK) and BNL (USA), the Tier-2 facilities worldwide and large non-WLCG resource providers. Major contributors of computing resources are listed in Ref. [116].

References

- [1] ATLAS Collaboration, *Observation of a new particle in the search for the Standard Model Higgs boson with the ATLAS detector at the LHC*, *Phys. Lett. B* **716** (2012) 1, arXiv: [1207.7214 \[hep-ex\]](#).
- [2] CMS Collaboration, *Observation of a new boson at a mass of 125 GeV with the CMS experiment at the LHC*, *Phys. Lett. B* **716** (2012) 30, arXiv: [1207.7235 \[hep-ex\]](#).
- [3] L. Susskind, *Dynamics of spontaneous symmetry breaking in the Weinberg-Salam theory*, *Phys. Rev. D* **20** (1979) 2619.
- [4] D. B. Kaplan, H. Georgi and S. Dimopoulos, *Composite Higgs scalars*, *Phys. Lett. B* **136** (1984) 187.
- [5] K. Agashe, R. Contino and A. Pomarol, *The minimal composite Higgs model*, *Nucl. Phys. B* **719** (2005) 165, arXiv: [hep-ph/0412089 \[hep-ph\]](#).
- [6] N. Arkani-Hamed, A. G. Cohen, E. Katz and A. E. Nelson, *The Littlest Higgs*, *JHEP* **07** (2002) 034, arXiv: [hep-ph/0206021 \[hep-ph\]](#).
- [7] M. Schmaltz and D. Tucker-Smith, *Little Higgs Theories*, *Ann. Rev. Nucl. Part. Sci.* **55** (2005) 229, arXiv: [hep-ph/0502182 \[hep-ph\]](#).
- [8] F. del Aguila and M. J. Bowick, *The possibility of new fermions with $\Delta I = 0$ mass*, *Nucl. Phys. B* **224** (1983) 107.
- [9] F. del Aguila, M. Perez-Victoria and J. Santiago, *Effective description of quark mixing*, *Phys. Lett. B* **492** (2000) 98, arXiv: [hep-ph/0007160 \[hep-ph\]](#).
- [10] F. del Aguila, J. Santiago and M. Perez-Victoria, *Observable contributions of new exotic quarks to quark mixing*, *JHEP* **09** (2000) 011, arXiv: [hep-ph/0007316 \[hep-ph\]](#).
- [11] J. A. Aguilar-Saavedra, *Identifying top partners at LHC*, *JHEP* **11** (2009) 030, arXiv: [0907.3155 \[hep-ph\]](#).
- [12] ATLAS Collaboration, *Combination of the searches for pair-produced vector-like partners of the third-generation quarks at $\sqrt{s} = 13$ TeV with the ATLAS detector*, *Phys. Rev. Lett.* **121** (2018) 211801, arXiv: [1808.02343 \[hep-ex\]](#).
- [13] ATLAS Collaboration, *Search for pair- and single-production of vector-like quarks in final states with at least one Z boson decaying into a pair of electrons or muons in pp collision data collected with the ATLAS detector*, *Phys. Rev. D* **98** (2018) 112010, arXiv: [1806.10555 \[hep-ex\]](#).
- [14] ATLAS Collaboration, *Search for pair production of heavy vector-like quarks decaying into hadronic final states in pp collisions at $\sqrt{s} = 13$ TeV with the ATLAS detector*, *Phys. Rev. D* **98** (2018) 092005, arXiv: [1808.01771 \[hep-ex\]](#).
- [15] ATLAS Collaboration, *Search for new phenomena in events with same-charge leptons and b-jets in pp collisions at $\sqrt{s} = 13$ TeV with the ATLAS detector*, *JHEP* **12** (2018) 039, arXiv: [1807.11883 \[hep-ex\]](#).

- [16] ATLAS Collaboration, *Search for pair production of heavy vector-like quarks decaying into high- p_T W bosons and top quarks in the lepton-plus-jets final state in pp collisions at $\sqrt{s} = 13$ TeV with the ATLAS detector*, *JHEP* **08** (2018) 048, arXiv: [1806.01762 \[hep-ex\]](#).
- [17] ATLAS Collaboration, *Search for pair production of up-type vector-like quarks and for four-top-quark events in final states with multiple b -jets with the ATLAS detector*, *JHEP* **07** (2018) 089, arXiv: [1803.09678 \[hep-ex\]](#).
- [18] ATLAS Collaboration, *Search for pair production of heavy vector-like quarks decaying to high- p_T W bosons and b quarks in the lepton-plus-jets final state in pp collisions at $\sqrt{s} = 13$ TeV with the ATLAS detector*, *JHEP* **10** (2017) 141, arXiv: [1707.03347 \[hep-ex\]](#).
- [19] ATLAS Collaboration, *Search for pair production of vector-like top quarks in events with one lepton, jets, and missing transverse momentum in $\sqrt{s} = 13$ TeV pp collisions with the ATLAS detector*, *JHEP* **08** (2017) 052, arXiv: [1705.10751 \[hep-ex\]](#).
- [20] CMS Collaboration, *Search for pair production of vector-like quarks in the fully hadronic final state*, *Phys. Rev. D* **100** (2019) 072001, arXiv: [1906.11903 \[hep-ex\]](#).
- [21] CMS Collaboration, *Search for vector-like quarks in events with two oppositely charged leptons and jets in proton–proton collisions at $\sqrt{s} = 13$ TeV*, *Eur. Phys. J. C* **79** (2019) 364, arXiv: [1812.09768 \[hep-ex\]](#).
- [22] CMS Collaboration, *Search for vector-like T and B quark pairs in final states with leptons at $\sqrt{s} = 13$ TeV*, *JHEP* **08** (2018) 177, arXiv: [1805.04758 \[hep-ex\]](#).
- [23] CMS Collaboration, *Search for pair production of vector-like quarks in the $bW\bar{b}W$ channel from proton–proton collisions at $\sqrt{s} = 13$ TeV*, *Phys. Lett. B* **779** (2018) 82, arXiv: [1710.01539 \[hep-ex\]](#).
- [24] CMS Collaboration, *A search for bottom-type, vector-like quark pair production in a fully hadronic final state in proton–proton collisions at $\sqrt{s} = 13$ TeV*, *Phys. Rev. D* **102** (2020) 112004, arXiv: [2008.09835 \[hep-ex\]](#).
- [25] CMS Collaboration, *Search for pair production of vector-like quarks in leptonic final states in proton–proton collisions at $\sqrt{s} = 13$ TeV*, (2022), arXiv: [2209.07327 \[hep-ex\]](#).
- [26] A. Buckley, J. M. Butterworth, L. Corpe, D. Huang and P. Sun, *New sensitivity of current LHC measurements to vector-like quarks*, *SciPost Phys.* **9** (2020) 069, arXiv: [2006.07172 \[hep-ph\]](#).
- [27] ATLAS Collaboration, *Search for large missing transverse momentum in association with one top-quark in proton–proton collisions at $\sqrt{s} = 13$ TeV with the ATLAS detector*, *JHEP* **05** (2019) 041, arXiv: [1812.09743 \[hep-ex\]](#).
- [28] ATLAS Collaboration, *Search for single production of vector-like quarks decaying into Wb in pp collisions at $\sqrt{s} = 13$ TeV with the ATLAS detector*, *JHEP* **05** (2019) 164, arXiv: [1812.07343 \[hep-ex\]](#).
- [29] CMS Collaboration, *Search for electroweak production of a vector-like T quark using fully hadronic final states*, *JHEP* **01** (2020) 036, arXiv: [1909.04721 \[hep-ex\]](#).
- [30] CMS Collaboration, *Search for single production of vector-like quarks decaying to a top quark and a W boson in proton–proton collisions at $\sqrt{s} = 13$ TeV*, *Eur. Phys. J. C* **79** (2019) 90, arXiv: [1809.08597 \[hep-ex\]](#).
- [31] CMS Collaboration, *Search for single production of vector-like quarks decaying to a b quark and a Higgs boson*, *JHEP* **06** (2018) 031, arXiv: [1802.01486 \[hep-ex\]](#).

- [32] CMS Collaboration, *Search for single production of a vector-like T quark decaying to a top quark and a Z boson in the final state with jets and missing transverse momentum at $\sqrt{s} = 13$ TeV*, *JHEP* **05** (2022) 093, arXiv: [2201.02227 \[hep-ex\]](#).
- [33] CMS Collaboration, *Search for a W' boson decaying to a vector-like quark and a top or bottom quark in the all-jets final state at $\sqrt{s} = 13$ TeV*, *JHEP* **09** (2022) 088, arXiv: [2202.12988 \[hep-ex\]](#).
- [34] A. Roy, N. Nikiforou, N. Castro and T. Andeen, *Novel interpretation strategy for searches of singly produced vectorlike quarks at the LHC*, *Phys. Rev. D* **101** (2020) 115027, arXiv: [2003.00640 \[hep-ph\]](#).
- [35] ATLAS Collaboration, *The ATLAS Experiment at the CERN Large Hadron Collider*, *JINST* **3** (2008) S08003.
- [36] ATLAS Collaboration, *ATLAS Insertable B-Layer Technical Design Report*, ATLAS-TDR-19; CERN-LHCC-2010-013, 2010, URL: <https://cds.cern.ch/record/1291633>, Addendum: ATLAS-TDR-19-ADD-1; CERN-LHCC-2012-009, 2012, URL: <https://cds.cern.ch/record/1451888>.
- [37] B. Abbott et al., *Production and integration of the ATLAS Insertable B-Layer*, *JINST* **13** (2018) T05008, arXiv: [1803.00844 \[physics.ins-det\]](#).
- [38] ATLAS Collaboration, *Performance of the ATLAS trigger system in 2015*, *Eur. Phys. J. C* **77** (2017) 317, arXiv: [1611.09661 \[hep-ex\]](#).
- [39] ATLAS Collaboration, *The ATLAS Collaboration Software and Firmware*, ATL-SOFT-PUB-2021-001, 2021, URL: <https://cds.cern.ch/record/2767187>.
- [40] ATLAS Collaboration, *The ATLAS Simulation Infrastructure*, *Eur. Phys. J. C* **70** (2010) 823, arXiv: [1005.4568 \[physics.ins-det\]](#).
- [41] GEANT4 Collaboration, S. Agostinelli et al., *GEANT4 – a simulation toolkit*, *Nucl. Instrum. Meth. A* **506** (2003) 250.
- [42] T. Gleisberg et al., *Event generation with SHERPA 1.1*, *JHEP* **02** (2009) 007, arXiv: [0811.4622 \[hep-ph\]](#).
- [43] S. Höche, F. Krauss, S. Schumann and F. Siegert, *QCD matrix elements and truncated showers*, *JHEP* **05** (2009) 053, arXiv: [0903.1219 \[hep-ph\]](#).
- [44] T. Gleisberg and S. Höche, *Comix, a new matrix element generator*, *JHEP* **12** (2008) 039, arXiv: [0808.3674 \[hep-ph\]](#).
- [45] S. Schumann and F. Krauss, *A parton shower algorithm based on Catani–Seymour dipole factorisation*, *JHEP* **03** (2008) 038, arXiv: [0709.1027 \[hep-ph\]](#).
- [46] R. D. Ball et al., *Parton distributions for the LHC run II*, *JHEP* **04** (2015) 040, arXiv: [1410.8849 \[hep-ph\]](#).
- [47] C. Anastasiou, L. Dixon, K. Melnikov and F. Petriello, *High-precision QCD at hadron colliders: Electroweak gauge boson rapidity distributions at next-to-next-to leading order*, *Phys. Rev. D* **69** (2004) 094008, arXiv: [hep-ph/0312266](#).
- [48] F. Cascioli, P. Maierhöfer and S. Pozzorini, *Scattering Amplitudes with Open Loops*, *Phys. Rev. Lett.* **108** (2012) 111601, arXiv: [1111.5206 \[hep-ph\]](#).
- [49] S. Höche, F. Krauss, M. Schönherr and F. Siegert, *QCD matrix elements + parton showers. The NLO case*, *JHEP* **04** (2013) 027, arXiv: [1207.5030 \[hep-ph\]](#).

- [50] J. Alwall et al., *The automated computation of tree-level and next-to-leading order differential cross sections, and their matching to parton shower simulations*, **JHEP** **07** (2014) 079, arXiv: [1405.0301 \[hep-ph\]](#).
- [51] T. Sjöstrand et al., *An introduction to PYTHIA 8.2*, **Comput. Phys. Commun.** **191** (2015) 159, arXiv: [1410.3012 \[hep-ph\]](#).
- [52] ATLAS Collaboration, *ATLAS Pythia 8 tunes to 7 TeV data*, ATL-PHYS-PUB-2014-021, 2014, URL: <https://cds.cern.ch/record/1966419>.
- [53] ATLAS Collaboration, *Monte Carlo Generators for the Production of a W or Z/ γ^* Boson in Association with Jets at ATLAS in Run 2*, ATL-PHYS-PUB-2016-003, 2016, URL: <https://cds.cern.ch/record/2120133>.
- [54] P. Nason, *A new method for combining NLO QCD with shower Monte Carlo algorithms*, **JHEP** **11** (2004) 040, arXiv: [hep-ph/0409146](#).
- [55] S. Frixione, P. Nason and C. Oleari, *Matching NLO QCD computations with parton shower simulations: the POWHEG method*, **JHEP** **11** (2007) 070, arXiv: [0709.2092 \[hep-ph\]](#).
- [56] S. Alioli, P. Nason, C. Oleari and E. Re, *A general framework for implementing NLO calculations in shower Monte Carlo programs: the POWHEG BOX*, **JHEP** **06** (2010) 043, arXiv: [1002.2581 \[hep-ph\]](#).
- [57] J. M. Campbell, R. K. Ellis, P. Nason and E. Re, *Top-Pair Production and Decay at NLO Matched with Parton Showers*, **JHEP** **04** (2015) 114, arXiv: [1412.1828 \[hep-ph\]](#).
- [58] M. Czakon and A. Mitov, *Top++: A program for the calculation of the top-pair cross-section at hadron colliders*, **Comput. Phys. Commun.** **185** (2014) 2930, arXiv: [1112.5675 \[hep-ph\]](#).
- [59] M. Czakon, P. Fiedler and A. Mitov, *Total Top-Quark Pair-Production Cross Section at Hadron Colliders Through $O(\alpha_s^4)$* , **Phys. Rev. Lett.** **110** (2013) 252004, arXiv: [1303.6254 \[hep-ph\]](#).
- [60] M. Beneke, P. Falgari, S. Klein and C. Schwinn, *Hadronic top-quark pair production with NNLL threshold resummation*, **Nucl. Phys. B** **855** (2012) 695, arXiv: [1109.1536 \[hep-ph\]](#).
- [61] M. Cacciari, M. Czakon, M. Mangano, A. Mitov and P. Nason, *Top-pair production at hadron colliders with next-to-next-to-leading logarithmic soft-gluon resummation*, **Phys. Lett. B** **710** (2012) 612, arXiv: [1111.5869 \[hep-ph\]](#).
- [62] M. Czakon and A. Mitov, *NNLO corrections to top pair production at hadron colliders: the quark-gluon reaction*, **JHEP** **01** (2013) 080, arXiv: [1210.6832 \[hep-ph\]](#).
- [63] M. Czakon and A. Mitov, *NNLO corrections to top-pair production at hadron colliders: the all-fermionic scattering channels*, **JHEP** **12** (2012) 054, arXiv: [1207.0236 \[hep-ph\]](#).
- [64] P. Bärnreuther, M. Czakon and A. Mitov, *Percent-Level-Precision Physics at the Tevatron: Next-to-Next-to-Leading Order QCD Corrections to $q\bar{q} \rightarrow t\bar{t} + X$* , **Phys. Rev. Lett.** **109** (2012) 132001, arXiv: [1204.5201 \[hep-ph\]](#).
- [65] J. Bellm et al., *Herwig 7.0/Herwig++ 3.0 release note*, **Eur. Phys. J. C** **76** (2016) 196, arXiv: [1512.01178 \[hep-ph\]](#).
- [66] ATLAS Collaboration, *Improvements in $t\bar{t}$ modelling using NLO+PS Monte Carlo generators for Run 2*, ATL-PHYS-PUB-2018-009, 2018, URL: <https://cds.cern.ch/record/2630327>.
- [67] R. Frederix, D. Pagani and M. Zaro, *Large NLO corrections in $t\bar{t}W^\pm$ and $t\bar{t}\bar{t}$ hadroproduction from supposedly subleading EW contributions*, **JHEP** **02** (2018) 031, arXiv: [1711.02116 \[hep-ph\]](#).

- [68] R. Frederix, E. Re and P. Torrielli, *Single-top t -channel hadroproduction in the four-flavour scheme with POWHEG and aMC@NLO*, *JHEP* **09** (2012) 130, arXiv: [1207.5391 \[hep-ph\]](#).
- [69] E. Re, *Single-top Wt -channel production matched with parton showers using the POWHEG method*, *Eur. Phys. J. C* **71** (2011) 1547, arXiv: [1009.2450 \[hep-ph\]](#).
- [70] M. Aliev et al., *HATHOR – HAdronic Top and Heavy quarks crOss section calculatoR*, *Comput. Phys. Commun.* **182** (2011) 1034, arXiv: [1007.1327 \[hep-ph\]](#).
- [71] P. Kant et al., *HatHor for single top-quark production: Updated predictions and uncertainty estimates for single top-quark production in hadronic collisions*, *Comput. Phys. Commun.* **191** (2015) 74, arXiv: [1406.4403 \[hep-ph\]](#).
- [72] N. Kidonakis, *Next-to-next-to-leading-order collinear and soft gluon corrections for t -channel single top quark production*, *Phys. Rev. D* **83** (2011) 091503, arXiv: [1103.2792 \[hep-ph\]](#).
- [73] N. Kidonakis, *Two-loop soft anomalous dimensions for single top quark associated production with a W^- or H^-* , *Phys. Rev. D* **82** (2010) 054018, arXiv: [1005.4451 \[hep-ph\]](#).
- [74] N. Kidonakis, *Next-to-next-to-leading logarithm resummation for s -channel single top quark production*, *Phys. Rev. D* **81** (2010) 054028, arXiv: [1001.5034 \[hep-ph\]](#).
- [75] S. Frixione, E. Laenen, P. Motylinski, C. White and B. R. Webber, *Single-top hadroproduction in association with a W boson*, *JHEP* **07** (2008) 029, arXiv: [0805.3067 \[hep-ph\]](#).
- [76] J. A. Aguilar-Saavedra, *Protos - PROgram for TOp Simulations*, URL: <http://jaguilar.web.cern.ch/jaguilar/protos>.
- [77] A. D. Martin, W. J. Stirling, R. S. Thorne and G. Watt, *Parton distributions for the LHC*, *Eur. Phys. J. C* **63** (2009) 189, arXiv: [0901.0002 \[hep-ph\]](#).
- [78] A. D. Martin, W. J. Stirling, R. S. Thorne and G. Watt, *Uncertainties on α_S in global PDF analyses and implications for predicted hadronic cross sections*, *Eur. Phys. J. C* **64** (2009) 653, arXiv: [0905.3531 \[hep-ph\]](#).
- [79] A. D. Martin, W. J. Stirling, R. S. Thorne and G. Watt, *Heavy-quark mass dependence in global PDF analyses and 3- and 4-flavour parton distributions*, *Eur. Phys. J. C* **70** (2010) 51, arXiv: [1007.2624 \[hep-ph\]](#).
- [80] ATLAS Collaboration, *Electron and photon performance measurements with the ATLAS detector using the 2015–2017 LHC proton–proton collision data*, *JINST* **14** (2019) P12006, arXiv: [1908.00005 \[hep-ex\]](#).
- [81] ATLAS Collaboration, *Muon reconstruction and identification efficiency in ATLAS using the full Run 2 pp collision data set at $\sqrt{s} = 13$ TeV*, *Eur. Phys. J. C* **81** (2021) 578, arXiv: [2012.00578 \[hep-ex\]](#).
- [82] ATLAS Collaboration, *Studies of the muon momentum calibration and performance of the ATLAS detector with pp collisions at $\sqrt{s} = 13$ TeV*, (2022), arXiv: [2212.07338 \[hep-ex\]](#).
- [83] M. Cacciari, G. P. Salam and G. Soyez, *The anti- k_t jet clustering algorithm*, *JHEP* **04** (2008) 063, arXiv: [0802.1189 \[hep-ph\]](#).
- [84] M. Cacciari, G. P. Salam and G. Soyez, *FastJet user manual*, *Eur. Phys. J. C* **72** (2012) 1896, arXiv: [1111.6097 \[hep-ph\]](#).
- [85] ATLAS Collaboration, *Topological cell clustering in the ATLAS calorimeters and its performance in LHC Run 1*, *Eur. Phys. J. C* **77** (2017) 490, arXiv: [1603.02934 \[hep-ex\]](#).

- [86] ATLAS Collaboration, *Properties of jets and inputs to jet reconstruction and calibration with the ATLAS detector using proton–proton collisions at $\sqrt{s} = 13$ TeV*, ATL-PHYS-PUB-2015-036, 2015, URL: <https://cds.cern.ch/record/2044564>.
- [87] ATLAS Collaboration, *Jet energy scale measurements and their systematic uncertainties in proton–proton collisions at $\sqrt{s} = 13$ TeV with the ATLAS detector*, *Phys. Rev. D* **96** (2017) 072002, arXiv: [1703.09665](https://arxiv.org/abs/1703.09665) [hep-ex].
- [88] ATLAS Collaboration, *Performance of pile-up mitigation techniques for jets in pp collisions at $\sqrt{s} = 8$ TeV using the ATLAS detector*, *Eur. Phys. J. C* **76** (2016) 581, arXiv: [1510.03823](https://arxiv.org/abs/1510.03823) [hep-ex].
- [89] ATLAS Collaboration, *ATLAS b-jet identification performance and efficiency measurement with $t\bar{t}$ events in pp collisions at $\sqrt{s} = 13$ TeV*, *Eur. Phys. J. C* **79** (2019) 970, arXiv: [1907.05120](https://arxiv.org/abs/1907.05120) [hep-ex].
- [90] ATLAS Collaboration, *Performance of missing transverse momentum reconstruction with the ATLAS detector using proton–proton collisions at $\sqrt{s} = 13$ TeV*, *Eur. Phys. J. C* **78** (2018) 903, arXiv: [1802.08168](https://arxiv.org/abs/1802.08168) [hep-ex].
- [91] B. Nachman, P. Nef, A. Schwartzman, M. Swiatlowski and C. Wanotayaroj, *Jets from Jets: Re-clustering as a tool for large radius jet reconstruction and grooming at the LHC*, *JHEP* **02** (2015) 075, arXiv: [1407.2922](https://arxiv.org/abs/1407.2922) [hep-ph].
- [92] D. Krohn, J. Thaler and L.-T. Wang, *Jet trimming*, *JHEP* **02** (2010) 084, arXiv: [0912.1342](https://arxiv.org/abs/0912.1342) [hep-ph].
- [93] ATLAS Collaboration, *Performance of the ATLAS muon triggers in Run 2*, *JINST* **15** (2020) P09015, arXiv: [2004.13447](https://arxiv.org/abs/2004.13447) [hep-ex].
- [94] ATLAS Collaboration, *Performance of electron and photon triggers in ATLAS during LHC Run 2*, *Eur. Phys. J. C* **80** (2020) 47, arXiv: [1909.00761](https://arxiv.org/abs/1909.00761) [hep-ex].
- [95] F. Chollet et al., *Keras*, 2015, URL: <https://keras.io>.
- [96] Martín Abadi et al., *TensorFlow: Large-Scale Machine Learning on Heterogeneous Systems*, 2015, URL: <https://www.tensorflow.org/>.
- [97] K. Agashe, H. Davoudiasl, G. Perez and A. Soni, *Warped gravitons at the CERN LHC and beyond*, *Phys. Rev. D* **76** (2007) 036006, arXiv: [hep-ph/0701186](https://arxiv.org/abs/hep-ph/0701186).
- [98] J. Schmidhuber, *Deep learning in neural networks: An overview*, *Neural Networks* **61** (2015) 85.
- [99] I. Goodfellow, Y. Bengio and A. Courville, *Deep Learning*, <http://www.deeplearningbook.org>, MIT Press, 2016.
- [100] D. P. Kingma and J. Ba, *Adam: A Method for Stochastic Optimization*, 2014, arXiv: [1412.6980](https://arxiv.org/abs/1412.6980) [cs.LG].
- [101] ATLAS Collaboration, *Optimisation of large-radius jet reconstruction for the ATLAS detector in 13 TeV proton–proton collisions*, *Eur. Phys. J. C* **81** (2020) 334, arXiv: [2009.04986](https://arxiv.org/abs/2009.04986) [hep-ex].
- [102] ATLAS Collaboration, *Measurement of the c-jet mistagging efficiency in $t\bar{t}$ events using pp collision data at $\sqrt{s} = 13$ TeV collected with the ATLAS detector*, *Eur. Phys. J. C* **82** (2021) 95, arXiv: [2109.10627](https://arxiv.org/abs/2109.10627) [hep-ex].
- [103] ATLAS Collaboration, *Calibration of light-flavour b-jet mistagging rates using ATLAS proton–proton collision data at $\sqrt{s} = 13$ TeV*, ATL-CONF-2018-006, 2018, URL: <https://cds.cern.ch/record/2314418>.

- [104] ATLAS Collaboration, *Luminosity determination in pp collisions at $\sqrt{s} = 13$ TeV using the ATLAS detector at the LHC*, ATLAS-CONF-2019-021, 2019, URL: <https://cds.cern.ch/record/2677054>.
- [105] ATLAS Collaboration, *Measurements of the inclusive and differential production cross sections of a top-quark-antiquark pair in association with a Z boson at $\sqrt{s} = 13$ TeV with the ATLAS detector*, *Eur. Phys. J. C* **81** (2021) 737, arXiv: [2103.12603](https://arxiv.org/abs/2103.12603) [hep-ex].
- [106] ATLAS Collaboration, *Higgs boson production cross-section measurements and their EFT interpretation in the 4ℓ decay channel at $\sqrt{s} = 13$ TeV with the ATLAS detector*, *Eur. Phys. J. C* **80** (2020) 957, arXiv: [2004.03447](https://arxiv.org/abs/2004.03447) [hep-ex], Erratum: *Eur. Phys. J. C* **81** (2021) 29.
- [107] J. Butterworth et al., *PDF4LHC recommendations for LHC Run II*, *J. Phys. G* **43** (2016) 023001, arXiv: [1510.03865](https://arxiv.org/abs/1510.03865) [hep-ph].
- [108] H.-L. Lai et al., *New parton distributions for collider physics*, *Phys. Rev. D* **82** (2010) 074024, arXiv: [1007.2241](https://arxiv.org/abs/1007.2241) [hep-ph].
- [109] J. Gao et al., *CT10 next-to-next-to-leading order global analysis of QCD*, *Phys. Rev. D* **89** (2014) 033009, arXiv: [1302.6246](https://arxiv.org/abs/1302.6246) [hep-ph].
- [110] G. Cowan, K. Cranmer, E. Gross and O. Vitells, *Asymptotic formulae for likelihood-based tests of new physics*, *Eur. Phys. J. C* **71** (2011) 1554, arXiv: [1007.1727](https://arxiv.org/abs/1007.1727) [physics.data-an], Erratum: *Eur. Phys. J. C* **73** (2013) 2501.
- [111] L. Moneta et al., *The RooStats Project*, *PoS ACAT2010* (2010) 057, ed. by T. Speer et al., arXiv: [1009.1003](https://arxiv.org/abs/1009.1003) [physics.data-an].
- [112] W. Verkerke and D. Kirkby, *The RooFit toolkit for data modeling*, 2003, arXiv: [physics/0306116](https://arxiv.org/abs/physics/0306116) [physics.data-an].
- [113] K. Cranmer, G. Lewis, L. Moneta, A. Shibata and W. Verkerke, *HistFactory: A tool for creating statistical models for use with RooFit and RooStats*, tech. rep., New York U., 2012, URL: <https://cds.cern.ch/record/1456844>.
- [114] T. Junk, *Confidence level computation for combining searches with small statistics*, *Nucl. Instrum. Meth. A* **434** (1999) 435, arXiv: [hep-ex/9902006](https://arxiv.org/abs/hep-ex/9902006) [hep-ex].
- [115] A. L. Read, *Presentation of search results: the CL_s technique*, *J. Phys. G* **28** (2002) 2693.
- [116] ATLAS Collaboration, *ATLAS Computing Acknowledgements*, ATL-SOFT-PUB-2021-003, 2021, URL: <https://cds.cern.ch/record/2776662>.

The ATLAS Collaboration

G. Aad ¹⁰⁰, B. Abbott ¹¹⁷, D.C. Abbott ¹⁰¹, A. Abed Abud ³⁴, K. Abeling ⁵³,
D.K. Abhayasinghe ⁹², S.H. Abidi ²⁷, H. Abramowicz ¹⁴⁹, H. Abreu ¹⁴⁸, Y. Abulaiti ⁵,
A.C. Abusleme Hoffman ^{134a}, B.S. Acharya ^{66a,66b,q}, B. Achkar ⁵³, L. Adam ⁹⁸,
C. Adam Bourdarios ⁴, L. Adamczyk ^{82a}, L. Adamek ¹⁵³, S.V. Addepalli ²⁴, J. Adelman ¹¹³,
A. Adiguzel ^{11c,ac}, S. Adorni ⁵⁴, T. Adye ¹³¹, A.A. Affolder ¹³³, Y. Afik ¹⁴⁸, C. Agapopoulou ⁶⁴,
M.N. Agaras ¹², J. Agarwala ^{70a,70b}, A. Aggarwal ¹¹¹, C. Agheorghiesei ^{25c},
J.A. Aguilar-Saavedra ^{127f,127a,ab}, A. Ahmad ³⁴, F. Ahmadov ^{36,z}, W.S. Ahmed ¹⁰², X. Ai ⁴⁶,
G. Aielli ^{73a,73b}, I. Aizenberg ¹⁶⁶, S. Akatsuka ⁸⁴, M. Akbiyik ⁹⁸, T.P.A. Åkesson ⁹⁵,
A.V. Akimov ³⁵, K. Al Khoury ³⁹, G.L. Alberghi ^{21b}, J. Albert ¹⁶², P. Albicocco ⁵¹,
M.J. Alconada Verzini ⁸⁷, S. Alderweireldt ⁵⁰, M. Aleksa ³⁴, I.N. Aleksandrov ³⁶, C. Alexa ^{25b},
T. Alexopoulos ⁹, A. Alfonsi ¹¹², F. Alfonsi ^{21b}, M. Alhroob ¹¹⁷, B. Ali ¹²⁹, S. Ali ¹⁴⁶,
M. Aliev ³⁵, G. Alimonti ^{68a}, C. Allaire ³⁴, B.M.M. Allbrooke ¹⁴⁴, P.P. Allport ¹⁹,
A. Aloisio ^{69a,69b}, F. Alonso ⁸⁷, C. Alpigiani ¹³⁶, E. Alunno Camelia ^{73a,73b}, M. Alvarez Estevez ⁹⁷,
M.G. Alvigi ^{69a,69b}, Y. Amaral Coutinho ^{79b}, A. Ambler ¹⁰², L. Ambroz ¹²³, C. Amelung ³⁴,
D. Amidei ¹⁰⁴, S.P. Amor Dos Santos ^{127a}, S. Amoroso ⁴⁶, C.S. Amrouche ⁵⁴, C. Anastopoulos ¹³⁷,
N. Andari ¹³², T. Andeen ¹⁰, J.K. Anders ¹⁸, S.Y. Andrean ^{45a,45b}, A. Andreazza ^{68a,68b},
S. Angelidakis ⁸, A. Angerami ³⁹, A.V. Anisenkov ³⁵, A. Annovi ^{71a}, C. Antel ⁵⁴,
M.T. Anthony ¹³⁷, E. Antipov ¹¹⁸, M. Antonelli ⁵¹, D.J.A. Antrim ^{16a}, F. Anulli ^{72a}, M. Aoki ⁸⁰,
J.A. Aparisi Pozo ¹⁶⁰, M.A. Aparo ¹⁴⁴, L. Aperio Bella ⁴⁶, N. Aranzabal ³⁴, V. Araujo Ferraz ^{79a},
C. Arcangeletti ⁵¹, A.T.H. Arce ⁴⁹, E. Arena ⁸⁹, J-F. Arguin ¹⁰⁶, S. Argyropoulos ⁵²,
J.-H. Arling ⁴⁶, A.J. Armbruster ³⁴, A. Armstrong ¹⁵⁷, O. Arnaez ¹⁵³, H. Arnold ³⁴,
Z.P. Arrubarrena Tame ¹⁰⁷, G. Artoni ¹²³, H. Asada ¹⁰⁹, K. Asai ¹¹⁵, S. Asai ¹⁵¹, N.A. Asbah ⁵⁹,
E.M. Asimakopoulou ¹⁵⁸, L. Asquith ¹⁴⁴, J. Assahsah ^{33d}, K. Assamagan ²⁷, R. Astalos ^{26a},
R.J. Atkin ^{31a}, M. Atkinson ¹⁵⁹, N.B. Atlay ¹⁷, H. Atmani ^{60b}, P.A. Atmasiddha ¹⁰⁴, K. Augsten ¹²⁹,
S. Auricchio ^{69a,69b}, V.A. Austrup ¹⁶⁸, G. Avner ¹⁴⁸, G. Avolio ³⁴, M.K. Ayoub ^{13c},
G. Azuelos ^{106,ah}, D. Babal ^{26a}, H. Bachacou ¹³², K. Bachas ¹⁵⁰, A. Bachi ³²,
F. Backman ^{45a,45b}, A. Badea ⁵⁹, P. Bagnaia ^{72a,72b}, H. Bahrasemani ¹⁴⁰, A.J. Bailey ¹⁶⁰,
V.R. Bailey ¹⁵⁹, J.T. Baines ¹³¹, C. Bakalis ⁹, O.K. Baker ¹⁶⁹, P.J. Bakker ¹¹², E. Bakos ¹⁴,
D. Bakshi Gupta ⁷, S. Balaji ¹⁴⁵, R. Balasubramanian ¹¹², E.M. Baldin ³⁵, P. Balek ¹³⁰,
E. Ballabene ^{68a,68b}, F. Balli ¹³², W.K. Balunas ¹²³, J. Balz ⁹⁸, E. Banas ⁸³,
M. Bandieramonte ¹²⁶, A. Bandyopadhyay ¹⁷, S. Bansal ²², L. Barak ¹⁴⁹, E.L. Barberio ¹⁰³,
D. Barberis ^{55b,55a}, M. Barbero ¹⁰⁰, G. Barbour ⁹³, K.N. Barends ^{31a}, T. Barillari ¹⁰⁸,
M-S. Barisits ³⁴, J. Barkeloo ¹²⁰, T. Barklow ¹⁴¹, B.M. Barnett ¹³¹, R.M. Barnett ^{16a},
A. Baroncelli ^{60a}, G. Barone ²⁷, A.J. Barr ¹²³, L. Barranco Navarro ^{45a,45b}, F. Barreiro ⁹⁷,
J. Barreiro Guimarães da Costa ^{13a}, U. Barron ¹⁴⁹, S. Barsov ³⁵, F. Bartels ^{61a}, R. Bartoldus ¹⁴¹,
G. Bartolini ¹⁰⁰, A.E. Barton ⁸⁸, P. Bartos ^{26a}, A. Basalae ⁴⁶, A. Basan ⁹⁸, I. Bashta ^{74a,74b},
A. Bassalat ^{64,ad}, M.J. Basso ¹⁵³, C.R. Basson ⁹⁹, R.L. Bates ⁵⁷, S. Batlamous ^{33e}, J.R. Batley ³⁰,
B. Batool ¹³⁹, M. Battaglia ¹³³, M. Baucé ^{72a,72b}, F. Bauer ^{132,*}, P. Bauer ²², H.S. Bawa ²⁹,
A. Bayirli ^{11c}, J.B. Beacham ⁴⁹, T. Beau ¹²⁴, P.H. Beauchemin ¹⁵⁶, F. Becherer ⁵², P. Bechtel ²²,
H.P. Beck ^{18,r}, K. Becker ¹⁶⁴, C. Becot ⁴⁶, A.J. Beddall ^{11a}, V.A. Bednyakov ³⁶, C.P. Bee ¹⁴³,
T.A. Beermann ¹⁶⁸, M. Begalli ^{79b}, M. Beger ²⁷, A. Behera ¹⁴³, J.K. Behr ⁴⁶,
C. Beirao Da Cruz E Silva ³⁴, J.F. Beirer ^{53,34}, F. Beisiegel ²², M. Belfkir ⁴, G. Bella ¹⁴⁹,
L. Bellagamba ^{21b}, A. Bellerive ³², P. Bellos ¹⁹, K. Beloborodov ³⁵, K. Belotskiy ³⁵,
N.L. Belyaev ³⁵, D. Benckekroun ^{33a}, Y. Benhammou ¹⁴⁹, D.P. Benjamin ²⁷, M. Benoit ²⁷,

J.R. Bensinger ²⁴, S. Bentvelsen ¹¹², L. Beresford ³⁴, M. Beretta ⁵¹, D. Berge ¹⁷,
E. Bergeas Kuutmann ¹⁵⁸, N. Berger ⁴, B. Bergmann ¹²⁹, L.J. Bergsten ²⁴, J. Beringer ^{16a},
S. Berlendis ⁶, G. Bernardi ¹²⁴, C. Bernius ¹⁴¹, F.U. Bernlochner ²², T. Berry ⁹², P. Berta ¹³⁰,
A. Berthold ⁴⁸, I.A. Bertram ⁸⁸, O. Bessidskaia Bylund ¹⁶⁸, S. Bethke ¹⁰⁸, A. Betti ⁴²,
A.J. Bevan ⁹¹, S. Bhatta ¹⁴³, D.S. Bhattacharya ¹⁶³, P. Bhattarai ²⁴, V.S. Bhopatkar ⁵, R. Bi ¹²⁶,
R.M. Bianchi ¹²⁶, O. Biebel ¹⁰⁷, R. Bielski ¹²⁰, N.V. Biesuz ^{71a,71b}, M. Biglietti ^{74a},
T.R.V. Billoud ¹²⁹, M. Bindi ⁵³, A. Bingul ^{11d}, C. Bini ^{72a,72b}, S. Biondi ^{21b,21a}, A. Biondini ⁸⁹,
C.J. Birch-sykes ⁹⁹, G.A. Bird ^{19,131}, M. Birman ¹⁶⁶, T. Bisanz ³⁴, D. Biswas ^{167,1},
A. Bitadze ⁹⁹, C. Bittrich ⁴⁸, K. Bjørke ¹²², I. Bloch ⁴⁶, C. Blocker ²⁴, A. Blue ⁵⁷,
U. Blumenschein ⁹¹, J. Blumenthal ⁹⁸, G.J. Bobbink ¹¹², V.S. Bobrovnikov ³⁵, M. Boehler ⁵²,
D. Bogavac ¹², A.G. Bogdanchikov ³⁵, C. Bohm ^{45a}, V. Boisvert ⁹², P. Bokan ⁴⁶, T. Bold ^{82a},
M. Bomben ¹²⁴, M. Bona ⁹¹, M. Boonekamp ¹³², C.D. Booth ⁹², A.G. Borbély ⁵⁷,
H.M. Borecka-Bielska ¹⁰⁶, L.S. Borgna ⁹³, G. Borissov ⁸⁸, D. Bortoletto ¹²³, D. Boscherini ^{21b},
M. Bosman ¹², J.D. Bossio Sola ³⁴, K. Bouaouda ^{33a}, J. Boudreau ¹²⁶, E.V. Bouhova-Thacker ⁸⁸,
D. Boumediene ³⁸, R. Bouquet ¹²⁴, A. Boveia ¹¹⁶, J. Boyd ³⁴, D. Boye ²⁷, I.R. Boyko ³⁶,
A.J. Bozson ⁹², J. Bracinik ¹⁹, N. Brahimy ^{60d,60c}, G. Brandt ¹⁶⁸, O. Brandt ³⁰, F. Braren ⁴⁶,
B. Brau ¹⁰¹, J.E. Brau ¹²⁰, W.D. Breaden Madden ⁵⁷, K. Brendlinger ⁴⁶, R. Brenner ¹⁶⁶,
L. Brenner ³⁴, R. Brenner ¹⁵⁸, S. Bressler ¹⁶⁶, B. Brickwedde ⁹⁸, D.L. Briglin ¹⁹, D. Britton ⁵⁷,
D. Britzger ¹⁰⁸, I. Brock ²², R. Brock ¹⁰⁵, G. Brooijmans ³⁹, W.K. Brooks ^{134e}, E. Brost ²⁷,
P.A. Bruckman de Renstrom ⁸³, B. Brüers ⁴⁶, D. Bruncko ^{26b,*}, A. Bruni ^{21b}, G. Bruni ^{21b},
M. Bruschi ^{21b}, N. Bruscinò ^{72a,72b}, L. Bryngemark ¹⁴¹, T. Buanes ¹⁵, Q. Buat ¹⁴³,
P. Buchholz ¹³⁹, A.G. Buckley ⁵⁷, I.A. Budagov ^{36,*}, M.K. Bugge ¹²², O. Bulekov ³⁵,
B.A. Bullard ⁵⁹, T.J. Burch ¹¹³, S. Burdin ⁸⁹, C.D. Burgard ⁴⁶, A.M. Burger ¹¹⁸,
B. Burghgrave ⁷, J.T.P. Burr ⁴⁶, C.D. Burton ¹⁰, J.C. Burzynski ¹⁰¹, V. Büscher ⁹⁸,
P.J. Bussey ⁵⁷, J.M. Butler ²³, C.M. Buttar ⁵⁷, J.M. Butterworth ⁹³, W. Buttinger ¹³¹,
C.J. Buxo Vazquez ¹⁰⁵, A.R. Buzykaev ³⁵, G. Cabras ^{21b}, S. Cabrera Urbán ¹⁶⁰, D. Caforio ⁵⁶,
H. Cai ¹²⁶, V.M.M. Cairo ¹⁴¹, O. Cakir ^{3a}, N. Calace ³⁴, P. Calafiura ^{16a}, G. Calderini ¹²⁴,
P. Calfayan ⁶⁵, G. Callea ⁵⁷, L.P. Caloba ^{79b}, S. Calvente Lopez ⁹⁷, D. Calvet ³⁸, S. Calvet ³⁸,
T.P. Calvet ¹⁰⁰, M. Calvetti ^{71a,71b}, R. Camacho Toro ¹²⁴, S. Camarda ³⁴, D. Camarero Munoz ⁹⁷,
P. Camarri ^{73a,73b}, M.T. Camerlingo ^{74a,74b}, D. Cameron ¹²², C. Camincher ¹⁶², M. Campanelli ⁹³,
A. Camplani ⁴⁰, V. Canale ^{69a,69b}, A. Canesse ¹⁰², M. Cano Bret ⁷⁷, J. Cantero ¹¹⁸, Y. Cao ¹⁵⁹,
F. Capocasa ²⁴, M. Capua ^{41b,41a}, A. Carbone ^{68a,68b}, R. Cardarelli ^{73a}, J.C.J. Cardenas ⁷,
F. Cardillo ¹⁶⁰, T. Carli ³⁴, G. Carlino ^{69a}, B.T. Carlson ¹²⁶, E.M. Carlson ^{162,154a},
L. Carminati ^{68a,68b}, M. Carnesale ^{72a,72b}, R.M.D. Carney ¹⁴¹, S. Caron ¹¹¹, E. Carquin ^{134e},
S. Carrá ⁴⁶, G. Carratta ^{21b,21a}, J.W.S. Carter ¹⁵³, T.M. Carter ⁵⁰, D. Casadei ^{31c},
M.P. Casado ^{12,i}, A.F. Casha ¹⁵³, E.G. Castiglia ¹⁶⁹, F.L. Castillo ^{61a}, L. Castillo Garcia ¹²,
V. Castillo Gimenez ¹⁶⁰, N.F. Castro ^{127a,127e}, A. Catinaccio ³⁴, J.R. Catmore ¹²², A. Cattai ³⁴,
V. Cavaliere ²⁷, N. Cavalli ^{21b,21a}, V. Cavasinni ^{71a,71b}, E. Celebi ^{11b}, F. Celli ¹²³,
M.S. Centonze ^{67a,67b}, K. Cerny ¹¹⁹, A.S. Cerqueira ^{79a}, A. Cerri ¹⁴⁴, L. Cerrito ^{73a,73b},
F. Cerutti ^{16a}, A. Cervelli ^{21b}, S.A. Cetin ^{11b}, Z. Chadi ^{33a}, D. Chakraborty ¹¹³, M. Chala ^{127f},
J. Chan ¹⁶⁷, W.S. Chan ¹¹², W.Y. Chan ⁸⁹, J.D. Chapman ³⁰, B. Chargeishvili ^{147b},
D.G. Charlton ¹⁹, T.P. Charman ⁹¹, M. Chatterjee ¹⁸, S. Chekanov ⁵, S.V. Chekulaev ^{154a},
G.A. Chelkov ^{36,a}, A. Chen ¹⁰⁴, B. Chen ¹⁴⁹, C. Chen ^{60a}, C.H. Chen ⁷⁸, H. Chen ^{13c},
H. Chen ²⁷, J. Chen ^{60c}, J. Chen ²⁴, S. Chen ¹²⁵, S.J. Chen ^{13c}, X. Chen ^{60c}, X. Chen ^{13b,ag},
Y. Chen ^{60a}, Y-H. Chen ⁴⁶, C.L. Cheng ¹⁶⁷, H.C. Cheng ^{62a}, A. Cheplakov ³⁶,
E. Cheremushkina ⁴⁶, E. Cherepanova ³⁶, R. Cherkaoui El Moursli ^{33e}, E. Cheu ⁶, K. Cheung ⁶³,
L. Chevalier ¹³², V. Chiarella ⁵¹, G. Chiarelli ^{71a}, G. Chiodini ^{67a}, A.S. Chisholm ¹⁹,

A. Chitan ^{id}25b, Y.H. Chiu ^{id}162, M.V. Chizhov ^{id}36,s, K. Choi ^{id}10, A.R. Chomont ^{id}72a,72b, Y. Chou ^{id}101, E.Y.S. Chow ^{id}112, L.D. Christopher ^{id}31f, M.C. Chu ^{id}62a, X. Chu ^{id}13a,13d, J. Chudoba ^{id}128, J.J. Chwastowski ^{id}83, D. Cieri ^{id}108, K.M. Ciesla ^{id}83, V. Cindro ^{id}90, I.A. Cioară ^{id}25b, A. Ciocio ^{id}16a, F. Cirotto ^{id}69a,69b, Z.H. Citron ^{id}166,m, M. Citterio ^{id}68a, D.A. Ciubotaru ^{id}25b, B.M. Ciungu ^{id}153, A. Clark ^{id}54, P.J. Clark ^{id}50, J.M. Clavijo Columbie ^{id}46, S.E. Clawson ^{id}99, C. Clement ^{id}45a,45b, L. Clissa ^{id}21b,21a, Y. Coadou ^{id}100, M. Cobal ^{id}66a,66c, A. Coccaro ^{id}55b, J. Cochran ^{id}78, R.F. Coelho Barrue ^{id}127a, R. Coelho Lopes De Sa ^{id}101, S. Coelli ^{id}68a, H. Cohen ^{id}149, A.E.C. Coimbra ^{id}34, B. Cole ^{id}39, J. Collot ^{id}58, P. Conde Muiño ^{id}127a,127h, S.H. Connell ^{id}31c, I.A. Connelly ^{id}57, E.I. Conroy ^{id}123, F. Conventi ^{id}69a,ai, H.G. Cooke ^{id}19, A.M. Cooper-Sarkar ^{id}123, F. Cormier ^{id}161, L.D. Corpe ^{id}34, M. Corradi ^{id}72a,72b, E.E. Corrigan ^{id}95, F. Corriveau ^{id}102,y, M.J. Costa ^{id}160, F. Costanza ^{id}4, D. Costanzo ^{id}137, B.M. Cote ^{id}116, G. Cowan ^{id}92, J.W. Cowley ^{id}30, K. Cranmer ^{id}114, S. Crépe-Renaudin ^{id}58, F. Crescioli ^{id}124, M. Cristinziani ^{id}139, M. Cristoforetti ^{id}75a,75b,c, V. Croft ^{id}156, G. Crosetti ^{id}41b,41a, A. Cueto ^{id}34, T. Cuhadar Donszelmann ^{id}157, H. Cui ^{id}13a,13d, A.R. Cukierman ^{id}141, W.R. Cunningham ^{id}57, P. Czodrowski ^{id}34, M.M. Czurylo ^{id}61b, M.J. Da Cunha Sargedas De Sousa ^{id}60a, J.V. Da Fonseca Pinto ^{id}79b, C. Da Via ^{id}99, W. Dabrowski ^{id}82a, T. Dado ^{id}47, S. Dahbi ^{id}31f, T. Dai ^{id}104, C. Dallapiccola ^{id}101, M. Dam ^{id}40, G. D'amen ^{id}27, V. D'Amico ^{id}74a,74b, J. Damp ^{id}98, J.R. Dandoy ^{id}125, M.F. Daneri ^{id}28, M. Danninger ^{id}140, V. Dao ^{id}34, G. Darbo ^{id}55b, S. Darmora ^{id}5, A. Dattagupta ^{id}120, S. D'Auria ^{id}68a,68b, C. David ^{id}154b, T. Davidek ^{id}130, D.R. Davis ^{id}49, B. Davis-Purcell ^{id}32, I. Dawson ^{id}91, K. De ^{id}7, R. De Asmundis ^{id}69a, M. De Beurs ^{id}112, S. De Castro ^{id}21b,21a, N. De Groot ^{id}111, P. de Jong ^{id}112, H. De la Torre ^{id}105, A. De Maria ^{id}13c, D. De Pedis ^{id}72a, A. De Salvo ^{id}72a, U. De Sanctis ^{id}73a,73b, M. De Santis ^{id}73a,73b, A. De Santo ^{id}144, J.B. De Vivie De Regie ^{id}58, D.V. Dedovich ^{id}36, J. Degens ^{id}112, A.M. Deiana ^{id}42, J. Del Peso ^{id}97, Y. Delabat Diaz ^{id}46, F. Deliot ^{id}132, C.M. Delitzsch ^{id}6, M. Della Pietra ^{id}69a,69b, D. Della Volpe ^{id}54, A. Dell'Acqua ^{id}34, L. Dell'Asta ^{id}68a,68b, M. Delmastro ^{id}4, P.A. Delsart ^{id}58, S. Demers ^{id}169, M. Demichev ^{id}36, S.P. Denisov ^{id}35, L. D'Eramo ^{id}113, D. Derendarz ^{id}83, J.E. Derkaoui ^{id}33d, F. Derue ^{id}124, P. Dervan ^{id}89, K. Desch ^{id}22, K. Dette ^{id}153, C. Deutsch ^{id}22, P.O. Deviveiros ^{id}34, F.A. Di Bello ^{id}72a,72b, A. Di Ciaccio ^{id}73a,73b, L. Di Ciaccio ^{id}4, C. Di Donato ^{id}69a,69b, A. Di Girolamo ^{id}34, G. Di Gregorio ^{id}71a,71b, A. Di Luca ^{id}75a,75b, B. Di Micco ^{id}74a,74b, R. Di Nardo ^{id}74a,74b, C. Diaconu ^{id}100, F.A. Dias ^{id}112, T. Dias Do Vale ^{id}127a, M.A. Diaz ^{id}134a,134b, F.G. Diaz Capriles ^{id}22, J. Dickinson ^{id}16a, M. Didenko ^{id}160, E.B. Diehl ^{id}104, J. Dietrich ^{id}17, S. Díez Cornell ^{id}46, C. Diez Pardos ^{id}139, A. Dimitrievska ^{id}16a, W. Ding ^{id}13b, J. Dingfelder ^{id}22, I-M. Dinu ^{id}25b, S.J. Dittmeier ^{id}61b, F. Dittus ^{id}34, F. Djama ^{id}100, T. Djobava ^{id}147b, J.I. Djuvsland ^{id}15, M.A.B. Do Vale ^{id}135, D. Dodsworth ^{id}24, C. Doglioni ^{id}95, J. Dolejsi ^{id}130, Z. Dolezal ^{id}130, M. Donadelli ^{id}79c, B. Dong ^{id}60c, J. Donini ^{id}38, A. D'Onofrio ^{id}13c, M. D'Onofrio ^{id}89, J. Dopke ^{id}131, A. Doria ^{id}69a, M.T. Dova ^{id}87, A.T. Doyle ^{id}57, E. Drechsler ^{id}140, E. Dreyer ^{id}140, T. Dreyer ^{id}53, A.S. Drobac ^{id}156, D. Du ^{id}60b, T.A. du Pree ^{id}112, F. Dubinin ^{id}35, M. Dubovsky ^{id}26a, A. Dubreuil ^{id}54, E. Duchovni ^{id}166, G. Duckeck ^{id}107, O.A. Ducu ^{id}34,25b, D. Duda ^{id}108, A. Dudarev ^{id}34, M. D'uffizi ^{id}99, L. Duflot ^{id}64, M. Dührssen ^{id}34, C. Dülsen ^{id}168, A.E. Dumitriu ^{id}25b, M. Dunford ^{id}61a, S. Dungs ^{id}47, K. Dunne ^{id}45a,45b, A. Duperrin ^{id}100, H. Duran Yildiz ^{id}3a, M. Düren ^{id}56, A. Durglishvili ^{id}147b, B. Dutta ^{id}46, B.L. Dwyer ^{id}113, G.I. Dyckes ^{id}125, M. Dyndal ^{id}82a, S. Dysch ^{id}99, B.S. Dziedzic ^{id}83, B. Eckerova ^{id}26a, M.G. Eggleston ^{id}49, E. Egidio Purcino De Souza ^{id}79b, L.F. Ehrke ^{id}54, T. Eifert ^{id}7, G. Eigen ^{id}15, K. Einsweiler ^{id}16a, T. Ekelof ^{id}158, Y. El Ghazali ^{id}33b, H. El Jarrari ^{id}33e, A. El Moussaouy ^{id}33a, V. Ellajosyula ^{id}158, M. Ellert ^{id}158, F. Ellinghaus ^{id}168, A.A. Elliot ^{id}91, N. Ellis ^{id}34, J. Elmsheuser ^{id}27, M. Elsing ^{id}34, D. Emelianov ^{id}131, A. Emerman ^{id}39, Y. Enari ^{id}151, J. Erdmann ^{id}47,al, A. Ereditato ^{id}18, P.A. Erland ^{id}83, M. Errenst ^{id}168, M. Escalier ^{id}64, C. Escobar ^{id}160, O. Estrada Pastor ^{id}160, E. Etzion ^{id}149, G. Evans ^{id}127a, H. Evans ^{id}65, M.O. Evans ^{id}144, A. Ezhilov ^{id}35,

F. Fabbri ⁵⁷, L. Fabbri ^{21b,21a}, V. Fabiani ¹¹¹, G. Facini ¹⁶⁴, V. Fadeyev ¹³³,
 R.M. Fakhruddinov ³⁵, S. Falciano ^{72a}, P.J. Falke ²², S. Falke ³⁴, J. Faltova ¹³⁰, Y. Fan ^{13a},
 Y. Fang ^{13a}, Y. Fang ^{13a,13d}, G. Fanourakis ⁴⁴, M. Fanti ^{68a,68b}, M. Faraj ^{60c}, A. Farbin ⁷,
 A. Farilla ^{74a}, E.M. Farina ^{70a,70b}, T. Farooque ¹⁰⁵, S.M. Farrington ⁵⁰, P. Farthouat ³⁴,
 F. Fassi ^{33e}, D. Fassouliotis ⁸, M. Faucci Giannelli ^{73a,73b}, W.J. Fawcett ³⁰, L. Fayard ⁶⁴,
 O.L. Fedin ^{35,a}, M. Feickert ¹⁵⁹, L. Feligioni ¹⁰⁰, A. Fell ¹³⁷, C. Feng ^{60b}, M. Feng ^{13b},
 M.J. Fenton ¹⁵⁷, A.B. Fenyuk ³⁵, S.W. Ferguson ⁴³, J. Ferrando ⁴⁶, A. Ferrari ¹⁵⁸, P. Ferrari ¹¹²,
 R. Ferrari ^{70a}, D. Ferrere ⁵⁴, C. Ferretti ¹⁰⁴, F. Fiedler ⁹⁸, A. Filipčič ⁹⁰, F. Filthaut ¹¹¹,
 M.C.N. Fiolhais ^{127a,127c,b}, L. Fiorini ¹⁶⁰, F. Fischer ¹³⁹, W.C. Fisher ¹⁰⁵, T. Fitschen ¹⁹,
 I. Fleck ¹³⁹, P. Fleischmann ¹⁰⁴, T. Flick ¹⁶⁸, B.M. Flierl ¹⁰⁷, L. Flores ¹²⁵,
 L.R. Flores Castillo ^{62a}, F.M. Follega ^{75a,75b}, N. Fomin ¹⁵, J.H. Foo ¹⁵³, B.C. Forland ⁶⁵,
 A. Formica ¹³², F.A. Förster ¹², A.C. Forti ⁹⁹, E. Fortin ¹⁰⁰, M.G. Foti ¹²³, D. Fournier ⁶⁴,
 H. Fox ⁸⁸, P. Francavilla ^{71a,71b}, S. Francescato ⁵⁹, M. Franchini ^{21b,21a}, S. Franchino ^{61a},
 D. Francis ³⁴, L. Franco ⁴, L. Franconi ¹⁸, M. Franklin ⁵⁹, G. Frattari ^{72a,72b}, A.C. Freegard ⁹¹,
 P.M. Freeman ¹⁹, W.S. Freund ^{79b}, E.M. Freundlich ⁴⁷, D. Froidevaux ³⁴, J.A. Frost ¹²³, Y. Fu ^{60a},
 M. Fujimoto ¹¹⁵, E. Fullana Torregrosa ^{160,*}, J. Fuster ¹⁶⁰, A. Gabrielli ^{21b,21a}, A. Gabrielli ³⁴,
 P. Gadow ⁴⁶, G. Gagliardi ^{55b,55a}, L.G. Gagnon ^{16a}, G.E. Gallardo ¹²³, E.J. Gallas ¹²³,
 B.J. Gallop ¹³¹, R. Gamboa Goni ⁹¹, K.K. Gan ¹¹⁶, S. Ganguly ¹⁶⁶, J. Gao ^{60a}, Y. Gao ⁵⁰,
 Y.S. Gao ^{29,o}, F.M. Garay Walls ^{134a}, C. García ¹⁶⁰, J.E. García Navarro ¹⁶⁰,
 J.A. García Pascual ^{13a}, M. Garcia-Sciveres ^{16a}, R.W. Gardner ³⁷, D. Garg ⁷⁷, S. Gargiulo ⁵²,
 C.A. Garner ¹⁵³, V. Garonne ¹²², S.J. Gasiorowski ¹³⁶, P. Gaspar ^{79b}, G. Gaudio ^{70a},
 P. Gauzzi ^{72a,72b}, I.L. Gavrilenko ³⁵, A. Gavrilyuk ³⁵, C. Gay ¹⁶¹, G. Gaycken ⁴⁶, E.N. Gazis ⁹,
 A.A. Geanta ^{25b}, C.M. Gee ¹³³, C.N.P. Gee ¹³¹, J. Geisen ⁹⁵, M. Geisen ⁹⁸, C. Gemme ^{55b},
 M.H. Genest ⁵⁸, S. Gentile ^{72a,72b}, S. George ⁹², W.F. George ¹⁹, T. Gerialis ⁴⁴, L.O. Gerlach ⁵³,
 P. Gessinger-Befurt ³⁴, M. Ghasemi Bostanabad ¹⁶², M. Ghneimat ¹³⁹, A. Ghosh ¹⁵⁷,
 A. Ghosh ⁷⁷, B. Giacobbe ^{21b}, S. Giagu ^{72a,72b}, N. Giangiacomi ¹⁵³, P. Giannetti ^{71a},
 A. Giannini ^{69a,69b}, S.M. Gibson ⁹², M. Gignac ¹³³, D.T. Gil ^{82b}, B.J. Gilbert ³⁹, D. Gillberg ³²,
 G. Gilles ¹¹², N.E.K. Gillwald ⁴⁶, D.M. Gingrich ^{2,ah}, M.P. Giordani ^{66a,66c}, P.F. Giraud ¹³²,
 G. Giugliarelli ^{66a,66c}, D. Giugni ^{68a}, F. Giuli ^{73a,73b}, I. Gkialas ^{8,j}, P. Gkoutoumis ⁹,
 L.K. Gladilin ³⁵, C. Glasman ⁹⁷, G.R. Gledhill ¹²⁰, M. Glisic ¹²⁰, I. Gnesi ^{41b,e},
 M. Goblirsch-Kolb ²⁴, D. Godin ¹⁰⁶, S. Goldfarb ¹⁰³, T. Golling ⁵⁴, D. Golubkov ³⁵,
 J.P. Gombas ¹⁰⁵, A. Gomes ^{127a,127b}, R. Goncalves Gama ⁵³, R. Gonçalves ^{127a,127c}, G. Gonella ¹²⁰,
 L. Gonella ¹⁹, A. Gongadze ³⁶, F. Gonnella ¹⁹, J.L. Gonski ³⁹, S. González de la Hoz ¹⁶⁰,
 S. Gonzalez Fernandez ¹², R. Gonzalez Lopez ⁸⁹, C. Gonzalez Renteria ^{16a},
 R. Gonzalez Suarez ¹⁵⁸, S. Gonzalez-Sevilla ⁵⁴, G.R. Gonzalvo Rodriguez ¹⁶⁰,
 R.Y. González Andana ^{134a}, L. Goossens ³⁴, N.A. Gorasia ¹⁹, P.A. Gorbounov ³⁵, B. Gorini ³⁴,
 E. Gorini ^{67a,67b}, A. Gorišek ⁹⁰, A.T. Goshaw ⁴⁹, M.I. Gostkin ³⁶, C.A. Gottardo ¹¹¹,
 M. Goughri ^{33b}, V. Goumarre ⁴⁶, A.G. Goussiou ¹³⁶, N. Govender ^{31c}, C. Goy ⁴,
 I. Grabowska-Bold ^{82a}, K. Graham ³², E. Gramstad ¹²², S. Grancagnolo ¹⁷, M. Grandi ¹⁴⁴,
 V. Gratchev ^{35,*}, P.M. Gravila ^{25f}, F.G. Gravili ^{67a,67b}, H.M. Gray ^{16a}, C. Grefe ²², I.M. Gregor ⁴⁶,
 P. Grenier ¹⁴¹, K. Grevtsov ⁴⁶, C. Grieco ¹², N.A. Grieser ¹¹⁷, A.A. Grillo ¹³³, K. Grimm ^{29,n},
 S. Grinstein ^{12,v}, J.-F. Grivaz ⁶⁴, S. Groh ⁹⁸, E. Gross ¹⁶⁶, J. Grosse-Knetter ⁵³, C. Grud ¹⁰⁴,
 A. Grummer ¹¹⁰, J.C. Grundy ¹²³, L. Guan ¹⁰⁴, W. Guan ¹⁶⁷, C. Gubbels ¹⁶¹, J. Guenther ³⁴,
 J.G.R. Guerrero Rojas ¹⁶⁰, F. Guescini ¹⁰⁸, R. Gugel ⁹⁸, A. Guida ⁴⁶, T. Guillemin ⁴,
 S. Guindon ³⁴, J. Guo ^{60c}, L. Guo ⁶⁴, Y. Guo ¹⁰⁴, R. Gupta ⁴⁶, S. Gurbuz ²², G. Gustavino ¹¹⁷,
 M. Guth ⁵⁴, P. Gutierrez ¹¹⁷, L.F. Gutierrez Zagazeta ¹²⁵, C. Gutschow ⁹³, C. Guyot ¹³²,
 C. Gwenlan ¹²³, C.B. Gwilliam ⁸⁹, E.S. Haaland ¹²², A. Haas ¹¹⁴, M. Habedank ¹⁷,

C. Haber ^{16a}, H.K. Hadavand ⁷, A. Hadeif ⁹⁸, S. Hadzic ¹⁰⁸, M. Haleem ¹⁶³, J. Haley ¹¹⁸,
 J.J. Hall ¹³⁷, G. Halladjian ¹⁰⁵, G.D. Hallewell ¹⁰⁰, L. Halser ¹⁸, K. Hamano ¹⁶²,
 H. Hamdaoui ^{33e}, M. Hamer ²², G.N. Hamity ⁵⁰, K. Han ^{60a}, L. Han ^{13c}, L. Han ^{60a},
 S. Han ^{16a}, Y.F. Han ¹⁵³, K. Hanagaki ⁸⁰, M. Hance ¹³³, M.D. Hank ³⁷, R. Hankache ⁹⁹,
 E. Hansen ⁹⁵, J.B. Hansen ⁴⁰, J.D. Hansen ⁴⁰, M.C. Hansen ²², P.H. Hansen ⁴⁰, K. Hara ¹⁵⁵,
 T. Harenberg ¹⁶⁸, S. Harkusha ³⁵, Y.T. Harris ¹²³, P.F. Harrison ¹⁶⁴, N.M. Hartman ¹⁴¹,
 N.M. Hartmann ¹⁰⁷, Y. Hasegawa ¹³⁸, A. Hasib ⁵⁰, S. Hassani ¹³², S. Haug ¹⁸, R. Hauser ¹⁰⁵,
 M. Havranek ¹²⁹, C.M. Hawkes ¹⁹, R.J. Hawkins ³⁴, S. Hayashida ¹⁰⁹, D. Hayden ¹⁰⁵,
 C. Hayes ¹⁰⁴, R.L. Hayes ¹⁶¹, C.P. Hays ¹²³, J.M. Hays ⁹¹, H.S. Hayward ⁸⁹, S.J. Haywood ¹³¹,
 F. He ^{60a}, Y. He ¹⁵², Y. He ¹²⁴, M.P. Heath ⁵⁰, V. Hedberg ⁹⁵, A.L. Heggelund ¹²²,
 N.D. Hehir ⁹¹, C. Heidegger ⁵², K.K. Heidegger ⁵², W.D. Heidorn ⁷⁸, J. Heilman ³²,
 S. Heim ⁴⁶, T. Heim ^{16a}, B. Heinemann ^{46,ae}, J.G. Heinlein ¹²⁵, J.J. Heinrich ¹²⁰, L. Heinrich ³⁴,
 J. Hejbal ¹²⁸, L. Helary ⁴⁶, A. Held ¹¹⁴, S. Hellesund ¹²², C.M. Helling ¹³³, S. Hellman ^{45a,45b},
 C. Helsens ³⁴, R.C.W. Henderson ⁸⁸, L. Henkelmann ³⁰, A.M. Henriques Correia ³⁴, H. Herde ¹⁴¹,
 Y. Hernández Jiménez ¹⁴³, H. Herr ⁹⁸, M.G. Herrmann ¹⁰⁷, T. Herrmann ⁴⁸, G. Herten ⁵²,
 R. Hertenberger ¹⁰⁷, L. Hervas ³⁴, N.P. Hesse ^{154a}, H. Hibi ⁸¹, S. Higashino ⁸⁰,
 E. Higón-Rodríguez ¹⁶⁰, K.K. Hill ²⁷, K.H. Hiller ⁴⁶, S.J. Hillier ¹⁹, M. Hils ⁴⁸, I. Hinchliffe ^{16a},
 F. Hinterkeuser ²², M. Hirose ¹²¹, S. Hirose ¹⁵⁵, D. Hirschbuehl ¹⁶⁸, B. Hiti ⁹⁰, O. Hladik ¹²⁸,
 J. Hobbs ¹⁴³, R. Hobincu ^{25e}, N. Hod ¹⁶⁶, M.C. Hodgkinson ¹³⁷, B.H. Hodgkinson ³⁰,
 A. Hoecker ³⁴, J. Hofer ⁴⁶, D. Hohn ⁵², T. Holm ²², T.R. Holmes ³⁷, M. Holzbock ¹⁰⁸,
 L.B.A.H. Hommels ³⁰, B.P. Honan ⁹⁹, J. Hong ^{60c}, T.M. Hong ¹²⁶, J.C. Honig ⁵², A. Hönle ¹⁰⁸,
 B.H. Hooberman ¹⁵⁹, W.H. Hopkins ⁵, Y. Horii ¹⁰⁹, L.A. Horyn ³⁷, S. Hou ¹⁴⁶, J. Howarth ⁵⁷,
 J. Hoya ⁸⁷, M. Hrabovsky ¹¹⁹, A. Hrynevich ³⁵, T. Hryn'ova ⁴, P.J. Hsu ⁶³, S.-C. Hsu ¹³⁶,
 Q. Hu ³⁹, S. Hu ^{60c}, Y.F. Hu ^{13a,13d,aj}, D.P. Huang ⁹³, X. Huang ^{13c}, Y. Huang ^{60a},
 Y. Huang ^{13a}, Z. Hubacek ¹²⁹, F. Hubaut ¹⁰⁰, M. Huebner ²², F. Huegging ²², T.B. Huffman ¹²³,
 M. Huhtinen ³⁴, R. Hulsken ⁵⁸, N. Huseynov ^{36,z}, J. Huston ¹⁰⁵, J. Huth ⁵⁹, R. Hyneman ¹⁴¹,
 S. Hyrych ^{26a}, G. Iacobucci ⁵⁴, G. Iakovidis ²⁷, I. Ibragimov ¹³⁹, L. Iconomidou-Fayard ⁶⁴,
 P. Iengo ³⁴, R. Iguchi ¹⁵¹, T. Iizawa ⁵⁴, Y. Ikegami ⁸⁰, A. Ilg ¹⁸, N. Ilic ¹⁵³, H. Imam ^{33a},
 T. Ingebretsen Carlson ^{45a,45b}, G. Introzzi ^{70a,70b}, M. Iodice ^{74a}, V. Ippolito ^{72a,72b}, M. Ishino ¹⁵¹,
 W. Islam ¹¹⁸, C. Issever ^{17,46}, S. Istin ^{11c,ak}, J.M. Iturbe Ponce ^{62a}, R. Iuppa ^{75a,75b}, A. Ivina ¹⁶⁶,
 J.M. Izen ⁴³, V. Izzo ^{69a}, P. Jacka ¹²⁸, P. Jackson ¹, R.M. Jacobs ⁴⁶, B.P. Jaeger ¹⁴⁰,
 C.S. Jagfeld ¹⁰⁷, G. Jäkel ¹⁶⁸, K. Jakobs ⁵², T. Jakoubek ¹⁶⁶, J. Jamieson ⁵⁷, K.W. Janas ^{82a},
 G. Jarlskog ⁹⁵, A.E. Jaspán ⁸⁹, N. Javadov ^{36,z}, T. Javůrek ³⁴, M. Javurkova ¹⁰¹, F. Jeanneau ¹³²,
 L. Jeanty ¹²⁰, J. Jejelava ^{147a,aa}, P. Jenni ^{52,f}, S. Jézéquel ⁴, J. Jia ¹⁴³, Z. Jia ^{13c}, Y. Jiang ^{60a},
 S. Jiggins ⁵², J. Jimenez Pena ¹⁰⁸, S. Jin ^{13c}, A. Jinaru ^{25b}, O. Jinnouchi ¹⁵², H. Jivan ^{31f},
 P. Johansson ¹³⁷, K.A. Johns ⁶, C.A. Johnson ⁶⁵, D.M. Jones ³⁰, E. Jones ¹⁶⁴, R.W.L. Jones ⁸⁸,
 T.J. Jones ⁸⁹, J. Jovicevic ⁵³, X. Ju ^{16a}, J.J. Junggeburch ³⁴, A. Juste Rozas ^{12,v}, S. Kabana ^{134d},
 A. Kaczmarzka ⁸³, M. Kado ^{72a,72b}, H. Kagan ¹¹⁶, M. Kagan ¹⁴¹, A. Kahn ³⁹, C. Kahra ⁹⁸,
 T. Kaji ¹⁶⁵, E. Kajomovitz ¹⁴⁸, C.W. Kalderon ²⁷, A. Kamenshchikov ³⁵, M. Kaneda ¹⁵¹,
 N.J. Kang ¹³³, S. Kang ⁷⁸, Y. Kano ¹⁰⁹, J. Kanzaki ⁸⁰, D. Kar ^{31f}, K. Karava ¹²³,
 M.J. Kareem ^{154b}, I. Karknias ¹⁵⁰, S.N. Karpov ³⁶, Z.M. Karpova ³⁶, V. Kartvelishvili ⁸⁸,
 A.N. Karyukhin ³⁵, E. Kasimi ¹⁵⁰, C. Kato ^{60d}, J. Katzy ⁴⁶, K. Kawade ¹³⁸, K. Kawagoe ⁸⁶,
 T. Kawaguchi ¹⁰⁹, T. Kawamoto ¹³², G. Kawamura ⁵³, E.F. Kay ¹⁶², F.I. Kaya ¹⁵⁶, S. Kazakos ¹²,
 V.F. Kazanin ³⁵, Y. Ke ¹⁴³, J.M. Keaveney ^{31a}, R. Keeler ¹⁶², J.S. Keller ³², D. Kelsey ¹⁴⁴,
 J.J. Kempster ¹⁹, J. Kendrick ¹⁹, K.E. Kennedy ³⁹, O. Kepka ¹²⁸, S. Kersten ¹⁶⁸,
 B.P. Kerševan ⁹⁰, S. Ketabchi Haghighat ¹⁵³, M. Khandoga ¹²⁴, A. Khanov ¹¹⁸,
 A.G. Kharlamov ³⁵, T. Kharlamova ³⁵, E.E. Khoda ¹³⁶, T.J. Khoo ¹⁷, G. Khoriali ¹⁶³,

J. Khubua ^{147b}, S. Kido ⁸¹, M. Kiehn ³⁴, A. Kilgallon ¹²⁰, E. Kim ¹⁵², Y.K. Kim ³⁷,
 N. Kimura ⁹³, A. Kirchhoff ⁵³, D. Kirchmeier ⁴⁸, C. Kirfel ²², J. Kirk ¹³¹, A.E. Kiryunin ¹⁰⁸,
 T. Kishimoto ¹⁵¹, D.P. Kisliuk ¹⁵³, V. Kitali ⁴⁶, C. Kitsaki ⁹, O. Kivernyk ²²,
 T. Klapdor-Kleingrothaus ⁵², M. Klassen ^{61a}, C. Klein ³², L. Klein ¹⁶³, M.H. Klein ¹⁰⁴,
 M. Klein ⁸⁹, U. Klein ⁸⁹, P. Klimek ³⁴, A. Klimentov ²⁷, F. Klimpel ³⁴, T. Klingl ²²,
 T. Klioutchnikova ³⁴, F.F. Klitzner ¹⁰⁷, P. Kluit ¹¹², S. Kluth ¹⁰⁸, E. Kneringer ⁷⁶,
 T.M. Knight ¹⁵³, A. Knue ⁵², D. Kobayashi ⁸⁶, M. Kobel ⁴⁸, M. Kocian ¹⁴¹, T. Kodama ¹⁵¹,
 P. Kodyš ¹³⁰, D.M. Koeck ¹⁴⁴, P.T. Koenig ²², T. Koffas ³², N.M. Köhler ³⁴, M. Kolb ¹³²,
 I. Koletsou ⁴, T. Komarek ¹¹⁹, K. Köneke ⁵², A.X.Y. Kong ¹, T. Kono ¹¹⁵, V. Konstantinides ⁹³,
 N. Konstantinidis ⁹³, B. Konya ⁹⁵, R. Kopeliansky ⁶⁵, S. Koperny ^{82a}, K. Korcyl ⁸³,
 K. Kordas ¹⁵⁰, G. Koren ¹⁴⁹, A. Korn ⁹³, S. Korn ⁵³, I. Korolkov ¹², E.V. Korolkova ¹³⁷,
 N. Korotkova ³⁵, B. Kortman ¹¹², O. Kortner ¹⁰⁸, S. Kortner ¹⁰⁸, W.H. Kostecka ¹¹³,
 V.V. Kostyukhin ^{137,35}, A. Kotsokechagia ⁶⁴, A. Kotwal ⁴⁹, A. Koulouris ³⁴,
 A. Kourkoumeli-Charalampidi ^{70a,70b}, C. Kourkoumelis ⁸, E. Kourlitis ⁵, O. Kovanda ¹⁴⁴,
 R. Kowalewski ¹⁶², W. Kozanecki ¹³², A.S. Kozhin ³⁵, V.A. Kramarenko ³⁵, G. Kramberger ⁹⁰,
 D. Krasnopevtsev ^{60a}, M.W. Krasny ¹²⁴, A. Krasznahorkay ³⁴, J.A. Kremer ⁹⁸, J. Kretzschmar ⁸⁹,
 K. Kreul ¹⁷, P. Krieger ¹⁵³, F. Krieter ¹⁰⁷, S. Krishnamurthy ¹⁰¹, A. Krishnan ^{61b},
 M. Krivos ¹³⁰, K. Krizka ^{16a}, K. Kroeninger ⁴⁷, H. Kroha ¹⁰⁸, J. Kroll ¹²⁸, J. Kroll ¹²⁵,
 K.S. Krowpman ¹⁰⁵, U. Kruchonak ³⁶, H. Krüger ²², N. Krumnack ⁷⁸, M.C. Kruse ⁴⁹,
 J.A. Krzysiak ⁸³, A. Kubota ¹⁵², O. Kuchinskaia ³⁵, S. Kuday ^{3b}, D. Kuechler ⁴⁶,
 J.T. Kuechler ⁴⁶, S. Kuehn ³⁴, T. Kuhl ⁴⁶, V. Kukhtin ³⁶, Y. Kulchitsky ^{35,a}, S. Kuleshov ^{134c},
 M. Kumar ^{31f}, N. Kumari ¹⁰⁰, M. Kuna ⁵⁸, A. Kupco ¹²⁸, T. Kupfer ⁴⁷, O. Kuprash ⁵²,
 H. Kurashige ⁸¹, L.L. Kurchaninov ^{154a}, Y.A. Kurochkin ³⁵, A. Kurova ³⁵, M.G. Kurth ^{13a,13d},
 E.S. Kuwertz ³⁴, M. Kuze ¹⁵², A.K. Kvam ¹³⁶, J. Kvita ¹¹⁹, T. Kwan ¹⁰², K.W. Kwok ^{62a},
 C. Lacasta ¹⁶⁰, F. Lacava ^{72a,72b}, H. Lacker ¹⁷, D. Lacour ¹²⁴, N.N. Lad ⁹³, E. Ladygin ³⁶,
 R. Lafaye ⁴, B. Laforge ¹²⁴, T. Lagouri ^{134d}, S. Lai ⁵³, I.K. Lakomic ^{82a}, N. Lalloue ⁵⁸,
 J.E. Lambert ¹¹⁷, S. Lammers ⁶⁵, W. Lampl ⁶, C. Lampoudis ¹⁵⁰, E. Lançon ²⁷, U. Landgraf ⁵²,
 M.P.J. Landon ⁹¹, V.S. Lang ⁵², J.C. Lange ⁵³, R.J. Langenberg ¹⁰¹, A.J. Lankford ¹⁵⁷,
 F. Lanni ²⁷, K. Lantzsch ²², A. Lanza ^{70a}, A. Lapertosa ^{55b,55a}, J.F. Laporte ¹³², T. Lari ^{68a},
 F. Lasagni Manghi ^{21b}, M. Lassnig ³⁴, V. Latonova ¹²⁸, T.S. Lau ^{62a}, A. Laudrain ⁹⁸,
 A. Laurier ³², M. Lavorgna ^{69a,69b}, S.D. Lawlor ⁹², Z. Lawrence ⁹⁹, M. Lazzaroni ^{68a,68b}, B. Le ⁹⁹,
 B. Leban ⁹⁰, A. Lebedev ⁷⁸, M. LeBlanc ³⁴, T. LeCompte ⁵, F. Ledroit-Guillon ⁵⁸, A.C.A. Lee ⁹³,
 G.R. Lee ¹⁵, L. Lee ⁵⁹, S.C. Lee ¹⁴⁶, S. Lee ⁷⁸, L.L. Leeuw ^{31c}, B. Lefebvre ^{154a},
 H.P. Lefebvre ⁹², M. Lefebvre ¹⁶², C. Leggett ^{16a}, K. Lehmann ¹⁴⁰, N. Lehmann ¹⁸,
 G. Lehmann Miotto ³⁴, W.A. Leight ⁴⁶, A. Leisos ^{150,u}, M.A.L. Leite ^{79c}, C.E. Leitgeb ⁴⁶,
 R. Leitner ¹³⁰, K.J.C. Leney ⁴², T. Lenz ²², S. Leone ^{71a}, C. Leonidopoulos ⁵⁰, A. Leopold ¹²⁴,
 C. Leroy ¹⁰⁶, R. Les ¹⁰⁵, C.G. Lester ³⁰, M. Levchenko ³⁵, J. Levêque ⁴, D. Levin ¹⁰⁴,
 L.J. Levinson ¹⁶⁶, D.J. Lewis ¹⁹, B. Li ^{13b}, B. Li ^{60b}, C. Li ^{60a}, C-Q. Li ^{60c,60d}, H. Li ^{60a},
 H. Li ^{60b}, H. Li ^{60b}, J. Li ^{60c}, K. Li ¹³⁶, L. Li ^{60c}, M. Li ^{13a,13d}, Q.Y. Li ^{60a}, S. Li ^{60d,60c,d},
 T. Li ^{60b}, X. Li ⁴⁶, Y. Li ⁴⁶, Z. Li ^{60b}, Z. Li ¹²³, Z. Li ¹⁰², Z. Li ⁸⁹, Z. Liang ^{13a},
 M. Liberatore ⁴⁶, B. Liberti ^{73a}, K. Lie ^{62c}, K. Lin ¹⁰⁵, R.A. Linck ⁶⁵, R.E. Lindley ⁶,
 J.H. Lindon ², A. Linss ⁴⁶, E. Lipeles ¹²⁵, A. Lipniacka ¹⁵, T.M. Liss ^{159,af}, A. Lister ¹⁶¹,
 J.D. Little ⁷, B. Liu ^{13a}, B.X. Liu ¹⁴⁰, J.B. Liu ^{60a}, J.K.K. Liu ³⁷, K. Liu ^{60d,60c}, M. Liu ^{60a},
 M.Y. Liu ^{60a}, P. Liu ^{13a}, X. Liu ^{60a}, Y. Liu ⁴⁶, Y. Liu ^{13c,13d}, Y.L. Liu ¹⁰⁴, Y.W. Liu ^{60a},
 M. Livan ^{70a,70b}, A. Lleres ⁵⁸, J. Llorente Merino ¹⁴⁰, S.L. Lloyd ⁹¹, E.M. Lobodzinska ⁴⁶,
 P. Loch ⁶, S. Loffredo ^{73a,73b}, T. Lohse ¹⁷, K. Lohwasser ¹³⁷, M. Lokajicek ¹²⁸, J.D. Long ¹⁵⁹,
 I. Longarini ^{72a,72b}, L. Longo ³⁴, R. Longo ¹⁵⁹, I. Lopez Paz ¹², A. Lopez Solis ⁴⁶,

J. Lorenz [id107](#), N. Lorenzo Martinez [id4](#), A.M. Lory [id107](#), A. Lösle [id52](#), X. Lou [id45a,45b](#), X. Lou [id13a,13d](#), A. Lounis [id64](#), J. Love [id5](#), P.A. Love [id88](#), J.J. Lozano Bahilo [id160](#), G. Lu [id13a,13d](#), M. Lu [id60a](#), S. Lu [id125](#), Y.J. Lu [id63](#), H.J. Lubatti [id136](#), C. Luci [id72a,72b](#), F.L. Lucio Alves [id13c](#), A. Lucotte [id58](#), F. Luehring [id65](#), I. Luise [id143](#), L. Luminari [id72a](#), O. Lundberg [id142](#), B. Lund-Jensen [id142](#), N.A. Luongo [id120](#), M.S. Lutz [id149](#), D. Lynn [id27](#), H. Lyons [id89](#), R. Lysak [id128](#), E. Lytken [id95](#), F. Lyu [id13a](#), V. Lyubushkin [id36](#), T. Lyubushkina [id36](#), H. Ma [id27](#), L.L. Ma [id60b](#), Y. Ma [id93](#), D.M. Mac Donell [id162](#), G. Maccarrone [id51](#), C.M. Macdonald [id137](#), J.C. MacDonald [id137](#), R. Madar [id38](#), W.F. Mader [id48](#), M. Madugoda Ralalage Don [id118](#), N. Madysa [id48](#), J. Maeda [id81](#), T. Maeno [id27](#), M. Maerker [id48](#), V. Magerl [id52](#), J. Magro [id66a,66c](#), D.J. Mahon [id39](#), C. Maidantchik [id79b](#), A. Maio [id127a,127b,127d](#), K. Maj [id82a](#), O. Majersky [id26a](#), S. Majewski [id120](#), N. Makovec [id64](#), B. Malaescu [id124](#), Pa. Malecki [id83](#), V.P. Maleev [id35](#), F. Malek [id58](#), D. Malito [id41b,41a](#), U. Mallik [id77](#), C. Malone [id30](#), S. Maltezos [id9](#), S. Malyukov [id36](#), J. Mamuzic [id160](#), G. Mancini [id51](#), J.P. Mandalia [id91](#), I. Mandić [id90](#), L. Manhaes de Andrade Filho [id79a](#), I.M. Maniatis [id150](#), M. Manisha [id132](#), J. Manjarres Ramos [id48](#), K.H. Mankinen [id95](#), A. Mann [id107](#), A. Manousos [id76](#), B. Mansoulie [id132](#), I. Manthos [id150](#), S. Manzoni [id112](#), A. Marantis [id150,u](#), G. Marchiori [id124](#), M. Marcisovsky [id128](#), L. Marcoccia [id73a,73b](#), C. Marcon [id95](#), M. Marjanovic [id117](#), Z. Marshall [id16a](#), S. Marti-Garcia [id160](#), T.A. Martin [id164](#), V.J. Martin [id50](#), B. Martin dit Latour [id15](#), L. Martinelli [id72a,72b](#), M. Martinez [id12,v](#), P. Martinez Agullo [id160](#), V.I. Martinez Outschoorn [id101](#), S. Martin-Haugh [id131](#), V.S. Martoiu [id25b](#), A.C. Martyniuk [id93](#), A. Marzin [id34](#), S.R. Maschek [id108](#), L. Masetti [id98](#), T. Mashimo [id151](#), J. Masik [id99](#), A.L. Maslennikov [id35](#), L. Massa [id21b](#), P. Massarotti [id69a,69b](#), P. Mastrandrea [id71a,71b](#), A. Mastroberardino [id41b,41a](#), T. Masubuchi [id151](#), D. Matakias [id27](#), T. Mathisen [id158](#), A. Matic [id107](#), N. Matsuzawa [id151](#), J. Maurer [id25b](#), B. Maček [id90](#), D.A. Maximov [id35](#), R. Mazini [id146](#), I. Maznas [id150](#), S.M. Mazza [id133](#), C. Mc Ginn [id27](#), J.P. Mc Gowan [id102](#), S.P. Mc Kee [id104](#), T.G. McCarthy [id108](#), W.P. McCormack [id16a](#), E.F. McDonald [id103](#), A.E. McDougall [id112](#), J.A. Mcfayden [id144](#), G. Mchedlize [id147b](#), M.A. McKay [id42](#), K.D. McLean [id162](#), S.J. McMahon [id131](#), P.C. McNamara [id103](#), R.A. McPherson [id162,y](#), J.E. Mdhluli [id31f](#), Z.A. Meadows [id101](#), S. Meehan [id34](#), T. Megy [id38](#), S. Mehlhase [id107](#), A. Mehta [id89](#), B. Meirose [id43](#), D. Melini [id148](#), B.R. Mellado Garcia [id31f](#), A.H. Melo [id53](#), F. Meloni [id46](#), A. Melzer [id22](#), E.D. Mendes Gouveia [id127a](#), A.M. Mendes Jacques Da Costa [id19](#), H.Y. Meng [id153](#), L. Meng [id34](#), S. Menke [id108](#), M. Mentink [id34](#), E. Meoni [id41b,41a](#), C. Merlassino [id123](#), P. Mermoud [id54,*](#), L. Merola [id69a,69b](#), C. Meroni [id68a](#), G. Merz [id104](#), O. Meshkov [id35](#), J.K.R. Meshreki [id139](#), J. Metcalfe [id5](#), A.S. Mete [id5](#), C. Meyer [id65](#), J-P. Meyer [id132](#), M. Michetti [id17](#), R.P. Middleton [id131](#), L. Mijović [id50](#), G. Mikenberg [id166](#), M. Mikestikova [id128](#), M. Mikuž [id90](#), H. Mildner [id137](#), A. Milic [id153](#), C.D. Milke [id42](#), D.W. Miller [id37](#), L.S. Miller [id32](#), A. Milov [id166](#), D.A. Milstead [id45a,45b](#), T. Min [id13c](#), A.A. Minaenko [id35](#), I.A. Minashvili [id147b](#), L. Mince [id57](#), A.I. Mincer [id114](#), B. Mindur [id82a](#), M. Mineev [id36](#), Y. Minegishi [id151](#), Y. Mino [id84](#), L.M. Mir [id12](#), M. Miralles Lopez [id160](#), M. Mironova [id123](#), T. Mitani [id165](#), V.A. Mitsou [id160](#), M. Mittal [id160c](#), O. Miu [id153](#), P.S. Miyagawa [id91](#), Y. Miyazaki [id86](#), A. Mizukami [id80](#), J.U. Mjörnmark [id95](#), T. Mkrtchyan [id61a](#), M. Mlynarikova [id113](#), T. Moa [id45a,45b](#), S. Mobius [id53](#), K. Mochizuki [id106](#), P. Moder [id46](#), P. Mogg [id107](#), A.F. Mohammed [id13a,13d](#), S. Mohapatra [id39](#), G. Mokgatitwane [id31f](#), B. Mondal [id139](#), S. Mondal [id129](#), K. Mönig [id46](#), E. Monnier [id100](#), A. Montalbano [id140](#), J. Montejo Berlingen [id34](#), M. Montella [id116](#), F. Monticelli [id87](#), N. Morange [id64](#), A.L. Moreira De Carvalho [id127a](#), M. Moreno Llácer [id160](#), C. Moreno Martinez [id12](#), P. Morettini [id55b](#), M. Morgenstern [id148](#), S. Morgenstern [id164](#), D. Mori [id140](#), M. Morii [id59](#), M. Morinaga [id151](#), V. Morisbak [id122](#), A.K. Morley [id34](#), A.P. Morris [id93](#), L. Morvaj [id34](#), P. Moschovakos [id34](#), B. Moser [id112](#), M. Mosidze [id147b](#), T. Moskalets [id52](#), P. Moskvitina [id111](#), J. Moss [id29,p](#), E.J.W. Moyses [id101](#), S. Muanza [id100](#), J. Mueller [id126](#), D. Muenstermann [id88](#), R. Müller [id18](#), G.A. Mullier [id95](#), J.J. Mullin [id125](#), D.P. Mungo [id68a,68b](#), J.L. Munoz Martinez [id12](#), F.J. Munoz Sanchez [id99](#), M. Murin [id99](#), P. Murin [id26b](#), W.J. Murray [id164,131](#), A. Murrone [id68a,68b](#),

J.M. Muse ¹¹⁷, M. Muškinja ^{16a}, C. Mwewa ²⁷, A.G. Myagkov ^{35,a}, A.J. Myers ⁷, A.A. Myers ¹²⁶, G. Myers ⁶⁵, M. Myska ¹²⁹, B.P. Nachman ^{16a}, O. Nackenhorst ⁴⁷, A.Nag Nag ⁴⁸, K. Nagai ¹²³, K. Nagano ⁸⁰, J.L. Nagle ²⁷, E. Nagy ¹⁰⁰, A.M. Nairz ³⁴, Y. Nakahama ¹⁰⁹, K. Nakamura ⁸⁰, H. Nanjo ¹²¹, F. Napolitano ^{61a}, R. Narayan ⁴², I. Naryshkin ³⁵, M. Naseri ³², C. Nass ²², T. Naumann ⁴⁶, G. Navarro ^{20a}, J. Navarro-Gonzalez ¹⁶⁰, R. Nayak ¹⁴⁹, P.Y. Nechaeva ³⁵, F. Nechansky ⁴⁶, T.J. Neep ¹⁹, A. Negri ^{70a,70b}, M. Negrini ^{21b}, C. Nellist ¹¹¹, C. Nelson ¹⁰², K. Nelson ¹⁰⁴, S. Nemecek ¹²⁸, M. Nessi ^{34,h}, M.S. Neubauer ¹⁵⁹, F. Neuhaus ⁹⁸, J. Neundorf ⁴⁶, R. Newhouse ¹⁶¹, P.R. Newman ¹⁹, C.W. Ng ¹²⁶, Y.S. Ng ¹⁷, Y.W.Y. Ng ¹⁵⁷, B. Ngair ^{33e}, H.D.N. Nguyen ¹⁰⁰, R.B. Nickerson ¹²³, R. Nicolaidou ¹³², D.S. Nielsen ⁴⁰, J. Nielsen ¹³³, M. Niemeyer ⁵³, N. Nikiforou ¹⁰, V. Nikolaenko ^{35,a}, I. Nikolic-Audit ¹²⁴, K. Nikolopoulos ¹⁹, P. Nilsson ²⁷, H.R. Nindhito ⁵⁴, A. Nisati ^{72a}, N. Nishu ², R. Nisius ¹⁰⁸, T. Nitta ¹⁶⁵, T. Nobe ¹⁵¹, D.L. Noel ³⁰, Y. Noguchi ⁸⁴, I. Nomidis ¹²⁴, M.A. Nomura ²⁷, M.B. Norfolk ¹³⁷, R.R.B. Norisam ⁹³, J. Novak ⁹⁰, T. Novak ⁴⁶, O. Novgorodova ⁴⁸, L. Novotny ¹²⁹, R. Novotny ¹¹⁰, L. Nozka ¹¹⁹, K. Ntekas ¹⁵⁷, E. Nurse ⁹³, F.G. Oakham ^{32,ah}, J. Ocariz ¹²⁴, A. Ochi ⁸¹, I. Ochoa ^{127a}, J.P. Ochoa-Ricoux ^{134a}, S. Oda ⁸⁶, S. Odaka ⁸⁰, S. Oerdek ¹⁵⁸, A. Ogrodnik ^{82a}, A. Oh ⁹⁹, C.C. Ohm ¹⁴², H. Oide ¹⁵², R. Oishi ¹⁵¹, M.L. Ojeda ¹⁵³, Y. Okazaki ⁸⁴, M.W. O’Keefe ⁸⁹, Y. Okumura ¹⁵¹, A. Olariu ^{25b}, L.F. Oleiro Seabra ^{127a}, S.A. Olivares Pino ^{134d}, D. Oliveira Damazio ²⁷, D. Oliveira Goncalves ^{79a}, J.L. Oliver ¹⁵⁷, M.J.R. Olsson ¹⁵⁷, A. Olszewski ⁸³, J. Olszowska ^{83,*}, Ö.O. Öncel ²², D.C. O’Neil ¹⁴⁰, A.P. O’Neill ¹²³, A. Onofre ^{127a,127e}, P.U.E. Onyisi ¹⁰, R.G. Oreamuno Madriz ¹¹³, M.J. Oreglia ³⁷, G.E. Orellana ⁸⁷, D. Orestano ^{74a,74b}, N. Orlando ¹², R.S. Orr ¹⁵³, V. O’Shea ⁵⁷, R. Ospanov ^{60a}, G. Otero y Garzon ²⁸, H. Otono ⁸⁶, P.S. Ott ^{61a}, G.J. Ottino ^{16a}, M. Ouchrif ^{33d}, J. Ouellette ²⁷, F. Ould-Saada ¹²², A. Ouraou ^{132,*}, Q. Ouyang ^{13a}, M. Owen ⁵⁷, R.E. Owen ¹³¹, K.Y. Oyulmaz ^{11c}, V.E. Ozcan ^{11c}, N. Ozturk ⁷, S. Ozturk ^{11c}, J. Pacalt ¹¹⁹, H.A. Pacey ³⁰, K. Pachal ⁴⁹, A. Pacheco Pages ¹², C. Padilla Aranda ¹², S. Pagan Griso ^{16a}, G. Palacino ⁶⁵, S. Palazzo ⁵⁰, S. Palestini ³⁴, M. Palka ^{82b}, P. Palni ^{82a}, D.K. Panchal ¹⁰, C.E. Pandini ⁵⁴, J.G. Panduro Vazquez ⁹², P. Pani ⁴⁶, G. Panizzo ^{66a,66c}, L. Paolozzi ⁵⁴, C. Papadatos ¹⁰⁶, S. Parajuli ⁴², A. Paramonov ⁵, C. Paraskevopoulos ⁹, D. Paredes Hernandez ^{62b}, S.R. Paredes Saenz ¹²³, B. Parida ¹⁶⁶, T.H. Park ¹⁵³, A.J. Parker ²⁹, M.A. Parker ³⁰, F. Parodi ^{55b,55a}, E.W. Parrish ¹¹³, J.A. Parsons ³⁹, U. Parzefall ⁵², L. Pascual Dominguez ¹⁴⁹, V.R. Pascuzzi ^{16a}, F. Pasquali ¹¹², E. Pasqualucci ^{72a}, S. Passaggio ^{55b}, F. Pastore ⁹², P. Pasuwan ^{45a,45b}, J.R. Pater ⁹⁹, A. Pathak ¹⁶⁷, J. Patton ⁸⁹, T. Pauly ³⁴, J. Pearkes ¹⁴¹, M. Pedersen ¹²², L. Pedraza Diaz ¹¹¹, R. Pedro ^{127a}, T. Peiffer ⁵³, S.V. Peleganchuk ³⁵, O. Penc ¹²⁸, C. Peng ^{62b}, H. Peng ^{60a}, M. Penzin ³⁵, B.S. Peralva ^{79a}, M.M. Perego ⁶⁴, A.P. Pereira Peixoto ^{127a}, L. Pereira Sanchez ^{45a,45b}, D.V. Perepelitsa ²⁷, E. Perez Codina ^{154a}, M. Perganti ⁹, L. Perini ^{68a,68b,*}, H. Pernegger ³⁴, S. Perrella ³⁴, A. Perrevoort ¹¹², K. Peters ⁴⁶, R.F.Y. Peters ⁹⁹, B.A. Petersen ³⁴, T.C. Petersen ⁴⁰, E. Petit ¹⁰⁰, V. Petousis ¹²⁹, C. Petridou ¹⁵⁰, P. Petroff ⁶⁴, F. Petrucci ^{74a,74b}, M. Pettee ¹⁶⁹, N.E. Pettersson ³⁴, K. Petukhova ¹³⁰, A. Peyaud ¹³², R. Pezoa ^{134e}, L. Pezzotti ³⁴, G. Pezzullo ¹⁶⁹, T. Pham ¹⁰³, P.W. Phillips ¹³¹, M.W. Phipps ¹⁵⁹, G. Piacquadio ¹⁴³, E. Pianori ^{16a}, F. Piazza ^{68a,68b}, A. Picazio ¹⁰¹, R. Piegai ²⁸, D. Pietreanu ^{25b}, J.E. Pilcher ³⁷, A.D. Pilkington ⁹⁹, M. Pinamonti ^{66a,66c}, J.L. Pinfold ², C. Pitman Donaldson ⁹³, D.A. Pizzi ³², L. Pizzimento ^{73a,73b}, A. Pizzini ¹¹², M.-A. Pleier ²⁷, V. Plesanovs ⁵², V. Pleskot ¹³⁰, E. Plotnikova ³⁶, P. Podberczko ³⁵, R. Poettgen ⁹⁵, R. Poggi ⁵⁴, L. Poggioli ¹²⁴, I. Pogrebnyak ¹⁰⁵, D. Pohl ²², I. Pokharel ⁵³, G. Polesello ^{70a}, A. Poley ^{140,154a}, A. Policicchio ^{72a,72b}, R. Polifka ¹³⁰, A. Polini ^{21b}, C.S. Pollard ¹²³, Z.B. Pollock ¹¹⁶, V. Polychronakos ²⁷, D. Ponomarenko ³⁵, L. Pontecorvo ³⁴, S. Popa ^{25a}, G.A. Popeneciu ^{25d}, L. Portales ⁴, D.M. Portillo Quintero ^{154a}, S. Pospisil ¹²⁹, P. Postolache ^{25c}, K. Potamianos ¹²³,

I.N. Potrap [ID36](#), C.J. Potter [ID30](#), H. Potti [ID1](#), T. Poulsen [ID46](#), J. Poveda [ID160](#), T.D. Powell [ID137](#),
 G. Pownall [ID46](#), M.E. Pozo Astigarraga [ID34](#), A. Prades Ibanez [ID160](#), P. Pralavorio [ID100](#), M.M. Prapa [ID44](#),
 S. Prell [ID78](#), D. Price [ID99](#), M. Primavera [ID67a](#), M.A. Principe Martin [ID97](#), M.L. Proffitt [ID136](#),
 N. Proklova [ID35](#), K. Prokofiev [ID62c](#), S. Protopopescu [ID27](#), J. Proudfoot [ID5](#), M. Przybycien [ID82a](#),
 D. Pudzha [ID35](#), P. Puzo [ID64](#), D. Pyatiizbyantseva [ID35](#), J. Qian [ID104](#), Y. Qin [ID99](#), T. Qiu [ID91](#), A. Quadt [ID53](#),
 M. Queitsch-Maitland [ID34](#), G. Rabanal Bolanos [ID59](#), F. Ragusa [ID68a,68b](#), G. Rahal [ID96](#), J.A. Raine [ID54](#),
 S. Rajagopalan [ID27](#), K. Ran [ID13a,13d](#), D.F. Rassloff [ID61a](#), D.M. Rauch [ID46](#), S. Rave [ID98](#), B. Ravina [ID57](#),
 I. Ravinovich [ID166](#), M. Raymond [ID34](#), A.L. Read [ID122](#), N.P. Readioff [ID137](#), D.M. Rebutti [ID70a,70b](#),
 G. Redlinger [ID27](#), K. Reeves [ID43](#), D. Reikher [ID149](#), A. Reiss [ID98](#), A. Rej [ID139](#), C. Rembser [ID34](#),
 A. Renardi [ID46](#), M. Renda [ID25b](#), M.B. Rendel [ID108](#), A.G. Rennie [ID57](#), S. Resconi [ID68a](#), E.D. Resseguie [ID16a](#),
 S. Rettie [ID93](#), B. Reynolds [ID116](#), E. Reynolds [ID19](#), M. Rezaei Estabragh [ID168](#), O.L. Rezanova [ID35](#),
 P. Reznicek [ID130](#), E. Ricci [ID75a,75b](#), R. Richter [ID108](#), S. Richter [ID46](#), E. Richter-Was [ID82b](#), M. Ridel [ID124](#),
 P. Rieck [ID108](#), P. Riedler [ID34](#), O. Rifki [ID46](#), M. Rijssenbeek [ID143](#), A. Rimoldi [ID70a,70b](#), M. Rimoldi [ID46](#),
 L. Rinaldi [ID21b,21a](#), T.T. Rinn [ID159](#), M.P. Rinnagel [ID107](#), G. Ripellino [ID142](#), I. Riu [ID12](#), P. Rivadeneira [ID46](#),
 J.C. Rivera Vergara [ID162](#), F. Rizatdinova [ID118](#), E. Rizvi [ID91](#), C. Rizzi [ID54](#), B.A. Roberts [ID164](#),
 S.H. Robertson [ID102,y](#), M. Robin [ID46](#), D. Robinson [ID30](#), C.M. Robles Gajardo [ID134e](#),
 M. Robles Manzano [ID98](#), A. Robson [ID57](#), A. Rocchi [ID73a,73b](#), C. Roda [ID71a,71b](#), S. Rodriguez Bosca [ID61a](#),
 A. Rodriguez Rodriguez [ID52](#), A.M. Rodríguez Vera [ID154b](#), S. Roe [ID34](#), A.R. Roepe-Gier [ID117](#),
 J. Roggel [ID168](#), O. Röhne [ID122](#), R.A. Rojas [ID134e](#), B. Roland [ID52](#), C.P.A. Roland [ID65](#), J. Roloff [ID27](#),
 A. Romaniouk [ID35](#), M. Romano [ID21b](#), A.C. Romero Hernandez [ID159](#), N. Rompotis [ID89](#), M. Ronzani [ID114](#),
 L. Roos [ID124](#), S. Rosati [ID72a](#), B.J. Rosser [ID125](#), E. Rossi [ID153](#), E. Rossi [ID4](#), E. Rossi [ID69a,69b](#),
 L.P. Rossi [ID55b](#), L. Rossini [ID46](#), R. Rosten [ID116](#), M. Rotaru [ID25b](#), B. Rottler [ID52](#), D. Rousseau [ID64](#),
 D. Rousso [ID30](#), G. Rovelli [ID70a,70b](#), A. Roy [ID10](#), A. Rozanov [ID100](#), Y. Rozen [ID148](#), X. Ruan [ID31f](#),
 A.J. Ruby [ID89](#), T.A. Ruggeri [ID1](#), F. Rühr [ID52](#), A. Ruiz-Martinez [ID160](#), A. Rummler [ID34](#), Z. Rurikova [ID52](#),
 N.A. Rusakovich [ID36](#), H.L. Russell [ID34](#), L. Rustige [ID38](#), J.P. Rutherford [ID6](#), E.M. Rüttinger [ID137](#),
 M. Rybar [ID130](#), E.B. Rye [ID122](#), A. Ryzhov [ID35](#), J.A. Sabater Iglesias [ID46](#), P. Sabatini [ID160](#),
 L. Sabetta [ID72a,72b](#), H.F-W. Sadrozinski [ID133](#), F. Safai Tehrani [ID72a](#), B. Safarzadeh Samani [ID144](#),
 M. Safdari [ID141](#), P. Saha [ID113](#), S. Saha [ID102](#), M. Sahinsoy [ID108](#), A. Sahu [ID168](#), M. Saimpert [ID132](#),
 M. Saito [ID151](#), T. Saito [ID151](#), D. Salamani [ID34](#), G. Salamanna [ID74a,74b](#), A. Salnikov [ID141](#), J. Salt [ID160](#),
 A. Salvador Salas [ID12](#), D. Salvatore [ID41b,41a](#), F. Salvatore [ID144](#), A. Salzburger [ID34](#), D. Sammel [ID52](#),
 D. Sampsonidis [ID150](#), D. Sampsonidou [ID60d,60c](#), J. Sánchez [ID160](#), A. Sanchez Pineda [ID4](#),
 V. Sanchez Sebastian [ID160](#), H. Sandaker [ID122](#), C.O. Sander [ID46](#), I.G. Sanderswood [ID88](#),
 J.A. Sandesara [ID101](#), M. Sandhoff [ID168](#), C. Sandoval [ID20b](#), D.P.C. Sankey [ID131](#), M. Sannino [ID55b,55a](#),
 Y. Sano [ID109](#), A. Sansoni [ID51](#), C. Santoni [ID38](#), H. Santos [ID127a,127b](#), S.N. Santpur [ID16a](#), A. Santra [ID166](#),
 K.A. Saoucha [ID137](#), J.G. Saraiva [ID127a,127d](#), J. Sardain [ID100](#), O. Sasaki [ID80](#), K. Sato [ID155](#), C. Sauer [ID61b](#),
 F. Sauerburger [ID52](#), E. Sauvan [ID4](#), P. Savard [ID153,ah](#), R. Sawada [ID151](#), C. Sawyer [ID131](#), L. Sawyer [ID94](#),
 I. Sayago Galvan [ID160](#), C. Sbarra [ID21b](#), A. Sbrizzi [ID66a,66c](#), T. Scanlon [ID93](#), J. Schaarschmidt [ID136](#),
 P. Schacht [ID108](#), D. Schaefer [ID37](#), U. Schäfer [ID98](#), A.C. Schaffer [ID64](#), D. Schaile [ID107](#),
 R.D. Schamberger [ID143](#), E. Schanet [ID107](#), C. Scharf [ID17](#), N. Scharmberg [ID99](#), V.A. Schegelsky [ID35](#),
 D. Scheirich [ID130](#), F. Schenck [ID17](#), M. Schernau [ID157](#), C. Schiavi [ID55b,55a](#), L.K. Schildgen [ID22](#),
 Z.M. Schillaci [ID24](#), E.J. Schioppa [ID67a,67b](#), M. Schioppa [ID41b,41a](#), B. Schlag [ID98](#), K.E. Schleicher [ID52](#),
 S. Schlenker [ID34](#), K. Schmieden [ID98](#), C. Schmitt [ID98](#), S. Schmitt [ID46](#), L. Schoeffel [ID132](#),
 A. Schoening [ID51b](#), P.G. Scholer [ID52](#), E. Schopf [ID123](#), M. Schott [ID98](#), J. Schovancova [ID34](#),
 S. Schramm [ID54](#), F. Schroeder [ID168](#), H-C. Schultz-Coulon [ID61a](#), M. Schumacher [ID52](#), B.A. Schumm [ID133](#),
 Ph. Schune [ID132](#), A. Schwartzman [ID141](#), T.A. Schwarz [ID104](#), Ph. Schwemling [ID132](#), R. Schwienhorst [ID105](#),
 A. Sciandra [ID133](#), G. Sciolla [ID24](#), F. Scuri [ID71a](#), F. Scutti [ID103](#), C.D. Sebastiani [ID89](#), K. Sedlaczek [ID47](#),
 P. Seema [ID17](#), S.C. Seidel [ID110](#), A. Seiden [ID133](#), B.D. Seidlitz [ID27](#), T. Seiss [ID37](#), C. Seitz [ID46](#),

J.M. Seixas ^{79b}, G. Sekhniaidze ^{69a}, S.J. Sekula ⁴², L. Selem ⁴, N. Semprini-Cesari ^{21b,21a}, S. Sen ⁴⁹, C. Serfon ²⁷, L. Serin ⁶⁴, L. Serkin ^{66a,66b}, M. Sessa ^{74a,74b}, H. Severini ¹¹⁷, S. Sevova ¹⁴¹, F. Sforza ^{55b,55a}, A. Sfyrla ⁵⁴, E. Shabalina ⁵³, R. Shaheen ¹⁴², J.D. Shahinian ¹²⁵, N.W. Shaikh ^{45a,45b}, D. Shaked Renous ¹⁶⁶, L.Y. Shan ^{13a}, M. Shapiro ^{16a}, A. Sharma ³⁴, A.S. Sharma ¹, S. Sharma ⁴⁶, P.B. Shatalov ³⁵, K. Shaw ¹⁴⁴, S.M. Shaw ⁹⁹, P. Sherwood ⁹³, L. Shi ⁹³, C.O. Shimmin ¹⁶⁹, Y. Shimogama ¹⁶⁵, J.D. Shinner ⁹², I.P.J. Shipsey ¹²³, S. Shirabe ⁵⁴, M. Shiyakova ³⁶, J. Shlomi ¹⁶⁶, M.J. Shochet ³⁷, J. Shojaii ¹⁰³, D.R. Shope ¹⁴², S. Shrestha ¹¹⁶, E.M. Shrif ^{31f}, M.J. Shroff ¹⁶², E. Shulga ¹⁶⁶, P. Sicho ¹²⁸, A.M. Sickles ¹⁵⁹, E. Sideras Haddad ^{31f}, O. Sidiropoulou ³⁴, A. Sidoti ^{21b}, F. Siegert ⁴⁸, Dj. Sijacki ¹⁴, J.M. Silva ¹⁹, M.V. Silva Oliveira ³⁴, S.B. Silverstein ^{45a}, S. Simion ⁶⁴, R. Simoniello ³⁴, S. Simsek ^{11b}, P. Sinervo ¹⁵³, V. Sinetckii ³⁵, S. Singh ¹⁴⁰, S. Singh ¹⁵³, S. Sinha ⁴⁶, S. Sinha ^{31f}, M. Sioli ^{21b,21a}, I. Siral ¹²⁰, S.Yu. Sivoklokov ^{35,*}, J. Sjölin ^{45a,45b}, A. Skaf ⁵³, E. Skorda ⁹⁵, P. Skubic ¹¹⁷, M. Slawinska ⁸³, K. Sliwa ¹⁵⁶, V. Smakhtin ¹⁶⁶, B.H. Smart ¹³¹, J. Smiesko ¹³⁰, S.Yu. Smirnov ³⁵, Y. Smirnov ³⁵, L.N. Smirnova ^{35,a}, O. Smirnova ⁹⁵, E.A. Smith ³⁷, H.A. Smith ¹²³, M. Smizanska ⁸⁸, K. Smolek ¹²⁹, A. Smykiewicz ⁸³, A.A. Snesarev ³⁵, H.L. Snoek ¹¹², S. Snyder ²⁷, R. Sobie ^{162,y}, A. Soffer ¹⁴⁹, F. Sohns ⁵³, C.A. Solans Sanchez ³⁴, E.Yu. Soldatov ³⁵, U. Soldevila ¹⁶⁰, A.A. Solodkov ³⁵, S. Solomon ⁵², A. Soloshenko ³⁶, O.V. Solovyanov ³⁵, V. Solovyev ³⁵, P. Sommer ¹³⁷, H. Son ¹⁵⁶, A. Sonay ¹², W.Y. Song ^{154b}, A. Sopczak ¹²⁹, A.L. Soppio ⁹³, F. Sopkova ^{26b}, S. Sottocornola ^{70a,70b}, R. Soualah ^{66a,66c}, Z. Soumami ^{33e}, D. South ⁴⁶, S. Spagnolo ^{67a,67b}, M. Spalla ¹⁰⁸, M. Spangenberg ¹⁶⁴, F. Spanò ⁹², D. Sperlich ⁵², T.M. Spieker ^{61a}, G. Spigo ³⁴, M. Spina ¹⁴⁴, D.P. Spiteri ⁵⁷, M. Spousta ¹³⁰, A. Stabile ^{68a,68b}, R. Stamen ^{61a}, M. Stamenkovic ¹¹², A. Stampekiš ¹⁹, M. Standke ²², E. Stanecka ⁸³, B. Stanislaus ³⁴, M.M. Stanitzki ⁴⁶, M. Stankaityte ¹²³, B. Stapf ⁴⁶, E.A. Starchenko ³⁵, G.H. Stark ¹³³, J. Stark ¹⁰⁰, D.M. Starko ^{154b}, P. Staroba ¹²⁸, P. Starovoitov ^{61a}, S. Stärz ¹⁰², R. Staszewski ⁸³, G. Stavropoulos ⁴⁴, P. Steinberg ²⁷, A.L. Steinhebel ¹²⁰, B. Stelzer ^{140,154a}, H.J. Stelzer ¹²⁶, O. Stelzer-Chilton ^{154a}, H. Stenzel ⁵⁶, T.J. Stevenson ¹⁴⁴, G.A. Stewart ³⁴, M.C. Stockton ³⁴, G. Stoicea ^{25b}, M. Stolarski ^{127a}, S. Stonjek ¹⁰⁸, A. Straessner ⁴⁸, J. Strandberg ¹⁴², S. Strandberg ^{45a,45b}, M. Strauss ¹¹⁷, T. Streblor ¹⁰⁰, P. Strizenec ^{26b}, R. Ströhmer ¹⁶³, D.M. Strom ¹²⁰, L.R. Strom ⁴⁶, R. Stroynowski ⁴², A. Strubig ^{45a,45b}, S.A. Stucci ²⁷, B. Stugu ¹⁵, J. Stupak ¹¹⁷, N.A. Styles ⁴⁶, D. Su ¹⁴¹, S. Su ^{60a}, W. Su ^{60d,136,60c}, X. Su ^{60a}, N.B. Suarez ¹²⁶, K. Sugizaki ¹⁵¹, V.V. Sulin ³⁵, M.J. Sullivan ⁸⁹, D.M.S. Sultan ⁵⁴, S. Sultansoy ^{3c}, T. Sumida ⁸⁴, S. Sun ¹⁰⁴, S. Sun ¹⁶⁷, X. Sun ⁹⁹, O. Sunneborn Gudnadottir ¹⁵⁸, C.J.E. Suster ¹⁴⁵, M.R. Sutton ¹⁴⁴, M. Svatos ¹²⁸, M. Swiatlowski ^{154a}, T. Swirski ¹⁶³, I. Sykora ^{26a}, M. Sykora ¹³⁰, T. Sykora ¹³⁰, D. Ta ⁹⁸, K. Tackmann ^{46,w}, A. Taffard ¹⁵⁷, R. Tafirout ^{154a}, E. Tagiev ³⁵, R.H.M. Taibah ¹²⁴, R. Takashima ⁸⁵, K. Takeda ⁸¹, T. Takeshita ¹³⁸, E.P. Takeva ⁵⁰, Y. Takubo ⁸⁰, M. Talby ¹⁰⁰, A.A. Talyshev ³⁵, K.C. Tam ^{62b}, N.M. Tamir ¹⁴⁹, A. Tanaka ¹⁵¹, J. Tanaka ¹⁵¹, R. Tanaka ⁶⁴, Z. Tao ¹⁶¹, S. Tapia Araya ⁷⁸, S. Tapprogge ⁹⁸, A. Tarek Abouelfadl Mohamed ¹⁰⁵, S. Tarem ¹⁴⁸, K. Tariq ^{60b}, G. Tarna ^{25b,g}, G.F. Tartarelli ^{68a}, P. Tas ¹³⁰, M. Tasevsky ¹²⁸, E. Tassi ^{41b,41a}, G. Tateno ¹⁵¹, Y. Tayalati ^{33e}, G.N. Taylor ¹⁰³, W. Taylor ^{154b}, H. Teagle ⁸⁹, A.S. Tee ¹⁶⁷, R. Teixeira De Lima ¹⁴¹, P. Teixeira-Dias ⁹², H. Ten Kate ³⁴, J.J. Teoh ¹¹², K. Terashi ¹⁵¹, J. Terron ⁹⁷, S. Terzo ¹², M. Testa ⁵¹, R.J. Teuscher ^{153,y}, N. Themistokleous ⁵⁰, T. Thevenaux-Pelzer ¹⁷, O. Thielmann ¹⁶⁸, D.W. Thomas ⁹², J.P. Thomas ¹⁹, E.A. Thompson ⁴⁶, P.D. Thompson ¹⁹, E. Thomson ¹²⁵, E.J. Thorpe ⁹¹, Y. Tian ⁵³, V. Tikhomirov ^{35,a}, Yu.A. Tikhonov ³⁵, S. Timoshenko ³⁵, P. Tipton ¹⁶⁹, S. Tisserant ¹⁰⁰, S.H. Tlou ^{31f}, A. Tmourji ³⁸, K. Todome ^{21b,21a}, S. Todorova-Nova ¹³⁰, S. Todt ⁴⁸, M. Togawa ⁸⁰, J. Tojo ⁸⁶, S. Tokár ^{26a}, K. Tokushuku ⁸⁰, E. Tolley ¹¹⁶, R. Tombs ³⁰, M. Tomoto ^{80,109}, L. Tompkins ¹⁴¹,

P. Tornambe ¹⁰¹, E. Torrence ¹²⁰, H. Torres ⁴⁸, E. Torró Pastor ¹⁶⁰, M. Toscani ²⁸, C. Toscirri ³⁷,
 J. Toth ^{100,x}, D.R. Tovey ¹³⁷, A. Traeet ¹⁵, C.J. Treado ¹¹⁴, T. Trefzger ¹⁶³, A. Tricoli ²⁷,
 I.M. Trigger ^{154a}, S. Trincaz-Duvoid ¹²⁴, D.A. Trischuk ¹⁶¹, B. Trocmé ⁵⁸, A. Trofymov ⁶⁴,
 C. Troncon ^{68a}, F. Trovato ¹⁴⁴, L. Truong ^{31c}, M. Trzebinski ⁸³, A. Trzupke ⁸³, F. Tsai ¹⁴³,
 A. Tsiamis ¹⁵⁰, P.V. Tsiareshka ^{35,a}, A. Tsirigotis ^{150,u}, V. Tsiskaridze ¹⁴³, E.G. Tskhadadze ^{147a},
 M. Tsopoulou ¹⁵⁰, I.I. Tsukerman ³⁵, V. Tsulaia ^{16a}, S. Tsuno ⁸⁰, O. Tsur ¹⁴⁸, D. Tsybychev ¹⁴³,
 Y. Tu ^{62b}, A. Tudorache ^{25b}, V. Tudorache ^{25b}, A.N. Tuna ³⁴, S. Turchikhin ³⁶, I. Turk Cakir ^{3b,t},
 R.J. Turner ¹⁹, R. Turra ^{68a}, P.M. Tuts ³⁹, S. Tzamarias ¹⁵⁰, P. Tzaniis ⁹, E. Tzovara ⁹⁸,
 K. Uchida ¹⁵¹, F. Ukegawa ¹⁵⁵, G. Unal ³⁴, M. Unal ¹⁰, A. Undrus ²⁷, G. Unel ¹⁵⁷,
 F.C. Ungaro ¹⁰³, K. Uno ¹⁵¹, J. Urban ^{26b}, P. Urquijo ¹⁰³, G. Usai ⁷, R. Ushioda ¹⁵²,
 M. Usman ¹⁰⁶, Z. Uysal ^{11d}, V. Vacek ¹²⁹, B. Vachon ¹⁰², K.O.H. Vadla ¹²², T. Vafeiadis ³⁴,
 C. Valderanis ¹⁰⁷, E. Valdes Santurio ^{45a,45b}, M. Valente ^{154a}, S. Valentinetti ^{21b,21a}, A. Valero ¹⁶⁰,
 L. Valéry ⁴⁶, R.A. Vallance ¹⁹, A. Vallier ¹⁰⁰, J.A. Valls Ferrer ¹⁶⁰, T.R. Van Daalen ¹³⁶,
 P. Van Gemmeren ⁵, S. Van Stroud ⁹³, I. Van Vulpen ¹¹², M. Vanadia ^{73a,73b}, W. Vandelli ³⁴,
 M. Vandenbroucke ¹³², E.R. Vandewall ¹¹⁸, D. Vannicola ¹⁴⁹, L. Vannoli ^{55b,55a}, R. Vari ^{72a},
 E.W. Varnes ⁶, C. Varni ^{16a}, T. Varol ¹⁴⁶, D. Varouchas ⁶⁴, K.E. Varvell ¹⁴⁵, M.E. Vasile ^{25b},
 L. Vaslin ³⁸, G.A. Vasquez ¹⁶², F. Vazeille ³⁸, D. Vazquez Furelos ¹², T. Vazquez Schroeder ³⁴,
 J. Veatch ⁵³, V. Vecchio ⁹⁹, M.J. Veen ¹¹², I. Velisek ¹²³, L.M. Veloce ¹⁵³, F. Veloso ^{127a,127c},
 S. Veneziano ^{72a}, A. Ventura ^{67a,67b}, A. Verbytskyi ¹⁰⁸, M. Verducci ^{71a,71b}, C. Vergis ²²,
 M. Verissimo De Araujo ^{79b}, W. Verkerke ¹¹², A.T. Vermeulen ¹¹², J.C. Vermeulen ¹¹²,
 C. Vernieri ¹⁴¹, P.J. Verschuuren ⁹², M.L. Vesterbacka ¹¹⁴, M.C. Vetterli ^{140,ah},
 A. Vgenopoulos ¹⁵⁰, N. Viaux Maira ^{134e}, T. Vickey ¹³⁷, O.E. Vickey Boeriu ¹³⁷,
 G.H.A. Viehhauser ¹²³, L. Vigani ^{61b}, M. Villa ^{21b,21a}, M. Villaplana Perez ¹⁶⁰, E.M. Villhauer ⁵⁰,
 E. Vilucchi ⁵¹, M.G. Vincter ³², G.S. Virdee ¹⁹, A. Vishwakarma ⁵⁰, C. Vittori ^{21b,21a},
 I. Vivarelli ¹⁴⁴, V. Vladimirov ¹⁶⁴, E. Voevodina ¹⁰⁸, M. Vogel ¹⁶⁸, P. Vokac ¹²⁹, J. Von Ahnen ⁴⁶,
 S.E. von Buddenbrock ^{31f}, E. Von Toerne ²², V. Vorobel ¹³⁰, K. Vorobev ³⁵, M. Vos ¹⁶⁰,
 J.H. Vosseveld ⁸⁹, M. Vozak ⁹⁹, L. Vozdecky ⁹¹, N. Vranjes ¹⁴, M. Vranjes Milosavljevic ¹⁴,
 V. Vrba ^{129,*}, M. Vreeswijk ¹¹², R. Vuillermet ³⁴, O. Vujanovic ⁹⁸, I. Vukotic ³⁷, S. Wada ¹⁵⁵,
 C. Wagner ¹⁰¹, W. Wagner ¹⁶⁸, S. Wahdan ¹⁶⁸, H. Wahlberg ⁸⁷, R. Wakasa ¹⁵⁵, M. Wakida ¹⁰⁹,
 V.M. Walbrecht ¹⁰⁸, J. Walder ¹³¹, R. Walker ¹⁰⁷, S.D. Walker ⁹², W. Walkowiak ¹³⁹,
 A.M. Wang ⁵⁹, A.Z. Wang ¹⁶⁷, C. Wang ^{60a}, C. Wang ^{60c}, H. Wang ^{16a}, J. Wang ^{62a},
 P. Wang ⁴², R.-J. Wang ⁹⁸, R. Wang ⁵⁹, R. Wang ¹¹³, S.M. Wang ¹⁴⁶, S. Wang ^{60b},
 T. Wang ^{60a}, W.T. Wang ^{60a}, W.X. Wang ^{60a}, X. Wang ^{13c}, X. Wang ¹⁵⁹, Y. Wang ^{60a},
 Z. Wang ¹⁰⁴, C. Wanotayaroj ³⁴, A. Warburton ¹⁰², C.P. Ward ³⁰, R.J. Ward ¹⁹, N. Warrack ⁵⁷,
 A.T. Watson ¹⁹, M.F. Watson ¹⁹, G. Watts ¹³⁶, B.M. Waugh ⁹³, A.F. Webb ¹⁰, C. Weber ²⁷,
 M.S. Weber ¹⁸, S.A. Weber ³², S.M. Weber ^{61a}, C. Wei ^{60a}, Y. Wei ¹²³, A.R. Weidberg ¹²³,
 J. Weingarten ⁴⁷, M. Weirich ⁹⁸, C. Weiser ⁵², T. Wenaus ²⁷, B. Wendland ⁴⁷, T. Wengler ³⁴,
 S. Wenig ³⁴, N. Wermes ²², M. Wessels ^{61a}, K. Whalen ¹²⁰, A.M. Wharton ⁸⁸, A.S. White ⁵⁹,
 A. White ⁷, M.J. White ¹, D. Whiteson ¹⁵⁷, L. Wickremasinghe ¹²¹, W. Wiedenmann ¹⁶⁷,
 C. Wiel ⁴⁸, M. Wielers ¹³¹, N. Wieseotte ⁹⁸, C. Wiglesworth ⁴⁰, L.A.M. Wiik-Fuchs ⁵²,
 D.J. Wilbern ¹¹⁷, H.G. Wilkens ³⁴, L.J. Wilkins ⁹², D.M. Williams ³⁹, H.H. Williams ¹²⁵,
 S. Williams ³⁰, S. Willocq ¹⁰¹, P.J. Windischhofer ¹²³, I. Wingerter-Seez ⁴, F. Winklmeier ¹²⁰,
 B.T. Winter ⁵², M. Wittgen ¹⁴¹, M. Wobisch ⁹⁴, A. Wolf ⁹⁸, R. Wölker ¹²³, J. Wollrath ¹⁵⁷,
 M.W. Wolter ⁸³, H. Wolters ^{127a,127c}, V.W.S. Wong ¹⁶¹, A.F. Wongel ⁴⁶, S.D. Worm ⁴⁶,
 B.K. Wosiek ⁸³, K.W. Woźniak ⁸³, K. Wraight ⁵⁷, J. Wu ^{13a,13d}, S.L. Wu ¹⁶⁷, X. Wu ⁵⁴,
 Y. Wu ^{60a}, Z. Wu ^{132,60a}, J. Wuerzinger ¹²³, T.R. Wyatt ⁹⁹, B.M. Wynne ⁵⁰, S. Xella ⁴⁰,
 M. Xia ^{13b}, J. Xiang ^{62c}, X. Xiao ¹⁰⁴, M. Xie ^{60a}, X. Xie ^{60a}, I. Xiotidis ¹⁴⁴, D. Xu ^{13a}, H. Xu ^{60a},

H. Xu , L. Xu , R. Xu , T. Xu , W. Xu , Y. Xu , Z. Xu , Z. Xu , B. Yabsley , S. Yacoob , N. Yamaguchi , Y. Yamaguchi , M. Yamatani , H. Yamauchi , T. Yamazaki , Y. Yamazaki , J. Yan , S. Yan , Z. Yan , H.J. Yang , H.T. Yang , S. Yang , T. Yang , X. Yang , X. Yang , Y. Yang , Z. Yang , W-M. Yao , Y.C. Yap , H. Ye , J. Ye , S. Ye , I. Yeletsikh , M.R. Yexley , P. Yin , K. Yorita , K. Yoshihara , C.J.S. Young , C. Young , R. Yuan , X. Yue , M. Zaazoua , B. Zabinski , G. Zacharis , E. Zaid , T. Zakareishvili , N. Zakharchuk , S. Zambito , D. Zanzi , S.V. Zeibner , C. Zeitnitz , J.C. Zeng , O. Zenin , T. Ženiš , S. Zenz , S. Zerradi , D. Zerwas , M. Zgubič , B. Zhang , D.F. Zhang , G. Zhang , J. Zhang , K. Zhang , L. Zhang , M. Zhang , R. Zhang , S. Zhang , X. Zhang , X. Zhang , Z. Zhang , P. Zhao , Y. Zhao , Z. Zhao , A. Zhemchugov , Z. Zheng , D. Zhong , B. Zhou , C. Zhou , H. Zhou , N. Zhou , Y. Zhou , C.G. Zhu , C. Zhu , H.L. Zhu , H. Zhu , J. Zhu , Y. Zhu , X. Zhuang , K. Zhukov , V. Zhulanov , D. Zieminska , N.I. Zimine , S. Zimmermann , J. Zinsser , M. Ziolkowski , L. Živković , A. Zoccoli , K. Zoch , T.G. Zorbas , O. Zormpa , W. Zou , L. Zwalinski .

¹Department of Physics, University of Adelaide, Adelaide; Australia.

²Department of Physics, University of Alberta, Edmonton AB; Canada.

³(^a)Department of Physics, Ankara University, Ankara; (^b)Istanbul Aydin University, Application and Research Center for Advanced Studies, Istanbul; (^c)Division of Physics, TOBB University of Economics and Technology, Ankara; Türkiye.

⁴LAPP, Univ. Savoie Mont Blanc, CNRS/IN2P3, Annecy; France.

⁵High Energy Physics Division, Argonne National Laboratory, Argonne IL; United States of America.

⁶Department of Physics, University of Arizona, Tucson AZ; United States of America.

⁷Department of Physics, University of Texas at Arlington, Arlington TX; United States of America.

⁸Physics Department, National and Kapodistrian University of Athens, Athens; Greece.

⁹Physics Department, National Technical University of Athens, Zografou; Greece.

¹⁰Department of Physics, University of Texas at Austin, Austin TX; United States of America.

¹¹(^a)Bahcesehir University, Faculty of Engineering and Natural Sciences, Istanbul; (^b)Istanbul Bilgi University, Faculty of Engineering and Natural Sciences, Istanbul; (^c)Department of Physics, Bogazici University, Istanbul; (^d)Department of Physics Engineering, Gaziantep University, Gaziantep; Türkiye.

¹²Institut de Física d'Altes Energies (IFAE), Barcelona Institute of Science and Technology, Barcelona; Spain.

¹³(^a)Institute of High Energy Physics, Chinese Academy of Sciences, Beijing; (^b)Physics Department, Tsinghua University, Beijing; (^c)Department of Physics, Nanjing University, Nanjing; (^d)University of Chinese Academy of Science (UCAS), Beijing; China.

¹⁴Institute of Physics, University of Belgrade, Belgrade; Serbia.

¹⁵Department for Physics and Technology, University of Bergen, Bergen; Norway.

¹⁶(^a)Physics Division, Lawrence Berkeley National Laboratory, Berkeley CA; (^b)University of California, Berkeley CA; United States of America.

¹⁷Institut für Physik, Humboldt Universität zu Berlin, Berlin; Germany.

¹⁸Albert Einstein Center for Fundamental Physics and Laboratory for High Energy Physics, University of Bern, Bern; Switzerland.

¹⁹School of Physics and Astronomy, University of Birmingham, Birmingham; United Kingdom.

²⁰(^a)Facultad de Ciencias y Centro de Investigaciones, Universidad Antonio Nariño,

- Bogotá;^(b)Departamento de Física, Universidad Nacional de Colombia, Bogotá; Colombia.
- ²¹(a)Dipartimento di Fisica e Astronomia A. Righi, Università di Bologna, Bologna;^(b)INFN Sezione di Bologna; Italy.
- ²²Physikalisches Institut, Universität Bonn, Bonn; Germany.
- ²³Department of Physics, Boston University, Boston MA; United States of America.
- ²⁴Department of Physics, Brandeis University, Waltham MA; United States of America.
- ²⁵(a)Transilvania University of Brasov, Brasov;^(b)Horia Hulubei National Institute of Physics and Nuclear Engineering, Bucharest;^(c)Department of Physics, Alexandru Ioan Cuza University of Iasi, Iasi;^(d)National Institute for Research and Development of Isotopic and Molecular Technologies, Physics Department, Cluj-Napoca;^(e)University Politehnica Bucharest, Bucharest;^(f)West University in Timisoara, Timisoara; Romania.
- ²⁶(a)Faculty of Mathematics, Physics and Informatics, Comenius University, Bratislava;^(b)Department of Subnuclear Physics, Institute of Experimental Physics of the Slovak Academy of Sciences, Kosice; Slovak Republic.
- ²⁷Physics Department, Brookhaven National Laboratory, Upton NY; United States of America.
- ²⁸Universidad de Buenos Aires, Facultad de Ciencias Exactas y Naturales, Departamento de Física, y CONICET, Instituto de Física de Buenos Aires (IFIBA), Buenos Aires; Argentina.
- ²⁹California State University, CA; United States of America.
- ³⁰Cavendish Laboratory, University of Cambridge, Cambridge; United Kingdom.
- ³¹(a)Department of Physics, University of Cape Town, Cape Town;^(b)iThemba Labs, Western Cape;^(c)Department of Mechanical Engineering Science, University of Johannesburg, Johannesburg;^(d)National Institute of Physics, University of the Philippines Diliman (Philippines);^(e)University of South Africa, Department of Physics, Pretoria;^(f)School of Physics, University of the Witwatersrand, Johannesburg; South Africa.
- ³²Department of Physics, Carleton University, Ottawa ON; Canada.
- ³³(a)Faculté des Sciences Ain Chock, Réseau Universitaire de Physique des Hautes Energies - Université Hassan II, Casablanca;^(b)Faculté des Sciences, Université Ibn-Tofail, Kénitra;^(c)Faculté des Sciences Semlalia, Université Cadi Ayyad, LPHEA-Marrakech;^(d)LPMR, Faculté des Sciences, Université Mohamed Premier, Oujda;^(e)Faculté des sciences, Université Mohammed V, Rabat; Morocco.
- ³⁴CERN, Geneva; Switzerland.
- ³⁵Affiliated with an institute covered by a cooperation agreement with CERN.
- ³⁶Affiliated with an international laboratory covered by a cooperation agreement with CERN.
- ³⁷Enrico Fermi Institute, University of Chicago, Chicago IL; United States of America.
- ³⁸LPC, Université Clermont Auvergne, CNRS/IN2P3, Clermont-Ferrand; France.
- ³⁹Nevis Laboratory, Columbia University, Irvington NY; United States of America.
- ⁴⁰Niels Bohr Institute, University of Copenhagen, Copenhagen; Denmark.
- ⁴¹(a)Dipartimento di Fisica, Università della Calabria, Rende;^(b)INFN Gruppo Collegato di Cosenza, Laboratori Nazionali di Frascati; Italy.
- ⁴²Physics Department, Southern Methodist University, Dallas TX; United States of America.
- ⁴³Physics Department, University of Texas at Dallas, Richardson TX; United States of America.
- ⁴⁴National Centre for Scientific Research "Demokritos", Agia Paraskevi; Greece.
- ⁴⁵(a)Department of Physics, Stockholm University;^(b)Oskar Klein Centre, Stockholm; Sweden.
- ⁴⁶Deutsches Elektronen-Synchrotron DESY, Hamburg and Zeuthen; Germany.
- ⁴⁷Fakultät Physik , Technische Universität Dortmund, Dortmund; Germany.
- ⁴⁸Institut für Kern- und Teilchenphysik, Technische Universität Dresden, Dresden; Germany.
- ⁴⁹Department of Physics, Duke University, Durham NC; United States of America.
- ⁵⁰SUPA - School of Physics and Astronomy, University of Edinburgh, Edinburgh; United Kingdom.

- ⁵¹INFN e Laboratori Nazionali di Frascati, Frascati; Italy.
- ⁵²Physikalisches Institut, Albert-Ludwigs-Universität Freiburg, Freiburg; Germany.
- ⁵³II. Physikalisches Institut, Georg-August-Universität Göttingen, Göttingen; Germany.
- ⁵⁴Département de Physique Nucléaire et Corpusculaire, Université de Genève, Genève; Switzerland.
- ⁵⁵(^a) Dipartimento di Fisica, Università di Genova, Genova; (^b) INFN Sezione di Genova; Italy.
- ⁵⁶II. Physikalisches Institut, Justus-Liebig-Universität Giessen, Giessen; Germany.
- ⁵⁷SUPA - School of Physics and Astronomy, University of Glasgow, Glasgow; United Kingdom.
- ⁵⁸LPSC, Université Grenoble Alpes, CNRS/IN2P3, Grenoble INP, Grenoble; France.
- ⁵⁹Laboratory for Particle Physics and Cosmology, Harvard University, Cambridge MA; United States of America.
- ⁶⁰(^a) Department of Modern Physics and State Key Laboratory of Particle Detection and Electronics, University of Science and Technology of China, Hefei; (^b) Institute of Frontier and Interdisciplinary Science and Key Laboratory of Particle Physics and Particle Irradiation (MOE), Shandong University, Qingdao; (^c) School of Physics and Astronomy, Shanghai Jiao Tong University, Key Laboratory for Particle Astrophysics and Cosmology (MOE), SKLPPC, Shanghai; (^d) Tsung-Dao Lee Institute, Shanghai; China.
- ⁶¹(^a) Kirchhoff-Institut für Physik, Ruprecht-Karls-Universität Heidelberg, Heidelberg; (^b) Physikalisches Institut, Ruprecht-Karls-Universität Heidelberg, Heidelberg; Germany.
- ⁶²(^a) Department of Physics, Chinese University of Hong Kong, Shatin, N.T., Hong Kong; (^b) Department of Physics, University of Hong Kong, Hong Kong; (^c) Department of Physics and Institute for Advanced Study, Hong Kong University of Science and Technology, Clear Water Bay, Kowloon, Hong Kong; China.
- ⁶³Department of Physics, National Tsing Hua University, Hsinchu; Taiwan.
- ⁶⁴IJCLab, Université Paris-Saclay, CNRS/IN2P3, 91405, Orsay; France.
- ⁶⁵Department of Physics, Indiana University, Bloomington IN; United States of America.
- ⁶⁶(^a) INFN Gruppo Collegato di Udine, Sezione di Trieste, Udine; (^b) ICTP, Trieste; (^c) Dipartimento Politecnico di Ingegneria e Architettura, Università di Udine, Udine; Italy.
- ⁶⁷(^a) INFN Sezione di Lecce; (^b) Dipartimento di Matematica e Fisica, Università del Salento, Lecce; Italy.
- ⁶⁸(^a) INFN Sezione di Milano; (^b) Dipartimento di Fisica, Università di Milano, Milano; Italy.
- ⁶⁹(^a) INFN Sezione di Napoli; (^b) Dipartimento di Fisica, Università di Napoli, Napoli; Italy.
- ⁷⁰(^a) INFN Sezione di Pavia; (^b) Dipartimento di Fisica, Università di Pavia, Pavia; Italy.
- ⁷¹(^a) INFN Sezione di Pisa; (^b) Dipartimento di Fisica E. Fermi, Università di Pisa, Pisa; Italy.
- ⁷²(^a) INFN Sezione di Roma; (^b) Dipartimento di Fisica, Sapienza Università di Roma, Roma; Italy.
- ⁷³(^a) INFN Sezione di Roma Tor Vergata; (^b) Dipartimento di Fisica, Università di Roma Tor Vergata, Roma; Italy.
- ⁷⁴(^a) INFN Sezione di Roma Tre; (^b) Dipartimento di Matematica e Fisica, Università Roma Tre, Roma; Italy.
- ⁷⁵(^a) INFN-TIFPA; (^b) Università degli Studi di Trento, Trento; Italy.
- ⁷⁶Universität Innsbruck, Department of Astro and Particle Physics, Innsbruck; Austria.
- ⁷⁷University of Iowa, Iowa City IA; United States of America.
- ⁷⁸Department of Physics and Astronomy, Iowa State University, Ames IA; United States of America.
- ⁷⁹(^a) Departamento de Engenharia Elétrica, Universidade Federal de Juiz de Fora (UFJF), Juiz de Fora; (^b) Universidade Federal do Rio De Janeiro COPPE/EE/IF, Rio de Janeiro; (^c) Instituto de Física, Universidade de São Paulo, São Paulo; Brazil.
- ⁸⁰KEK, High Energy Accelerator Research Organization, Tsukuba; Japan.
- ⁸¹Graduate School of Science, Kobe University, Kobe; Japan.
- ⁸²(^a) AGH University of Science and Technology, Faculty of Physics and Applied Computer Science, Krakow; (^b) Marian Smoluchowski Institute of Physics, Jagiellonian University, Krakow; Poland.
- ⁸³Institute of Nuclear Physics Polish Academy of Sciences, Krakow; Poland.

- ⁸⁴Faculty of Science, Kyoto University, Kyoto; Japan.
- ⁸⁵Kyoto University of Education, Kyoto; Japan.
- ⁸⁶Research Center for Advanced Particle Physics and Department of Physics, Kyushu University, Fukuoka ; Japan.
- ⁸⁷Instituto de Física La Plata, Universidad Nacional de La Plata and CONICET, La Plata; Argentina.
- ⁸⁸Physics Department, Lancaster University, Lancaster; United Kingdom.
- ⁸⁹Oliver Lodge Laboratory, University of Liverpool, Liverpool; United Kingdom.
- ⁹⁰Department of Experimental Particle Physics, Jožef Stefan Institute and Department of Physics, University of Ljubljana, Ljubljana; Slovenia.
- ⁹¹School of Physics and Astronomy, Queen Mary University of London, London; United Kingdom.
- ⁹²Department of Physics, Royal Holloway University of London, Egham; United Kingdom.
- ⁹³Department of Physics and Astronomy, University College London, London; United Kingdom.
- ⁹⁴Louisiana Tech University, Ruston LA; United States of America.
- ⁹⁵Fysiska institutionen, Lunds universitet, Lund; Sweden.
- ⁹⁶Centre de Calcul de l'Institut National de Physique Nucléaire et de Physique des Particules (IN2P3), Villeurbanne; France.
- ⁹⁷Departamento de Física Teórica C-15 and CIAFF, Universidad Autónoma de Madrid, Madrid; Spain.
- ⁹⁸Institut für Physik, Universität Mainz, Mainz; Germany.
- ⁹⁹School of Physics and Astronomy, University of Manchester, Manchester; United Kingdom.
- ¹⁰⁰CPPM, Aix-Marseille Université, CNRS/IN2P3, Marseille; France.
- ¹⁰¹Department of Physics, University of Massachusetts, Amherst MA; United States of America.
- ¹⁰²Department of Physics, McGill University, Montreal QC; Canada.
- ¹⁰³School of Physics, University of Melbourne, Victoria; Australia.
- ¹⁰⁴Department of Physics, University of Michigan, Ann Arbor MI; United States of America.
- ¹⁰⁵Department of Physics and Astronomy, Michigan State University, East Lansing MI; United States of America.
- ¹⁰⁶Group of Particle Physics, University of Montreal, Montreal QC; Canada.
- ¹⁰⁷Fakultät für Physik, Ludwig-Maximilians-Universität München, München; Germany.
- ¹⁰⁸Max-Planck-Institut für Physik (Werner-Heisenberg-Institut), München; Germany.
- ¹⁰⁹Graduate School of Science and Kobayashi-Maskawa Institute, Nagoya University, Nagoya; Japan.
- ¹¹⁰Department of Physics and Astronomy, University of New Mexico, Albuquerque NM; United States of America.
- ¹¹¹Institute for Mathematics, Astrophysics and Particle Physics, Radboud University/Nikhef, Nijmegen; Netherlands.
- ¹¹²Nikhef National Institute for Subatomic Physics and University of Amsterdam, Amsterdam; Netherlands.
- ¹¹³Department of Physics, Northern Illinois University, DeKalb IL; United States of America.
- ¹¹⁴Department of Physics, New York University, New York NY; United States of America.
- ¹¹⁵Ochanomizu University, Otsuka, Bunkyo-ku, Tokyo; Japan.
- ¹¹⁶Ohio State University, Columbus OH; United States of America.
- ¹¹⁷Homer L. Dodge Department of Physics and Astronomy, University of Oklahoma, Norman OK; United States of America.
- ¹¹⁸Department of Physics, Oklahoma State University, Stillwater OK; United States of America.
- ¹¹⁹Palacký University, Joint Laboratory of Optics, Olomouc; Czech Republic.
- ¹²⁰Institute for Fundamental Science, University of Oregon, Eugene, OR; United States of America.
- ¹²¹Graduate School of Science, Osaka University, Osaka; Japan.
- ¹²²Department of Physics, University of Oslo, Oslo; Norway.

- ¹²³Department of Physics, Oxford University, Oxford; United Kingdom.
- ¹²⁴LPNHE, Sorbonne Université, Université Paris Cité, CNRS/IN2P3, Paris; France.
- ¹²⁵Department of Physics, University of Pennsylvania, Philadelphia PA; United States of America.
- ¹²⁶Department of Physics and Astronomy, University of Pittsburgh, Pittsburgh PA; United States of America.
- ¹²⁷(^a)Laboratório de Instrumentação e Física Experimental de Partículas - LIP, Lisboa; (^b)Departamento de Física, Faculdade de Ciências, Universidade de Lisboa, Lisboa; (^c)Departamento de Física, Universidade de Coimbra, Coimbra; (^d)Centro de Física Nuclear da Universidade de Lisboa, Lisboa; (^e)Departamento de Física, Universidade do Minho, Braga; (^f)Departamento de Física Teórica y del Cosmos, Universidad de Granada, Granada (Spain); (^g)Dep Física and CEFITEC of Faculdade de Ciências e Tecnologia, Universidade Nova de Lisboa, Caparica; (^h)Instituto Superior Técnico, Universidade de Lisboa, Lisboa; Portugal.
- ¹²⁸Institute of Physics of the Czech Academy of Sciences, Prague; Czech Republic.
- ¹²⁹Czech Technical University in Prague, Prague; Czech Republic.
- ¹³⁰Charles University, Faculty of Mathematics and Physics, Prague; Czech Republic.
- ¹³¹Particle Physics Department, Rutherford Appleton Laboratory, Didcot; United Kingdom.
- ¹³²IRFU, CEA, Université Paris-Saclay, Gif-sur-Yvette; France.
- ¹³³Santa Cruz Institute for Particle Physics, University of California Santa Cruz, Santa Cruz CA; United States of America.
- ¹³⁴(^a)Departamento de Física, Pontificia Universidad Católica de Chile, Santiago; (^b)Millennium Institute for Subatomic physics at high energy frontier (SAPHIR), Santiago; (^c)Universidad Andres Bello, Department of Physics, Santiago; (^d)Instituto de Alta Investigación, Universidad de Tarapacá, Arica; (^e)Departamento de Física, Universidad Técnica Federico Santa María, Valparaíso; Chile.
- ¹³⁵Universidade Federal de São João del Rei (UFSJ), São João del Rei; Brazil.
- ¹³⁶Department of Physics, University of Washington, Seattle WA; United States of America.
- ¹³⁷Department of Physics and Astronomy, University of Sheffield, Sheffield; United Kingdom.
- ¹³⁸Department of Physics, Shinshu University, Nagano; Japan.
- ¹³⁹Department Physik, Universität Siegen, Siegen; Germany.
- ¹⁴⁰Department of Physics, Simon Fraser University, Burnaby BC; Canada.
- ¹⁴¹SLAC National Accelerator Laboratory, Stanford CA; United States of America.
- ¹⁴²Department of Physics, Royal Institute of Technology, Stockholm; Sweden.
- ¹⁴³Departments of Physics and Astronomy, Stony Brook University, Stony Brook NY; United States of America.
- ¹⁴⁴Department of Physics and Astronomy, University of Sussex, Brighton; United Kingdom.
- ¹⁴⁵School of Physics, University of Sydney, Sydney; Australia.
- ¹⁴⁶Institute of Physics, Academia Sinica, Taipei; Taiwan.
- ¹⁴⁷(^a)E. Andronikashvili Institute of Physics, Iv. Javakhishvili Tbilisi State University, Tbilisi; (^b)High Energy Physics Institute, Tbilisi State University, Tbilisi; Georgia.
- ¹⁴⁸Department of Physics, Technion, Israel Institute of Technology, Haifa; Israel.
- ¹⁴⁹Raymond and Beverly Sackler School of Physics and Astronomy, Tel Aviv University, Tel Aviv; Israel.
- ¹⁵⁰Department of Physics, Aristotle University of Thessaloniki, Thessaloniki; Greece.
- ¹⁵¹International Center for Elementary Particle Physics and Department of Physics, University of Tokyo, Tokyo; Japan.
- ¹⁵²Department of Physics, Tokyo Institute of Technology, Tokyo; Japan.
- ¹⁵³Department of Physics, University of Toronto, Toronto ON; Canada.
- ¹⁵⁴(^a)TRIUMF, Vancouver BC; (^b)Department of Physics and Astronomy, York University, Toronto ON; Canada.

- ¹⁵⁵Division of Physics and Tomonaga Center for the History of the Universe, Faculty of Pure and Applied Sciences, University of Tsukuba, Tsukuba; Japan.
- ¹⁵⁶Department of Physics and Astronomy, Tufts University, Medford MA; United States of America.
- ¹⁵⁷Department of Physics and Astronomy, University of California Irvine, Irvine CA; United States of America.
- ¹⁵⁸Department of Physics and Astronomy, University of Uppsala, Uppsala; Sweden.
- ¹⁵⁹Department of Physics, University of Illinois, Urbana IL; United States of America.
- ¹⁶⁰Instituto de Física Corpuscular (IFIC), Centro Mixto Universidad de Valencia - CSIC, Valencia; Spain.
- ¹⁶¹Department of Physics, University of British Columbia, Vancouver BC; Canada.
- ¹⁶²Department of Physics and Astronomy, University of Victoria, Victoria BC; Canada.
- ¹⁶³Fakultät für Physik und Astronomie, Julius-Maximilians-Universität Würzburg, Würzburg; Germany.
- ¹⁶⁴Department of Physics, University of Warwick, Coventry; United Kingdom.
- ¹⁶⁵Waseda University, Tokyo; Japan.
- ¹⁶⁶Department of Particle Physics and Astrophysics, Weizmann Institute of Science, Rehovot; Israel.
- ¹⁶⁷Department of Physics, University of Wisconsin, Madison WI; United States of America.
- ¹⁶⁸Fakultät für Mathematik und Naturwissenschaften, Fachgruppe Physik, Bergische Universität Wuppertal, Wuppertal; Germany.
- ¹⁶⁹Department of Physics, Yale University, New Haven CT; United States of America.
- ^a Also Affiliated with an institute covered by a cooperation agreement with CERN.
- ^b Also at Borough of Manhattan Community College, City University of New York, New York NY; United States of America.
- ^c Also at Bruno Kessler Foundation, Trento; Italy.
- ^d Also at Center for High Energy Physics, Peking University; China.
- ^e Also at Centro Studi e Ricerche Enrico Fermi; Italy.
- ^f Also at CERN, Geneva; Switzerland.
- ^g Also at CPPM, Aix-Marseille Université, CNRS/IN2P3, Marseille; France.
- ^h Also at Département de Physique Nucléaire et Corpusculaire, Université de Genève, Genève; Switzerland.
- ⁱ Also at Departament de Física de la Universitat Autònoma de Barcelona, Barcelona; Spain.
- ^j Also at Department of Financial and Management Engineering, University of the Aegean, Chios; Greece.
- ^k Also at Department of Physics and Astronomy, Michigan State University, East Lansing MI; United States of America.
- ^l Also at Department of Physics and Astronomy, University of Louisville, Louisville, KY; United States of America.
- ^m Also at Department of Physics, Ben Gurion University of the Negev, Beer Sheva; Israel.
- ⁿ Also at Department of Physics, California State University, East Bay; United States of America.
- ^o Also at Department of Physics, California State University, Fresno; United States of America.
- ^p Also at Department of Physics, California State University, Sacramento; United States of America.
- ^q Also at Department of Physics, King's College London, London; United Kingdom.
- ^r Also at Department of Physics, University of Fribourg, Fribourg; Switzerland.
- ^s Also at Faculty of Physics, Sofia University, 'St. Kliment Ohridski', Sofia; Bulgaria.
- ^t Also at Giresun University, Faculty of Engineering, Giresun; Türkiye.
- ^u Also at Hellenic Open University, Patras; Greece.
- ^v Also at Institutio Catalana de Recerca i Estudis Avancats, ICREA, Barcelona; Spain.
- ^w Also at Institut für Experimentalphysik, Universität Hamburg, Hamburg; Germany.
- ^x Also at Institute for Particle and Nuclear Physics, Wigner Research Centre for Physics, Budapest; Hungary.

- y* Also at Institute of Particle Physics (IPP); Canada.
- z* Also at Institute of Physics, Azerbaijan Academy of Sciences, Baku; Azerbaijan.
- aa* Also at Institute of Theoretical Physics, Ilia State University, Tbilisi; Georgia.
- ab* Also at Instituto de Fisica Teorica, IFT-UAM/CSIC, Madrid; Spain.
- ac* Also at Istanbul University, Dept. of Physics, Istanbul; Türkiye.
- ad* Also at Physics Department, An-Najah National University, Nablus; Palestine.
- ae* Also at Physikalisches Institut, Albert-Ludwigs-Universität Freiburg, Freiburg; Germany.
- af* Also at The City College of New York, New York NY; United States of America.
- ag* Also at The Collaborative Innovation Center of Quantum Matter (CICQM), Beijing; China.
- ah* Also at TRIUMF, Vancouver BC; Canada.
- ai* Also at Università di Napoli Parthenope, Napoli; Italy.
- aj* Also at University of Chinese Academy of Sciences (UCAS), Beijing; China.
- ak* Also at Yeditepe University, Physics Department, Istanbul; Türkiye.
- al* Also at RWTH Aachen University, III. Physikalisches Institut A, Aachen; Germany.
- * Deceased