

DÉFAUTS

TEMP. E.D. TROP HAUTE	NIVEAU ED TROP BAS	MANQUE DÉBIT ED	CONDUCT. E.D. TROP HAUTE	ENLECH. AUTO.
DISJONCT. HORS	REMP LIS. TROP LONG			

AIMANT PS

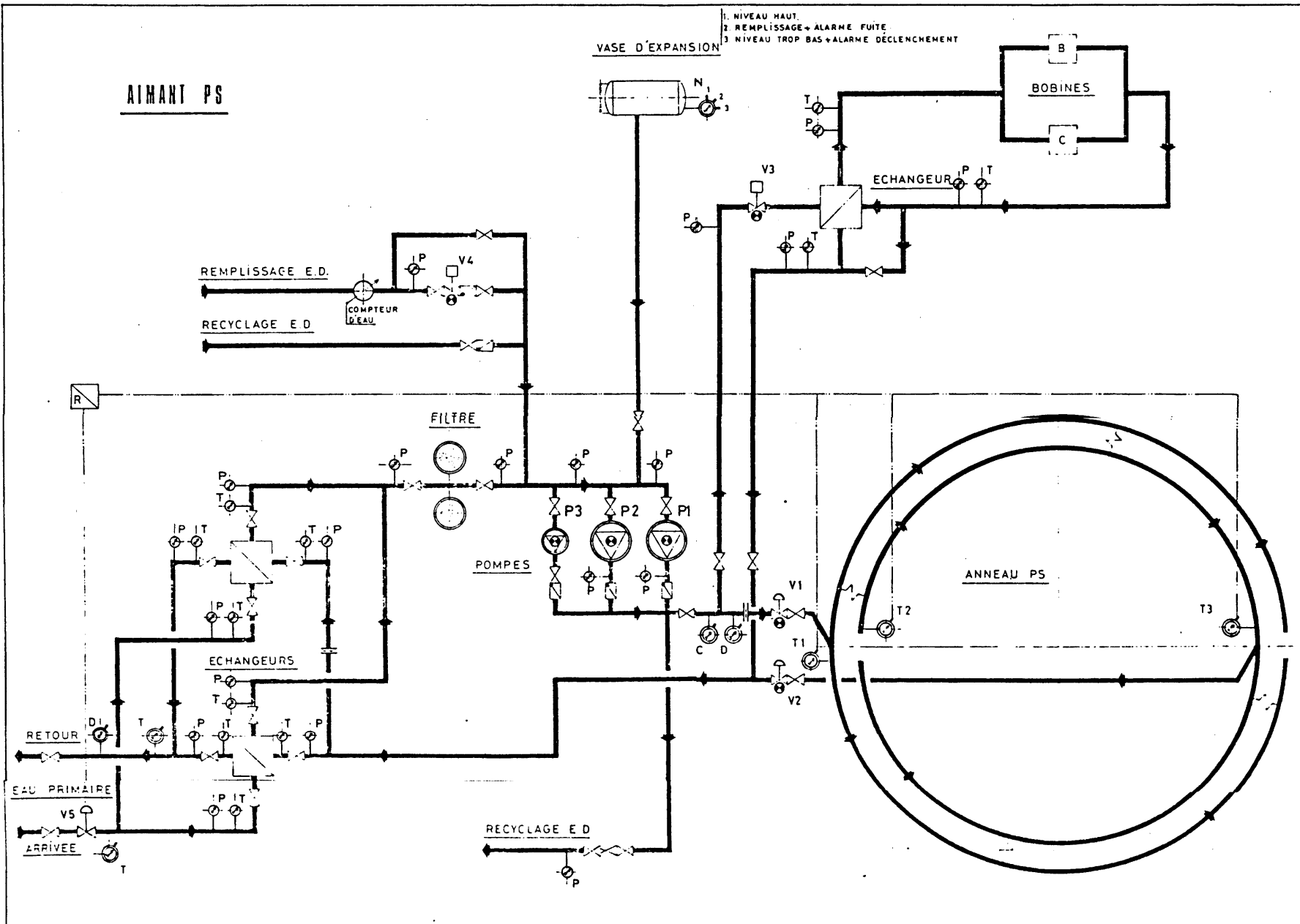

COMMANDES

POMPES

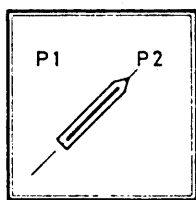

REMPLISSAGE (V4)

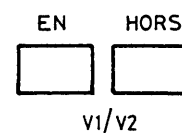
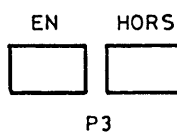
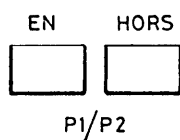
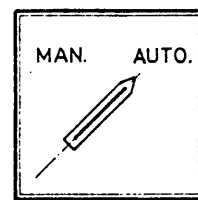
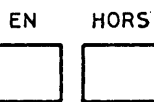

H1

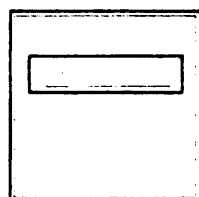

H2

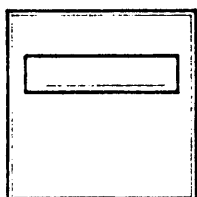

H3

