

DD

E13-94-351

sw 0503

V.N.Bychkov, G.D.Kekelidze, E.A.Novikov,
V.D.Peshekhonov, M.D.Shafranov, V.E.Zhiltsov

CATHODE READOUT WITH STRIPPED
RESISTIVE DRIFT TUBES

SCAN-9501079



CERN LIBRARIES, GENEVA

Submitted to «Vienna Wire Chamber Conference», Austria, February,
1995.

1994

I. INTRODUCTION

Being used in large detecting systems, thin film drift tubes have some advantages to compare with traditional gaseous position detectors. They are more reliable: a break down of one anode wire causes a break down of only one readout channel. Simple fuses can be used to automatically switch unoperational channels off [1], which is important in large systems. Also, such tubes can be filled with gas at excessive pressure from a few Torr up to 2—3 atm [2].

Readout of the position information along the wire is especially interesting, for in this case the spatial accuracy (for the tracks close to perpendicular to the wire) does not depend on the tube dimension, i.e. the granularity of the detecting system. In [3] we showed the possibility of strip readout for aluminized mylar drift tubes with longitudinal window by means of outer strips. To compare with honeycomb chambers, this detector is more reliable, but its signal-to-noise ratio, which defines the spatial accuracy in large detectors, is lower [4].

Basing on the transparency of resistive cathodes for strip readout [5], the authors of [6] realized position information readout from outer strips of 4 mm diameter straw tubes made from 100 Ohm/sq capton film. The spatial resolution (r.m.s.) was 85 mkm for 7.4 keV X-rays.

In this paper we present the results of the study of stripped thin film tubes with carbon resistive coating. We investigated several prototypes using films of resistivity from 0.5 up to 70 kOhm/sq.

II. PROTOTYPES

Amplitude characteristics of several prototype tubes made from different types of resistive films have been studied. Figure 1 shows the layout of the prototypes. The 16 cm length straw tubes are mounted on 2 mm thick G10 plate with St pitch. Each straw has «ring strips» on its outer surface of Ac width and Sc pitch. Each ring strip has galvanic contact with strip bus. The 3 mm wide strip buses are located on the back side of the plate with the pitch 7 mm. The signals from anode and from the central strip bus were registered. The rest of the buses are connected to the common ground with 62 Ohm resistors (this is the input

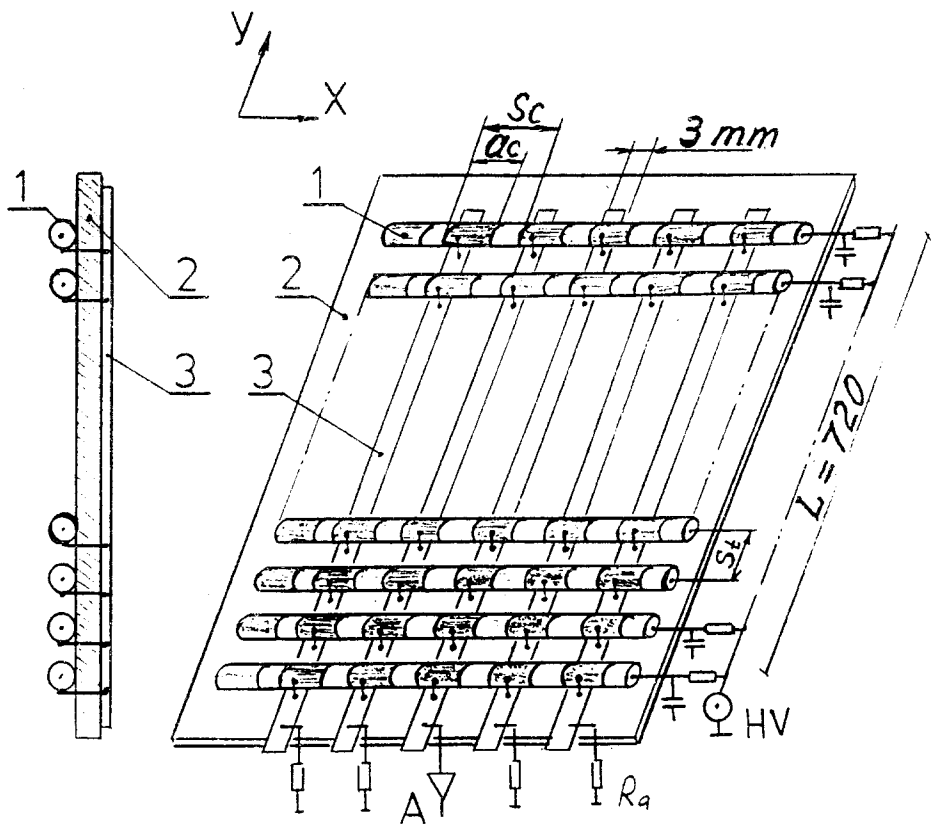

Fig.1. The layout of the prototype. 1 — straw with a_c wide ring strips; 2 — fiberglass support; 3 — strip bus for X-coordinate readout

resistance of the fast current amplifier used). The upper side of the prototypes is shielded with thin foil. Anode is 50 μ m diameter wire. The gas used was Ar/CH₄ (50/50). Flow rate was about 5 cub.cm/min. The straws were irradiated with 8 keV 1.5 mm diameter gamma particle beam through narrow windows in the shield. The X-ray tube as the source of radiation can be positioned along the straw with high accuracy.

Amplitude characteristics of each type of straw were studied in two ways: first — each strip of only one straw was connected to its bus, a few centimeters long; second — each strip of all straws was connected to 72 cm long busses of prototype.

III. CAPTON 4 mm STRAWS

Capton straws, 4 mm diameter, 90 of them, were assembled with $St = 8$ mm pitch. These straws had been developed for Transition Radiation Detector [7]. They have solid carbon coverage on both inner and outer sides with resistivity approximately 0.5 kOhm/sq. Strip rings $Ac = 0.1$ mm wide made from copper wire are placed in $Sc = 14$ mm pitch directly on the outer resistive layer of the tube. Each strip ring is connected with 3 mm strip bus, which is arranged in 15 mm pitch.

Figure 2 gives dependence of the cathode signal amplitude on the X-ray source position along the straw. The upper curve is for the single straw only. The influence of the increasing crosstalk between the adjacent strip buses is shown as the lower curve for the full prototype. The centers of the distributions correspond to the beam position in the center of the ring strip.

In [3] it is shown that the spatial resolution depends almost linearly on the signal-to-noise ratio. The lower curve in Fig.3 shows the signal cathode amplitude dependence on the X-ray beam position along the strip bus. The amplitude reduction makes the signal-to-noise degrade down to about 5 or 10 for the straws operating in proportional mode.

The small prototype with 15 capton straws only was constructed. Each straw has the isolation 1+1.5 mm wide ring in the carbon layer on the outer surface of

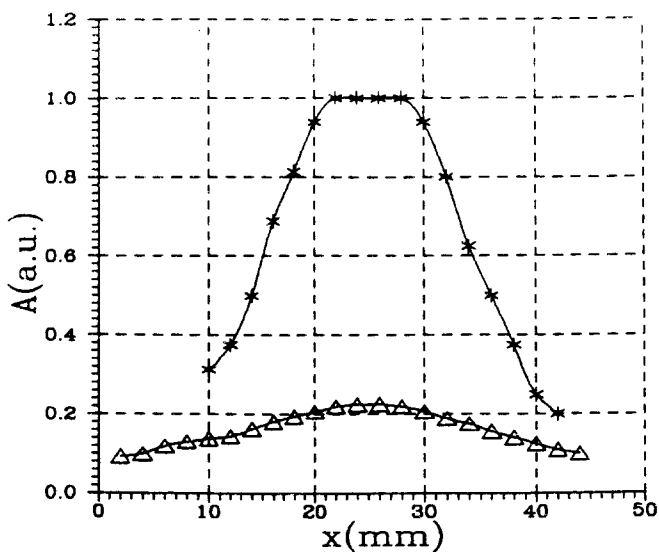

Fig.2. The distribution of cathode signals of X-ray source position along the straw. (*) — single straw; (Δ) — 90 straws

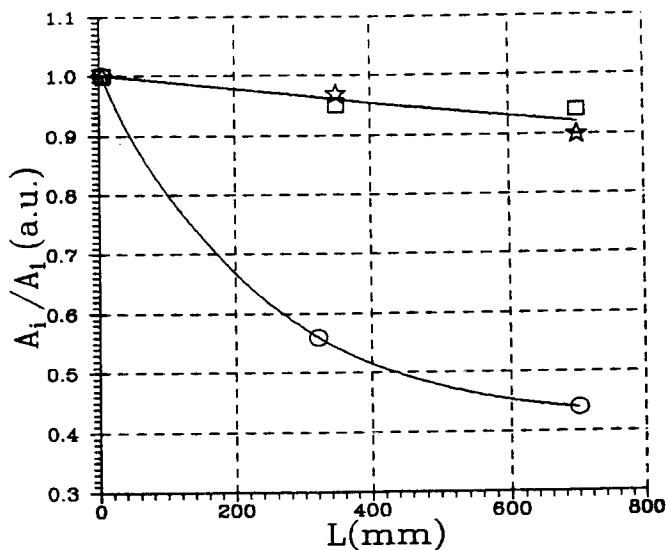

Fig. 3. The distribution of cathode signals of X-ray source position along the strip bus. (O) — 4 mm capton straws; (*, □) — 30 and 70 kOhm/sq, 10 mm diameter resistive straws

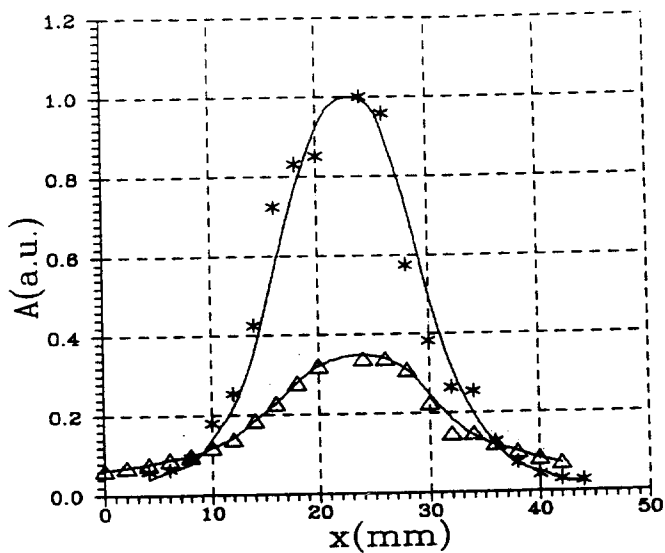

Fig. 4. The distribution of cathode signals of X-ray source position along the capton resistive stripped straw. (*) — single straw; (Δ) — 15 straws

the straw, with the pitch of about 15 mm. The 14 mm resistive ring strips were connected to the strip buses. The amplitude dependence in this case is somewhat better (Fig.4) but the production technology of such straws is complicated.

IV. MYLAR 10 mm STRAWS

The 10 mm straws were fabricated from 20 mkm thick mylar. The inner surface of the straws is covered with carbon of 0.5, 30, and 70 kOhm/sq. These tubes were inserted into aluminized mylar tubes of slightly larger diameter. The aluminium layer of the external tubes is on their outer surface. The aluminium layer makes ring strips of a_c width, and $a_c + 15$ mm pitch. The gap between carbon cathode and Al ring strips is about 40 mkm of mylar and 50 mkm of air. The capacitance between them is closed to 10 pF per one millimeter of the straw length.

IV.1 The Amplitude Dependence

Figure 5 shows the dependence of the cathode signal amplitude on the length of the ring strips. For each single straw the X-ray beam traversed the straw in the center of middle ring strip. The difference of the signal amplitude

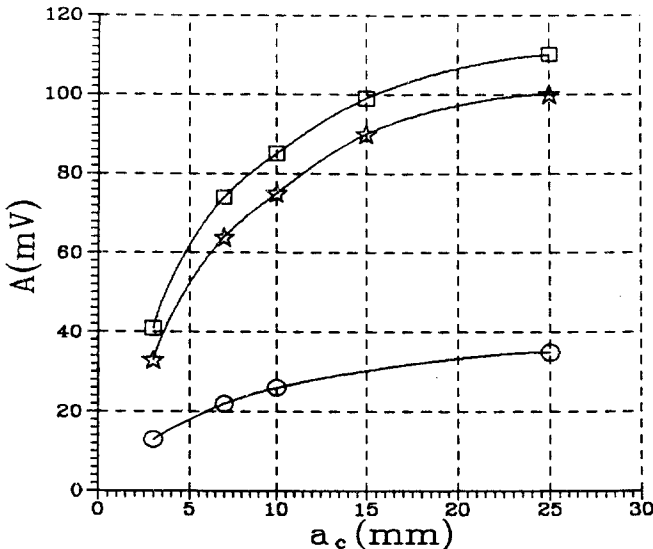
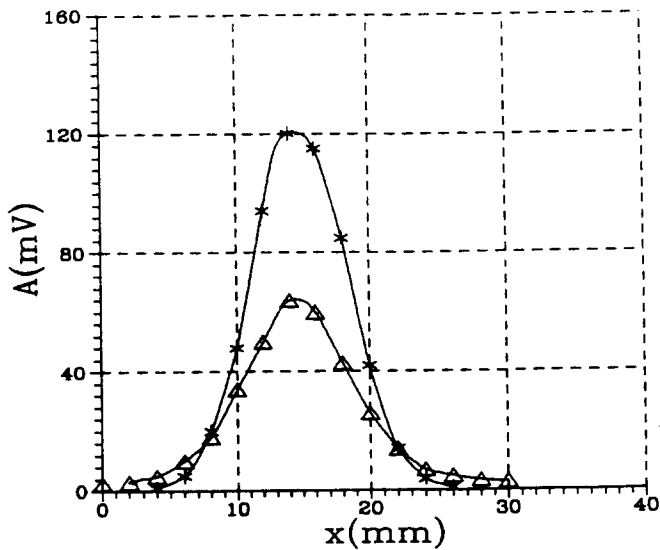
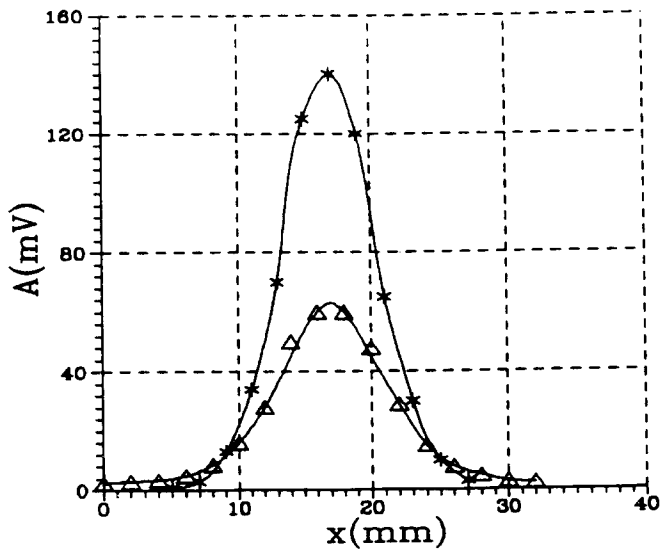

Fig.5. The dependence of the cathode signal amplitude on the length of the ring strip. (O), (*), (□) — cathode resistivity 0.5, 30, 70 kOhm/sq respectively



a)



b)

Fig. 6. The distribution of cathode signals of X-ray source position along the 10 mm diameter straw. (*) — single straw; (Δ) — 44 straws. (a), (b) — cathode resistivity 30 and 70 kOhm/sq, respectively

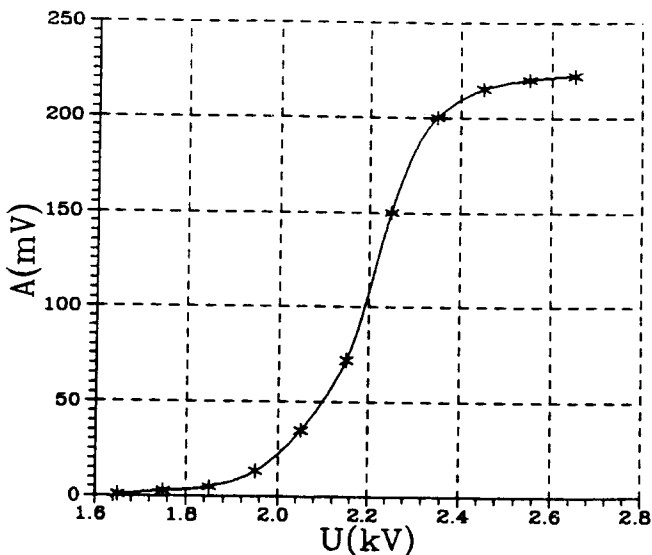

Fig.7. The cathode signal amplitude as a function of the anode high voltage. Resistive straw: 30 kOhm/sq, 10 mm diameter. Gas: Ar/CH4 (50/50)

between 70 and 30 kOhm/sq resistive straws is about 10%, but the amplitude for 0.5 kOhm/sq straws is 3 times as less. In [5] the authors investigated such dependence for 1 and 2 mm thick PVC tubes and explained the principles of the resistive cathode transparency.

We assembled two prototypes, 44 straws each, with 30 and 70 kOhm resistive strips. The geometrical parameters of the prototype are presented in the table below.

Parameters of 10 mm straw prototypes

Ac, mm	Sc, mm	St, mm	L, mm
5	6.5	15	720

Figure 6 (a, b) gives dependence of the cathode signal amplitude on the position of the X-ray beam along the 70 and 30 kOhm/sq straws, respectively. The upper curves are for single straws, the lower ones are for the whole prototypes. The crosstalk between adjacent buses reduces the signal amplitude by factor 2 and makes distribution 10% (FWHM) wider. As can be seen, the dependencies are similar. The amplitude reduction depends on the X-ray beam position along the tube very little (see upper curve in Fig.3). The signal-to-noise

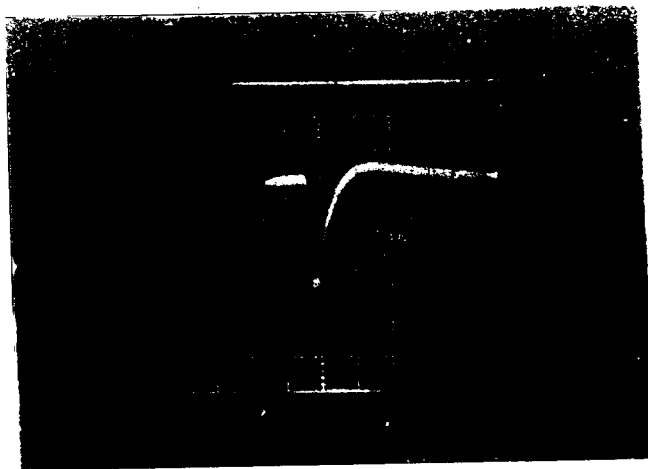

a)

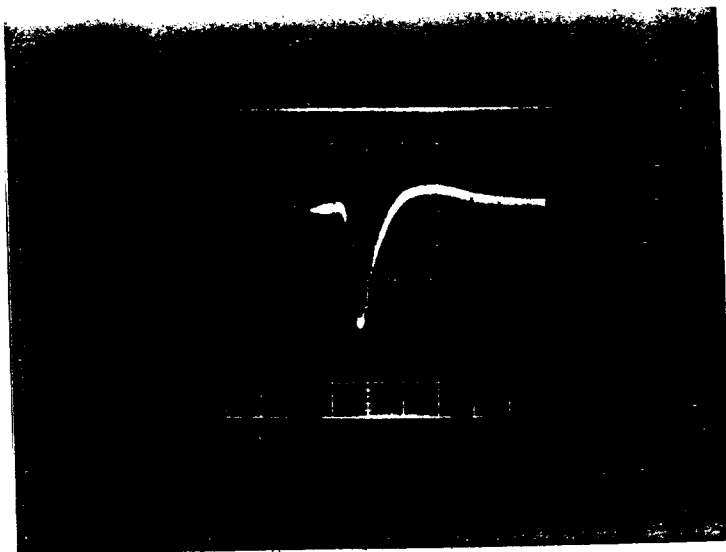

b)

Fig.8. The shapes typical anode (a), and cathode (b) signals of the full 44 straws prototype. The cathode resistivity is 30 kOhm/sq. One degree corresponds to 50 ns

ratio is high for the straws operating in proportional mode. For example, it is greater than 100 at 2.25 kV anode voltage.

Figure 7 gives the dependence of the cathode signal amplitude on the anode voltage. The 30, 70 and 0.5 kOhm/sq tubes are put in LS mode at the voltages 2.35 and 2.4 kV, respectively. The photographs of typical anode and cathode signals are shown in Fig.8a and Fig.8b, respectively.

IV.2 Lifetime and Rate Properties of 10 mm Resistive Straws

Figure 9 shows the dependencies of the anode signals on the X-ray beam intensity for different resistive straws. The signal is reduced by 40% with the intensity of 8 keV X-ray beam of about $2 \cdot 10^5$ mm/s.

The ageing effect was observed for 70 kOhm resistive straws. The X-ray beam, 15 mm diameter, traversed one of the straws in the single point in all the measurements. The straw operated in LS mode at 2.7 kV anode voltage. Figure 10 shows the dependence of the anode signal on the total charge per length unit of the anode wire. This value (Q) is determined as

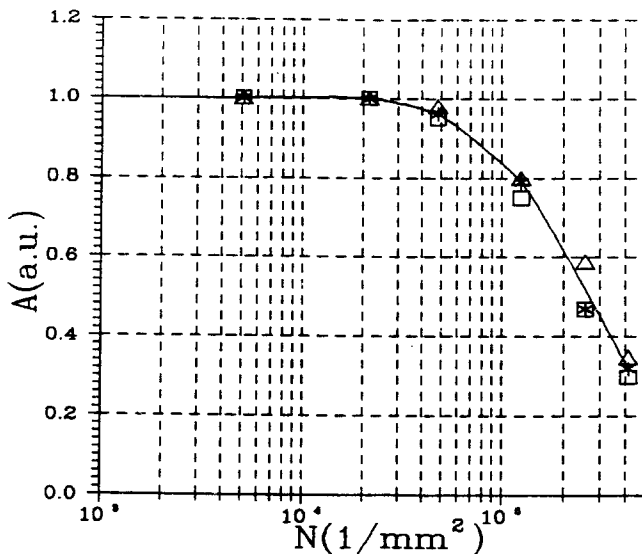

Fig.9. The dependence of the anode signal amplitude on the X-ray beam intensity. Anode voltage is 2.2 kV. (□), (*), (Δ) cathode resistivity 0.5, 30, 70 kOhm/sq, respectively

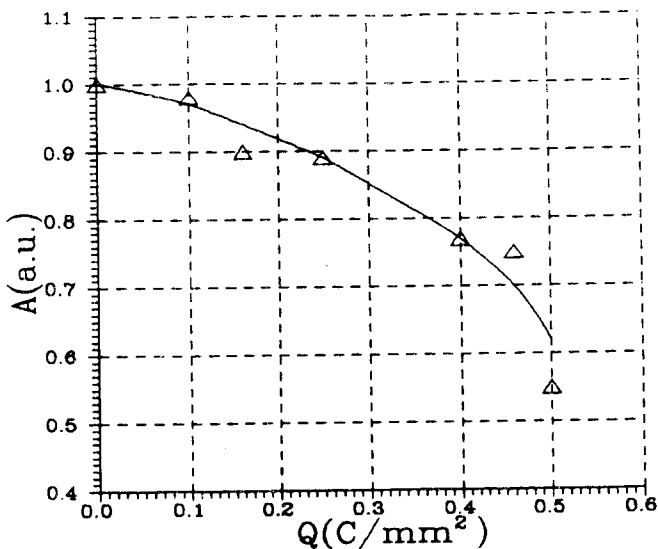

Fig.10. The dependence of the anode signal amplitude on the total collection of local charge. Anode voltage is 2.2 kV. Resistive straw: 70 kOhm/sq,

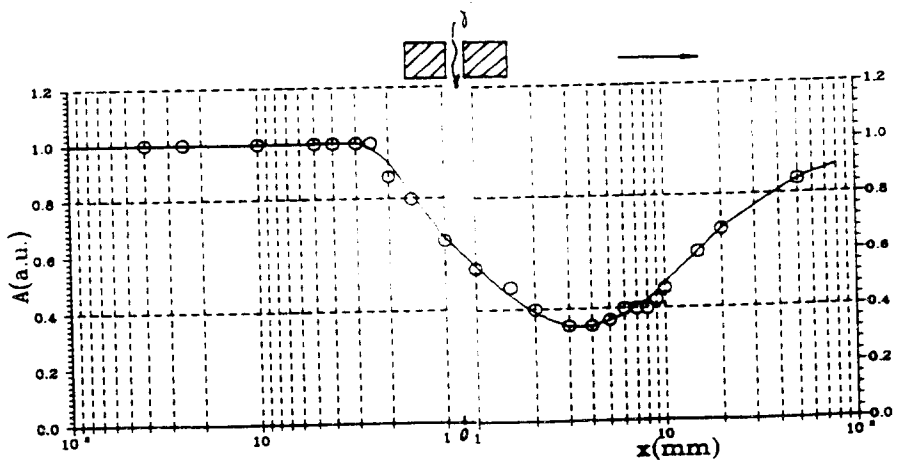

Fig.11. The dependence of the anode signal amplitude on the X-ray position near the irradiation point (X-coordinate is 0). The arrow shows the last direction of the gas flow. Anode voltage is 2.2 kV. Resistive straw: 70 kOhm/sq, 10 mm diameter

$$Q = \sum_i 1.6 \cdot 10^{-19} \cdot (A_{ai} / A_{ao}) \cdot T_i \cdot N \cdot G \cdot (E/\omega),$$

where N is X-ray beam intensity; E , energy; A_{ai} , anode signal amplitude after T_i measurement time; A_{ao} , anode signal amplitude at the start of measurement; G , gas gain. G was assumed to be 10^6 .

After the measurement we observed the decreasing of the anode signal amplitude by factor 2 in the straw region from the X-ray beam position to the gas outlet. In the rest of the straw the signal did not change. It was done using Fe-55 source. We reversed the direction of gas flow, and after a long time the effect has gone, except for the narrow region around the X-ray beam position.

After that the straw operated with smaller gas gain and charge density per time per square unit. We continued the exposition, and collected more than 1.5 C/sq. mm of the total local charge. Figure 11 shows the stability zone of the gas gain degrading. The center of the zone moved along the last direction of the gas flow. We inspected the cathode and anode with the microscope. The cathode surface was not damaged. On the wire the carbon sediment was observed. The length of the sediment was 2 to 4 mm on the opposite wire sides.

V. CONCLUSION

This investigation shows the possibility of building a large area straw chambers based on the stripped resistive straw tubes. Such detector can operate in LS or proportional modes, and in the last case the signal-to-noise ratio is about 100. The use of the fast preamplifiers allows one to reduce the charge collection time to 50—100 ns, which is better to compare with other cathode strip readout chambers.

REFERENCES

1. Straw Proportional Tubes Study for the ATLAS Inner Detector. RD6 Collaboration. CERN-PPE/94-DRAFT, Feb., 1994.
2. Ash W.W. et al. — Nucl. Instr. Meth., 1987, A 261, p.399.
3. Bychkov V.N. et al. — Nucl. Instr. Meth., 1993, A 325, p.158.
4. van der Graaf H. et al. — Nucl. Instr. Meth., 1991, A 307, p.220.
5. Battistoni G. et al. — Nucl. Instr. Meth., 1982, A 202, p.459.
6. Shin T.S. et al. — Nucl. Instr. Meth., 1993, A 332, p.469—475.
7. Dolgoshein B. — Nucl. Instr. Meth., 1993, A 326, p.434.

Received by Publishing Department
on August 30, 1994.

SUBJECT CATEGORIES OF THE JINR PUBLICATIONS

Index	Subject
1.	High energy experimental physics
2.	High energy theoretical physics
3.	Low energy experimental physics
4.	Low energy theoretical physics
5.	Mathematics
6.	Nuclear spectroscopy and radiochemistry
7.	Heavy ion physics
8.	Cryogenics
9.	Accelerators
10.	Automatization of data processing
11.	Computing mathematics and technique
12.	Chemistry
13.	Experimental techniques and methods
14.	Solid state physics. Liquids
15.	Experimental physics of nuclear reactions at low energies
16.	Health physics. Shieldings
17.	Theory of condensed matter
18.	Applied researches
19.	Biophysics

Бычков В.И. и др.

E13-94-351

Стриповое считывание координатной информации
с тонкопленочных резистивных дрейфовых трубок

Исследованы прототипы дрейфовой камеры на основе тонкопленочных дрейфовых трубок с катодным считыванием. В качестве материала для дрейфовых трубок использован майлар с углеродным покрытием резистивностью от 0.5 до 70 кОм/квadrat. Камеры продувались газовой смесью Ar/CH₄. Характеристики камер исследовались с помощью рентгеновской трубки: регистрировались как катодные, так и анодные сигналы.

Работа выполнена в Лаборатории сверхвысоких энергий ОИЯИ.

Препринт Объединенного института ядерных исследований. Дубна, 1994

Bychkov V.N. et al.

E13-94-351

Cathode Readout with Stripped Resistive Drift Tubes

A straw tube drift chamber prototype has been constructed and tested. The straw tube material is mylar film covered with carbon layer of resistivity 0.5, 30 and 70 kOhm/sq. The gas mixture used was Ar/CH₄. Both the anode wire and cathode signals were detected in order to study the behaviour of the chamber in the presence of X-ray ionization. The construction and the results of the study are presented.

The investigation has been performed at the Laboratory of Particle Physics, JINR.

Preprint of the Joint Institute for Nuclear Research. Dubna, 1994

Редактор Э.В.Ивашкевич. Макет Р.Д.Фоминой

Подписано в печать 21.10.94
Формат 60×90/16. Офсетная печать. Уч.-изд.листов 1,05
Тираж 355. Заказ 47656. Цена 189 р.

Издательский отдел Объединенного института ядерных исследований
Дубна Московской области