

A MULTIPURPOSE SCINTILLATING FIBRE BEAM MONITOR FOR THE MEASUREMENT OF SECONDARY BEAMS AT CERN

I. Ortega Ruiz*, L. Fosse, J. Franchi, A. Frassier, J. Fullerton, J. Kral, J. Lauener, T. Schneider, J. Spanggaard, G. Tranquille, CERN, 1211 Geneva, Switzerland

Abstract

A scintillating fibre beam monitor has been developed at CERN for the measurement of low energy and low intensity secondary beams. This monitor can track the passage of individual particles up to intensities of 10^7 particles per second per mm^2 , over an active area of $\sim 20 \text{ cm} \times 20 \text{ cm}$, and with a spatial resolution of 1 mm. Thanks to an external trigger system, the achieved detection efficiency is $\sim 95\%$ and the noise level is kept below 10^{-4} events/second. The simple design of this monitor avoids the common production difficulties of scintillating fibre detectors and makes its maintenance easier, when compared to other tracking detectors, due to the absence of gas or cooling. Using special electronics, a version of the monitor can also be used for time-of-flight measurements, achieving a time resolution of 900 ps. Thanks to its versatility, the monitor will perform several functions when measuring the secondary beams of the CERN Neutrino Platform: beam profile measurement, magnetic momentum spectrometry, particle identification through time-of-flight, and trigger generation for the experiments.

INTRODUCTION

The Experimental Areas at CERN deliver beams of secondary particles that are used by many experiments related to high-energy physics research and R&D in particle detectors and accelerator technology. These beams are composed of hadrons and leptons that are delivered over a wide range of energies (1 GeV/c to 450 GeV/c), and intensities (10^2 to 10^7 particles per second per mm^2). The profile and position of these beams have been measured for decades with Multi-Wire Proportional Chambers and Delay Wire Chambers. However, these detectors are ageing, which compromises their performance, and they cannot fulfil the requirements of a new experimental area, the Neutrino Platform, since it requires large area monitors capable of detecting individual particles [1, 2].

For these reasons, the Beam Instrumentation group at CERN has investigated a new scintillating fibre beam monitor, whose first prototype was successfully tested with beam as reported in [3, 4]. This article describes the second prototype, which has the code name XBPF (eXperimental Beam Profile Fibre monitor), and the beam tests that have validated its production for the Neutrino Platform. Twelve monitors will be commissioned in this facility at the end of August 2018, at the same time as the new beam lines.

* inaki.ortega@cern.ch

XBPF AND XBTF

The XBPF for the Neutrino Platform is composed of 192 scintillating fibres Kuraray SCSF-78 of 1 mm thickness and square cross section. The fibres are packed together along one plane, forming the active area of the detector that stands in front of the beam (Fig. 1). The light from every fibre is read-out on one end by an individual Silicon Photomultiplier (SiPM) from Hamamatsu (model S13360-1350) that allows one to know which fibre has been activated and subsequently to reconstruct the track of the particle from multiple monitors. A mirror glued on the non read-out end of the fibre reflects back the light travelling in that direction along the fibre, thus increasing the total light signal reaching the photomultiplier.

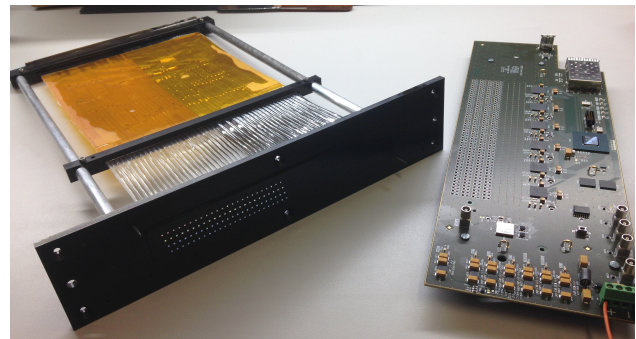

Figure 1: XBPF on the left, and front-end board with the 192 SiPMs on the right.

There exists a second version of the monitor, the XBTF (eXperimental Beam Trigger Fibre monitor), that is used to produce a fast trigger for the XBPF and for the neutrino experiments. In this monitor the fibres are grouped together into two bundles to be read-out by two Photo Multiplier Tubes (PMT) H11934-200 from Hamamatsu. These PMT have a very low dark count rate, at the level of a few Hz, and also have a low transit time spread (300 ps), which makes them suitable for Time-of-Flight applications.

Both the XBPF and XBTF have been designed to be vacuum compatible, which removes the need for vacuum windows, so helping to reduce the material budget of the beam line. The photo detectors are located outside vacuum, with the fibres exiting via a feed-through based on an innovative gluing technique that guarantees the necessary leak tightness. The vacuum tank of the new detectors has a modular design that allows it to host any desired combination of XBPF and XBTF, chosen to optimise the functionality of the beam line (Fig. 2).

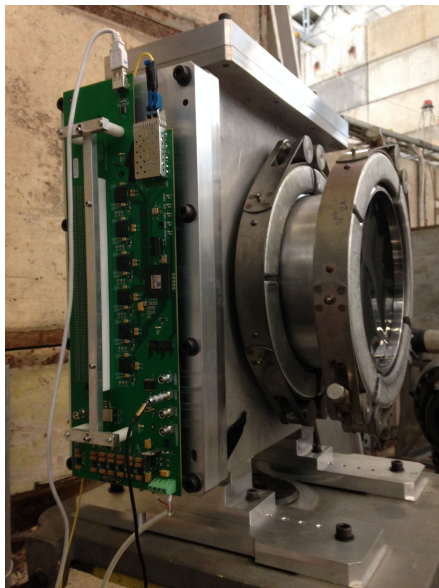

Figure 2: Vacuum tank of the XBPF during installation, with a front-end electronics board in place.

READOUT ELECTRONICS

The electronics architecture of the XBPF and XBTF is shown in Fig. 3. For the XBTF trigger, the acquisition chain is very simple. The analogue signals from the PMT travel directly over a coaxial cable to a rack in the experimental hall, where they are processed by a NIM discriminator and a logic module. This logic module creates a coincidence of several trigger modules in the beam line and the resulting signal is sent to the XBPF profile monitors and the neutrino experiments with the aim of triggering their acquisition.

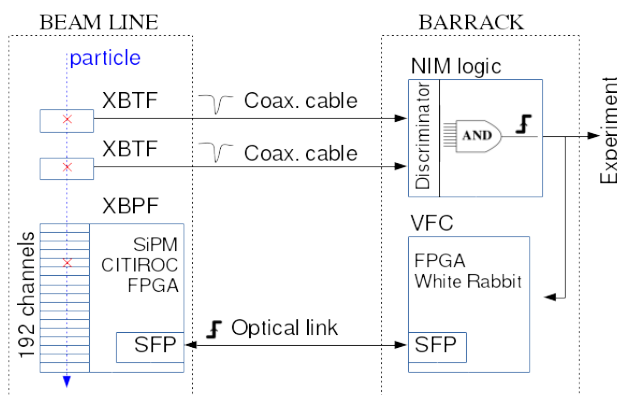

Figure 3: Electronics architecture of the XBPF and XBTF.

The XBPF electronics are divided into a front-end board, plugged directly on the monitor, and a back-end board grouped in a central acquisition chassis in the experimental hall. The front-end board has the following main components:

- 192 SiPM that detect the light generated by the fibres.
- Hamamatsu C11204 power supply, which powers up the SiPM and also features a temperature compensation

feedback system in order to maintain a stable gain in the photodetectors.

- 6 CITIROC ASIC [5] that process the analogue signals from the SiPM. These chips convert the 192 SiPM signals to digital signals in parallel, via configurable discriminators. It also features additional functionalities, such as fine tuning of the SiPM voltage and adjustable pre-amplification of the input signals.
- Xilinx FPGA Artix 7 that configures CITIROC slow control, reads the CITIROC digital output, packages the data, and sends it out in a 10 MHz data stream to a Gbit transceiver.
- SFP module with Gbit transceiver to transfer the data via optical fibre to the back-end.

The back-end module is the VFC, a VME general purpose digital acquisition board developed by the CERN Beam Instrumentation group [6]. This board is fully compatible with White Rabbit, which is an Ethernet-based network for sub-nanosecond accuracy timing distribution [7]. The Neutrino Platform experiments use this technology as their general timing distribution network and the beam instrumentation was required to be compatible.

The main functions of the VFC are to decode the Gbit stream coming from the front-end, to send control data to the front-end, and to create and store the event structure. The data stream from the front-end includes both the information from real particles and the noise from the SiPM, which can be at a rate of several kHz when considering all 192 channels. In order to suppress the noise events, the VFC also receives a trigger signal from the XBTF and only records the events coinciding with that signal.

The acquisition and control software of the XBPF is based on the CERN FESA architecture [8]. Every recorded event has the information of the status of the 192 fibres (hit, no-hit), plus a timestamp of when the event occurred.

Time-of-Flight

It is possible to use the fast signals of the XBTF to measure the Time-of-Flight (ToF) of the particles from one trigger to another. This feature is very interesting, since it allows the particle composition of the beam to be determined. The figure of merit in a ToF system is the time resolution, which is given by the cumulative effect of the time spread of the following processes:

- Light creation process in the fibre.
- Different path lengths of photons inside the fibre.
- Transit time spread of electrons in the PMT.
- Time walk of the discriminator.
- Resolution of the Time-to-Digital Converter (TDC).

Content from this work may be used under the terms of the CC BY 3.0 licence (© 2018). Any distribution of this work must maintain attribution to the author(s), title of the work, publisher, and DOI.

The analogue signals from the PMT are discriminated by a Constant Fraction Discriminator (CAEN N842) as this type of discriminator minimises the jitter of the signals [9]. The discriminated digital signals then go to a special TDC, the FMC-TDC developed at CERN, which has a resolution of 81 ps and is White Rabbit compatible. The model of CFD used, however, is not ideal since it has a long time walk (400 ps), when compared to other discriminators in the market. It also produces NIM signals that must be converted to TTL logic level before being sent to the TDC, increasing therefore the time jitter of the system.

BEAM TESTS OF THE XBPF

Two XBPF and two XBTF were tested during two weeks in November 2017 in the East Area experimental facility at CERN. The beam conditions were chosen to be similar to the future Neutrino Platform: beams of low momentum (1 GeV/c to 6 GeV/c) and intensities between 10^3 and 10^5 particles per second.

As can be seen in Fig. 4, two tanks were installed separated by 14 m, hosting one XBPF and one XBTF each. The XBPF in the upstream tank measured the horizontal profile of the beam and the XBPF in the downstream tank, the vertical profile. The trigger signal was created from the coincidence of both XBTF. The upstream tank was installed close to two standard monitors: a delay wire chamber (DWC) for profile reconstruction and a scintillator paddle (SCINT) for intensity measurements. This allowed direct comparisons with the XBPF to be made.

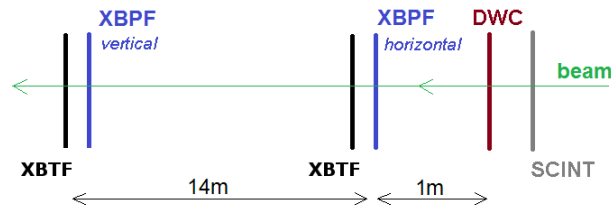

Figure 4: Schematic of the East Area beam test layout.

Results and Discussion

A direct comparison of the DWC and XPBF profiles immediately shows that the latter produces more accurate profiles (Fig. 5).

Since the information from all fibres is recorded for a given event, it is possible to study performance characteristics of the detector, such as the efficiency or the multiplicity. Multiplicity occurs when multiple fibres are activated during the sampling time of the electronics (100 ns) such that they are recorded in the same event. Figure 6 shows an example of such a fibre-hit analysis.

The efficiency (which can be easily calculated from the number of multiplicity 0 events - a trigger giving no hits in the XBPF) was measured systematically for many different beam conditions for both the upstream and downstream

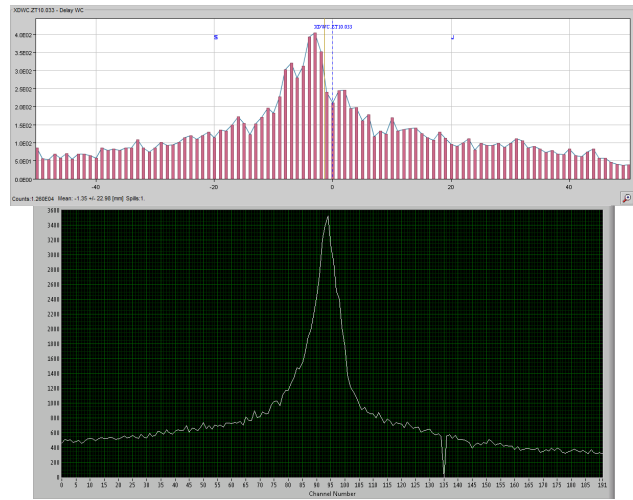

Figure 5: Example of a horizontal profile of a -6 GeV/c pion beam of $I = 1.5 \times 10^5$ particles measured by the DWC (above) and the XBPF (below).

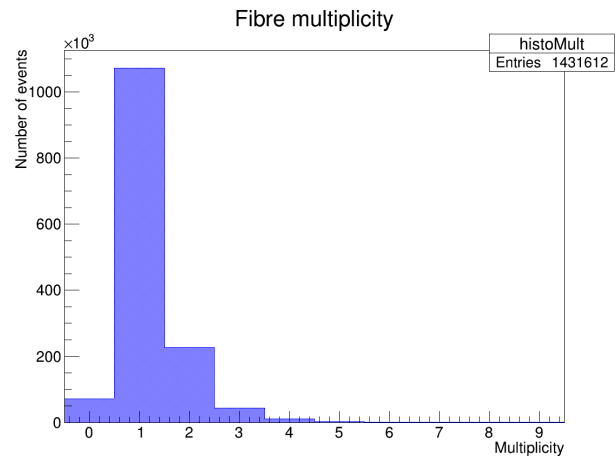

Figure 6: Example of fibre-hit analysis for a beam of -6 GeV/c pions.

XBPF:

$$\epsilon_{\text{upstream}} = 93.8 \pm 2.8\% \quad (1)$$

$$\epsilon_{\text{downstream}} = 84.0 \pm 7.9\% \quad (2)$$

The lower efficiency of the downstream detector could be explained by a non-ideal configuration of the system. Unfortunately, this analysis was only completed after the end of the beam tests and therefore this issue was identified too late. Subsequent measurements performed with the XBPF working as a cosmic ray telescope in the laboratory (Fig. 7), however, have allowed optimum configuration values to be found. With such optimisation, the measured efficiency is:

$$\epsilon_{\text{telescope}} = 94.9 \pm 0.8\% \quad (3)$$

Fibre multiplicity during the beam tests ranged from 4.2% to 39%, and were lower for focused beams. The most plausible explanation is therefore that multiplicity is mainly caused

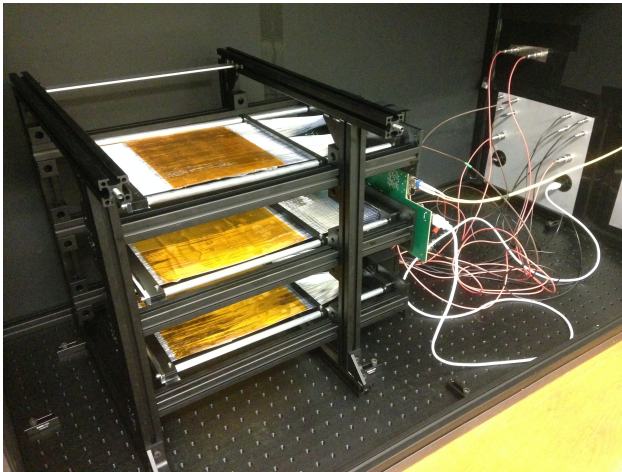

Figure 7: The XBPF working as a cosmic ray telescope.

by particles that impact the detector with large angles, activating two adjacent fibres. Measurements with the cosmic ray telescope and a Monte Carlo simulation have helped to confirm that the majority of multiplicity-two events are caused by such particles. The remaining multiplicity events are believed to be caused by particle showers arriving within the sampling time of the electronics.

The performance of the upstream XBTF could be measured more accurately thanks to having access to the adjacent scintillator paddle signal. By placing the paddle in coincidence with the downstream XBTF, it was possible to measure the particle flow through the upstream XBTF, and consequently measure its efficiency. After tuning the threshold of the discriminator, the efficiency was measured to be:

$$\varepsilon_{\text{XBTF}} = 94.0 \pm 0.1\% \quad (4)$$

Figure 8 shows an example of time-of-flight measurement for a 2 GeV/c beam containing a mixture of pions and protons. The measured time resolution of the ToF system was:

$$\sigma_t \sim 900 \text{ ps} \quad (5)$$

Thanks to this time resolution, it was possible to identify, within a short distance of 14 m, the pions and protons from 0.5 GeV/c to 2.5 GeV/c, with a statistical significance of 4σ .

CONCLUSION AND OUTLOOK

The XBPF has shown an excellent performance in the recent East Area tests and in the cosmic ray telescope setup. It has tracked, particle by particle, secondary beams and cosmic rays up to intensities of 10^5 particles per second over a wide range of energies. Furthermore, with the addition of a suitable TDC, the XBTF has been shown to be capable of measuring the time of flight of beam particles with a time resolution of 900 ps.

A modification of the VFC firmware is currently being investigated to allow the triggering of the acquisition by putting two XBPF planes in coincidence. This cross-trigger

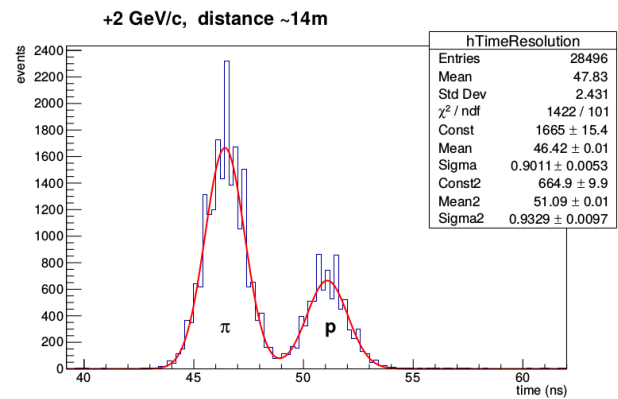

Figure 8: Time-of-flight measured for a 2 GeV/c pion-proton beam over a distance of 14 m.

mode would avoid requiring the XBTF, meaning that a pair of horizontal and vertical XBPF would be sufficient to accurately measure the beam.

The use of different constant fraction discriminators for the ToF system is also under investigation, which could lead to a possible improvement of the time resolution for the Neutrino Platform experiments.

ACKNOWLEDGEMENTS

The authors would like to thank Wilfried Devauchelle for his invaluable help during the design, production, installation, and commissioning of the new monitor, and also Matthias Raudonis for his investigations in the cross-trigger acquisition mode of the XBPF.

REFERENCES

- [1] N. Charitonidis, I. Efthymiopoulos, and Y. Karyotakis, "Beam performance and instrumentation studies for the protodune-dp experiment of cenf," *arXiv preprint arXiv:1607.07612*, 2016.
- [2] N. Charitonidis, I. Efthymiopoulos, and Y. Karyotakis, "Addendum to ats note cern-acc-note-2016-0052," CERN, Tech. Rep., 2016.
- [3] I. Ortega Ruiz, G. Tranquille, J. Spanggaard, A. Bay, and G. Haefeli, "Jacow: A scintillating fibre beam profile monitor for the experimental areas of the sps at cern," 2017.
- [4] I. Ortega Ruiz, "Accurate profile measurement of the low intensity secondary beams in the cern experimental areas," PhD thesis, Ecole Polytechnique, Lausanne, 2018.
- [5] J. Fleury *et al.*, "Petiroc and citiroc: Front-end asics for sipm read-out and tof applications," *J. Instrum.*, vol. 9, 2014.
- [6] A. Boccardi, M. Barros Marin, T. Levens, B. Szuk, W. Viganò, and C. Zamantzas, "A modular approach to acquisition systems for future cern beam instrumentation developments," *CERN*, 2015.
- [7] J. Serrano *et al.*, "The white rabbit project," *CERN*, 2013.
- [8] A. Guerrero, J. Gras, S. Jackson, J. Nougaret, M. Arruat, and M. Ludwig, "Cern front-end software architecture for accelerator controls," Tech. Rep., 2003.
- [9] D. Gedcke and W. McDonald, "Design of the constant fraction of pulse height trigger for optimum time resolution," *Nuclear Instruments and Methods*, vol. 58, no. 2, pp. 253–260, 1968.