

Content from this work may be used under the terms of the CC BY 3.0 licence (© 2019). Any distribution of this work must maintain attribution to the author(s), title of the work, publisher, and DOI

IMPACT OF FLUX JUMPS ON HIGH-PRECISION POWERING OF Nb₃Sn SUPERCONDUCTING MAGNETS*

Michele Martino^{1†}, Pasquale Arpaia^{1,2}, Stefano Ierardi^{1,2}
¹CERN, Geneva, Switzerland
²Universita' di Napoli Federico II, Naples, Italy

Abstract

Nb₃Sn superconducting magnets represent a technology enabler for future high-energy particle accelerators. A possible impediment, though, comes from flux jumps that, so far, could not be avoided by design unlike for NbTi technology. However, the impact of flux jumps on the magnet powering has not been properly investigated to date. Flux jumps appear during current ramps at relatively low value of current and tend to disappear towards nominal current. They are usually detected as voltage jumps between different magnet coils but they might also produce overall voltage jumps across the magnet electrical terminals. Such jumps might perturb the power converter feedback control loop and therefore potentially jeopardize its precision performance during energy ramps. This work aims at: (i) presenting preliminary experimental test results on some HL-LHC Nb₃Sn model and prototype magnets, and (ii) attempting to build a simplified electrical model of the flux jumps, with focus only at its interaction with the power converter feedback control loop. Such a work is a starting point for outlining possible power converters control strategies able to minimize flux jumps impact on high-precision powering of Nb₃Sn superconducting magnets.

INTRODUCTION

Nb₃Sn superconducting magnets represent a technology enabler for future high-energy particle accelerators. A possible impediment, though, comes from flux jumps. For instance, quench protection systems must be able to discriminate them from quench events (not to trigger non-necessary actions), however the impact of flux jumps on the powering has not been properly investigated to date so no available models can be used for its estimation.

A first *behavioural* model is presented in the following and illustrated by means of a case study: the 11 T magnet to be installed in LHC during LS2 (Long Shutdown 2).

Flux jumps appear during current ramps at relatively low value of current and tend to disappear towards nominal current [1–4]. In this work, no attempt will be made at investigating their amplitude and frequency of occurrence as a function of the current level, because this does not really matters for the powering even though it is very relevant for quench protection systems that can exploit, as an example, the dependence of flux jumps amplitude on the current level to adapt the quench detection thresholds as current is ramping up. What really matters, for the scope of this study, is

* Research supported by the HL-LHC project.

† michele.martino@cern.ch

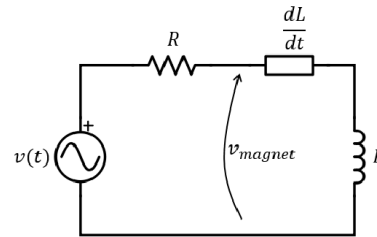

Figure 1: Circuit model: flux jumps as fluctuating inductance.

the amount of perturbation generated by the flux jump occurrence on the current (of the power converter). In this respect, a worst case analysis is justified. Flux jumps will be looked at only from the point of view of the power converter, where the *observables* are circuit current and magnet voltage, such as shown in Fig. 1 and Eq. (1).

Preliminary tests on MQXFS4b (short model of the MQXFB magnets for the Inner Triplet of HL-LHC) and on the first prototype of the 11 T magnet (Fig. 2), highlighted that the control parameters of the digital feedback loop of the power converter affect the spectra of the above mentioned observables. Furthermore, conversely the spectra of the signals representative of the flux jumps are unaffected. Therefore, they are hereby considered as their *spectral signature* (i.e. representative of the physics of the flux jumps themselves). The proposed modelling aims then at reproducing such spectra.

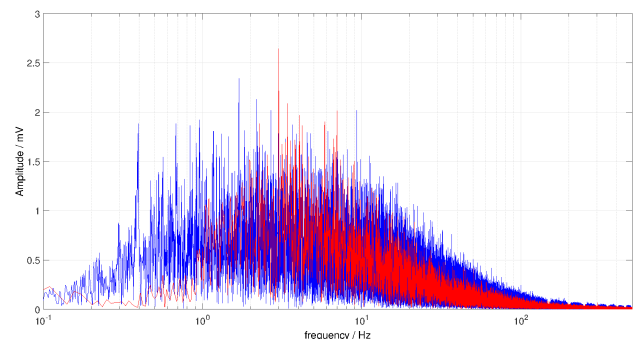

Figure 2: Spectra of the flux jumps signals acquired, at 1.9 K, from: (i) the 11 T prototype magnet, at one of the apertures, magnified by a factor 10 × (blue) with a ramp rate of 10 A s⁻¹, and (ii) the MQXFS4b model magnet (red) with a ramp rate of 51 A s⁻¹.

This is a preprint — the final version is published with IOP

INDUCTANCE JUMP MODEL

In spite of the complexity of their *physics*, superconducting magnets are usually modelled as two-terminal *ideal* inductors for what concerns their interface with power converters. Analogously, even if flux jumping is a rather complex phenomenon, a simple lumped parameter model is sought here. A simple assumption is made here: flux jumps are the effect of inductance fluctuations, or inductance *jumps*. When inductance changes over time (assuming no non-linearity due to the current) the circuit equation becomes:

$$v(t) = Ri(t) + v_{magnet}(t) = Ri(t) + \frac{dL(t)}{dt}i(t) + L(t)\frac{di(t)}{dt} \quad (1)$$

which can be also represented as the equivalent circuit in Fig. 1. This is valid in general, but the focus here is on the ramp up of the current when flux jumps appear, so $\frac{di}{dt}$ can be assumed constant (and equal to the nominal ramp rate).

Furthermore the following is assumed:

- inductance *jumps*, as the flux jumps themselves, can be modeled as a Poisson process $N(t)$ where N is the number of *jumps* or events at time t (when count starts at $t = 0$);
- as such, a single parameter λ is enough to describe their occurrence, where $E[N(t)] = \lambda t$;
- λ is likely to be a function of the ramp rate, but this aspect is not investigated here;
- for simulation purposes $N(t)$ is *sampled* every T_s seconds, this is equivalent to a Bernoulli process for which the probability of a jump happening is $p = \lambda T_s$;
- at the time instants t_k (when the Bernoulli random generator simulates a jump happening) the inductance (of a single coil ij of the magnet) suddenly decreases (in a time T_s) by a random amount dL_k^{ij} and then recovers with a longer time constant (to reproduce what is observed experimentally) which is assumed also to be a random variable (RV).

This model of inductance jumping is graphically depicted in Fig. 3. Each *jump* can be a very tiny fraction of the overall inductance, however the time derivative can be significant. Furthermore, when looking at the voltage, this values is multiplied by the circuit current, which can be of few kA. Finally, when the $\frac{dL}{dt}$ is non-zero, this represent a dissipative term (with corresponding active power being involved).

11 T MODEL

The proposed model is illustrated by the electrical representation of the 11 T magnet in Fig. 4.

Experimentally flux jumps are observed as sudden fluctuations of the voltages V_{fji} . These are produced by the jumps in the inductance of each individual coil L^{ij} at time t_k .

The amplitude of these jumps is expressed by eq. (2).

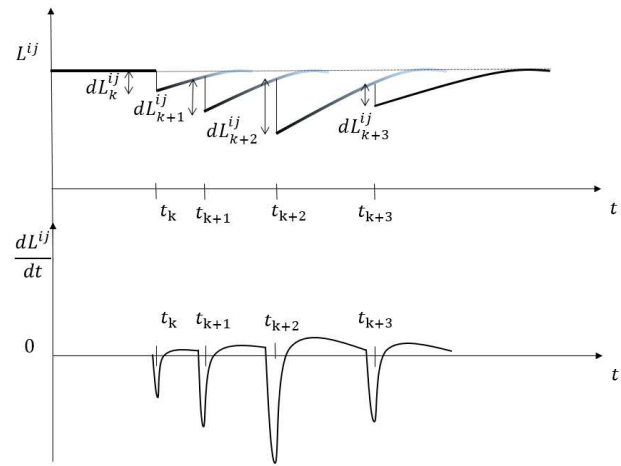

Figure 3: Inductance jumps model.

$$\frac{\Delta L_k^{ij}}{T_s} = -\frac{|X_k^{ij}|}{i'_{ref}} \quad (2)$$

The RVs X_k^{ij} are assumed having the same, Gaussian, distribution: $X_k^{ij} \sim \mathcal{N}(0, \gamma_x^2)$.

The amplitude of the jumps is normalized to the current value in order not to produce larger flux jumps at increasing current. This is a rather strong assumption; however, it is deemed sufficient for the scope of this work to be able to simulate the effect of the phenomenon on the current regulation operated by the power converters. Furthermore, experimentally, flux jumps appear in a given range of current during the ramp up and their amplitude does not increase with the current. Finally, numerical issues at low current are avoided by choosing $i'_{ref} = \max(i_{ref}, 500 \text{ A})$. The threshold of 500 A is arbitrary, but does not have implications for the scope of this work. Furthermore, the notation i_{ref} is used here to signify that the magnet is supplied by an ideal current generator.

Finally to reproduce the observed spectra of the signals $V_{fji}(t)$, as shown in Fig. 6, the generated inductance jumps (of each coil) go into a band-pass filter to produce the $\frac{d}{dt}L^{ij}(t)$ as illustrated in Fig. 5.

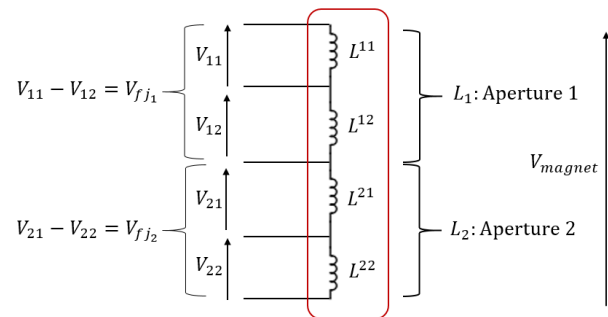

Figure 4: 11 T magnet: electrical representation.

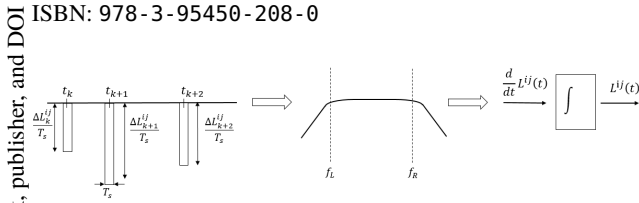

Figure 5: Inductance jumps generator.

COMPARISON WITH EXPERIMENTAL RESULTS

For the simulation, a ramp rate of 10 A s^{-1} is considered in order to match the experiments (this also corresponds to the nominal ramp rate of the LHC main dipole circuit). As already stated, the aim is reproducing the observed spectra of the $V_{fj}(t)$, thus, an ideal reference current is considered: $i_{ref}(t) = 10 t$.

A fixed fall time of $T_s = 1 \text{ ms}$ is always assumed for the inductance jumps, whereas the recovery time is simulated as a RV, sampled every NT_s main sampling instants, by letting the right cut-off frequency f_R be a log-normal RV. The corresponding parameters are reported in Table 1.

Table 1: Flux Jumps Generator Parameters

Parameter	Value
T_s : main sampling period	1 ms
λ : Rate of inductance jumps	3.4 s^{-1}
γ_X : Standard deviation of X	1.08 V
f_L : Low cut-off frequency	1.13 Hz
f_R : High cut-off frequency	$\ln(f_R) \sim \mathcal{N}(\mu_Y, \sigma_Y^2)$
σ_Y : Standard deviation of Y	0.59 Hz / Hz
μ_Y : Mean of Y	1.74 Hz / Hz
NT_s : f_R relative sampling rate	500 s / s

All parameters were tuned manually in order to match the simulated spectra of the flux jumps to the observed ones. Two spectra were measured on the 11 T prototype in December 2018, with different rms values. Hereby, in Fig. 6, they are compared with the aperture having the higher rms value of about 6 mV. Figure 6 shows in blue the spectrum of the measured $V_{fj}(t)$ and in red the spectrum obtained in simulation by means of the manually tuned inductance jumps generator. For the scope of this work, the agreement between measured and simulated spectra is deemed pretty satisfactory. Time domain data are presented in Fig. 7, with the same color convention.

CONCLUSION AND FUTURE WORK

A model able to reproduce the spectral signature of flux jumps has been proposed with satisfactory preliminary results of identification and validation experiments. Future work will consist in exploiting such a model to analyze the impact of flux jumps on the precision performance of power converters with the aim at optimizing power converters digital controller (to possibly minimize the impact of flux jumps).

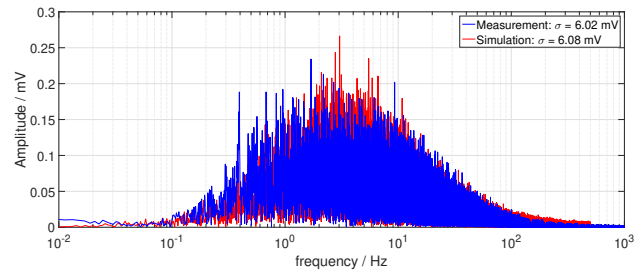

Figure 6: Simulation and measurement results in frequency domain.

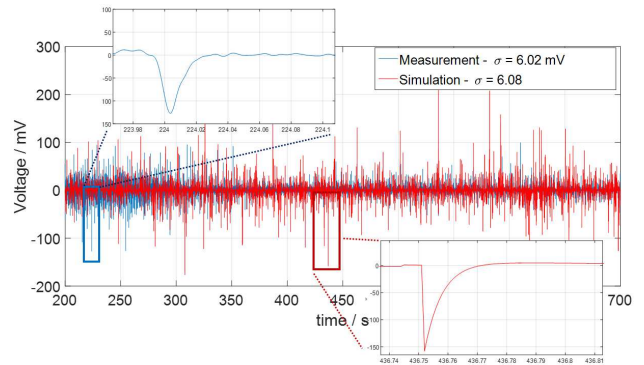

Figure 7: Simulation and measurement results in time domain.

ACKNOWLEDGMENT

Authors would like to thank Lucio Fiscarelli and Luca Bottura of TE Department for their insight and the useful discussions.

REFERENCES

- [1] S. Feher, B. Bordini, R. Carcagno, A. Makulski, D. F. Orris, Y. M. Pischalnikov, C. Sylvester, M. Tartaglia, J. C. Tompkins, and A. V. Zlobin, "Sudden flux change studies in high field superconducting accelerator magnets," *IEEE Transactions on Applied Superconductivity*, vol. 15, no. 2, pp. 1591–1594, Jun. 2005.
- [2] B. Bordini, G. Ambrosio, E. Barzi, R. Carcagno, S. Feher, V. V. Kashikhin, M. J. Lamm, D. Orris, M. Tartaglia, J. C. Tompkins, D. Turrioni, R. Yamada, and A. V. Zlobin, "Voltage spikes in Nb₃Sn and NbTi strands," *IEEE Transactions on Applied Superconductivity*, vol. 16, no. 2, pp. 366–369, Jun. 2006.
- [3] S. Rahimzadeh-Kalaleh, G. Ambrosio, G. Chlachidze, C. Donnelly, and M. Tartaglia, "Analysis of voltage spikes in superconducting Nb₃Sn magnets," *IEEE Transactions on Applied Superconductivity*, vol. 19, no. 3, pp. 2442–2445, Jun. 2009.
- [4] P. Bruzzone, S. March, K. Sedlak, B. Stepanov, R. Wesche, and D. Uglietti, "Collective Flux Jumps observed during operation of the EDIPO Magnets," *IEEE Transactions on Applied Superconductivity*, vol. 25, no. 3, pp. 1–4, Jun. 2015.

Content from this work may be used under the terms of the CC BY 3.0 licence (© 2019). Any distribution of this work must maintain attribution to the author(s), title of the work, publisher, and DOI

This is a preprint — the final version is published with IOP