

V
V
CERN LIBRARIES, GENEVA



SCAN/9408011

E9-94-94

30 94 32

E.L.Saldin*, V.P.Sarantsev, E.A.Schneidmiller*,
Yu.N.Ulyanov*, M.V.Yurkov

APPLICATION OF QUASI-OPTICAL APPROACH
TO CONSTRUCT RF POWER SUPPLY
FOR TeV LINEAR COLLIDERS

Submitted to «Nuclear Instruments and Methods A»

*Automatic System Corporation, Smyshlyaevskoe Shosse 1a,
443050 Samara, Russia

1994

1 Introduction

It is evident now that LEP II, providing 2×100 GeV e^+e^- colliding beams will be the last circular e^+e^- collider, so as it seems impossible to overcome problems connected with the synchrotron radiation power losses. It is widely accepted nowadays in the physical community that new generation of electron-positron colliders of TeV energy range should be a linear one.

The most popular approach to construct TeV linear collider assumes to develop standard klystron and accelerating structure technology operating in X-band. These investigations are under study at SLAC (NLC project), KEK (JLC project), Novosibirsk/Protvino (VLEPP project) [1]. There is significant progress in development of accelerating structure technology, the latest results have shown that accelerating gradient about of 100 MV/m is achievable in the X-band accelerating structure [2, 3]. On the other hand, there is rather moderate progress in the development of X-band klystrons, output parameters of experimental devices are significantly less than those required [4].

It should be noted that application of standard klystron technology to the linear collider design possesses several significant disadvantages which are connected with a large scale of the accelerator. It is assumed in all the projects that each klystron feeds one or several accelerating structures of the linear collider. To provide high average accelerating gradient ~ 100 MV/m, the length of accelerating section is usually chosen to be about $l \sim 0.5 - 1$ m, klystron pulse duration $\tau \sim 100$ ns and klystron peak output power $P \sim 100$ MW. For instance, these parameters for the JLC project are equal to $l = 0.7$ m, $\tau = 90$ ns and $P = 120$ MW [1]. So as the half-length of 1 TeV linear collider is about $L \sim 10$ km, the required number of klystrons is of the order of $N \sim 2 - 4 \times 10^4$. Installation of RF pulse compressors will enable one to decrease this number by a factor 2 or 3.

During acceleration cycle of linear collider, $T = L/c \sim 30 \mu\text{s}$, each klystron is switched on only once during time period $\tau \sim 100$ ns and number of simultaneously switched on klystrons is of the order of $c\tau/l$. Thus, the required peak RF power for the electron beam acceleration is about of $Pc\tau/l$ which is by $L/c\tau \sim 300$ times less than total peak RF power of all klystrons. One can obtain that a choice of standard klystron technique is not optimal for design of linear colliders of TeV energy range. First, a huge number of klystrons is needed which may limit a reliability of the linear collider operation. Second, a high-cost RF equipment operates with extremely low duty factor.

In ref. [5] a novel approach to solve the problem of RF power supply for TeV-range linear colliders was proposed which is based on quasi-optical technique. An origin of this idea is as follows. At accelerating gradient about of 100 MV/m half-length of a collider will be of an order of 10 km, while an accelerating RF wavelength will be of

an order of one centimeter. So as characteristic size of the collider is much more than wavelength, thus quasi-optical approach may be used. Another starting point of an idea is of a historical nature. One should remember that designers of powerful radar systems face similar problems as designers of the future generation linear colliders. Namely, they all need a reliable and powerful RF source with short wavelength, high peak RF power and high repetition rate. To solve the radar problems, a unique technique based on the concept of phased array antenna has been developed.

Proposed in ref. [5] RF power supply is based on the use of phased array antenna as a summator and commutator of RF power (see Fig.1).

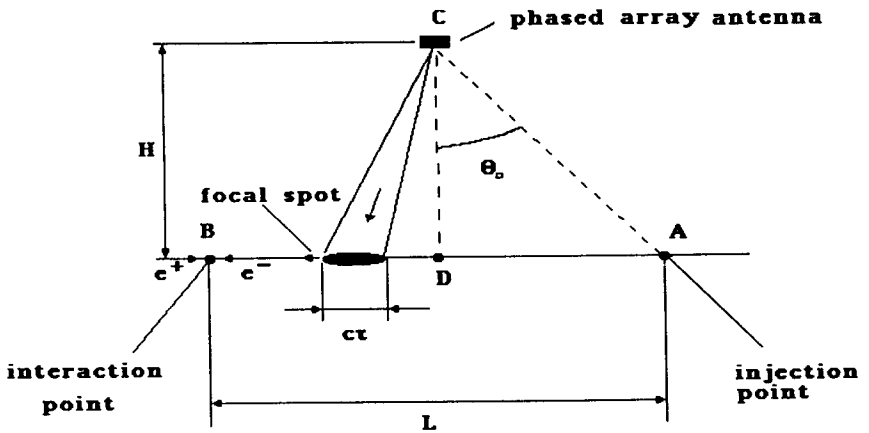

Figure 1: Linear collider scheme based on phased array antenna

The phased array integrates RF power of a large number of low-powerful amplifiers and commutates it with the velocity of light c along the accelerator. The length of accelerating structure commutated to the RF power supply at any moment of time is equal to ct . As a result, at the same number of klystrons, as in the traditional approach, the requirement on the peak power of each klystron is reduced by L/ct times. The use of phased array antenna enables one not only to provide fast commutation of the RF power along the accelerator, but also to provide effective focusing of the RF beam. It takes place when the accelerator with the receiving antenna is placed in Fresnel diffraction zone. In this case the phased array antenna operates as an adaptive microwave lens providing scanning of the focused RF beam along the receiving antenna of the accelerator. The receiving antenna is sectioned into pieces of the length l . Each section of the receiving antenna is commutated

to the accelerating section of the accelerator. So as the longitudinal dimension of the RF beam is equal to $c\tau$, each accelerating section is pumped during the filling time τ whilst the RF beam passes the section of the receiving antenna. When the transmitting phased array antenna is flat, the scanning angle θ_0 should not be greater than 60° which results in the distance H between it and the accelerator to be given by the relation $H \simeq 0.3L$, where L is the half-length of the collider.

The advantages of the proposed scheme are as follows. First, the required peak RF power is diminished by three orders of magnitude. Second, there is no need to develop principally new RF sources, well-developed reliable serial amplifiers may be used. And third, the system is extremely reliable with respect to the breakdown of elements. Even breakage of a large number of elements does not interfere drastically with the operation of the whole system.

We should note that paper [5] contains only the basic idea of the approach. Schemes and examples presented in that paper have had the main goal to illustrate more clear the idea and, of course, are not optimal from technical and economical points of view. Furthermore, we should emphasize that proposed approach does not reject all previous experience stored by powerful research groups during last decade: it entirely agrees with generally accepted solutions of linear collider design: injection system, accelerating structure, final focus, etc. The peculiarity of our approach is in the proposal of a novel concept of RF power supply and a novel method to feed accelerating structure with RF power.

In the present paper we continue to develop the quasi-optical approach to linear collider design aiming the goal to find such physical and technical solutions which will enable one to place RF supply using constraints accepted in linear collider projects. We extend our study with application of such quasi-optical elements as open mirror waveguide, lens waveguide, dielectric waveguide, quasi-optical RF summator and plasma mirror. Two new schemes of RF power supply are proposed. Problems of technical realization are discussed, too.

2 Linear collider scheme on the base of multichannel quasi-optical microwave transmission line

General description

In the present section we propose a novel linear collider scheme which is based on use of multichannel quasi-optical microwave transmission line (see Fig.2). RF source (phased array antenna) is located near the end of the electron (positron) accelerator and the RF power is fed to the accelerator by means of open quasi-optical microwave transmission

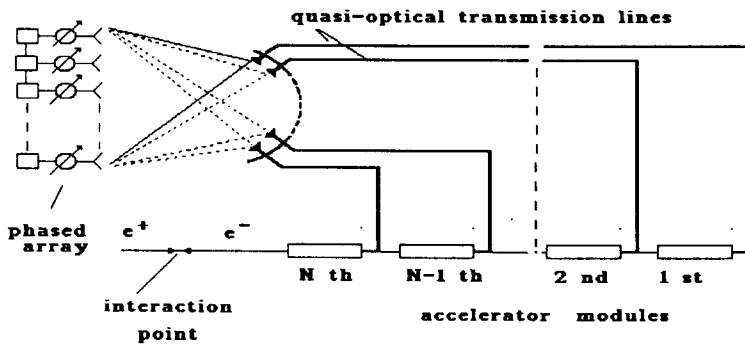

Figure 2: Linear collider scheme based on multichannel microwave transmission line

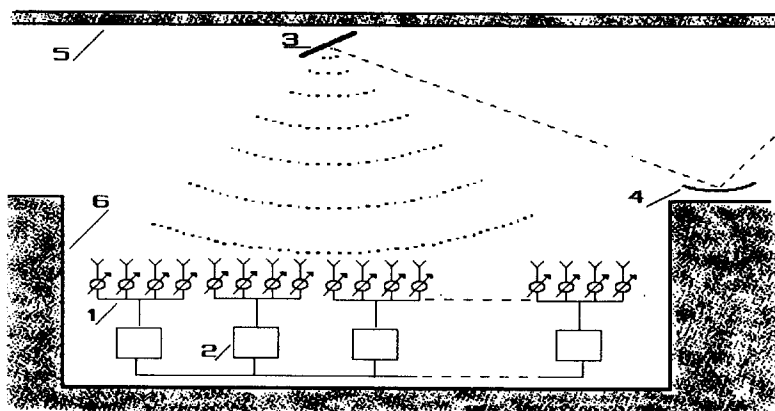

Figure 3: Summator and commutator of RF power on the base of phased array antenna: (1) – phase shifter; (2) – RF amplifier; (3) – redirecting mirror; (4) – entrance of the microwave transmission line; (5) – surface gallery for microwave transmission lines; (6) – shaft for phased array antenna

line. A significant advantage of this scheme is that it has relatively small transverse dimensions and all the equipment (including microwave transmission line) can be placed inside surface and underground premises thus screening the outer environment from harmful influence of RF radiation.

The scheme uses the phased array antenna as a device which integrates and commutates the RF power of a large number of small RF amplifiers into one powerful RF beam (see Fig.3). But contrary to the scheme proposed in ref. [5], the RF power is fed to the accelerating sections in quite another manner. All the accelerator is divided into some number N of identical modules and the RF power is fed to each of them by separate microwave transmission line (see Fig.2). the RF source operates in pulsed mode with pulse duration equal to τ and number of RF pulses per acceleration cycle is equal to the number of accelerating modules N . The time period between RF pulses is equal to $T \simeq (c^{-1} + v_z^{-1})L/N$, where v_z is the group velocity of RF wave along the quasi-optical waveguide axis. For instance, at $N = 50$, T is of the order of $1\mu s$.

The phased array antenna provides commutation of the RF beam between N microwave transmission lines (see Fig.4).

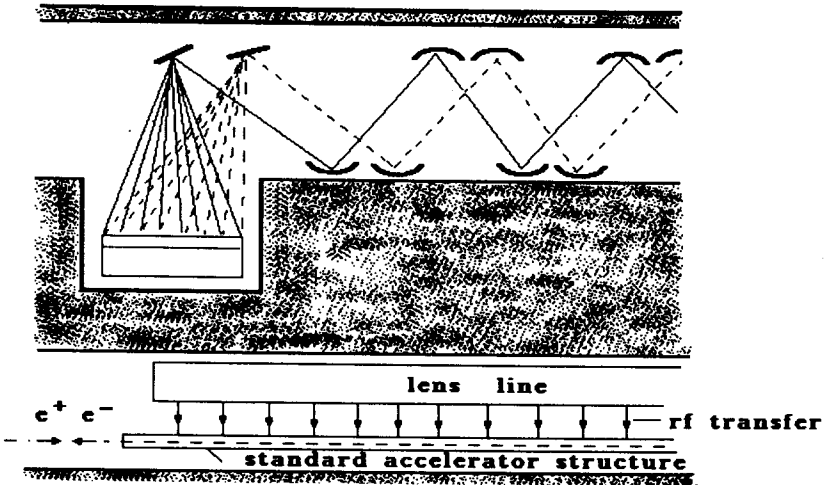

Figure 4: Commutation of RF power to the microwave transmission lines

The acceleration cycle is performed as follows. The first RF pulse is directed by the phased array antenna into the first microwave transmission line which transports the RF power to the first (injection) accelerator module. During the time T between the RF pulses, the RF beam is redirected into the second microwave transmission line, etc.

The accelerator is placed inside an underground tunnel and the RF power is fed to the accelerator modules through N vertical shafts (see Fig.5). To divide the RF power between accelerating sections, the lens waveguide with directional couplers is used.

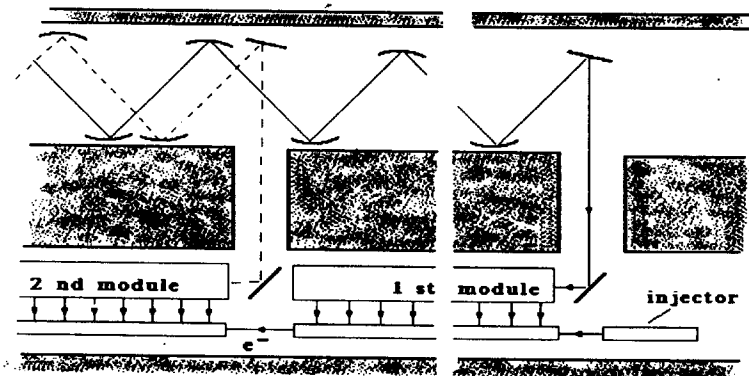

Figure 5: Transfer of RF power from microwave transmission lines to accelerator modules

Let us discuss advantages and disadvantages of the proposed scheme of the linear collider. It is seen that the requirement on the total peak RF power is decreased by a factor of N with respect to the classical scheme using standard klystron technique (not taking into account RF losses in quasi-optical elements). So, at the same number of klystrons, the required peak RF power for each of them is reduced by a factor of N which is of the order of several tens. On the other hand, one should remember that the reducing of the requirements on the peak RF power of X -band klystrons down to the value of several megawatt reveals a possibility to use standard well-developed klystrons, thus solving the problem of RF power supply for linear colliders.

As for the linear collider scheme proposed in ref. [5] (see Fig.1), it is the most optimal with respect to the required peak RF power and the scheme considered above requires by a factor of $L/Nc\tau$ more peak RF power. Nevertheless, it possesses one significant advantage, namely it has relatively small transverse dimensions and all the equipment (including microwave transmission lines) can be placed inside surface and underground premises thus screening the outer environment from harmful influence of RF radiation.

Numerical example

To illustrate the scheme proposed, we consider a conceptual project of 2×0.5 TeV linear collider operating in X -band.

Linear accelerator

Linear collider consists of two linear accelerators: one for electrons and another for positrons. The length of each accelerator is $L = 10$ km. Parameters of the accelerating sections are chosen as follows: RF wavelength $\lambda = 3$ cm, length of accelerating section - $l = 0.7$ m, filling time - $\tau = 0.1\mu\text{s}$. Average accelerating gradient 50 MV/m is achieved at the peak RF power $P = 30$ MW per one accelerating section. The duration of the accelerating cycle is equal to $L/c \simeq 33\mu\text{s}$ and repetition frequency is equal to 300 Hz. It is assumed that each accelerator is divided into $N = 33$ identical modules.

RF power supply

The RF power supply is a phased array antenna which is parallel to the earth surface and is of rectangular form with transverse dimensions 100×100 m². Radiating elements form a rectangular grid with the step $\lambda/2 = 1.5$ cm. $15\,000$ RF amplifiers are commutated to the array. They operate in a pulsed mode and produce 33 pulses of $0.1\mu\text{s}$ duration within the acceleration cycle. The time interval between pulses is equal to $T \simeq 2\mu\text{s}$. Each RF amplifier has peak and average RF power 2 MW and 2 kW, respectively.

Each RF amplifier is joined to a part of antenna with dimensions 80×80 cm² comprising of 2600 radiating elements. Each radiating element is controlled by separate phase shifter which should provide transmission of peak and average RF power 0.5 kW and 0.5 W, respectively, at commutation time $2\mu\text{s}$.

One can obtain that such an RF power supply may be constructed at the present level of the RF technique R&D. For instance, the parameters close to those required are provided by the four cavity klystron X3030 developed by the Varian for space communications. It operates in a CW mode with 1 MW output power at a frequency 8 GHz. Its efficiency is 50% , amplification factor is 35 dB and accelerating voltage - 110 kV. The latter parameter is an extremely important one. Indeed, the use of klystrons with low accelerating voltage together with their compact placement will enable one to simplify significantly a high-voltage system and make all the system to be reliable and effective.

As for phase shifters, the devices with the close parameters are manufactured by microwave industry. For instance, a typical semiconductor phase shifter of X-band provides transmission of 1 kW peak RF power and 10 W average RF power at commutation time $0.1\mu\text{s}$.

Microwave transmission line

The RF power from the RF power supply is transmitted to each of 33 accelerator modules by means of 33 microwave transmission lines. It is assumed that the transmission

lines are periscopic open mirror waveguides (see Appendix B. To provide total RF power losses to be small, the distance between the pairs of mirrors is chosen to be $d = 15$ m. The radius of the mirrors R' should provide the heat RF losses to be greater than the diffraction losses. When mirrors are made of copper, it takes place when $R'^2/\lambda d > 1$, i.e. at $R' \simeq 1$ m. Transverse dimensions of the pair of mirrors of the periscopic mirror waveguide are equal to 2×4 m². As a result, all of the 33 microwave transmission lines may be placed inside the surface gallery with the $4 \text{ m} \times 70 \text{ m}^2$ cross section.

The peak RF power flux on the mirror surface is of the order of 1 MW/cm^2 which corresponds to the strength of the surface electric field about of 18 kV/cm . So, we may conclude that electric durability of this open mirror waveguide is rather large.

Let us calculate the heat RF losses in the microwave transmission line. It is evident that maximal RF losses takes place in the longest waveguide which transmits RF power to the first (injector) accelerator module. The number of reflection in this waveguide is equal to $2L/d \simeq 1200$ and total RF power losses are equal to 40 %. The RF power losses, averaged over all the transmission lines are about 20 % and the heat losses in one mirror are about of 250 W.

RF power divider

The RF power from the RF power supply is transported to the accelerator modules via microwave transmission lines. Then this power should be transported along the accelerator modules and divided among the accelerating sections. To divide the RF power among the accelerating sections, the RF lens line with the RF power dividers is used (see Appendix A and Fig.6). The RF lines are placed along the accelerator in the same underground tunnel and their number is equal to $N = 33$, the number of accelerator modules. The length of each RF lens line is equal to 300 m. RF power is fed to each RF line via corresponding surface microwave transmission line and vertical shaft (see Fig.5).

The RF lens line consists of polystyrene lenses and is placed inside the tube with diameter 1 m filled with SF_6 gas at atmospheric pressure. The distance between lenses in the waveguide is equal to $b = 3$ m, focus distance is equal to $f = 1.5$ m and their maximal thickness is equal to $D_o \simeq 6$ cm. To make diffraction losses to be negligibly small, we choose their diameter to be equal to $2R = 60$ cm. As a result, total RF power losses per one lens are equal to 0.013 dB (including 0.005 dB reflection losses).

At the beginning of the RF lens line the RF heat losses per one lens are about of 2 kW. The heat rejection may be provided by the use of forced liquid cooling. Organosilicic oil may be used as a coolant which has the same values of the refractive index and loss tangent as polystyrene.

The heat losses in the lenses may be reduced significantly when one will use special

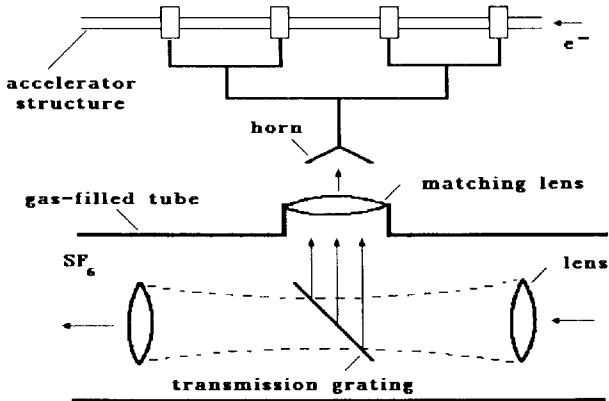

Figure 6: RF power divider

lenses with a shell made of polystyrene and filled with ceresin (mixture of aliphatic hydrocarbons from $C_{39}H_{80}$ up to $C_{53}H_{108}$). The latter material has extremely small loss tangent $\tan \delta \simeq 2 \times 10^{-5}$ and refraction index $n \simeq 1.5$. In this case the heat may be taken aside using forced gas cooling from the lens surface.

Another source of the RF power losses in the RF lens line is the heat losses in the directional couplers which match the RF lens line with the single-mode waveguides of the accelerating sections. We assume the total value of these losses to be about of 5 %.

Electric power consumption

Total RF power losses of the proposed linear collider scheme are composed of losses in the phase shifters of the phased array antenna (10 %), heat losses in the microwave transmission line (20 %), heat and reflection losses in the RF lens lines (15 %) and losses in the directional couplers matching the RF lines with the accelerating sections (5 %). For the total RF power losses we obtain the value about of 50 %.

Total average RF power required for 2×0.5 TeV Linear collider is about of 2×30 MW. Assuming the klystron efficiency to be about of 50 % and efficiency of a high-voltage system to be about of 80 %, we obtain that electric power consumption will be of the order of 150 MW.

Perspectives for future

We have shown above that 2×0.5 TeV linear collider may be constructed at the present level of accelerator and RF technique R&D. One can expect that it is quite possible that in the nearest future the RF industry may master production of X-band klystrons with a peak output power about 8 MW. Installation of these klystron will allow one to double the accelerating gradient and increase the center-of-mass energy of the linear collider up to 2 TeV.

One of the visible disadvantages of the proposed linear collider scheme is a rather bulky system of the microwave transmission lines which should be placed inside a rather large surface gallery. When presenting such a scheme, we have used only well-developed technical solutions which may be used directly in the linear collider design. When considering the further development of the proposal, one should develop novel technical solution to simplify the system of the microwave transmission lines. One of the possible ways to reduce their dimensions is the use of lens waveguides with extremely low losses. It may be realized by the use of artificial dielectric as a material of the lenses (see Appendix C). Another way is to use the step-index dielectric waveguides (see Appendix D). In the both cases the microwave transmission line can be placed in the tube of 1 m diameter and all the RF transporting system can be placed inside several technical tunnels situated near and along the main tunnel of the accelerator.

3 Linear collider scheme on the base of single-channel quasi-optical microwave transmission line and microwave deflectors

General description

In the present section we propose once more linear collider scheme (see Fig.7). The main feature of this scheme is that it uses a single-channel quasi-optical microwave transmission line and microwave deflectors as commutating elements. One of advantages of this scheme is that it has small transverse dimensions which allows one to place all the RF equipment and accelerator in the single tunnel (see Fig.8).

The collider scheme is arranged as follows. As in the scheme, presented in section 2, the accelerator is sectioned into N identical modules. RF power from the RF power supply is transported to the accelerator modules via single microwave transmission line and is commutated to them by microwave deflectors. RF supply operates in a pulsed mode and produces N pulses of duration τ during the accelerator duty cycle. Time interval between pulses is equal to $T \simeq (c^{-1} + v_z^{-1})L/N$, where v_z is the group velocity of the wave along

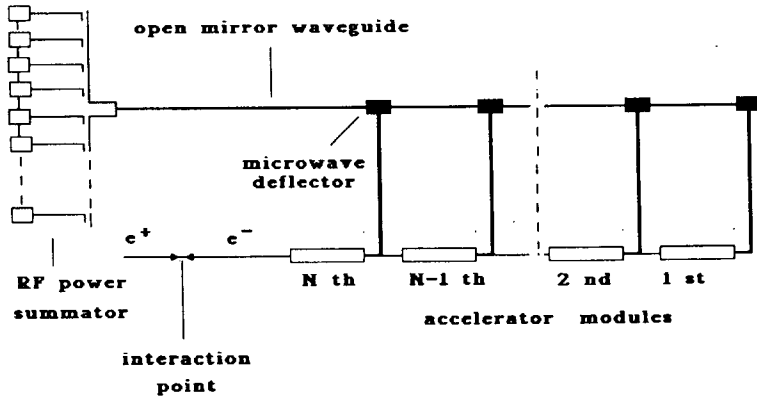

Figure 7: Linear collider scheme based on single-channel microwave transmission line and microwave deflectors

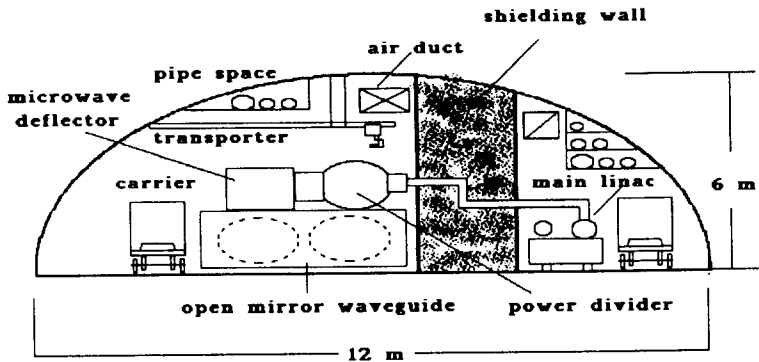

Figure 8: Placement of equipment in the accelerator tunnel

the axis of the microwave transmission line.

The duty cycle of the accelerators proceeds as follows. The first RF pulse is transported via the microwave transmission line to the first (injector) accelerator module. During the time period T between the RF pulses the first microwave deflector is switched on and the second RF pulse is directed to the second module. Prior to arrival of the third RF pulse, the second microwave deflector is switched on and directs it to the third module, etc. Distribution of the RF power among accelerating sections of each module is provided

in the same way as in the scheme, presented in section 2, i.e. by means of the lens transmission line with power dividers. As a result, such a system provides commutation of the RF power along the accelerator with the velocity of light c .

It is seen that the presented linear collider scheme has benefit in the required peak RF power by N times with respect to traditional scheme based on klystron technique.

One of the key elements of the proposed scheme is powerful RF power supply. It is natural to construct such a source on the base of serial low-power amplifiers. Here a problem is arisen, namely that of an optimal choice of an RF summator scheme. We assume to construct RF power source using quasi-optical RF power summator technique which was well developed for needs of radar applications (see Appendix E).

Another key element of the scheme is microwave deflector which should have a capability to commutate a powerful microwave beam. It should be transparent to the microwave radiation when it is switched off. Its rise time should be less than the time period T between RF pulses. And finally, its relaxation time should be less than the time between duty cycles of the accelerator.

In the present paper we propose to use plasma mirror as microwave deflector (see Appendix F and Fig.9).

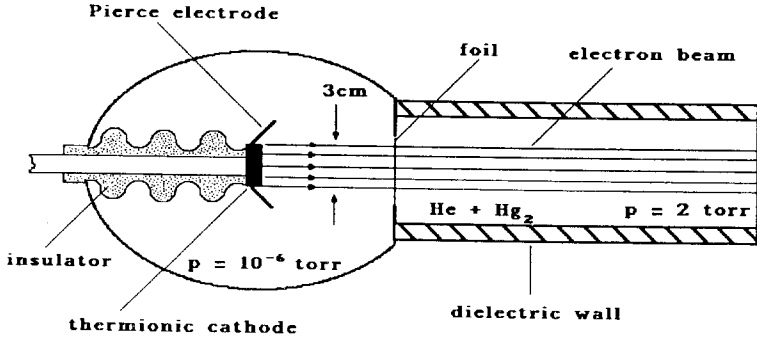

Figure 9: Microwave deflector

The principle of its operation consists in reflection of electromagnetic wave from plasma layer. It may be realized technically in the form of plane gas volume inclined by the angle of 45° with respect to the waveguide axis. We assume to use external electron beam to provide steering the plasma mirror. The rising time of such a device (which is given with the relaxation time of the plasma into the equilibrium state of free electrons) is of the order of several hundreds of nanoseconds. After turning off the external electron beam the electron-ion recombination takes place and the microwave deflector comes to the initial

state after a time period about of several milliseconds.

So as the proposed scheme uses the single-channel microwave transmission line and relatively compact microwave deflectors, all the accelerator and RF equipment may be placed inside the single underground tunnel with transverse dimensions about of 12×6 m² (see Fig.8).

Numerical example

To illustrate the scheme proposed, we consider a conceptual project of 2×0.5 TeV linear collider operating in X-band.

Linear accelerator

All the parameters of the accelerator: RF wavelength ($\lambda = 3$ cm), accelerating sections, total length of the accelerator (2×10 km), repetition rate (300 Hz), number of accelerator modules ($N = 100$), etc, are chosen to be identical to those presented in the numerical example in section 2.

RF power supply

We assume RF power supply to be quasi-optical summator which sums up the power of 15000 RF amplifiers which operate in a pulsed mode providing 100 pulses of $0.1\mu\text{s}$ duration within accelerator duty cycle (see Appendix E. The time period between the accelerator duty cycles is equal to $\simeq 0.6\mu\text{s}$. Each RF amplifier provides 0.7 MW and 2kW of the peak and average output RF power, respectively.

Microwave transmission line

It is assumed that the microwave transmission line is periscopic open mirror waveguide (see Appendix B). To provide total RF power losses to be small, the distance between the pairs of mirrors is chosen to be $d = 15$ m. The radius of the mirrors R' is chosen to be $R' \simeq 1$ m.

The peak RF power flux on the mirror surface is of the order of 0.3 MW/cm² which corresponds to the strength of the surface electric field about of 10 kV/cm. So, we may conclude that electric durability of this open mirror waveguide is rather large.

Let us calculate the heat RF losses in the microwave transmission line. Maximal RF losses occur for the first RF pulse which travels through the full length of the transmission line. The number of reflection in this waveguide is equal to $2L/d \simeq 1200$ and total RF power losses are equal to 40 %. The RF power losses, averaged over all the RF pulses are about 20 %. Maximal heat losses occur in the first mirror and are about of 8 kW.

Microwave deflectors

We suppose to use plasma mirror to provide commutation of powerful RF beam (see Appendix F and Fig.9).

Plasma mirror presents plane chamber filled with gas mixture (He at 2 torr pressure and Hg_2 vapor). Side walls of the gas chamber are made of quartz glass. Plasma mirror is switched on by the sheet electron beam ($E \sim 200$ keV, $I \sim 4.5$ kA) which is produced by pulsed diode mounted in the wall of gas chamber and is injected into the chamber through Ti foil (foil thickness $\sim 10\mu m$). The electron beam cross section inside gas volume is equal to 150×3 cm² ($j_b = 10$ A/cm²) which results in the rate of the free electron production $S \simeq 10^{19}$ cm⁻³s⁻¹, recombination factor $\gamma \simeq 10^{-6}$ cm³/s, relaxation constant $\tau_d \simeq 300$ ns and equilibrium electron density $n_o = (S/\gamma)^{1/2} \simeq 3 \times 10^{12}$ cm⁻³. Such a plasma totally reflects electromagnetic wave with the frequency 10 GHz (penetration depth of radiation into plasma is equal to $d \simeq c/\omega_p \simeq 0.3$ cm).

To estimate RF radiation heat losses in the chamber walls one can use formula (1). When the chamber walls are made of quartz with thickness $D_o \simeq 1$ cm, we obtain the heat RF losses in one plasma mirror to be equal 0.005 dB and the reflection losses - 0.005 dB. Taking into account the number of microwave deflectors to be equal to 100, the averaged RF losses are equal to 0.5 dB.

RF lens line

To divide the RF power among the accelerating sections, the RF lens line with the RF power dividers is used (see Appendix A and Fig.6). The RF lines are placed along the accelerator in the same underground tunnel and their number is equal to $N = 100$, the number of accelerator modules. The length of each RF lens line is equal to 100 m.

The RF lens line consists of polystyrene lenses and is placed inside the tube with diameter 1.2 m filled with the air at atmospheric pressure. The distance between lenses in the waveguide is equal to $b = 3$ m, focus distance is equal to $f = 1.5$ m and their maximal thickness is equal to $D_o \simeq 6$ cm. The lens aperture $2R = 1$ m provides the diffraction losses to be negligibly small. As a result, total RF power losses per one lens are equal to 0.013 dB (including 0.005 dB reflection losses) and average RF losses in the lens RF line are equal to 0.2 dB.

At the beginning of the RF lens line the RF heat losses per one lens are about of 0.7 kW. The heat rejection may be provided by the use of forced liquid cooling.

RF power losses

Total RF power losses of the proposed linear collider scheme are composed of losses in the quasi-optical RF power summator (10 %), heat losses in the microwave transmission line (20 %), heat and reflection losses in the microwave deflectors (15%), heat and reflection losses in the RF lens lines (5 %) and losses in the directional couplers matching the RF lines with the accelerating sections (5 %). For the total RF power losses we obtain the value about of 55 %.

Total average RF power required for 2×0.5 TeV Linear collider is about of 2×30 MW. Assuming the klystron efficiency to be about of 50 % and efficiency of a high-voltage system to be about of 80 %, we obtain that electric power consumption will be of the order of 150 MW.

Perspectives

Replacement of 0.7 MW klystrons with 3 MW klystrons will allow one to double the accelerating gradient and increase the center-of-mass energy of the linear collider up to 2 TeV.

4 Conclusion

In this paper we have presented two novel linear collider schemes based on application of quasi-optical approach for constructing RF power supply for TeV linear colliders. We realize that it is too early to fix a choice at any concrete conceptual project due to variety of the possibilities and investigations in this direction should be prolonged. Nevertheless, the examples presented shows that quasi-optical approach forms a firm base for constructing linear collider of TeV energy range at the present-day level of accelerator and RF technique R&D.

Appendixes

A Use of lens waveguide with directional couplers as RF power divider

The main essence of the proposed linear collider schemes consists in use of single RF power source commutated to finite number N of the accelerator modules. Then RF power should be transported along the accelerator module and divided among the accelerating sections. The length of the RF power divider is equal to the length of the accelerator

module L/N and is of an order of several hundreds meters (L is the total length of the accelerator).

We propose to use a lens waveguide with directional couplers as RF power divider (see Figs.6 and 10).

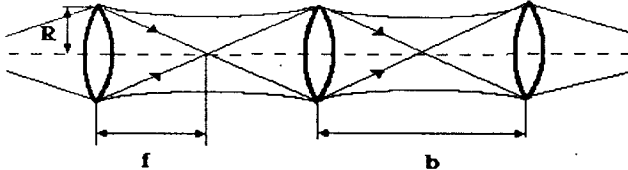

Figure 10: Lens waveguide

It is composed of identical, even spaced long-focus lens. Below we consider the case of confocal lens waveguide ($b = 2f$, where b is the distance between lenses and f is their focus distance). Such a waveguide provides stable transportation of the TEM-mode RF beam.

Diffraction losses of the confocal lens waveguide are defined by Fresnel number $N_F = R^2/\lambda_r f b$ and are negligibly small at $N_F > 1$. So as lens waveguide is placed in the accelerator tunnel, it is reasonable to set its diameter $2R$ to be not greater than 1 m. As a result, the distance between lenses b should be about of several meters and total number of lenses in each module should be of the order of 100.

Simple estimations show that RF power which should be transmitted via waveguide exceeds significantly the breakdown threshold for dry air at atmospheric pressure, so all the waveguide should be placed inside the closed volume (metallic pipe coated inside with a microwave absorber) filled, for instance, with SF_6 gas at high pressure.

To divide RF power among accelerating sections, directional couplers should be installed along the waveguide. There exist many possible configurations of such a couplers. The simplest one presents a wire grid or dielectric plate inclined by the angle 45° with respect to the RF beam propagation direction. The fraction of the taken off energy is defined by the values of transmission and reflection coefficients. The reflection coefficient of the wire grid depends on the ratio of the wire step to the RF wavelength and on the polarization of the wave (the latter is proportional to $\cos \varphi$, where φ is the angle between the electric field vector \vec{E} and wires).

We assume to place the directional couplers in each waveguide period as shown in Fig.6. Each coupler consists of wire grid and matching dielectric lens and feeds several accelerating sections via single-mode waveguides. The latter ones have time delay

providing synchronization of adjacent accelerating sections.

The total RF power losses of the proposed RF power divider are composed of diffraction losses, reflection losses from the lenses and heat losses in the lenses. We have shown above that diffraction losses can be made negligibly small at a proper choice of lens diameter and distance between them.

Let us consider now the problem of reflection losses. In the general case the lens boundary reflects some part of the wave due to the difference in refractive indexes of the material of the lens and of the medium between lenses. This effect may be diminished significantly by application of antireflection film technique (i.e. by coating the lens with $\lambda/4$ dielectric layer). When RF radiation is linearly polarized, undesired reflection may be diminished also by inclination of lenses at Brewster's angle with respect to the waveguide axis. In this case lenses should be shaped in such a form to provide the ray path in the inclined lens to be the same as in ordinary lens.

It should be noted that the problem to decrease reflection losses of RF radiation has been studied thoroughly for needs of radar applications and significant progress was achieved in this field [6]. As a result, the present level of RF technique R&D allows one to manufacture lenses with reflection losses 0.005 dB per one lens.

Heat losses in the lens are defined by the value of loss tangent $\tan \delta$ of dielectric and its thickness. When confocal waveguide operates at ground mode, the value of heat losses in the single lens is given with the expression:

$$\alpha(\text{dB}) \simeq 4.3k'D_o \tan \delta, \quad (1)$$

where $k' = 2\pi n/\lambda_{rf}$, n is refraction index, D_o is maximal thickness of the lens:

$$D_o = [f^2/(n + 1)^2 + R^2/(n^2 - 1)]^2 - f/(n + 1),$$

where f is focus distance of the lens.

As a rule, dielectric lenses are manufactured using low loss HF dielectrics with refraction index slightly greater than unity. For instance, the most popular material for radar lens antennas, polystyrene, has refractive index $n \simeq 1.6$ for X-band radiation and loss tangent $\tan \delta \simeq 2 \times 10^{-4}$.

For the numerical examples presented in this paper, maximal thickness of polystyrene lenses should be about of 5 cm. As a result, total heat losses in the 100 lenses waveguide are about of 1 dB.

In conclusion let us discuss some problems to be taken into account when using such an RF power divider for pumping accelerating structure of linear collider. First, the group velocity $v_g = d\omega/dk_z$ of the wave in the lens waveguide is always less than the velocity of

light c . So, one should take into account the slippage of the RF wave packet with respect to accelerating electron beam. This effect can be neglected when

$$c\tau/(c - v_g) \gg L/cN.$$

Remembering that $k_z^2 + k_\perp^2 = \omega^2/c^2$ and expression for the transverse wavenumber of the ground mode of the lens waveguide is given with the expression $k_\perp \simeq 2^{1/2}/R$, we obtain the following restrictions on the parameters:

$$36c\tau R^2/\lambda_{rf}^2 \gg 2L/N,$$

where τ is filling time of accelerating section.

Another factor to be taken into account is the spatial dispersion of the RF wave packet during its propagation in the waveguide. A characteristic time interval ΔT of spatial dispersion can be found from the relation

$$\Delta T(\Delta k_z)^2 \partial^2 \omega / \partial k_z^2 \simeq 2\pi.$$

The effect of spatial RF wave packet dispersion is negligible when $\Delta T \gg 2L/cN$. Using relation $\Delta k_z c\tau \simeq 2\pi$, the latter condition may be written in the form:

$$2\pi^2(c\tau)^2 R^2/\lambda_{rf}^3 \gg 2L/N.$$

Simple estimations show that for numerical examples, presented in this paper, this effect is negligibly small.

B Use of microwave open mirror waveguide as microwave transmission line

One of the key elements of a novel configuration of the RF power supply for TeV energy range linear collider is microwave transmission line (see sections 2 and 3). It should provide transmission of powerful RF beam along a linear accelerator without significant power losses. Analysis of the present day level of RF technique R&D shows that the most suitable way to construct such a transmission line is to use an air open mirror waveguide which possesses the required features, namely by simplicity of technical realization and low power losses.

In the present paper we confine our consideration with the case of the X-band RF wavelength range, namely $\lambda_{rf} \sim 3$ cm. The air is almost transparent for the waves with such a wavelength (the attenuation is of the order of 0.1 dB at the distance of 10 km). To avoid the attenuation of RF beam due to the influence of precipitation and dust, the

microwave transmission line should be placed inside a building. As a result, the total RF power losses of the open mirror waveguide are composed of diffraction losses and heat losses in the mirrors.

A simplest scheme of the open mirror waveguide is presented in Fig.11.

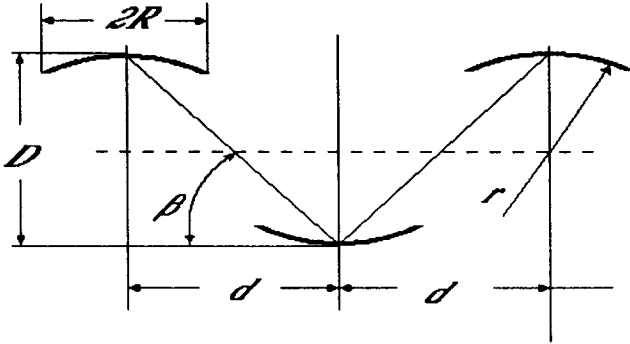

Figure 11: The simplest scheme of the open mirror waveguide

It is assumed to be composed of periodical sequence of identical spherical mirrors. When the angle of incidence of the central RF ray to the mirror does not exceed 60° , the eigenmodes of the open mirror waveguide are rather insensitive to the mirror misalignment and imperfections. For instance, there is no significant deterioration of the waveguide properties in the case of concave mirrors, so we assume the concave mirror waveguide to be the most appropriate for practical application providing minimal transverse dimensions.

The RF beam propagating in such a waveguide is bounded in the transverse direction by caustic surface and its intensity is dropped exponentially outside the caustic surface. As a result, at a proper choice of the open mirror waveguide parameters, the diffraction losses can be made negligibly small. To find diffraction losses in the open mirror waveguide we, following by ref. [7], use an analogy of the open mirror waveguide with an open resonator (see Fig.12) with the well known properties. These systems are equivalent when the following conditions are fulfilled:

$$r' = r \sin \beta, \quad R' = R \sin \beta, \quad d' = (d^2 + D^2)^{1/2},$$

where β is the angle of incidence, r and $2R$ are the radius of curvature and aperture of the waveguide mirror, respectively. The corresponding notations r' and $2R'$ refer to the

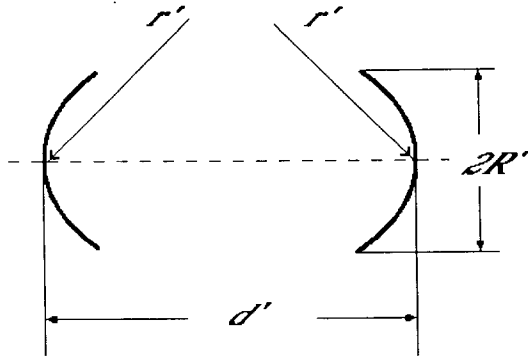

Figure 12: Open resonator with the same diffraction losses as the open mirror waveguide presented in Fig.11

equivalent resonator parameters. Diffraction losses of the concave mirror waveguide are defined by the only parameter, namely by Fresnel number $N'_F = R'^2/\lambda_{rf}d$ and at $N'_F > 1$ become to be less than 10^{-4} .

When RF wavelength $\lambda_{rf} \gtrsim 10^{-2}$ cm, the reflection factor of the electromagnetic wave from metallic mirror is given with:

$$\Gamma = 1 - 2(c/\lambda_{rf}\sigma)^{1/2},$$

where σ is the conductivity of the mirror material. For instance, at $\lambda_{rf} \simeq 3$ cm, normal incidence of the wave and cooper mirror, the RF power losses in the mirror are equal to 3×10^{-4} . Thus, in the X-band RF wavelength range, when Fresnel number N'_F is greater than unity, the total power losses in the concave mirror waveguide are defined totally by the heat losses.

Now we can estimate the number of mirrors of the open mirror waveguide for the conceptual projects of TeV linear collider. We assume the mirrors to be made of cooper. Maximal length of the waveguide is equal to $L \simeq 10$ km. To provide the heat losses in the mirrors to be at a reasonable level, the total number of reflections should not be greater than 1000 which results in the axial distance d between mirrors to be greater than 10 m.

We have considered above the most simplest waveguide configuration (see Fig.11). One can obtain that such a configuration possesses a significant disadvantage. Namely, its transverse dimension D can not be made much less than the axial distance d between the mirrors because the angle of incidence should be less than 60° . As a result, such a

transmission line for TeV range linear collider should have transverse dimension $D \sim 10$ m.

To diminish transverse waveguide dimensions, a periscopic mirror waveguide may be used (see Fig.13).

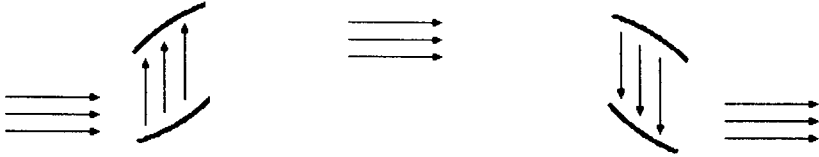

Figure 13: Periscopic mirror waveguide

The angle of incidence in this scheme is equal to 45° and minimal transverse dimensions of the microwave transmission line are equal to $2^{3/2}R \times 2R$, where R is the curvature radius of the mirrors.

When constructing the open mirror waveguide one should remember that the problem of the RF discharge in the air may take place. Experimental results indicate that in the X-band RF wavelength range, the RF discharge threshold is about 30 kV/cm in a dry air at atmospheric pressure. A more detailed study has shown that this effect does not play an important role when choosing the parameters of the open mirror waveguide as the microwave transmission line for linear colliders.

C Use of the metallo-dielectric lens waveguide as microwave transmission line

Significant reducing of the heat losses in the RF lens line may be achieved by metallo-dielectric lenses (see, e.g. ref. [6]). An artificial dielectric is used as a material for these lenses which presents a set of metallic particles imitating crystallic structure of dielectric. To made such a construction to be rigid, metallic particles are pressed into an insulator with the refraction index close to the unity. The most popular insulator is cellular polystyrene which has $\epsilon \simeq 1.02$ and specific weight 0.03 g/cm^3 (specific weight of polystyrene is 1 g/cm^3). The size of particles and the distances between them should be much less than the RF wavelength λ .

The refraction index of artificial dielectric n is greater than unity as well as that of natural. For example, when metallic particles present the form of a disk, it may be calculated with the formula:

$$n = [1 + 16\rho r_o^3/3]^{1/2},$$

where ρ is the number of particles in the unit volume, r_o is the radius of the disk. As a rule, the refraction index of artificial dielectric is usually chosen to be $n = 1.5 - 1.6$. So as cellular polystyrene may have extremely low the loss tangent, it reveals a possibility to construct metallo-dielectric lens with the heat losses which are by two orders of magnitude less than that of polystyrene one. In addition, the reflection losses may be reduced significantly by using the technique of a smooth decrease of the refractive index towards the lens surface.

D Use of step-index dielectric waveguide as microwave transmission line

One of the possible ways to construct microwave transmission line is application of a dielectric waveguide technique [8, 9]. The simplest example of dielectric waveguide is dielectric cylinder with the refractive index n_1 surrounded with another concentric dielectric cylinder with the refractive index n_2 . When $n_1 > n_2$, the electromagnetic field propagates mainly inside the inner cylinder and decays exponentially inside the outer one. As a rule, there is no need to choose dielectrics with essentially different refractive indexes to provide effective radiation guiding. It takes place when $n_1 - n_2 \ll n_1$ and usually does not exceed the value of 1 %. It should be noted that absolute value of the refractive index does not play any role in the guiding effect and the value of n_2 can be chosen, for instance, to be close to the unity.

The RF line on the base of dielectric waveguide possesses several advantages against the RF lens lines. First, it may have small transverse dimensions. Second, there is no problem of reflection losses. Third, the heat losses may be reduced significantly by the use gases as dielectrics. The latter waveguide may be designed in the following way. The outer shell of the waveguide is metallic tube. The inner volume is divided into two parts by a thin and firm shell with a small loss tangent. Each part of the volume is filled by different gases at the same pressure (which may be rather high). The inner and outer volumes may be filled, for instance by CO_2 and N_2 , respectively, at 10 bar pressure. The jump in the refractive index at the volume boundary is equal to $(n_1 - n_2)/n_1 \simeq 0.5$ %.

E Quasi-optical RF power summator

The linear collider concept proposed in section 3 uses single powerful RF power source. It is natural to construct such a source on the base of serial low-power amplifiers. Here

a problem is arisen, namely that of an optimal choice of an RF summator scheme. We assume to construct RF power source using quasi-optical RF power summator technique which was well developed for needs of radar applications [6]. A simplest scheme of quasi-optical summator is presented in Fig.14.

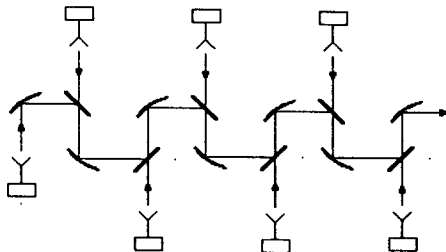

Figure 14: The simplest scheme of quasi-optical RF power summator

The main element of quasi-optical RF power summator is quasi-optical directive coupler which has the form of wire grating placed at the angle of 45° with respect to the quasi-optical waveguide axis (see Fig.15).

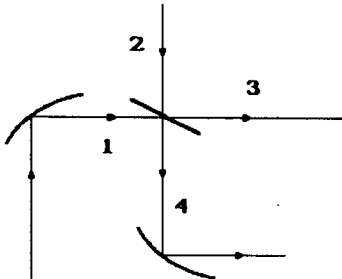

Figure 15: Summation of RF power in the quasi-optical RF power summator

Matching of the summator scheme is performed by a proper choice of the transmitting factor K of the wire grating. Complex amplitudes a_1 and a_2 of input waves are connected with complex amplitudes b_3 and b_4 by the following relation:

$$b_3 = K a_1 - i(1 - K^2)^{1/2} a_2, \quad b_4 = -i(1 - K^2)^{1/2} a_1 + K a_2.$$

When $K = [1 + |a_1|^2/|a_2|^2]^{-1/2}$ and phase difference at entries 1 and 2 is equal to $\varphi_1 - \varphi_2 = \pi/2$, complex amplitude b_3 becomes equal to zero and all the RF power is directed into the waveguide.

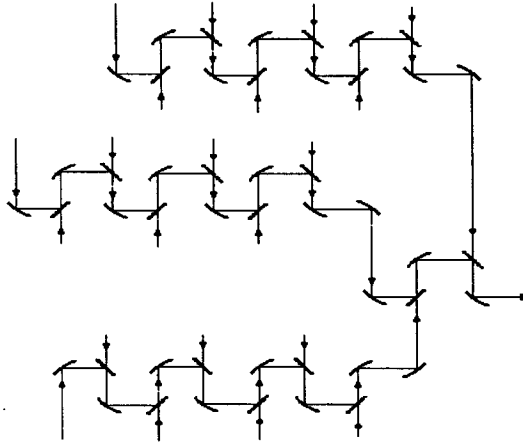

Figure 16: Multi-branch scheme of quasi-optical RF power summator

In conclusion we should note that in practical situation, to make an arrangement of the RF source to be more compact, the RF summator scheme may be designed using tree-like structure (see Fig.16).

F Use of plasma mirror as commutator of RF power

To provide commutation of powerful RF beam, plasma mirror can be used. Principle of its action consists in reflection of RF wave from ionized gas layer. Physically plasma mirror presents plane chamber filled with gas mixture. The volume is composed with two parallel plates. When there is no plasma in the volume, this device is transparent for RF radiation. Plasma mirror is switched on by external electron beam with energy about of several hundreds keV which produces plasma and is switched off when the electron beam is turned off. After recombination period (several hundreds of microseconds) it relaxes into initial state. So, the use of external electron beam gives a possibility to control the plasma mirror operation.

Let us perform a more detailed study of plasma mirror.

The plasma mirror chamber is filled with gas mixture (*He* at 2 torr pressure and *Hg₂* vapor). Threshold of RF breakdown of this mixture is rather large, about 20 kV/cm at RF frequency 10 GHz (see, e.g. ref. [10]).

Sheet electron beam ($E \sim 200$ keV, $I \sim 4.5$ kA) is produced by pulsed diode mounted

in the wall of gas chamber (see Fig.9) and is injected into the chamber through Ti foil (foil thickness $\sim 10\mu\text{m}$).

The rate of secondary electron production in unit volume is given with the expression:

$$S = j_b \rho (dE/dx) / c W_{ion}, \quad (2)$$

where j_b is current density of electron beam, $\rho \simeq 5 \times 10^{-7} \text{ g/cm}^3$ is gas density at 2 torr pressure, dE/dx is ionizing losses ($dE/dx \simeq 5 \times 10^6 \text{ eV cm}^2/\text{g}$ for He) and W_{ion} is mean energy required to produce electron-ion pair ($W_{ion} \sim 20 \text{ eV}$). The ionization process is proceeds as follows. Ionizing cross-section of Hg_2 by metastable He (2^3S) atoms (excitation energy $E^* = 19.8 \text{ eV}$), is anomalously large, so each events of the He atom excitation leads to the appearance of electron. As a result, the ionization rate of the gas mixture is almost the same as the rate of the He atoms excitation.

A change in time of free electron density is subjected to the equation:

$$dn/dt = S - \gamma n^2. \quad (3)$$

The second term in the right-hand side of equation (3) describes recombination process and γ is recombination factor. So as plasma is assumed to be quasi-neutral (electron and ion density are equal), this term is proportional to n^2 .

Solution of equation (3) may be written in the form:

$$n = (S/\gamma)^{1/2} \text{th} [(S/\gamma)^{1/2} t]. \quad (4)$$

So, the relaxation constant τ_d is equal to:

$$\tau_d = (S/\gamma)^{-1/2}. \quad (5)$$

In the system under study electron beam cross section inside gas volume is equal to $150 \times 3 \text{ cm}^2$ ($j_b = 10 \text{ A/cm}^2$) which results in the rate of the free electron production $S \simeq 10^{19} \text{ cm}^{-3}\text{s}^{-1}$, recombination factor $\gamma \simeq 10^{-6} \text{ cm}^3/\text{s}$, relaxation constant $\tau_d \simeq 300 \text{ ns}$ and equilibrium electron density $n_o = (S/\gamma)^{1/2} \simeq 3 \times 10^{12} \text{ cm}^{-3}$.

Now let us consider the process of interaction of electromagnetic wave with the plasma. Electric field, oscillating with the frequency ω , induces the following current density in the plasma:

$$\vec{j} = \sigma \vec{E} + (4\pi)^{-1}(\epsilon - 1)\partial \vec{E}/\partial t, \quad \vec{E} = \vec{E}_o \sin(\omega t).$$

Conductivity σ and permittivity ϵ of plasma are given with the expressions:

$$\sigma = e^2 n_o \nu_m / m(\omega^2 + \nu_m^2), \quad \epsilon = 1 - 4\pi e^2 n_o / m(\omega^2 + \nu_m^2),$$

where e and m are charge and mass of electron, respectively, and ν_m is collision rate.

Our numerical example refers to the case of a slightly ionized plasma when electrons collide only with atoms and the collision rate is equal to $\nu_m \simeq 6 \times 10^9 \text{ s}^{-1}$. On the other hand, the frequency of the electromagnetic wave is equal to $\omega \simeq 6 \times 10^{10} \text{ s}^{-1}$. Thus, the value of ω^2 exceeds by two orders of magnitude the value of ν_m^2 and plasma in the plasma mirror may be considered as collisionless. Expression for the plasma permittivity ϵ may be written in the form:

$$\epsilon = 1 - \omega_p^2/\omega^2, \omega_p = (4\pi e^2 n_o/m)^{1/2} = 5.7 \times 10^4 n_o^{1/2} \text{ s}^{-1}.$$

It takes zero value and becomes negative at the electromagnetic wave frequency $\omega < \omega_p$. In our numerical example plasma frequency $\omega_p \simeq 10^{11} \text{ s}^{-1}$, so the electromagnetic wave with the frequency 10 GHz can not propagate in plasma and is totally reflected. Its penetration depth into plasma is equal to $d \simeq c/\omega_p \simeq 0.3 \text{ cm}$.

In conclusion let us discuss the problems of technical realization of the proposed plasma mirror.

Side walls of the gas chamber may be manufactured using quartz glass. This material possesses mechanical durability, it is stable to harmful radiation influence. Its permittivity and loss tangent are rather small at the frequency 10 GHz, $\epsilon \simeq 4$ and $\tan \delta \simeq 10^{-4}$. Special kind of ceramics may be used, too. Significant experience in this field has been stored during development of radars for airplanes (see, e.g. ref. [6]).

To estimate RF radiation losses in the chamber walls one can use formula (1). Assuming the walls to be made of quartz with thickness $D_o \simeq 1 \text{ cm}$, we obtain the heat RF losses in one plasma mirror to be equal 0.005 dB and the reflection losses - 0.005 dB. To avoid undesirable reflections from the chamber walls, the antireflection film technique (i.e. by coating the walls with $\lambda/4$ dielectric layer) may be used, too.

References

- [1] Status Reports of NLC, JLC and VLEPP are given in: "Proceedings of the LC'92 ECFA Workshop on e^+e^- Linear Colliders (July, 25 – August , 2, 1993, Germany)", MPI-PhE/93-14, ECFA 93-154
- [2] M.A. Allen et al., Phys. Rev. Lett. **63**(1989)2472
- [3] T. Higo et al., "High Gradient Testing of an 11.4 GHz Accelerating Structure for KEK/CERN Linear Collider Studies", CLIC Note 187, CERN, 1993.
- [4] Theodore L. Lavine, "Review of Pulsed Power Generation", Invited talk at the 3rd European Particle Accelerator Conference, Berlin, Germany, 1992. Available as SLAC-PUB-5806, April, 1992
- [5] E.L. Saldin, E.A. Schneidmiller and M.V.Yurkov, "A Novel Concept of a RF Power Supply for TeV Linear Colliders", Preprint JINR E9-93-134, Dubna, 1993, Nucl. Instrum. and Methods, in press
- [6] M.I. Skolnik. Radar Handbook. McGraw-Hill Book Company, 1970.
- [7] L.A. Veinstein, Open Resonators and Waveguides. Sovetskoe Radio, Moscow, 1966
- [8] D. Marcuse, Light transmission optics. Van Nostrand Reinhold, New York, 1972
- [9] M.J. Adams, An introduction to optical waveguides. Wiley, New York, 1981
- [10] Yu.P. Rizer, Contemporay physics of gas discharge. Nauka, Moscow, 1980, in Russian

Received by Publishing Department
on May 11, 1994.

SUBJECT CATEGORIES OF THE JINR PUBLICATIONS

Index	Subject
1.	High energy experimental physics
2.	High energy theoretical physics
3.	Low energy experimental physics
4.	Low energy theoretical physics
5.	Mathematics
6.	Nuclear spectroscopy and radiochemistry
7.	Heavy ion physics
8.	Cryogenics
9.	Accelerators
10.	Automatization of data processing
11.	Computing mathematics and technique
12.	Chemistry
13.	Experimental techniques and methods
14.	Solid state physics. Liquids
15.	Experimental physics of nuclear reactions at low energies
16.	Health physics. Shieldings
17.	Theory of condensed matter
18.	Applied researches
19.	Biophysics

E9-94-94

Салдин Е.Л. и др.

Применение квазиоптического подхода к созданию системы СВЧ-питания линейных коллайдеров ТэВ-диапазона энергий

Предложен принципиально новый подход к построению системы СВЧ-питания линейных коллайдеров ТэВ-диапазона энергий, основанный на использовании квазиоптических элементов для суммирования и коммутации мощностей большого числа СВЧ-источников. Предложенные схемы позволяют уменьшить требуемую импульсную СВЧ-мощность, например для X-диапазона, в несколько десятков раз. Приведен численный пример для линейного коллайдера на энергию 2x0,5 ТэВ. Показано, что применение квазиоптического подхода позволит создать систему СВЧ-питания такого коллайдера на базе выпускаемых серийно клистронов с пиковой мощностью 0,7 МВт. Все оборудование ускорителя может быть размещено в одном стандартном туннеле с поперечными размерами 12x6 м .

Работа выполнена в Лаборатории сверхвысоких энергий ОИЯИ.

Препринт Объединенного института ядерных исследований. Дубна, 1994

E9-94-94

Saldin E.L. et al.

Application of Quasi-Optical Approach to Construct RF power Supply for TeV Linear Colliders

An idea to use quasi-optical approach for constructing RF power supply for TeV linear e^+e^- colliders is developed. RF source of the proposed scheme is composed of a large number of low-powerful RF amplifiers commutated by quasi-optical elements. RF power of this source is transmitted to the accelerating structure of the collider by means of quasi-optical waveguides and mirrors. Such an approach enables one not only to decrease the required peak RF power by several orders of magnitude with respect to the traditional approach based on standard klystron technique, but also to achieve the required level of reliability, so as it is based on well-developed technology of serial microwave devices. To illustrate the proposed scheme, a conceptual project of 2x500 GeV X-band collider is considered. Accelerating structure of the collider is standard travelling wave one and RF source is assumed to be composed of 0.7 MW klystrons. All equipment of such a collider is placed in a tunnel of 12x6 m cross section. It is shown that such a collider may be constructed at the present level of accelerator technique R&D.

The investigation has been performed at the Laboratory of Particle Physics, JINR.

Preprint of the Joint Institute for Nuclear Research. Dubna, 1994

Макет Т.Е.Попеко

Подписано в печать 24.05.94

Формат 60×90/16. Офсетная печать. Уч.-изд.листов 2,27

Тираж 295. Заказ 47244. Цена 410 р.

Издательский отдел Объединенного института ядерных исследований
Дубна Московской области