

PREPARED FOR SUBMISSION TO JHEP

Ring Relations and Mirror Map from Branes

Benjamin Assel

CERN, Theoretical Physics Department, CH-1211 Geneva 23, Switzerland

E-mail: benjamin.assel@gmail.com

ABSTRACT: We study the space of vacua of three-dimensional $\mathcal{N} = 4$ theories from a novel approach building on the type IIB brane realization of the theory and in which the insertion of local chiral operators in the path integral is obtained from integrating out light modes in appropriate brane setups. Most of our analysis focuses on abelian quiver theories which can be realized as the low-energy theory of D3-D5-NS5 brane arrays. Their space of vacua contains a Higgs branch, parametrized by the vevs of half-BPS meson operators, and a Coulomb branch, parametrized by the vevs of half-BPS monopole operators. We show that the Higgs operators are inserted by adding F1 strings and D3 branes, while Coulomb operators are inserted by adding D1 strings and D3 branes, with specific orientations, to the initial brane setup of the theory. This approach has two main advantages. First the ring relations describing the Higgs and Coulomb branches can be derived by looking at specific brane setups with multiple interpretations in terms of operator insertions. This provides a new derivation of the Coulomb branch quantum relations. Secondly the map between the Higgs and Coulomb operators of mirror dual theories can be derived in a trivial way from IIB S-duality.

Contents

1	Introduction and Discussion	2
2	Light review on $\mathcal{N} = 4$ theories and their moduli space of vacua	6
3	The brane realization of half-BPS local operator insertions	9
3.1	Branes and strings inserting half-BPS local operators	10
4	Analysis in the $T[SU(2)]$ theory	14
4.1	Higgs branch operators	14
4.2	Coulomb branch operators	19
4.3	Ring relations	21
4.4	Mirror symmetry	26
4.5	Deformations	28
5	Abelian generalizations	32
5.1	SQED	32
5.1.1	Higgs branch	33
5.1.2	Coulomb branch	38
5.2	Abelian Quiver	40
5.2.1	Higgs branch	40
5.2.2	Coulomb branch	46
5.3	Mirror Symmetry	50
5.4	Another example	52
6	Other chiral operators	59
7	Non-abelian theories	62
A	SQED Higgs branch relations	68
B	Brane setup - Operator insertion dictionary	69
B.1	Higgs branch operators	70
B.2	Coulomb branch operators	71
B.3	Mirror Map	74

1 Introduction and Discussion

Three-dimensional $\mathcal{N} = 4$ Yang-Mills gauge theories (i.e. with eight Poincaré supercharges) are fully characterized by a choice of gauge group G , associated to a vector multiplet, and a pseudo-real representation \mathcal{R} in which the hyper-multiplet matter fields transform. This data fixes uniquely the Lagrangian of the theory. Their space of vacua splits into several subspaces or “branches”, each of which is a product of hyper-Kähler manifolds, with two branches playing a special role. The Higgs branch, which is free of quantum corrections [1], is parametrized by the vacuum expectation values (vevs) of the scalars in the hyper-multiplet, subject to a triplet of D-term constraints, and modulo gauge transformations. In a chosen complex structure the Higgs branch can be described as a complex algebraic variety, with singularities, parametrized by the vevs of gauge invariant operators, which are chiral with respect to a certain $\mathcal{N} = 2$ subalgebra, subject to algebraic relations (inherited from the chiral ring relations). The Coulomb branch is parametrized by the vevs of half-BPS monopole operators which are chiral with respect to another $\mathcal{N} = 2$ subalgebra, and which form a ring with relations arising from non-trivial quantum effects [2, 3]. The monopole operators are defined in the quantum theory by imposing in the path integral formulation a Dirac monopole singularity for the gauge field at a point in Euclidean space and “dressing” it with a polynomial in the vector multiplet complex scalars. A special case are monopoles with zero magnetic charges which are simply gauge invariant combinations of the vector multiplet complex scalars.¹

While there is a relatively clear path to study the Higgs branch from the classical Lagrangian of the theory, the Coulomb branch is more difficult to access, since the ring relations between monopole operators do not follow from a superpotential, but from the quantum dynamics of the theory. In abelian theories the Coulomb branch metric receives corrections only at one-loop and can be computed directly [4, 5]. It is also possible to rely on mirror symmetry [1], which exchanges the Higgs and Coulomb branches of mirror dual theories. Much progress has been made recently on deriving the ring relations of the Coulomb branch of quiver gauge theories from different approaches. One approach uses the Coulomb branch Hilbert series [6–10]², which is a protected index counting chiral monopole operators refined with fugacities keeping track of their charges under Cartan R-symmetry and global topological symmetries. From the resummed series one is able to extract a set of generators and to read the Coulomb branch relations, up to coefficients which must be determined by other methods. Non-abelian

¹In addition there can be mixed branches which will not be studied in this paper, to keep the presentation simple.

²See [11] for a recent review on 3d (and 4d) Hilbert series.

quiver theories of ADE types with unitary or ortho-symplectic gauge nodes have been studied using this method. A different construction was proposed by Bullimore, Dimofte and Gaiotto in [12] to derive the Coulomb branch relations of non-abelian quiver theories. The construction is based on the embedding on the non-abelian CB (Coulomb branch) chiral ring into the CB chiral ring of the low-energy abelian theory which exists at generic points on the Coulomb branch. Each monopole operator of the non-abelian theory is mapped to a gauge invariant polynomial of abelian monopole operators and the non-abelian relations can be extracted from “abelianized” relations involving the operators of the abelian theory. A mathematical approach to 3d $\mathcal{N} = 4$ Coulomb branches was also proposed in [13–15]. Despite this spectacular progress it remains often cumbersome to extract the ring relations in terms of a minimal basis of generators in a systematic way.

In this paper we propose an alternative approach to study the Coulomb branch and the Higgs branch of 3d $\mathcal{N} = 4$ theories using in a new way the realization of the theories as the low-energy theory of D3 branes stretched between NS5 and D5 branes in type IIB string theory. This elegant brane realization introduced by Hanany and Witten [16] is particularly useful to study mirror symmetry which is realized as S-duality in IIB string theory, leaving the D3 branes invariant and exchanging the D5 and NS5 branes. Using the brane construction and the action of S-duality the Higgs and Coulomb branches of large classes of quiver theories were identified as moduli spaces of solutions of Nahm’s equations, namely intersections of (the closure of) nilpotent orbits and Slodowy slices [17, 18].³ Here we use the brane picture in a spirit closer to [20], where half-BPS loop operators were realized with F1 or D1 string arrays added to the brane configuration of the theory. The path integral insertion of a loop operator was then understood as arising from integrating out the light modes on the strings in the brane configuration. This approach proved to be very useful in understanding the action of mirror symmetry on loop operators, using IIB S-duality. The idea that we develop is that local half-BPS operators can be engineered in a similar way, by adding extra ingredients in the brane realization of the 3d theory and integrating out light modes. From these new brane setups we are able to extract the chiral ring relations and the mirror map between Higgs branch and Coulomb branch operators.

For simplicity we focus our analysis on quiver theories with abelian gauge nodes, except in the last section of the paper where we derive some preliminary results for non-abelian theories. In the brane picture the D3 branes are stretched between NS5 branes and span a finite interval in one direction. The three dimensional theory arises

³See also [19] for an application of the brane formalism to study an inclusion relation for nilpotent orbits associated to minimal singularities and related to higgsings of the quiver theories.

in low-energy limit of the D3 branes worldvolume theory. Using previous results in the literature and some simple arguments, we show that the chiral meson operators, or HB (Higgs branch) operators, are inserted from F1 strings stretched between pairs of D5 branes and ending on the D3 segments along the finite direction (e.g. Figure 5), or by D3 branes, that we call D3', intersecting the initial D3 segments at points. For the CB (Coulomb branch) operators we show that chiral monopole operators are inserted from D1 strings stretched between pairs of NS5 branes and ending on the D3 segments (e.g. Figure 8-a), while scalar operators are realized by D3 branes, that we call D3'', intersecting the initial D3 segments at a point (e.g. Figure 8-c). The specific orientations of the F1, D3', D1 and D3'' preserve four out of the eight supercharges⁴, as appropriate to realize the insertion of half-BPS operators, and are given in Table 2⁵. In a few places in our derivation we have to rely on indirect arguments or motivated assumptions, which are ultimately validated by the global consistency of the emerging picture.

Having understood how to realize the insertion of the operators forming bases of the Higgs branch and Coulomb branch, we proceed to studying the brane setups related to ring relations. For the Higgs branch there are two types of setups to consider. The F-term relations (or complex D-term equations) follow from identifying brane setups related by D3' brane moves along the interval direction, involving Hanany-Witten F1 string creation effects as a D3' passes through a D5 (e.g. Figure 10). The other HB relations, which are trivial in the sense that they involve only recombining products of hyper-multiplet scalars in different products of mesons, can be related to multiple interpretations of a given brane setup with F1 strings (e.g. Figure 9). The different interpretations can be associated to different recombinations of the F1 strings across D3 and D5 branes. For the Coulomb branch there is a single type of brane setups to consider, involving D1 branes (e.g. Figure 11), and the CB relations follow from interpreting each setup in two different ways: either as several semi D1 branes ending on D3s inserting a product of monopole operators, or as D1 branes crossing D3s. In this latter case we are able to integrate out the low-energy zero-dimensional theory arising from open string light modes and to show that the resulting insertions are polynomials in the complex scalars. There are also relations following from D1 brane recombinations across NS5 branes. This approach provides a new derivation of the quantum Coulomb branch relations. To be precise the relations that we extract from brane setups are not directly the exact ring relations, we therefore call them *pre-*

⁴The F1 and D3' preserve four supercharges. The D1 and D3'' preserve four supercharges. The two sets have two common supercharges.

⁵There are actually many choices of brane orientations, related by $SO(3)$ rotations, corresponding to different choices of complex structures/ $\mathcal{N} = 2$ sub-algebras under which the operators are chiral.

relations. The exact relations are obtained by allowing the cancellation of operators which appear multiplicatively on both sides of a pre-relation ($AC = BC \Rightarrow A = B$). At the end of our analysis we are left with a small set of rules from which one can extract the HB and CB relations in abelian quiver theories from a few brane setups. The dictionary between brane setups and operator insertions is summarized in Appendix B. It might be worth emphasizing that, to our knowledge, this brane approach provides the first derivation of the Coulomb branch relations in a large class of abelian quiver theories⁶ which does not rely dualities.

This brane approach is also particularly useful to study mirror symmetry. Acting with S-duality on the type IIB brane setups responsible for the insertions of the chiral operators, one finds the map between HB and CB operators of mirror dual theories with no effort. Under S-duality the F1 strings are simply mapped to D1 strings, and the D3' branes are mapped to D3" branes. It also immediately follows from IIB S-duality that the "trivial" HB ring relations are mapped to the quantum CB ring relations.

We study non-abelian theories in the last section of the paper and provide a derivation of the abelianized relations, postulated in [12], in the SQCD theory from a set of simple brane setups. We also comment on the a possible analogue approach to deriving the Higgs branch relations in non-abelian theories.

The approach presented in this paper could be extended to study the moduli space of vacua of other $\mathcal{N} = 4$ theories. The generalization to non-abelian theories is not straightforward, in particular in the analysis of the ring relations beyond what we found in this paper, however it should be possible to find the brane setups inserting the chiral operators and the mirror map. It would also be interesting to study the moduli space of $\mathcal{N} = 4$ Chern-Simons theories with matter which also have a brane realization in IIB string theory (with $(1, \pm 1)$ 5branes). Considering brane setups realizing 3d theories with only $\mathcal{N} = 2$ supersymmetry or operator insertions preserving a smaller amount of supersymmetry might be interesting directions to investigate. The direct computation of correlators of Higgs branch operators from supersymmetric localization in [21] is also a very fruitful approach. It could be extended to the study of correlators of monopole operators and should reproduce the CB ring relations. We hope to report on some of these topics in future publications.

After a brief review on the Higgs and Coulomb branches of 3d $\mathcal{N} = 4$ theories in Section 2, we study the brane configurations in type IIB responsible for the insertion of half BPS local operators in Section 3, identifying the F1 string and D3' branes as the objects inserting HB operators, and the D1 and D3" branes as the object inserting CB

⁶A direct derivation of the Coulomb branch relation in $\mathcal{N} = 4$ SQED using CFT methods was given in [3].

operators. We then start the discussion in Section 4 with the analysis of the $T[SU(2)]$ theory. We identify the brane setups inserting specific HB and CB operators and work out the ring relations from other brane setups. We explain how the mirror map of operators follows from S-duality ($T[SU(2)]$ is a self-mirror theory). In Section 5 we extend the discussion to other abelian theories. We study in detail the cases of SQED and its mirror dual abelian quiver theory. At this point all the rules for operator insertions and ring relation readings for (linear) abelian quiver theories are derived. We illustrate our method in another example at the end of the section. In Section 6 we discuss briefly the brane setups inserting chiral operators which do not belong to the bases of the chiral rings, such as monopole operators with non-minimal magnetic charges, or products of mesons. Finally in Section 7 we provide a preliminary analysis of the non-abelian theories, by recovering the SQCD abelianized relations of [12] from a brane setup. Some computations are relegated to Appendix A. The dictionary between brane setups and HB/CB operator insertions and the general mirror map are presented in Appendix B.

2 Light review on $\mathcal{N} = 4$ theories and their moduli space of vacua

A three-dimensional Yang-Mills theory with $\mathcal{N} = 4$ supersymmetry with gauge group G has an algebra-valued vector multiplet, whose bosonic fields are a vector A^μ and three real scalars ϕ_1, ϕ_2, ϕ_3 , transforming in the adjoint representation of G . The matter fields come in hyper-multiplets, whose bosonic fields are two complex scalars Q, \tilde{Q} transforming in complex conjugate representations $\mathcal{R}, \bar{\mathcal{R}}$ respectively⁷. In term of these data, the Lagrangian of the theory is uniquely fixed. The couplings of the theory are the Yang-Mills couplings $g_{\text{YM}}^{(i)}$ for each semi-simple factor in the gauge group. The couplings $g_{\text{YM}}^{(i)2}$ have the dimension of a mass, implying that the theories are asymptotically free and strongly coupled at low energies.

The R-symmetry group is $SU(2)_C \times SU(2)_H$, with (ϕ_1, ϕ_2, ϕ_3) transforming in the $(\mathbf{3}, \mathbf{1})$ and (Q, \tilde{Q}^\dagger) transforming in the $(\mathbf{1}, \mathbf{2})$. There also exists *twisted* vector and hyper-multiplets, for which the roles of $SU(2)_C$ and $SU(2)_H$ are exchanged.

The moduli space of vacua of these theories is parameterized by the vevs of scalar operators, including monopole operators. It is given by a union of subspaces (branches) of the form $\mathcal{C}_n \times \mathcal{H}_n$, where, in broad lines, \mathcal{C}_n is parametrized by the vev of a certain subset of the vector multiplet scalars and monopole operators, while \mathcal{H}_n is parametrized

⁷This is not the most general situation. In general a hyper-multiplet has a complex scalar transforming in a pseudo-real representation \mathcal{R}_{pr} of G . In this paper we focus on theories with $\mathcal{R}_{\text{pr}} = \mathcal{R} \oplus \bar{\mathcal{R}}$.

by the vev of a subset of the hyper-multiplet scalars. These subspaces intersect on lower-dimensional loci and the total moduli space is $\mathcal{M} = \cup_n(\mathcal{C}_n \times \mathcal{H}_n)$. There are two particular subspaces: the *Coulomb branch* $\mathcal{M}_C \simeq \mathcal{C} \times \{0\}$, where all hyper-multiplet scalar vevs are zero, and the *Higgs branch* $\mathcal{M}_H \simeq \{0\} \times \mathcal{H}$, where all vector multiplet scalar vevs and monopole vevs are zero. The other subspaces are called *mixed branches*. The R-symmetry group $SU(2)_C$ acts non-trivially on the Coulomb branch \mathcal{M}_C , as well as on the subspaces \mathcal{C}_n , and acts trivially on \mathcal{M}_H and the subspaces \mathcal{H}_n . Conversely the R-symmetry group $SU(2)_H$ acts non-trivially on the Higgs branch \mathcal{M}_H , as well as on the subspaces \mathcal{H}_n , and acts trivially on \mathcal{M}_C and the subspaces \mathcal{C}_n . We will focus our discussion on the Coulomb and Higgs branches, the extension to the mixed branches being straightforward. The Coulomb and Higgs branches are hyper-Kähler spaces, with the three complex structures transforming as triplets of $SU(2)_C$ and $SU(2)_H$ respectively.

The Higgs branch is protected from quantum corrections and can be studied from the classical Lagrangian. It is parametrized by the vevs of the $4N$ real hyper-multiplet scalars, with $N = \dim(\mathcal{R})$, satisfying the triplet of D-term equations, and modulo gauge transformations. This defines the Higgs branch as the hyper-Kähler quotient $\mathbb{R}^{4N} // G$. At a generic point on the Higgs branch the gauge group is completely broken and the low-energy theory is that of free hyper-multiplets. Often one describes the Higgs branch in an equivalent but simpler way, as a holomorphic quotient $\mathbb{C}^{2N}/G_{\mathbb{C}}$, by choosing a $\mathcal{N} = 2$ subalgebra of the $\mathcal{N} = 4$ super-algebra and parametrizing the Higgs branch by the vevs of the $2N$ complex scalars which are chiral with respect to this subalgebra, imposing the $\mathcal{N} = 2$ F-term equation (or complex D-term equation) and quotienting by complex gauge transformations. The gauge invariant combinations of the chiral scalar operators form a ring, the Higgs branch chiral ring, and their vevs are holomorphic functions on the Higgs branch moduli space \mathcal{M}_H . There is a $\mathbb{C}\mathbb{P}^1$ worth of choices of $\mathcal{N} = 2$ subalgebras, each corresponding to a choice of complex structure on \mathcal{M}_H .

At a generic point on the Coulomb branch the gauge group is broken to a maximal torus $U(1)^{\text{rank}(G)}$ and the matter fields are massive. The deep infrared theory is then described by free abelian vector multiplets⁸. Classically the Coulomb branch is the symmetric product of $\text{rank}(G)$ $U(1)$ Coulomb branches $(\mathbb{R}^3 \times S^1)^{\text{rank}(G)}/W_G$, where the factors $\mathbb{R}^3 \times S^1$ are parametrized by the Cartan components of the scalars ϕ_1, ϕ_2, ϕ_3 and by the dual photons (compact scalar dual to the Cartan vector fields), and W_G is the Weyl group of G , permuting the Cartan elements. The Coulomb branch receives quantum corrections which modify the geometry and in particular the topology of the classical description. A construction was presented in [12] to describe the Coulomb

⁸The abelian vector multiplets can be dualized to twisted hyper-multiplets

branch as a complex algebraic variety. It involves the choice of complex structure on \mathcal{M}_C , or equivalently the choice of an $\mathcal{N} = 2$ subalgebra of the $\mathcal{N} = 4$ theory. As for the Higgs branch, there is a \mathbb{CP}^1 worth of choices of complex structures (since \mathcal{M}_C is hyper-Kähler). The Coulomb branch is then parametrized by monopole operators which are chiral with respect to the $\mathcal{N} = 2$ subalgebra, subject to ring relations. The chiral (half-BPS) monopoles are defined in the quantum theory by the prescription in the path integral of a Dirac monopole singularity for the Cartan elements of the vector field and a corresponding singularity for one of the real scalars in the vector multiplet. The monopole singularity breaks the gauge group to a subgroup G' . To complete the definition such an operator is dressed with a G' -invariant polynomial of the complex scalar (which combines the two remaining vector multiplet scalars) valued in G' . This defines a monopole operator $V_{A,p}$ labeled by a vector of monopole charges $A \in \mathbb{Z}^{\text{rank}(G)}$ and a G' invariant polynomial p . When $A = 0$, the monopole operator is simply a gauge invariant polynomial in the vector multiplet complex scalars. Linear combinations of the chiral monopole vevs define holomorphic functions on \mathcal{M}_C . The ring of monopole operators can be called Coulomb branch chiral ring. Unlike the Coulomb branch metric, the ring relations are independent of the gauge coupling constants. They can be computed using the method of [12]. For abelian theories, which is our primary interest in this paper, the ring relations are explicitly given in [12].

In the UV description, the theories have global symmetries $U(1)^{\text{rank}(G)} \times G_H$, where the $U(1)$ factor acts by shifting the dual photons and G_H is the flavor symmetry acting on the hyper-multiplets. In the infrared theory, the global symmetry group is enhanced to $G_C \times G_H$, where G_C acts on monopole operators. Therefore the group G_C acts on the Coulomb branch, while the group G_H acts on the Higgs branch.

The theories admit supersymmetry preserving deformations by mass terms, with triplets of (real) mass parameters m_1, m_2, m_3 , and by FI terms, with triplets of (real) FI parameters ξ_1, ξ_2, ξ_3 . These deformations can be understood as arising from weakly gauging the Cartan subgroup of the G_H and G_C symmetry respectively. The triplets are then identified with the vevs of scalars in background vector multiplets. A triplet (m_1, m_2, m_3) is the background of a regular vector multiplet and therefore transforms as a triplet of $SU(2)_C$, but a triplet (ξ_1, ξ_2, ξ_3) is the background of a twisted vector multiplet and therefore transforms as a triplet of $SU(2)_H$ instead. The mass deformations lift part (or all) of the Higgs branch and modify the geometry on the Coulomb branch. In particular, in a chosen complex structure, a complex combination $m_{\mathbb{C}}$ appear as a deformation parameter in the CB relations. The FI deformations lift part (or all) of the Coulomb branch and affect the geometry on the Higgs branch. In a chosen complex structure, a complex combination $\xi_{\mathbb{C}}$ appear as a deformation parameter in

the HB relations.

In the following we will study exclusively linear quiver gauge theories with unitary nodes (and for most of the discussion only abelian theories). This means that the gauge group is of the form $G = \prod_{i=1}^P U(N_i)$ and that the matter content comprises only fundamental and bifundamental hyper-multiplets. A fundamental hyper-multiplet of the $U(N_i)$ node transforms in the representation $\mathbf{N}_i \oplus \overline{\mathbf{N}}_i$. A bifundamental hyper-multiplet of the $U(N_i) \times U(N_j)$ nodes transforms in the representation $(\mathbf{N}_i, \overline{\mathbf{N}}_j) \oplus (\overline{\mathbf{N}}_i, \mathbf{N}_j)$. Such quivers are conveniently described by quiver diagrams, where circles denote gauge nodes, squares denote flavor nodes, and links between two circles, or between a circle and a square, denote bifundamental hyper-multiplets. In this language a bifundamental hyper-multiplet for gauge-flavor nodes $U(N)_{\text{gauge}} \times U(M)_{\text{flavor}}$ is the same as M fundamental hypermultiplets of the $U(N)_{\text{gauge}}$ gauge node. Moreover we will focus on quiver theories of A type, namely linear quivers. In this case the matter content comprises one bifundamental hyper-multiplets for each pair of nodes $U(N_i) \times U(N_{i+1})$ and arbitrary numbers of fundamental hyper-multiplets. The generic quiver diagram is shown in Figure 1.

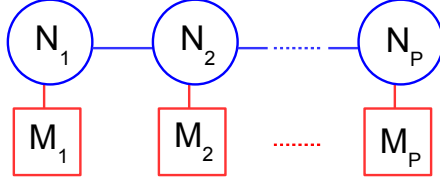

Figure 1. General linear quiver.

3 The brane realization of half-BPS local operator insertions

The linear quiver theories described by the general quiver diagram of Figure 1 arise as the low-energy theory of brane arrays in type IIB string theory [16]. The configurations involve D3 branes stretched between NS5 branes and intersecting D5 branes, with the orientations given in Table 1.

A $U(N_i)$ gauge node is associated to N_i D3 branes stretched between two NS5s. The fundamental hypermultiplets are the light modes of D5-D3 open strings. The bifundamental hyper-multiplets are the light modes of D3-D3 open strings stretched across NS5 branes. The 3d quiver theory is the low-energy theory on the D3-brane worldvolume, along the $x^{0,1,2}$ directions common to all branes. The general construction

	0	1	2	3	4	5	6	7	8	9
D3	X	X	X	X						
D5	X	X	X		X	X	X			
NS5	X	X	X					X	X	X

Table 1. Brane array realizing 3d $\mathcal{N} = 4$ A-type quiver theories.

is illustrated in Figure 2, which realizes the generic linear quiver theory of Figure 1 in the three nodes case ($P = 3$).

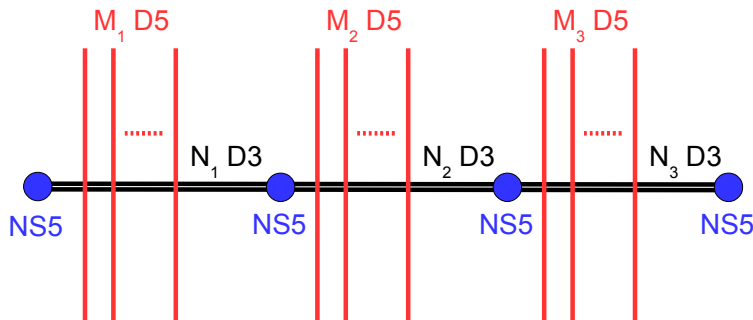

Figure 2. Brane configuration associated to a general linear quiver with three nodes.

3.1 Branes and strings inserting half-BPS local operators

We have reviewed how a 3d $\mathcal{N} = 4$ quiver theory can be engineered by a brane configuration in type IIB string theory. In various studies, including studies of 4d $\mathcal{N} = 4$ Super-Yang-Mills and 4d $\mathcal{N} = 2$ theories [22, 23], it was found that the insertion of BPS loop operators and surface defects have a realization in terms of brane configurations in string or M theory, in the sense that integrating out the light degrees of freedom of the brane configuration results in the insertion of the loop or surface operator in the path integral of the theory. For three-dimensional $\mathcal{N} = 4$ theories the brane configurations associated to the insertion of half-BPS Wilson loops and Vortex loops were constructed in [20]. It is natural to assume that also the local half-BPS operators have a realization in terms of certain brane setups.

To realize the insertion of half-BPS local operators, namely local operators preserving four out of the eight supercharges of the 3d theory, we need to include in the setup extra branes and/or strings with two properties:

- Their orientation must preserve four type IIB supercharges. In particular extra D-branes must (at least) be oriented such that the numbers of ND (Neumann-

Dirichlet) directions with the D3s and with the D5s in the configurations are multiples of four. For extra fundamental strings (F1s), one can consider the S-dual brane configurations, where they become D1s, to apply this criteria.

- Their intersection with the D3s must be in a point or along the direction x^3 , in which the D3s have a finite extent. This ensures that the extra brane or string sits at a point in the space $x^{0,1,2}$, which supports the low-energy 3d theory, and therefore inserts a local operator in the 3d theory.

These constraints select four possible extra ingredients, which are fundamental strings (F1s), D1-branes and two types of D3-branes, that we denote D3' and D3'', with the orientations given in Table 2. There are actually other possible choices of

	0	1	2	3	4	5	6	7	8	9
D3	X	X	X	X						
D5	X	X	X		X	X	X			
NS5	X	X	X					X	X	X
F1				X	X					
D3'					X			X	X	X
D1				X				X		
D3''					X	X	X	X		

Table 2. Brane array for 3d $\mathcal{N} = 4$ theories and half-BPS local operators.

orientation, corresponding to rotations in (x^4, x^5, x^6) and (x^7, x^8, x^9) , and preserving different supercharges. These choices of orientation are mapped to the choices of $\mathcal{N} = 2$ subalgebra in the $\mathcal{N} = 4$ theory reviewed in Section 2. We will stick to the orientations displayed in Table 2 in our discussion. Note that these extra branes or strings are extended only along spacial directions, as appropriate to include point-like operators.

The selection criteria applied above to preserve supersymmetry are necessary but may not be sufficient. To confirm that these configurations really preserve four supercharges, one needs to check that the projection on the IIB supercharges imposed by each additional brane in the D3-D5-NS5 setup is satisfied by four supercharges. Let us denote by $\epsilon, \tilde{\epsilon}$ the two 32-components Weyl spinors parametrizing the supersymmetries of IIB string theory. We introduce Γ^A , $A = 0, 1, \dots, 9$, the ten-dimensional gamma matrices and $\Gamma^{11} = -\Gamma^0\Gamma^1 \dots \Gamma^9$ the chirality matrix. We work here in $(- + + \dots +)$ signature ⁹. The Weyl spinors have the same chirality $\Gamma^{11}\epsilon = \epsilon$ and $\Gamma^{11}\tilde{\epsilon} = \tilde{\epsilon}$. The

⁹We perform the analysis of brane supersymmetries in the more familiar Lorentzian space. However the field theory discussion is based on the Euclidean theory, so one could adapt the analysis by implementing a Wick rotation in the brane setup.

projections imposed by each brane on the spinors $\epsilon, \tilde{\epsilon}$ are the following

$$\begin{aligned}
\underline{D3} : & \quad \epsilon = \Gamma^{0123} \tilde{\epsilon}, \\
\underline{D5} : & \quad \epsilon = \Gamma^{012456} \tilde{\epsilon}, \\
\underline{NS5} : & \quad \epsilon = \Gamma^{012789} \epsilon, \quad \tilde{\epsilon} = -\Gamma^{012789} \tilde{\epsilon}, \\
\underline{F1} : & \quad \epsilon = -i\Gamma^{34} \epsilon, \quad \tilde{\epsilon} = i\Gamma^{34} \tilde{\epsilon}, \\
\underline{D1} : & \quad \epsilon = i\Gamma^{37} \tilde{\epsilon}, \\
\underline{D3'} : & \quad \epsilon = i\Gamma^{4789} \tilde{\epsilon}, \\
\underline{D3''} : & \quad \epsilon = i\Gamma^{4567} \tilde{\epsilon},
\end{aligned} \tag{3.1}$$

where we defined $\Gamma^{A_1 A_2 \dots A_n} = \Gamma^{A_1} \Gamma^{A_2} \dots \Gamma^{A_n}$, for $A_1 \neq A_2 \neq \dots \neq A_n$. The projections associated to Euclidean branes or strings differ from the projections associated to Lorentzian branes by an extra factor of i , which follows from a Wick rotation. The NS5 brane projections were given in [16]. The projection due to the fundamental string can be worked out from the Green-Schwarz super-string action in light-cone gauge: in type IIB string theory there are twice sixteen supercharges, the two sets satisfying opposite 2d chirality projections on the worldsheet (which in this case is extended along the x^3 and x^4 directions) and forming the two ten-dimensional spinors.

Solving the system of equations for each configuration¹⁰, one finds that the (D3-D5-NS5)-F1 setup and the (D3-D5-NS5)-D3' setup preserve the same four supercharges, say Q_1, Q_2, Q_3, Q_4 , and that the (D3-D5-NS5)-D1 setup and the (D3-D5-NS5)-D3'' setup also preserve four identical supercharges, with two common supercharges with the previous setups, say Q_1, Q_2, Q_5, Q_6 . This shows that the setup with both F1s and D3's preserve four supercharges, that the setup with both D1s and D3''s also preserve four supercharges, and that a setup with F1, D1, D3' and D3'' still preserves two supercharges Q_1, Q_2 . We will restrict to studying setups with F1s and D3's, or D1s and D3''s.

In the next section we will find that the insertion of Higgs and Coulomb branch operators are realized by F1-D3' and D1-D3'' setups respectively. Not surprisingly, the F1-D3' setups are mapped to D1-D3'' setups under S-duality of IIB string theory.

To conclude this discussion on the brane setups, it is important to discuss the Hanany-Witten (HW) brane creation effects [16] arising in the above configurations. The Hanany-Witten effect in the D3-D5-NS5 setup is the phenomenon of D3 brane creation, stretched between a D5 and an NS5 branes, as the two 5-branes pass through

¹⁰We used an explicit representation of the Gamma matrices and solved the systems of equations in Mathematica.

each-other. Consider a configuration with a D5 on the left and an NS5 on the right in the x^3 direction, with N_D and N_{NS} the net numbers¹¹ of D3s ending on the D5 and NS5 respectively. After moving the two 5-branes across each other, the new net numbers N'_D, N'_{NS} are given by $N'_D = N_D - 1$, $N'_{NS} = N_{NS} + 1$, due to the creation of one D3 brane stretched between them. Using T-dualities and S-duality of string theories, one can generate various dual setups where this brane/string creation effect happens [24, 25], with different explanations of the effect in different setups. In the setups described above we have three such HW effects:

- the D3-D5-NS5 system, with D3 brane creation, arising in the initial brane setup realizing the quiver theories;
- the F1-D3'-D5 system, with F1 string creation stretched between the D3' and the D5;
- the D1-D3''-NS5 system, with D1 brane creation stretched between the D3'' and the NS5.

The two latter situations are related by S-duality. These HW effects are depicted in Figure 3. They will play a role in our analysis. There is no other brane creation effects in the setups that we study.

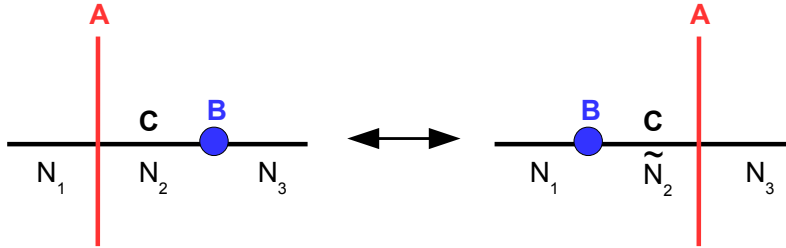

Figure 3. Hanany-Witten brane creation effect. The triplet of branes (A, B, C) can be either $(D5, NS5, D3)$, or $(D3', D5, F1)$, or $(D3'', NS5, D1)$. As the A and B branes pass across each other the number of C branes stretched between them goes from N_2 to $\tilde{N}_2 = N_1 + N_3 - N_2 + 1$.

In HW configurations with a triplet of branes (A, B, C) and C brane creation effect, the lowest mode on a C brane stretched between an A and a B brane is fermionic. This implies the so-called *s-rule*, stating that there can be at most one C brane stretched between an A and a B brane at low energies.

¹¹The net number is the number ending on the left minus the number ending on the right in the x^3 direction.

4 Analysis in the $T[SU(2)]$ theory

To start with we consider in this section the simple setup of a $U(1)$ gauge theory with two fundamental hyper-multiplets with complex scalars $(Q^\alpha, \tilde{Q}_\alpha)$, $\alpha = 1, 2$, also called $T[SU(2)]$ theory. The brane realization of this theory is shown in Figure 4. It has two D5s intersecting a single D3. We denote $D5_{(1)}$ the D5 on the left in the figure and $D5_{(2)}$ the D5 on the right.

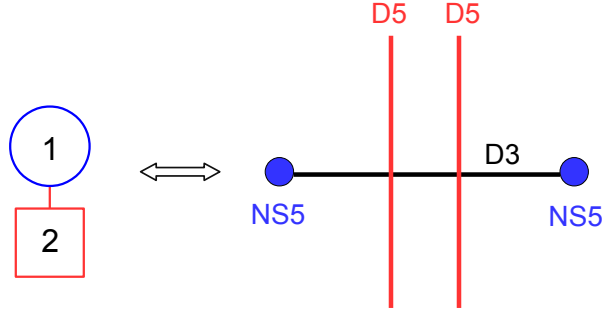

Figure 4. Quiver and brane configuration for the $T[SU(2)]$ theory.

4.1 Higgs branch operators

The operators whose vevs parametrize the Higgs branch, or HB operators, are the mesons

$$Z^\alpha{}_\beta = \tilde{Q}_\beta Q^\alpha, \quad \alpha, \beta = 1, 2, \quad (4.1)$$

which satisfy by definition the relation

$$\det Z \equiv Z^1{}_1 Z^2{}_2 - Z^2{}_1 Z^1{}_2 = 0, \quad (4.2)$$

and are subject to the F-term constraint

$$\text{Tr } Z \equiv Z^1{}_1 + Z^2{}_2 = 0. \quad (4.3)$$

We claim that the meson operator insertions are realized by the following brane setups:

- The operators $Z^2{}_1$ and $-Z^1{}_2$ are realized with a single semi-infinite F1 string stretched between the two D5s and ending on the D3 from above and from below respectively, as shown in Figure 5.
- The operator $-Z^1{}_1$ is realized with one infinite F1 string extended on the left of the configuration and ending on $D5_{(1)}$, as shown in Figure 6-a. The meson

operator Z^2_2 is realized with one infinite F1 string extended on the right of the configuration and ending on $D5_{(2)}$, as shown in Figure 6-b.

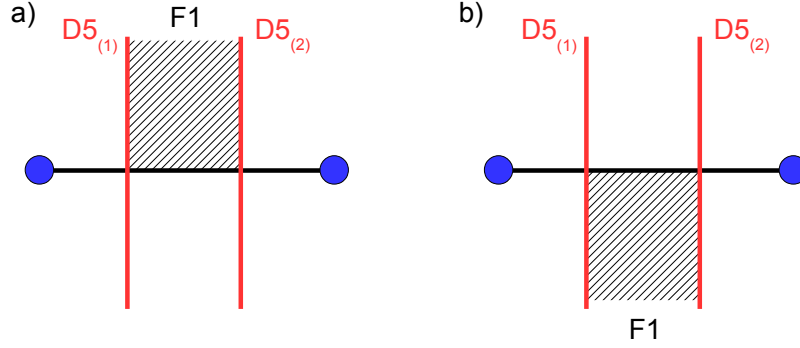

Figure 5. Brane configurations for the insertion of the meson operators (a) Z^2_1 and (b) $-Z^1_2$.

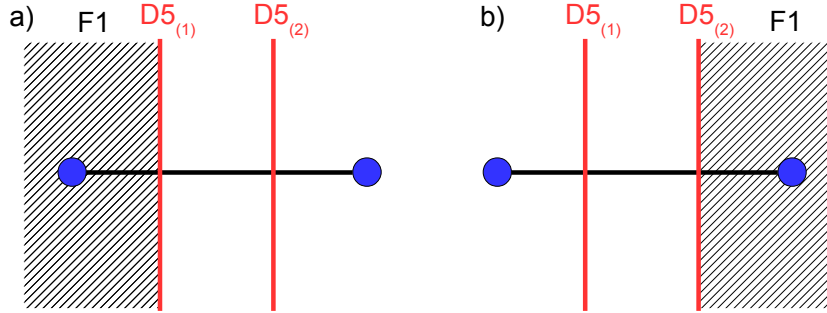

Figure 6. Brane configurations for the insertion of the meson operators (a) $-Z^1_1$ and (b) Z^2_2 .

We will not provide a direct derivation of these results from string perturbation theory. Instead we will rely on known results and consistency arguments leading to the proposals and the observation that they are consistent with expectations.

First we recall the result in [22] that a configuration with a semi-infinite F1 string ending on a stack of N D3s is responsible for the insertion a half-BPS Wilson loop in the fundamental representation of $U(N)$, in the four-dimensional low-energy theory on the D3s¹².

Let us be more precise. With D3s along $x^{0,1,2,3}$, the low-energy theory on the D3s is the four-dimensional $\mathcal{N} = 4$ $U(N)$ SYM theory. The bosonic fields are the 4d gauge

¹²The simplest brane configuration studied in [22] has a string stretched between a stack of N D3s and a single D3 at a large distance. Here we think of the extra D3 brane as being sent to infinity, leaving only a semi-infinite F1 string ending on the stack of N D3s.

field A_μ and the six real scalars ϕ_i , $i = 4, \dots, 9$, corresponding to the D3 motions along the $x^{4,5,6,7,8,9}$ directions, all valued in the $\mathfrak{u}(N)$ algebra.

A semi-infinite F1 string spanning the directions x^3 and $x^4 > 0$, ending on the D3s at $x^4 = 0$, inserts in the path integral of the SYM theory the half-BPS Wilson loop in the fundamental representation¹³

$$W_{\text{fund}} = \text{Tr}_{\text{fund}} \mathcal{P} \exp \left(\int_{-\infty}^{\infty} dx^3 (iA_3 + \phi_4) \right), \quad (4.4)$$

where Tr_{fund} is the trace in the fundamental representation and A_3 is the component of the gauge field along the direction x^3 . When there is a single D3 brane, the string inserts the Wilson loop $\mathcal{P} \exp \int_{-\infty}^{\infty} dx^3 (iA_3 + \phi_4)$ in the abelian $\mathcal{N} = 4$ SYM theory.

Similarly we can consider a stack of K D5s along the directions $x^{0,1,2,4,5,6}$ in the presence of a semi-infinite F1 string along the directions $x^3 < 0$ and x^4 , ending on the D5s at $x^3 = 0$. The computation in [22] carries over to this situation, concluding that this setup corresponds to the insertion of a half-BPS Wilson loop in the fundamental representation of the 6d $U(K)$ SYM theory living on the D5s. In the abelian case, $K = 1$, the Wilson loop is

$$W_{D5} = \exp \left(\int_{-\infty}^{\infty} dx^4 (iA_4^{(D5)} + \phi_3^{(D5)}) \right), \quad (4.5)$$

where $A_4^{(D5)}$ is the component of the 6d gauge field along x^4 and $\phi_3^{(D5)}$ is the 6d scalar field associated to motion of the D5 along x^3 .

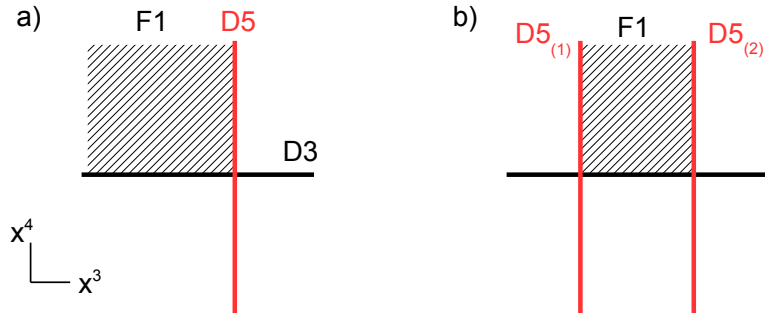

Figure 7. a) F1 string with a D3-D5 corner. b) F1 string with two D3-D5 corners.

The situation that we want to consider is slightly more complicated. We have both

¹³The factors of i differ from [22] due to the fact that the string is extended along two space directions here, instead of space and time there.

a D3 and a D5 brane, intersecting, say, at $(x^3, x^4) = (0, 0)$, and we stretch an F1 string along the $x^{3,4}$ directions such that it ends both on the D3 and on the D5, and has a D3-D5 corner. So the string spans, say, $x^3 < 0$ and $x^4 > 0$, as shown in Figure 7-a. At low-energies, we infer from the above analysis that this setup corresponds to the insertion of the product of Wilson loops

$$\exp\left(\int_{-\infty}^0 dx^3 (iA_3 + \phi_4)\right) \exp\left(\int_0^{\infty} dx^4 (iA_4^{(D5)} + \phi_3^{(D5)})\right), \quad (4.6)$$

where the 6d fields can be considered frozen to a background in the low-energy limit. However this cannot be the whole story, since this operator is not gauge invariant under the 4d or 6d gauge transformations: the integration contours of the Wilson loops have a common boundary at the point $P = (0, 0)$ where the F1, D3 and D5 meet. To restore gauge invariance, the insertion of an extra local field at the point P is needed, which transforms with charges $(-1, 1)$ under $U(1)_{D3} \times U(1)_{D5}$. The minimal extra insertion needed is with a bifundamental scalar, so we propose that the complete operator insertion is

$$\exp\left(\int_{-\infty}^0 dx^3 (iA_3 + \phi_4)\right) Q(P) \exp\left(\int_0^{\infty} dx^4 (iA_4^{(D5)} + \phi_3^{(D5)})\right), \quad (4.7)$$

where $Q(P)$ is the hypermultiplet complex scalar Q of charge $(-1, 1)$ under $U(1)_{D3} \times U(1)_{D5}$ living at the 3d intersection of the D3 and D5 branes, evaluated at P . This operator is gauge invariant and preserves half of the supersymmetries of the D5-D3 configuration.

If one consider the analogous situation of an F1 string stretched along $x^3 > 0$ and $x^4 > 0$ instead, the corresponding insertion would be

$$\exp\left(-\int_0^{\infty} dx^4 (iA_4^{(D5)} + \phi_3^{(D5)})\right) \tilde{Q}(P) \exp\left(\int_0^{\infty} dx^3 (iA_3 + \phi_4)\right), \quad (4.8)$$

where the change of sign (or charge) for the Wilson loop in the D5 theory is due to the fact that the F1 string now ends on the other side of the D5 brane. Here $\tilde{Q}(P)$ is the hypermultiplet complex scalar \tilde{Q} of charge $(1, -1)$ under $U(1)_{D3} \times U(1)_{D5}$ living at the 3d intersection of the D3 and D5 branes, evaluated at P , and preserving the same four supercharges as the preceding operator involving Q .

Finally we consider the situation when there is one D3 brane and two D5 branes, sitting at $x^3 = 0$ and $x^3 = L > 0$, with an F1 string stretched along $x^4 > 0$ and the finite interval $0 < x^3 < L$, ending on both D5s, as shown in Figure 7-b. The same considerations as above lead us to the conclusion that the half-BPS operator insertion

is

$$\exp\left(-\int_0^\infty dx^4 (iA_4^{(D5_1)} + \phi_3^{(D5_1)})\right) \tilde{Q}_1(P_1) \exp\left(\int_0^L dx^3 (iA_3 + \phi_4)\right) Q^2(P_2) \exp\left(\int_0^\infty dx^4 (iA_4^{(D5_2)} + \phi_3^{(D5_2)})\right), \quad (4.9)$$

where \tilde{Q}_1 is the 3d scalar of charge $(-1, 1)$ under $U(1)_{D3} \times U(1)_{D5_{(1)}}$ and Q^2 is the 3d scalar of charge $(-1, 1)$ under $U(1)_{D3} \times U(1)_{D5_{(2)}}$. The points P_1 and P_2 are the intersections of the F1, D3 and D5₁, and F1, D3 and D5₂, respectively. They have the same positions in all coordinates, except x^3 , with $x^3(P_1) = 0$ and $x^3(P_2) = L$.

This configuration, with one D3, two D5s at $x^3 = 0$ and $x^3 = L > 0$, and an F1 string stretched between them, is embedded in a setup where the D3 spans a finite interval in the x^3 direction, ending on two NS5s at positions $x_L^3 < 0$ and $x_R^3 > L$ (Figure 5-a). The boundary conditions on the 4d fields living on the D3 at x_L^3 and x_R^3 have been studied in [17]. They are of Neumann type for the vector field. We have¹⁴

$$A_3 = 0, \quad \phi_{4,5,6} = 0, \quad \partial_3 \phi_{7,8,9} = 0, \quad \partial_3 A_\mu = 0, \quad \mu = 0, 1, 2. \quad (4.10)$$

At low energies the 6d fields are non-dynamical and the 4d fields obey the constraints (4.10) on the whole interval $x_L^3 < x^3 < x_R^3$. The operator (4.9) then reduces to

$$\tilde{Q}_1(P_1) Q^2(P_2) \overline{W}_{D5_1} W_{D5_2}, \quad (4.11)$$

where \overline{W}_{D5_i} and W_{D5_i} denote the flavor Wilson loops of charge -1 and $+1$ under the $U(1)_{D5_i}$ respectively. In the 3d effective theory the points P_1 and P_2 are identified, $P_1 \sim P_2 \equiv x \in \mathbb{R}^3$. The flavor Wilson loops will play no role in our discussion, so we take them to be trivial (equal to one). We conclude that the brane configuration inserts the local meson operator

$$\tilde{Q}_1(x) Q^2(x) = Z^2_1(x). \quad (4.12)$$

The same analysis for the configuration with a semi-infinite F1 string spanning $0 < x^3 < L$ and $x^4 < 0$ (figure 5-b), where the Wilson loop in the D3 worldvolume theory has opposite charge, leads to the insertion of the half-BPS meson operator

$$-Q^1(x) \tilde{Q}_2(x) = -Z^1_2(x). \quad (4.13)$$

¹⁴The scalars $\phi_{4,5,6}$ can actually be fixed to non-zero constants at the boundaries, but we take these constants to be vanishing for simplicity.

The minus sign inserted here does not follow from our analysis, which is not sensitive to overall constants. We fix it by consistency with the analysis of ring relations that is presented in later sections.

The brane setup with an F1 string extended along $x^3 < 0$ and x^4 , ending on $D5_{(1)}$ on its left, as shown in Figure 5-a, can be understood as having two D3-D5₍₁₎ corners, one above and one below the D3, inserting the meson operator

$$-Q^1(x)\tilde{Q}_1(x) = -Z^1_1(x). \quad (4.14)$$

Again the minus sign is fixed by consistency with later analysis.

The brane setup with an F1 string extended along $x^3 > L$ and x^4 , ending on $D5_{(2)}$ on its right, as shown in Figure 5-b, can be understood as having two D3-D5₍₂₎ corners, one above and one below the D3, inserting the meson operator

$$Q^2(x)\tilde{Q}_2(x) = Z^2_2(x). \quad (4.15)$$

This interpretation requires the F1 string to lie at the same $x^{5,6}$ positions as the D3, so that it breaks in two pieces, both ending on the D3.

We recover all the insertions proposed at the beginning of the section. So far the D3' branes did not play a role in the HB operator insertions. They will enter into play when we study the HB relations and mirror symmetry.

4.2 Coulomb branch operators

We now turn to the Coulomb branch operators, or CB operators, of the $T[SU(2)]$ theory. A basis generating the CB chiral ring is given by three half-BPS (or chiral) scalar operators: the complex scalar φ and the abelian monopole operators u^\pm of monopole charge ± 1 . They are subject to the CB quantum relation

$$u^+u^- = -\varphi^2. \quad (4.16)$$

To realize the path integral insertion of the CB operators, we propose that the following brane setups:

- The u^+ and $-u^-$ ¹⁵ operator insertions are realized by adding a semi-infinite D1 brane stretched between the two NS5s and ending on the D3 from above and from below respectively, as shown in Figure 8-a and -b.

¹⁵The minus sign here is purely conventional (it could be eliminated by redefining u^-). We introduce it in order to get a simple mirror map with HB operators.

- The φ operator insertion is realized by adding a D3'' brane between the two NS5s, intersecting the D3 at a point, as shown in Figure 8-c.

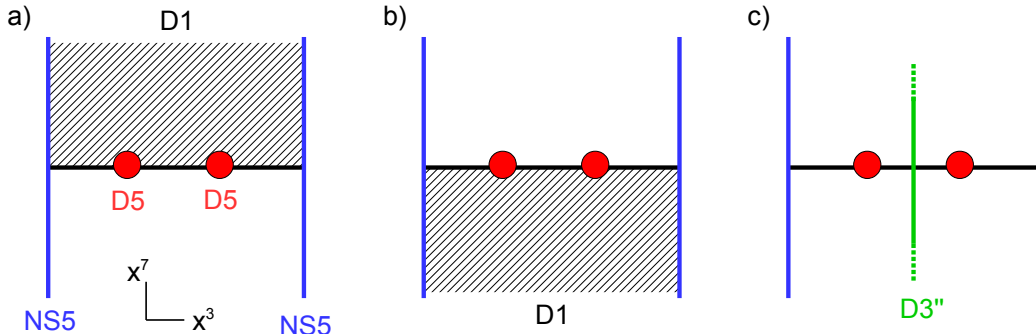

Figure 8. a) Semi infinite D1 ending on the D3 from above, inserting the monopole operator u^+ . b) Semi infinite D1 ending on the D3 from below, inserting the monopole operator $-u^-$. c) D3'' brane crossing the D3 at an arbitrary position in x^3 between the two NS5s, inserting the scalar operator φ .

To argue for the realization of monopole operator insertions, we start from the brane configuration with only a D3-brane and a semi-infinite D1, along x^3 and $x^7 > 0$, ending on it at $x^7 = 0$. At low energies on the worldvolume of the D3 lives the abelian 4d $\mathcal{N} = 4$ SYM theory. It is well-known [26] that a D1 brane stretched between two separated D3 branes can be associated to the presence of an $SU(2)$ half-BPS monopole of charge $(1, -1)$ under the $U(1)^2$ Cartan subalgebra, in the D3 worldvolume YM theory. The limit when one of the D3 brane is sent at infinity corresponds to the limit of infinitely small size of the monopole soliton, leaving a half BPS monopole line operator, called 't Hooft loop, in the 4d theory, with charge $+1$ (or -1). We pick the convention that the charge is $+1$ when the D1 ends on the D3 from above. This 't Hooft loop is defined as a Dirac monopole singularity of the abelian gauge field at each point on the x^3 line (here in Euclidean space),

$$F = \star d\left(\frac{1}{2r}\right), \quad r = \sqrt{(x^0)^2 + (x^1)^2 + (x^2)^2}, \quad (4.17)$$

and a corresponding singularity for the real scalar ϕ^7 corresponding to motions of the D3 along x^7 , and ensuring that the configuration preserves half of the supersymmetries.

In our situation the D3 and D1 span only a finite interval along x^3 since they end on the two NS5 branes. This means that the 4d theory with a unit charge 't Hooft loop lives on an interval with Neumann boundary conditions (4.10). These boundary conditions are compatible with the 't Hooft loop singularity. At low energies, the theory

becomes effectively three-dimensional and the loop operator becomes a local operator inserting a charge one Dirac monopole singularity and the corresponding singularity for the real scalar $\sigma \sim \phi^7$, preserving half of the supersymmetries. This is precisely the insertion of the u^+ monopole operator advertized above.

The insertion of the u^- monopole operator from a D1 ending on the D3 from below follows from the same argument, with the negative charge 't Hooft loop insertion in 4d.

The last configuration involves a D3'' crossing the D3 at an arbitrary point along x^3 between the two NS5s (Figure 8-c). We can analyse the spectrum of light string modes at the intersection point between D3 and the D3''. These branes have eight Neumann-Dirichlet directions, therefore the light string excitations corresponds to a single zero-dimensional fermion χ , with minimal coupling to the two 4d bulk SYM theories, preserving eight supercharges. These couplings can be worked out from the dimensional reduction to zero dimensions of the (8,0) Lagrangian of a 2d Weyl spinor, leading to

$$S_{0d} \sim \bar{\chi}(\Delta\phi^8 + i\Delta\phi^9)|_P\chi, \quad (4.18)$$

where $\Delta\phi^8 + i\Delta\phi^9$ can be understood as arising from the reduction of a 2d gauge field in Euclidean space¹⁶, and are identified in the brane picture with the relative motion between the D3 and D3'' in the directions x^8 and x^9 transverse to both branes. The scalar fields are evaluated at the point P corresponding to the location of the D3-D3'' intersection. In the low energy limit the 4d SYM theory on the D3'' is non-dynamical and the vector multiplet complex scalars are set to background values that we take to be vanishing. The scalar combination $\Delta\phi^8 + i\Delta\phi^9 = \phi^8 + i\phi^9$ then corresponds to the 3d vector multiplet complex scalar φ . Integrating out the complex fermion χ in the path integral leads to the insertion of the local operator $\phi^8 + i\phi^9 \sim \varphi$ at the point P .

$$\int d\bar{\chi}d\chi \exp[\bar{\chi}(\phi^8 + i\phi^9)|_P\chi] = (\phi^8 + i\phi^9)|_P \sim \varphi(P). \quad (4.19)$$

We conclude that the D3'' brane is associated to the insertion of the local operator φ in the low-energy limit. Here we have assumed that the D3'' interactions with the other branes in the configuration are irrelevant at low energies.

4.3 Ring relations

From the brane realizations of the Higgs and Coulomb branches operators of $T[SU(2)]$ described in the previous section, we can deduce the relations they obey.

¹⁶The two scalars are constant values of the 2d gauge field along the two space directions. In Lorentzian 2d space the combination appearing would be $\Delta\phi^8 + \Delta\phi^9$, but after Wick rotation this becomes $\Delta\phi^8 + i\Delta\phi^9$.

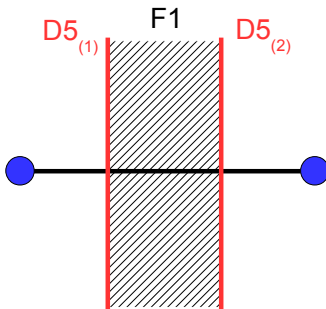

Figure 9. Setup for the operator $-Z^2_1 Z^1_2$ or equivalently $-Z^1_1 Z^2_2$.

First we explain how to find the relations of the Higgs branch, (4.2) and (4.3), which we repeat here for convenience:

$$\det Z \equiv Z^1_1 Z^2_2 - Z^2_1 Z^1_2 = 0, \quad \text{Tr } Z \equiv Z^1_1 + Z^2_2 = 0. \quad (4.20)$$

The first relation follows trivially from the definition of the meson operators in terms of the hyper-multiplet scalars. However we will see that this trivial relation is mapped under mirror symmetry to a non-trivial quantum relation on the Coulomb branch of the dual $T[SU(2)]$ theory. Therefore, to provide a unified picture between Higgs branch and Coulomb branch, we wish to find a way to recover the relation from the brane picture (as we will do for the CB relation). For that purpose we consider the setup with an infinite F1 string stretched between the two D5s and intersecting the D3, as in Figure 9. This brane configuration can be interpreted in two ways. First we can see it as two semi-infinite F1s ending on the D3. This leads, according to the discussion above, to the insertion of the meson operators Z^2_1 and $-Z^1_2$, which means the insertion of the product $-Z^2_1 Z^1_2$. Alternatively it can be seen as a single infinite F1 string, crossing the D3, in which case the insertion of meson operators can be associated to the two D5-D3 intersections with a full F1 ending on the D5. Re-using the arguments of section 4.1 one finds that the F1 ending on the right side of $D5_{(1)}$ inserts the operator Z^1_1 and the same F1 ending on the left side of $D5_{(2)}$ inserts the operator $-Z^2_2$. In section 4.1 we had a configuration with infinite F1 extended to the left or to the right and realizing $-Z^1_1$ and Z^2_2 separately. Here we have a single F1 string responsible for the insertion of the product of the two operators $-Z^1_1 Z^2_2$. The first Higgs branch relation $\det Z = 0$ follows from the identification of the two operator insertions: $-Z^2_1 Z^1_2 = -Z^1_1 Z^2_2$. These two “readings” of the same brane setup may seem artificial when one thinks in terms of (gauge non-invariant) scalars $Q^\alpha, \tilde{Q}_\alpha$ insertions. The purpose of this discussion is to

extract the rules to read ring relations directly in terms of gauge invariant operators. We will then show that parallel rules apply to Coulomb branch operators, making mirror symmetry transparent.

The second relation $\text{Tr } Z = 0$ follows from the F-term constraint in the gauge theory. We find it by first considering the brane setup for the operator $-Z^1_1$ (Figure 6-a), with an infinite F1 extended to the left and ending on $D5_{(1)}$. We can then let the string end on a $D3'$ brane far away to the left, without changing the operator insertion (and preserving the same supersymmetry), as in Figure 10-a. It was a crucial point in [16] to argue that the brane moves along the x^3 direction leave invariant the low-energy physics on the D3 branes, as long as branes of the same type do not cross each other (e.g. a D5 does not cross another D5). This property allows to derive 3d mirror symmetry from IIB string theory using S-duality and 5-brane moves along x^3 . Here we use this property to move freely the $D3'$ along x^3 , across the brane configuration, all the way to a far region on the right. As it passes through the two D5s, HW F1-creation effects occur, as explained in section 3.1: after crossing $D5_{(1)}$ the $D3'$ stands inbetween the two D5s with no F1 ending on it and after crossing $D5_{(2)}$, there is an F1 string stretched between $D5_{(2)}$ and the $D3'$. This process is depicted in Figure 10. The end configuration is the one inserting the operator Z^2_2 . Identifying the initial and final brane setups, we obtain the second relation $-Z^1_1 = Z^2_2$. Therefore the F-term relation follows from a $D3'$ brane move and involves the HW effects.

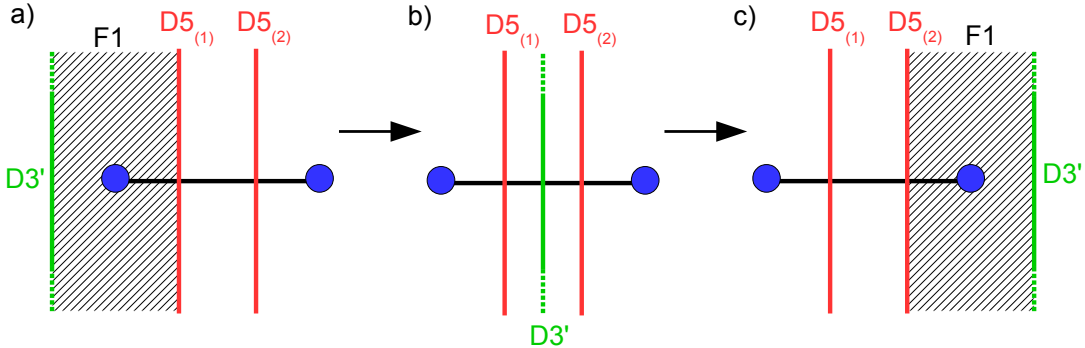

Figure 10. a) Setup realizing $-Z^1_1$, with a $D3'$ on the left of the configuration. b) Setup after moving the $D3'$ inbetween the D5s. c) Setup after moving the $D3'$ to the right, realizing Z^2_2 .

One may wonder what is the operator insertion corresponding to the brane setup with the $D3'$ brane standing between the two D5s and crossing the $D3$ segment as in the middle figure in Figure 10. It is a nice and instructive exercise to study this configuration. The operator insertion in this case is obtained after integrating out the light modes of the $D3'$ - $D3$ open strings. This brane system is almost identical to the

D3-D3' intersection studied above. The D3' and D3 branes intersect at a point in space and the light open string modes correspond to a single zero-dimensional fermion χ , whose zero dimensional action is

$$S_{0d} \sim \bar{\chi}(\phi^5 + i\phi^6)|_P \chi, \quad (4.21)$$

where P is the intersection point between the D3 and D3' and $\phi^5 + i\phi^6$ corresponds to the relative motion between the two branes in the direction $x^5 + ix^6$ and is identified simply with the D3 brane position along $x^5 + ix^6$ by placing the D3' at $(\phi^5 + i\phi^6)_{D3'} = 0$. The scalar $\phi^5 + i\phi^6$ then corresponds to a complex scalar in the 4d SYM theory on the D3 brane, which belongs to the 3d hyper-multiplet with complex scalars $(A_3 + i\phi^4, \phi^5 + i\phi^6)$ under the embedding of the 3d $\mathcal{N} = 4$ super-algebra into the 4d $\mathcal{N} = 4$ super-algebra. In the infrared limit the boundary conditions imposed by the NS5 branes and the D5 branes, studied in [17] are such that the complex scalar $\phi^5 + i\phi^6 \equiv \Phi$ vanishes at the NS5 brane positions, say at $x^3 = 0$ and $x^3 = L > 0$, $\Phi(0) = \Phi(L) = 0$, and to obey the equation¹⁷

$$\partial_3 \Phi + \delta(x_{(1)}^3) Z_1^1 + \delta(x_{(2)}^3) Z_2^2 = 0, \quad (4.22)$$

with $x_{(\alpha)}^3$ the position of $D5_{(\alpha)}$. This problem admits a solution only if $Z_1^1 + Z_2^2 = 0$, which is another way to recover the F-term constraint, and the profile of the scalar Φ is then

$$\Phi(x^3) = \begin{cases} 0 & , \quad 0 < x^3 < x_{(1)}^3, \\ -Z_1^1 & , \quad x_{(1)}^3 < x^3 < x_{(2)}^3, \\ -Z_1^1 - Z_2^2 = 0 & , \quad x_{(2)}^3 < x^3 < L. \end{cases} \quad (4.23)$$

The action for the 0d fermion χ is then

$$S_{0d} \sim \bar{\chi}(-Z_1^1)|_P \chi, \quad (4.24)$$

and produces, upon integrating out the fermion, the insertion of the meson operator $-Z_1^1(P) = Z_2^2(P)$ in complete agreement with the previous analysis. In this different point of view, the F-term constraint does not follow from identifying brane setups (which is our preferred point of view in this paper) but instead from solving the equations on the scalar Φ which becomes non-dynamical in the infrared limit.

We now move on to the Coulomb branch relations. There is actually a single relation for the $T[SU(2)]$ theory, found in [3], given by

$$u^+ u^- = -\varphi^2. \quad (4.25)$$

¹⁷We thank Davide Gaiotto for informative discussions on this point.

This non-trivial quantum relation can be recovered from a rather simple analysis of the brane realizations inserting the Coulomb branch operators. The relevant brane setup has a infinite D1 brane stretched between the two NS5s and crossing the D3, as in Figure 11. We can regard this configurations in two ways, that we detail now.

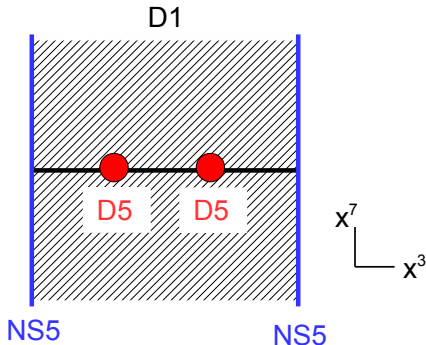

Figure 11. A D1 brane stretched between the two NS5s, crossing the D3 brane.

First we can see it as two semi-infinite D1s ending on the D3 from above and below respectively. According to the rules described before, this corresponds to the insertion of the product of two monopole operators $-u^+u^-$.

On the other hand we can regard the configuration as a single D1 stretched between the two NS5s and crossing the D3 and study the low-energy spectrum of the open strings stretched between the various branes. In the infrared limit, when the dynamic of the theory in the x^3 direction is frozen, the D1-D1 open string modes give rise to an abelian vector multiplet of 1d $\mathcal{N} = (4, 4)$ supersymmetry¹⁸ living on a line along the x^7 direction and intersecting the three-dimensional theory living on the D3 at a point.

The D1-D3 open strings give rise to a zero-dimensional hyper-multiplet¹⁹ transforming in the bifundamental representation of $U(1)_{1d} \times U(1)_{3d}$, where $U(1)_{1d}$ denotes the abelian gauge symmetry of the theory on the D1 and $U(1)_{3d}$ that of the theory living on the D3. The hyper-multiplet is coupled to 0d $\mathcal{N} = (4, 0)$ vector multiplets embedded in the 1d and 3d vector multiplets. The coupling to the bosonic 1d and 3d fields is through a complex mass coupling with mass parameter $\varphi' - \varphi$, where φ' combines two out of the five real scalars of the 1d vector multiplet. The difference $\varphi' - \varphi$ corresponds to the distance between the D1 and D3 branes along $x^8 + ix^9$. In the configuration that we study, we impose that the D1 crosses the D3, which means that $\varphi' = \varphi$, making the hyper-multiplet massless. To regularize the path integral we

¹⁸This is the dimensional reduction of a 6d $\mathcal{N} = (1, 0)$ vector multiplet. It has five real scalars.

¹⁹This is the dimensional reduction of a 6d hyper-multiplet.

need to remove the zero modes of this massless hypermultiplet from the path integral. A more detailed analysis of this hyper-multiplet theory will be given in Section 7.

The D1-D5_(α) open strings give rise to a single zero-dimensional fermion living at the intersection of the branes, with complex mass $\varphi - \varphi^{(D5)}$, associated to the distance between the D1 and the D5 along the $x^8 + ix^9$ direction²⁰ (this is similar to the D3-D3" intersection studied above). Here the D5 is at the origin $\varphi^{(D5)} = 0$, so that the 0d action is

$$S_{0d,(\alpha)} \sim \bar{\chi}_{(\alpha)} \varphi \chi_{(\alpha)}, \quad \alpha = 1, 2. \quad (4.26)$$

In addition there can be cubic interactions between the D1-D3, D3-D5 and D5-D1 open string modes. We will assume that they do not affect the integration over the zero-dimensional and one-dimensional fields.

Integrating out the 1d vector multiplet and the 0d hyper-multiplet yields a factor independent of the 3d fields, so we neglect it. Integrating out the fermion χ_α yields a factor $\varphi(P_\alpha)$, where P_α is the intersection point of the D1 and D5_(α) branes. The total insertion after integrating out the zero-dimensional fields is then

$$\varphi(P_1)\varphi(P_2) \simeq \varphi(P)^2, \quad (4.27)$$

since the points P_1 and P_2 are indistinguishable in the low-energy limit $P_1 \simeq P_2 \equiv P$.

Identifying the two “readings” of the brane setup, we obtain the relation (4.25). Here we see that no brane move was necessary to get the relation.

Finally we note that we made an implicit assumption in our analysis, which is that the presence of the D5 branes do not affect the monopole operator insertion in a configuration with a single semi-infinite D1 ending on the D3 (Figure 8-a,-b). Our analysis of the CB relation indicates that there is no effect due to these strings when the D1 is dissolved in the D3 to insert a monopole operator. On the contrary, when the D1 is flat (crossing the D3) the D1-D5 string modes play a crucial role in the operator insertion, as we discussed. One way to think about this phenomenon is that in the configuration inserting a monopole operator the D1 forms a spike ending on the D3. Then there is no distinction between D1-D5 strings and D3-D5 strings and therefore no additional light modes due to D1-D5 strings.

4.4 Mirror symmetry

Three-dimensional $\mathcal{N} = 4$ theories are subject to an infrared duality called mirror symmetry. The main statement is that pairs of mirror dual theories flow in the same (strongly coupled) infrared fixed point and that the Higgs branch of one theory is

²⁰The D1 is at the same position φ as the D3 in $x^8 + ix^9$.

identified with the infrared quantum corrected Coulomb branch of the dual theory [1]. Since the HB and CB chiral rings are independent of the RG flow, we obtain the prediction that the HB chiral ring of one theory must match the CB chiral ring of the mirror dual theory. The duality swaps the $SU(2)_C$ and $SU(2)_H$ R-symmetry actions, the infrared enhanced topological symmetry G_C and the flavor symmetry G_F , and the mass and FI deformation parameters.

The $T[SU(2)]$ theory is known to be self-dual under mirror symmetry, therefore its Higgs branch and Coulomb branch operators and ring relations should be mapped under the duality. In this simple theory, the map is easily found to be

$$\begin{aligned}\varphi &\leftrightarrow Z^2_2 (= -Z^1_1), \\ u^+ &\leftrightarrow Z^2_1, \\ u^- &\leftrightarrow Z^1_2.\end{aligned}\tag{4.28}$$

This identification maps the CB quantum relation $u^+u^- = -\varphi^2$ to the HB trivial relation $Z^2_1Z^1_2 = Z^2_2Z^1_1$.

The point of view that we develop in this paper is that the mirror map of operators can be found directly from the brane realizations. Indeed it is now well-known that mirror symmetry of the three dimensional theory follows from the action of type IIB S-duality on the brane realizations. In order to find the mirror map between operators, one can start with the brane setup realizing a local operator, then act with S-duality on the configuration and read off the mirror operator from the resulting brane setup.

The action of S-duality on the various branes involved is described in Table 3. Here we combine S-duality with the space rotation $(x^{4,5,6}, x^{7,8,9}) \rightarrow (x^{7,8,9}, -x^{4,5,6})$, so that the branes always have orientations as in Table 2.

Brane	D3	D5	NS5	F1	D1	D3'	D3''
S-dual brane	D3	NS5	D5	D1	F1	D3''	D3'

Table 3. S-duality action on branes and strings.

Let us see how this works for the $T[SU(2)]$ theory. In the absence of local operator insertion the theory is realized by the brane configuration of Figure 4. Applying S-duality, we obtain a configuration with a D3 stretched between two D5s and crossing two NS5s. We then need to move the D5s to the middle of the configurations, so that each D5 passes across an NS5. Taking into account the HW brane creation effect (see Section 3.1) we recover the initial configuration, confirming that the $T[SU(2)]$ theory is self-dual under mirror symmetry. This process is depicted in Figure 12.

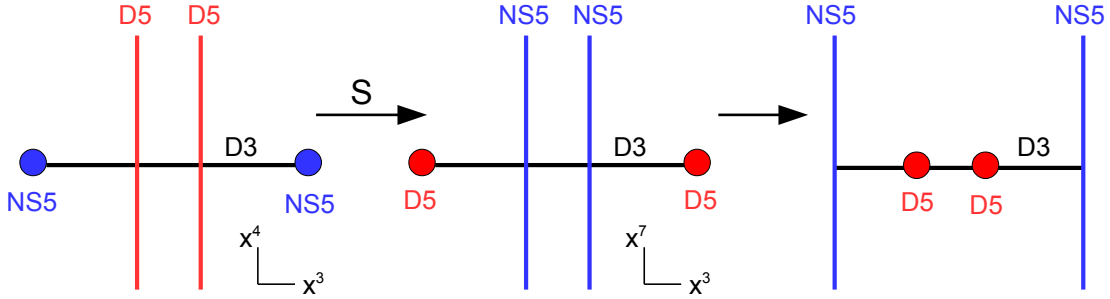

Figure 12. Brane configuration of $T[SU(2)]$. After acting with the S transformation and moving the D5s to the middle, one recovers the initial configuration.

The brane setup realizing the monopole operator u^+ is that of Figure 8-a. Acting with the S -transformation and moving the D5s to the middle, as in Figure 13-a, we directly obtain the setup realizing the meson operator Z^2_1 . Similarly starting from the setup of Figure 8-b, realizing $-u^-$, we find that the S -dual setup is that of the operator $-Z^1_2$. We therefore obtain immediately the mirror map involving the monopole operators. For the insertion of the scalar operator φ , we start with the configuration of Figure 8-c, which has a D3' brane crossing the D3. Acting with S -duality and moving the D5s we obtain the configuration of Figure 13-b, which has a D3' crossing the D3. As argued in section 4.3, this setup realizes the insertion of the meson operator Z^2_2 or equivalently $-Z^1_1$. This can be seen by moving the D3' to the right of the configuration, leading to the creation of an F1 string ending on $D5_{(2)}$ (Figure 6-b and 13-b), or to the left, leading to the creation of an F1 string ending on $D5_{(1)}$ (Figure 6-a). This reproduces the mirror map (4.28). In addition, we observe that the brane configurations with two interpretations leading to the HB and CB relations are S -dual to each other.

4.5 Deformations

To complete the analysis of the $T[SU(2)]$ theory, we discuss the complex mass and Fayet-Iliopoulos deformations.

The mass deformations are simpler to understand. In the field theory there are three real mass deformations for each hypermultiplet, transforming as a triplet of $SU(2)_C$. They can be seen as background values of scalars in vector multiplets gauging the flavor symmetries. The mass deformations lift the Higgs branch and modify the Coulomb branch geometry. For each triplet of masses, two out of the three parameters combine into a complex mass m_C ²¹. In the $T[SU(2)]$ theory there are two such complex

²¹This choice is correlated to the choice of complex structure on the Coulomb branch (see Section

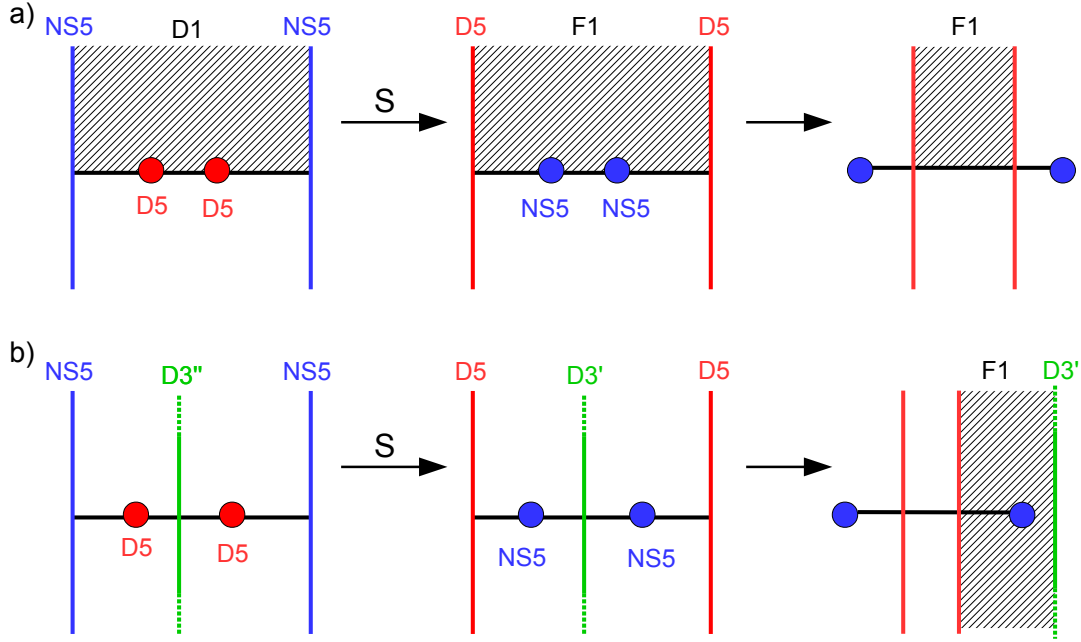

Figure 13. a) Starting from the u^+ insertion setup and applying S-duality leads the Z^2_1 insertion setup, after brane rearrangements. b) Starting from the φ insertion setup and applying S-duality leads to the Z^2_2 insertion setup, after brane rearrangements.

masses m_α , $\alpha = 1, 2$, for the two hyper-multiplets, and the CB relation becomes [12]

$$u^+ u^- = -(m_1 - \varphi)(m_2 - \varphi). \quad (4.29)$$

Simultaneous shift of complex masses by the same constant can be re-absorbed into a redefinition of the complex scalar φ , so that only the parameter $m_1 - m_2$ is physical.

In the brane setup the complex mass deformations are associated to D5 brane displacements along the x^8 and x^9 directions. Denoting $x_\alpha^{8,9}$, $\alpha = 1, 2$, the positions of the two D5s, we have $m_\alpha \equiv \varphi_\alpha^{(D5)} = x_\alpha^8 + ix_\alpha^9$. It is easy to correct the derivation of the CB relation from the brane picture. In the second interpretation of the setup of Figure (11) (see Section 4.3), considering the D1 crossing the D3, the zero-dimensional fermion χ_α living at the intersection of the D1 and $D5_{(\alpha)}$ branes now has mass $m_\alpha - \varphi$, corresponding to the distance between the D1 and the D5 in the x^8 and x^9 directions,

$$S_{0d,(\alpha)} \sim \bar{\chi}_{(\alpha)}(m_\alpha - \varphi)\chi_{(\alpha)}, \quad \alpha = 1, 2. \quad (4.30)$$

2)

Integrating out the two fermions yields the operator insertion

$$(m_1 - \varphi)(m_2 - \varphi), \quad (4.31)$$

leading to the deformed relation (4.29).

Let us turn to the FI deformations. Those lift the Coulomb branch and deform the Higgs branch. They are parametrized by three real parameters, transforming as a triplet of $SU(2)_H$. Two out of the three deformations combine into a complex FI parameter η_C which affects the F-term relations in the Higgs branch chiral ring. For the $T[SU(2)]$ theory there is a single complex FI parameter η and the HB relations are

$$\text{Tr } Z = \eta, \quad \det Z = 0. \quad (4.32)$$

In the brane picture the η deformation can be identified with displacements of the NS5s along the x^5 and x^6 directions. More precisely, denoting $x_i^{5,6}$, $i = 1, 2$, the positions of the two NS5s, we can define $\xi_i = x_i^5 + ix_i^6$ and the complex FI parameter is $\eta = \xi_1 - \xi_2$. The modified setup is depicted in Figure 14-a.

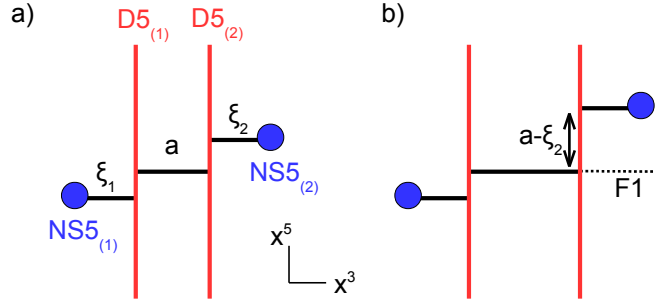

Figure 14. a) Configuration associated to the FI deformation $\eta = \xi_1 - \xi_2$ ($x^{3,5}$ plane). b) Brane setup inserting the operator $Y = Z^2_2 + \xi_2$.

The modification of the brane analysis due to NS5 displacements is not straightforward to understand, as it is often the case with NS5 brane effects. We can give a heuristic argument leading to the conclusion that the displacements affect the operator insertions, rather than the reading of the HB relations. One can imagine giving a vev to the meson operators Z^2_2 and Z^1_1 . This corresponds in the brane picture to moving the D3 segment between the two D5s along the $x^{5,6}$ directions. In the absence of FI deformations, the D3 displacement along $x^{5,6}$ to the position $a = x^5 + ix^6$ corresponds to giving vevs $\langle Z^2_2 \rangle = -\langle Z^1_1 \rangle = a$ ²², namely giving a vev a to the operator inserted

²²This follows from the analysis in [17]. It can also be seen as the mirror-dual operation of giving a

by the setups of Figure 6-a and -b. The origin of the moduli space, $a = 0$, corresponds to the D3 segment in the middle being aligned with the two external D3 segments.

Let us focus on the brane setup of Figure 14-b and let us denote Y the operator inserted by the F1 string ending on the right side of $D5_{(2)}$ and aligned with the middle D3 segment. Moving the middle D3 segment to a position a is now associated to giving a vev to the operator \mathcal{O} , $\langle Y \rangle = a$. When $a = \xi_2$, the middle D3 segment is aligned with the D3 segment stretched between $D5_{(2)}$ and $NS5_{(2)}$ (the NS5 on the left). Locally this situation is identical to the situation without FI deformation when we sit at the origin of the moduli space and must correspond to having $\langle Z^2_2 \rangle = 0$, namely a vanishing vev for the meson sourced by D3- $D5_{(2)}$ open string modes. This suggests the identification

$$Z^2_2 = Y - \xi_2 . \quad (4.33)$$

A corresponding reasoning, applied to the brane setup of Figure 6-a, with the F1 string ending on $D5_{(1)}$, which also inserts the operator Y , leads to the identification

$$-Z^1_1 = Y - \xi_1 . \quad (4.34)$$

The relations following from the brane realizations, as described in Section 4.3, with these deformed insertions are

$$Z^2_2 + \xi_2 = -Z^1_1 + \xi_1 \equiv Y , \quad -Z^2_1 Z^1_2 = -Z^2_2 Z^1_1 , \quad (4.35)$$

where the second relation is the same as before. These relations match the deformed relations (4.32).

There is an alternative and more robust way to understand these operator insertions by studying the brane configuration with a D3' brane between the two D5s, intersecting the D3 (middle figure in Figure 10), which is obtained from the above brane setup by HW moves. This setup was analyzed in Section 4.3 using the results of [17], with the operator insertion following from integrating out a 0d fermion with complex mass $-Z^1_1 = Z^2_2$. The FI deformation changes the analysis by modifying the boundary conditions on the scalar Φ to $\Phi(0) = \xi_1$ and $\Phi(L) = \xi_2$. Requiring the existence of a solution for $\Phi(x^3)$ imposes the modified F-term constraint $\xi_1 - Z^1_1 - Z^2_2 = \xi_2$, and the operator insertion is $\xi_1 - Z^1_1 = \xi_2 + Z^2_2 \equiv Y$, in agreement with our heuristic derivation.

Mirror symmetry now related the $T[SU(2)]$ theory deformed by masses, with lifted

vev a to φ by moving the D3 between the two NS5s along x^8 .⁹ Indeed φ is the mirror-dual operator to $Z^2_2 (= -Z^1_1)$ in the absence of FI deformation.

Higgs branch and deformed Coulomb branch, to a dual $T[SU(2)]$ theory deformed by FI terms, with lifted Coulomb branch and deformed Higgs branch, with the map of operators

$$\begin{aligned}\varphi &\leftrightarrow Y, \\ u^+ &\leftrightarrow Z^2_1, \\ u^- &\leftrightarrow Z^1_2.\end{aligned}\tag{4.36}$$

Note that this map is found after solving for the F-term relation on the HB side. The second Higgs branch relation becomes

$$Z^2_1 Z^1_2 = -(Y - \xi_1)(Y - \xi_2),\tag{4.37}$$

which is mapped to the CB relation, through the usual map between masses and FI parameters $(m_1, m_2) \leftrightarrow (\xi_1, \xi_2)$.

We have now completed our study of the $T[SU(2)]$ theory. We have developed most of the tools needed to analyse moduli spaces from brane realizations and we are in a position to study more sophisticated theories.

5 Abelian generalizations

In this section, we extend the analysis of the vacuum moduli spaces from brane configurations to more sophisticated abelian theories. We consider the abelian theory with N_f fundamental hyper-multiplets, or $\mathcal{N} = 4$ SQED, and its mirror dual theory, which is an abelian quiver theory. We show that the Coulomb and Higgs branch operators and the ring relations are correctly reproduced by following the brane reading rules found in the previous section and some new rules that we derive. We provide the mirror map of operators using S-duality of the brane picture. We illustrate our procedure in another couple of mirror dual theories. Applications to arbitrary abelian quivers should then be straightforward. The final dictionary between brane setups and operator insertions, as well as the mirror map between HB and CB operators, are provided in Appendix B.

5.1 SQED

We consider the $\mathcal{N} = 4$ SQED theory. It has $U(1)$ gauge group and N_f fundamental hyper-multiplets, with complex scalars $(Q^\alpha, \tilde{Q}_\alpha)$, $\alpha = 1, \dots, N_f$. The quiver diagram and the brane realization are shown in Figure 15. In particular, there are now N_f D5s crossing the D3, sourcing the hyper-multiplets. We will denote them $D5_{(\alpha)}$ with $\alpha = 1, \dots, N_f$, labeling the branes from left to right.

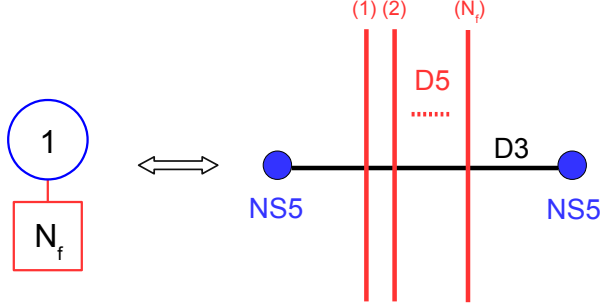

Figure 15. Quiver and brane configuration of $\mathcal{N} = 4$ SQED. There are N_f D5 branes.

5.1.1 Higgs branch

The Higgs branch of the theory is generated by the meson operators

$$Z^\alpha_\beta = \tilde{Q}_\beta Q^\alpha, \quad \alpha, \beta = 1, \dots, N_f, \quad (5.1)$$

which satisfy by definition

$$Z^\alpha_\beta Z^\gamma_\delta - Z^\alpha_\delta Z^\gamma_\beta = 0, \quad \text{for all } \alpha, \beta, \gamma, \delta, \quad (5.2)$$

and are subject to the F-term constraint:

$$\text{Tr } Z \equiv \sum_\alpha Z^\alpha_\alpha = 0. \quad (5.3)$$

The relations (5.2) can be recast as $\text{rank}(Z) \leq 1$.

It will be useful to introduce

$$Z_{[\alpha:\beta]} \equiv \sum_{\gamma=\alpha}^{\beta} Z^\gamma_\gamma. \quad (5.4)$$

The mesons Z^α_α can be traded for the operators $Z_{[1:\alpha]}$ or $Z_{[\alpha+1:N_f]}$. The mesons naturally realized in terms of brane setups are of the type $Z^{\alpha+1}_\alpha$, $Z^\alpha_{\alpha+1}$, $Z_{[1:\alpha]}$ and $Z_{[\alpha+1:N_f]}$ (no sum over α), with the following dictionary:

- The insertions of the meson operators $Z^{\alpha+1}_\alpha$ and $-Z^\alpha_{\alpha+1}$ are realized by adding a semi-infinite F1 string stretched between $D5_{(\alpha)}$ and $D5_{(\alpha+1)}$, and ending on the D3 from above and below respectively, as in Figure 16-a,b.
- The insertion of the meson operator $-Z_{[1:\alpha]}$ is realized by adding a D3' brane on

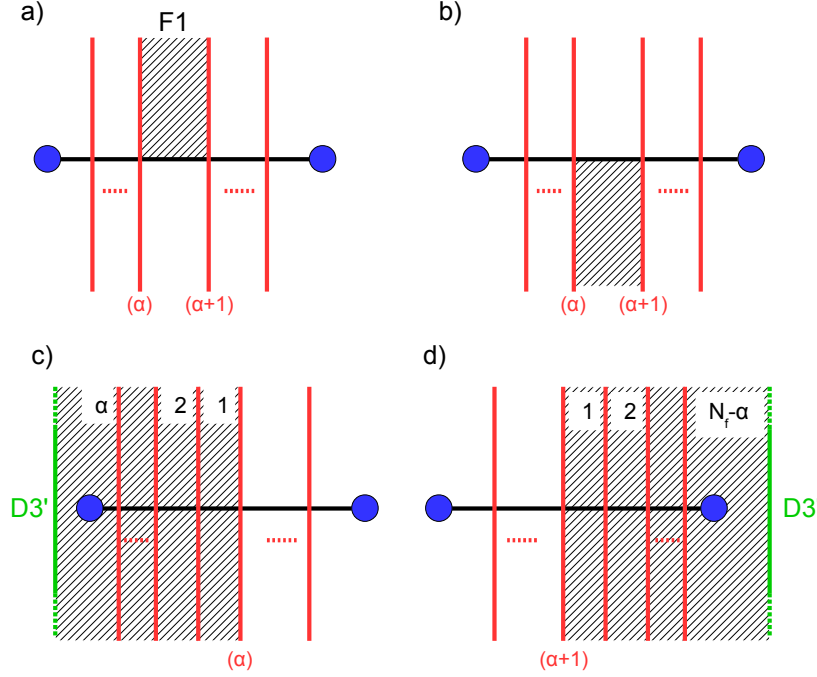

Figure 16. Brane setups inserting the operators: a) $Z^{\alpha+1}_\alpha$; b) $-Z^\alpha_{\alpha+1}$; c) $-Z_{[1:\alpha]}$; d) $Z_{[\alpha+1:N_f]}$. The integers $1, 2, \dots, \alpha$ indicate the number of superposed F1 strings in each region.

the left of the brane configuration and one F1-string stretched between the $D3'$ and $D5_{(\beta)}$, for all $\beta \in [1, \alpha]$, so that there is a total of α F1s in the setup. This is described in Figure 16-c

- The insertion of $Z_{[\alpha+1:N_f]}$ is realized by adding a $D3'$ brane on the right of the brane configuration and one F1-string stretched between the $D3'$ and $D5_{(\beta)}$, for all $\beta \in [\alpha + 1, N_f]$, so that there is a total of $N_f - \alpha$ F1s. This is described in Figure 16-d.

These brane setups are simple generalizations of the one studied in Section 4.1 for the $T[SU(2)]$ theory, which corresponds to the case $N_f = 2$.²³

One important comment about these setups is that in each case there is a single way of interpreting the configuration, namely there is a single way to describe which brane ends on which other branes. This is obvious for the setups of Figure 16-a,b. For the setups of Figure 16-c,d, this follows from the *s-rule* which imposes that there is

²³From our previous discussions, it is not obvious why the configuration 16-c (and similarly 16-d) realizes the insertion of the sum of meson operators $\sum_{\gamma=1}^{\alpha} Z^{\gamma}_{\gamma}$ and not the product of these mesons. However this turns out to be consistent with our general analysis. Moreover we will find in Section 6 different brane setups realizing the insertions of products of mesons.

at most a single F1 string stretched between a D3' and a D5. This implies that the F1 cannot break into several pieces ending on both sides of some D5. Since there is a single way of interpreting these brane setups, they must insert operators which cannot be generated by products of operators, so they must belong to a basis of the HB chiral ring.

There is however a puzzle since the operators listed above are not enough to generate the whole Higgs branch ring, namely we are missing the operators Z^α_β with $|\alpha - \beta| > 1$. We will see shortly that these operators appear in brane setups related to the HB ring relations.

Ring relations:

We observe immediately that the F-term relation (5.3) follows from considering the configuration realizing $-Z_{[1:\alpha]}$, i.e. Figure 16-c, and moving the D3' brane from the left to the right in the configuration. Taking into account Hanany-Witten F1 creation effect, we end up with the configuration of Figure 16-d, realizing the $Z_{[\alpha+1:N_f]}$ insertion. We therefore obtain the relation

$$-Z_{[1:\alpha]} = Z_{[\alpha+1:N_f]}, \quad (5.5)$$

which is nothing but $\text{Tr } Z = 0$, for any chosen α .

The other relations in the chiral ring (5.3) follow from interpreting in several ways configurations with a semi-infinite or full F1 string stretched between two D5s, presented in Figure 17-a,b,c.

The brane setup of Figure 17-a is analogous to the one studied in Section 4.3 and leads by the same reasoning to the relations

$$Z^{\alpha+1}_\alpha Z^\alpha_{\alpha+1} = Z^\alpha_\alpha Z^{\alpha+1}_{\alpha+1}, \quad (5.6)$$

for all α . These are part of the HB relations (5.2).

The setup of Figure 17-b has an F1 stretched between $D5_\alpha$ and $D5_\beta$, with $\alpha < \beta$, and ending on the D3 from above. The analysis of the meson operator insertions in Section 4.1 and the discussion of Section 4.3 leading to the “trivial” Higgs branch relation²⁴ can be adapted to the present situation. The setup of Figure 17-b can be

²⁴We refer to the Higgs branch meson relations which follow from rearrangements of the elementary hyper-multiplet scalar fields as trivial. In terms of gauge invariant operators, these relations are not trivial at all.

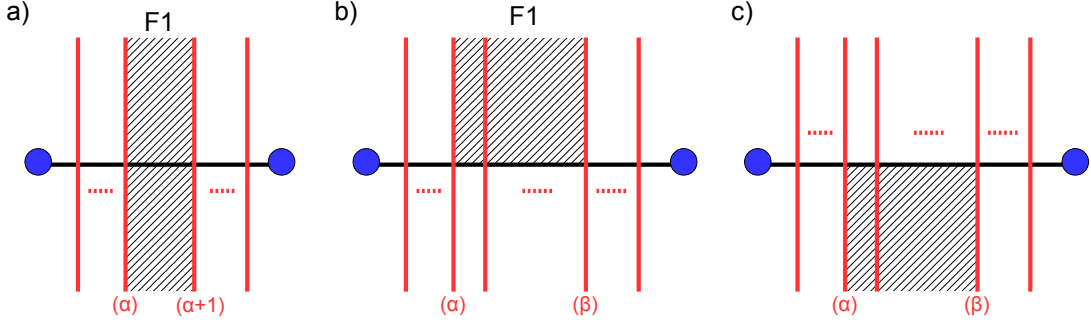

Figure 17. a) Setup realizing $-Z^\alpha_\alpha Z^{\alpha+1}_{\alpha+1}$ or $-Z^{\alpha+1}_\alpha Z^\alpha_{\alpha+1}$. b) Setup realizing $Z^\beta_\alpha \prod_{\alpha < \gamma < \beta} Z^\gamma_\gamma$. c) Setup realizing $(-)^{\alpha+\beta+1} Z^\alpha_\beta \prod_{\alpha < \gamma < \beta} Z^\gamma_\gamma$. The F1 can split along the D5s, leading to alternative interpretations of the operator insertions.

interpreted as inserting the operator

$$Z^\beta_\alpha \prod_{\alpha < \gamma < \beta} Z^\gamma_\gamma, \quad (5.7)$$

where the operator Z^β_α comes from the two F1 corners with $D5_{(\alpha)}$ and $D5_{(\beta)}$ respectively, and the operators Z^γ_γ , with $\alpha < \gamma < \beta$, come from the F1 edges crossing the $D5_{(\gamma)}$ branes. We will say that Z^β_α is the contribution of an F1 stretched between $D5_{(\alpha)}$ and $D5_{(\beta)}$, ending on the D3 from above, and that Z^γ_γ is the contribution of the D3- $D5_{(\gamma)}$ intersection with an F1 ending on the D3 from above.

Alternatively we can think of the setup as having $\beta - \alpha$ semi F1 strings, with one string stretched between $D5_{(\gamma)}$ and $D5_{(\gamma+1)}$, for $\gamma = \alpha, \dots, \beta - 1$. This corresponds to the insertion of the operator product

$$\prod_{\gamma=\alpha}^{\beta-1} Z^{\gamma+1}_\gamma. \quad (5.8)$$

We therefore get the relation

$$Z^\beta_\alpha \prod_{\alpha < \gamma < \beta} Z^\gamma_\gamma = \prod_{\gamma=\alpha}^{\beta-1} Z^{\gamma+1}_\gamma, \quad (5.9)$$

for each pair (α, β) , with $\alpha < \beta$. There are even more ways to read the setup of Figure 17-b, each corresponding to some splitting of the F1 string into several pieces ending on D5s. They lead to redundant relations.

The same considerations applied to the setup of Figure 17-c lead to the relations²⁵

$$Z^\alpha_\beta \prod_{\alpha < \gamma < \beta} Z^\gamma_\gamma = \prod_{\gamma=\alpha}^{\beta-1} Z^\gamma_{\gamma+1}, \quad (5.10)$$

for each pair (α, β) , with $\alpha < \beta$.

Together, the relations (5.6), (5.9) and (5.10) imply all the Higgs branch relations (5.2), as we show in Appendix A, up to one caveat. The caveat in the derivation of (5.2) is that at some point in the computations we need to divide by products of Z^α_α operators. This is valid only when these are non-zero, so strictly speaking we need to add this extra ingredient, or rule, to our derivation of the relations, saying that operators Z^α_α appearing on both sides of a relation can be suppressed. This means that the resulting relations remain valid even at $Z^\alpha_\alpha = 0$. To avoid confusions we will call the relations (5.6), (5.9) and (5.10) the *pre-relations*, indicating that these are not yet the full set of ring relations, except in special cases (like in the $T[SU(2)]$ theory). From the pre-relations, the ring relations are uniquely determined by considering all the relations generated by the pre-relations and suppressing Z^α_α operators appearing on both sides of a relation. In the following we will derive the pre-relations from the brane setups and match them under mirror symmetry. This is equivalent to matching the full set of ring relations.

We have thus recovered the HB relations from the brane analysis. Again the “trivial” relations follow from different readings of some brane setups, while the F-term relation follow from identifying brane setups after D3’ moves.

As for the $T[SU(2)]$ theory, the Higgs branch can be deformed by FI terms. Turning on a FI term with complex parameter η , appropriate to the chosen complex structure on the Higgs branch, the F-term relation gets deformed to

$$\text{Tr } Z = \eta. \quad (5.11)$$

The counterpart in the brane picture is as in the $T[SU(2)]$ theory: the deformation corresponds to displacements of the NS5s along the $x^{5,6}$ directions, with $\eta = \xi_1 - \xi_2$ the difference between the two brane positions. The argumentation in Section 4.5 leads in the present situation to a modification of the operator insertions for the brane setups of Figure 17-c and -d, which become $-Z_{[1:\alpha]} + \xi_1$ and $Z_{[\alpha+1:N_f]} + \xi_2$ respectively. The

²⁵In our conventions, each insertion comes with a minus sign and an overall factor $(-1)^{\alpha+\beta+1}$ drops from both sides of the relation.

relation following from moving the D3' brane across the configuration becomes

$$-Z_{[1:\alpha]} + \xi_1 = Z_{[\alpha+1:N_f]} + \xi_2 \equiv Y_\alpha, \quad (5.12)$$

reproducing the deformed F-term relation, for any α .

The dictionary between brane setups and HB operator insertions is summarized in Appendix B.

5.1.2 Coulomb branch

The Coulomb branch of $\mathcal{N} = 4$ SQED is simpler than the Higgs branch. The chiral ring is generated by the monopole operators u^\pm of monopole charge ± 1 respectively and the complex scalar φ , subject to the quantum relation ²⁶

$$u^+ u^- = - \prod_{\alpha=1}^{N_f} (m_\alpha - \varphi), \quad (5.13)$$

where we have included the complex mass deformations m_α for the N_f hyper-multiplets.

The insertions of the operators $\pm u^\pm$ and φ are realized as for the $T[SU(2)]$ theory, with the only difference that there are N_f D5s instead of two D5s. The brane setups are shown in Figure 18-a,b,c. For the insertion of the operator φ the position of the D3'' along x^3 (and with respect to the D5s) is irrelevant in the infrared limit.

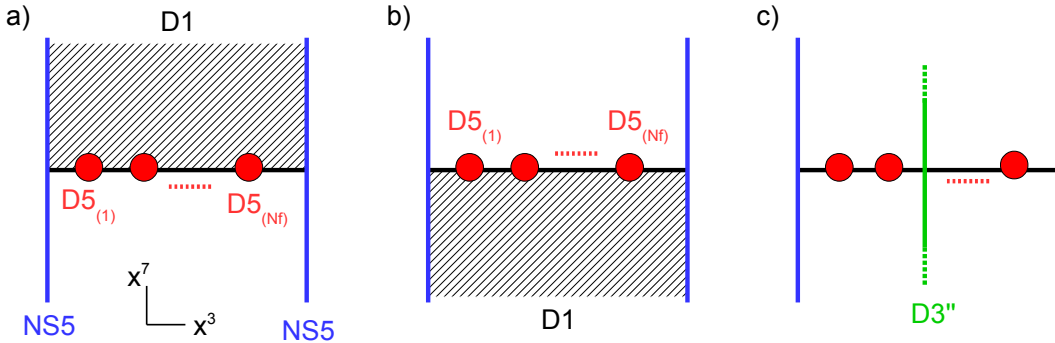

Figure 18. a) Semi infinite D1 ending on the D3 from above, inserting the monopole operator u^+ . b) Semi infinite D1 ending on the D3 from below, inserting the monopole operator $-u^-$. c) D3'' brane crossing the D3 at an arbitrary position in x^3 between the two NS5s, inserting the complex scalar operator φ .

²⁶Our conventions differ from those in [12] by reversing the sign of the complex scalars φ and complex masses m_α .

The relation (5.13) is derived from the brane setup of Figure 19, with a full D1 brane stretched between the two NS5s. This can be interpreted as inserting the product of monopole operators $-u^+u^-$, with two semi-D1s ending on the D3 from above and from below. Alternatively it can be seen as a full D1 crossing the D3, with a one-dimensional theory living on its worldvolume in the low energy limit, together with a zero dimensional hyper-multiplet sourced by the D1-D3 strings and N_f zero-dimensional fermions sourced by the D1-D5 strings. The analysis of this system was done in Section 4.3. Integrating out the 1d theory and the hyper-multiplet yields a trivial factor. Integrating out the fermions produces the product of operators

$$\prod_{\alpha=1}^{N_f} (m_\alpha - \varphi), \quad (5.14)$$

where $m_\alpha - \varphi$ is the complex mass of the fermion sourced by the D5-D1_(α) open strings and corresponds to the distance along $x^8 + ix^9$ between the D5 and the D1. Identifying the two interpretations of the same brane setup gives the CB relation (5.13).

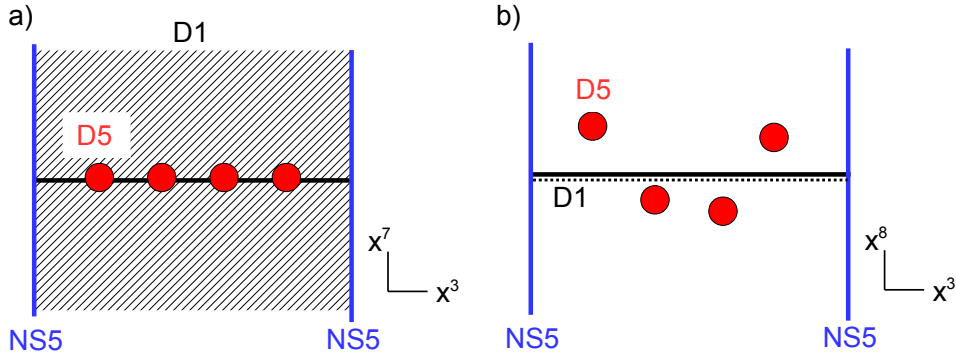

Figure 19. a) Single D1 crossing the D3 ($x^{3,7}$ plane). b) The same configuration shown in the $x^{3,8}$ plane. The D1 appears on top of the D3. The D5s positions along x^8 correspond to the (real part of the) mass parameters m_α .

Here we have obtained directly the CB relation from a brane setup. This is one of the special cases when the pre-relations – the relations read from the brane setups – directly match the full ring relations.

To check mirror symmetry we need to study the mirror theory, which is an abelian linear quiver.

5.2 Abelian Quiver

The extension to abelian quivers requires a few more efforts. We explain in detail the case of the abelian linear quiver with M nodes and one fundamental hyper-multiplet in each exterior node, which is the mirror dual theory to SQED with $M + 1$ flavor hyper-multiplets. In addition to the two fundamental hyper-multiplets, the matter content has bifundamental hyper-multiplets connecting the nodes in a linear fashion. We will call this theory T_{abel} . The quiver diagram and the brane realization of T_{abel} are shown in Figure 20. The brane configuration has two D5 branes, which we denote $D5_{(1)}$ and $D5_{(2)}$, and $M + 1$ NS5 branes, which we denote $\text{NS5}_{(i)}$ with $i = 1, \dots, M + 1$, labeling the branes from left to right.

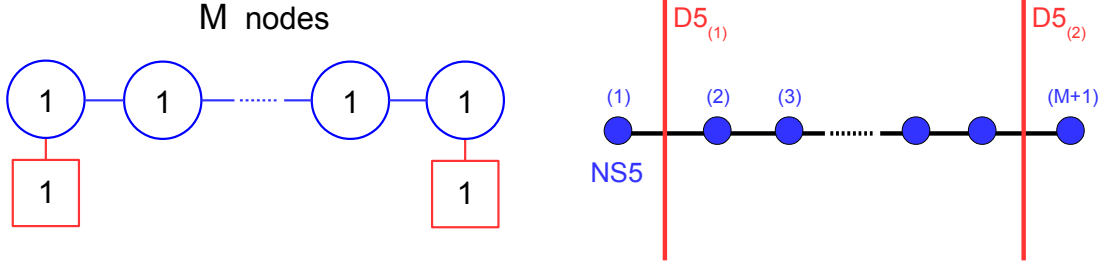

Figure 20. Quiver and brane configuration of the abelian quiver T_{abel} with M abelian nodes. There are $M + 1$ NS5 branes in the brane configuration.

5.2.1 Higgs branch

The Higgs branch of T_{abel} is parametrized by gauge invariant combinations of the fundamental hyper-multiplet complex scalars Q^1, \tilde{Q}_1 and Q^2, \tilde{Q}_2 and the bifundamental hyper-multiplet complex scalars q_i, \tilde{q}_i , $i = 2, \dots, M$ ²⁷. The HB chiral ring is generated by the $M + 1$ “short” mesons²⁸

$$\begin{aligned} X_1 &= -\tilde{Q}_1 Q^1, \\ X_i &= \tilde{q}_i q_i, \quad i = 2, \dots, M, \\ X_{M+1} &= \tilde{Q}_2 Q^2, \end{aligned} \tag{5.15}$$

²⁷The label i is chosen to start at $i = 2$, so that the scalars q_i, \tilde{q}_i are sourced by open string stretched across $\text{NS5}_{(i)}$.

²⁸We include a minus sign in the definition of X_1 , and a factor $(-1)^{M-1}$ in the definition of \tilde{W} below, for convenience.

and the two “long” mesons ²⁹

$$W = \widetilde{Q}_1 q_2 q_3 \cdots q_M Q^2, \quad \widetilde{W} = (-1)^{M-1} Q^1 \widetilde{q}_2 \widetilde{q}_3 \cdots \widetilde{q}_M \widetilde{Q}_2, \quad (5.16)$$

subject to the trivial relation

$$W \widetilde{W} = (-1)^M \prod_{i=1}^{M+1} X_i, \quad (5.17)$$

and the F-term relations

$$X_i + \widetilde{\xi}_i = X_{i+1} + \widetilde{\xi}_{i+1}, \quad i = 1, \dots, M, \quad (5.18)$$

where we have included the deformations by FI terms with complex parameter $\eta_i = \widetilde{\xi}_i - \widetilde{\xi}_{i+1}$ for the i -th abelian node.

The brane realization of the corresponding operator insertions are

- The long mesons W and $-\widetilde{W}$ are realized with a semi-infinite F1 string stretched between the two D5s and ending on the D3 segments from above and from below respectively, as in Figure 21-a,b.
- The short meson $X'_1 \equiv X_1 + \widetilde{\xi}_1$ is realized with one infinite F1 string extended on the left of the configuration and ending on D5₍₁₎, as shown in Figure 22-a. The short meson $X'_{M+1} \equiv X_{M+1} + \widetilde{\xi}_{M+1}$ is realized with one infinite F1 string extended on the right of the configuration and ending on D5₍₂₎, as shown in Figure 22-b. We can let the F1 strings end on a D3' brane away from the configuration, as in these figures.
- The short meson $X'_i \equiv X_i + \widetilde{\xi}_i$, with $2 \leq i \leq M$, is realized with a D3' brane crossing NS5_(i) as shown in Figure 22-c, with $\widetilde{\xi}_i$ the position of NS5_(i) along $x^5 + ix^6$.

To justify the brane setup realizing the long meson W , we revisit the argument of Section 4.1 for the insertion of meson operators, focusing on the part of the setup around one NS5 brane. In the region near NS5_(i), there is an F1 string ending on the two D3 segments attached to the NS5 on the left and on the right. On the two D3 worldvolumes live two abelian vector multiplets for two adjacent nodes $U(1)_{i-1} \times U(1)_i$ of the quiver. Locally we know that the F1 inserts a half-BPS Wilson loop of charge

²⁹In the notation of appendix B, we have $X_1 \equiv -Z^1_1$, $X_{M+1} \equiv Z^2_2$, $W \equiv Z^2_1$ and $\widetilde{W} \equiv Z^1_2$.

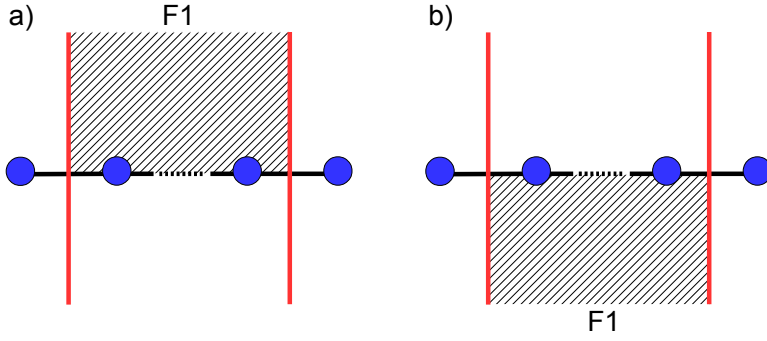

Figure 21. Brane setups of the long mesons (a) B and (b) $-\tilde{B}$.

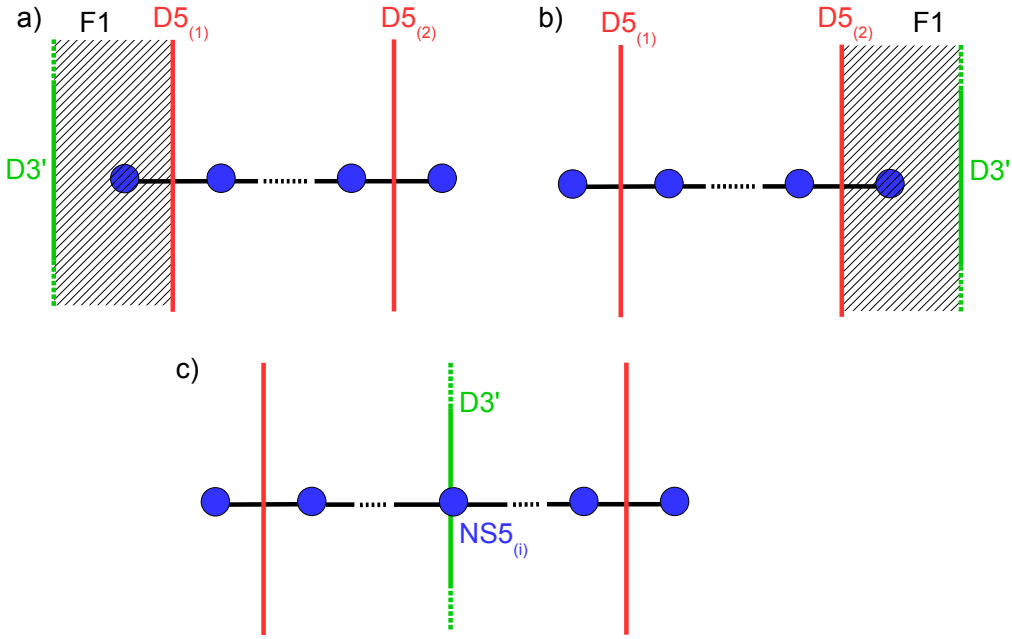

Figure 22. Brane setups of the short mesons (a) X'_1 , (b) X'_{M+1} and (c) X'_i , $2 \leq i \leq M-1$. These brane configurations are all related by $D3'$ brane moves along x^3 and are ultimately a single brane setup.

one in each node:

$$\exp\left(\int_{-\dots}^0 dx^3 (iA_3^{(i-1)} + \phi_4^{(i-1)})\right) \exp\left(\int_0^{+\dots} dx^3 (iA_3^{(i)} + \phi_4^{(i)})\right), \quad (5.19)$$

with $NS5_{(i)}$ sitting at $x^3 = 0$. This Wilson loop operator is not gauge invariant since the contours has a boundary at $x^3 = 0$. The minimal operator insertion which restores

gauge invariance is the insertion of an extra bifundamental scalar $q_i(P)$, where P is the point where the F1 meets the NS5 (in particular $x^3(P) = 0$). We propose that the full operator insertion is

$$\exp\left(\int_{-\dots}^0 dx^3 (iA_3^{(i-1)} + \phi_4^{(i-1)})\right) q_i(P) \exp\left(\int_0^{+\dots} dx^3 (iA_3^{(i)} + \phi_4^{(i)})\right). \quad (5.20)$$

Taking into account the whole brane setup and the fact that in the low energy limit, with the Neumann boundary conditions along x^3 , the Wilson loop factors trivialize, we obtain that the brane setup of Figure 21-a inserts the product of operators³⁰

$$\tilde{Q}_1 q_2 q_3 \cdots q_M Q^2 = W, \quad (5.21)$$

where the product of q_i comes from the F1-NS5s regions and the factors \tilde{Q}_1, Q^2 come from the F1-D3-D5 corners, as in previous sections. The insertion of the long meson $-\tilde{W}$ from the setup of Figure 21-b follows the same logic, with the insertion of the bifundamental scalar $-\tilde{q}_i$ from the F1 ending from below on the D3-NS5_(i) intersection. The minus sign is fixed for compatibility with the ring relations (that we derive below).

The setups corresponding to the insertion of the short mesons X'_1 and X'_{M+1} in Figure 22 have already been explained in previous sections.

The last setup, shown in Figure 22-c, is new. The D3' splits into two half-branes ending on NS5_(i). In the absence of FI deformation ($\tilde{\xi}_i = 0$), the localized open strings low modes contain the 3d bifundamental hyper-multiplet with scalars q_i, \tilde{q}_i from D3-D3 strings across NS5_(i), living on a $x^{0,1,2}$ slice, the 3d bifundamental hyper-multiplet with scalars (q', \tilde{q}') from D3'-D3' open strings across NS5_(i), living on a $x^{7,8,9}$ slice, and two zero-dimensional fermions $\chi, \tilde{\chi}$ from the D3-D3' open strings, living at the intersection point of the branes. The fermions χ and $\tilde{\chi}$ have charges $(1, 0, -1, 0)$ and $(0, 1, 0, -1)$ under the $U(1)_{i-1} \times U(1)_i \times U(1)'_{\text{up}} \times U(1)'_{\text{down}}$ 3d gauge symmetry, where $U(1)'_{\text{up}} \times U(1)'_{\text{down}}$ refers to the symmetries gauged by the two half-D3' worldvolume fields, and which can be considered as a flavor symmetry in the infrared limit³¹.

Our task is to integrate out the 0d fermions $\chi, \tilde{\chi}$. These fermions can have quartic couplings with the hypermultiplet fields. From the supersymmetry of the brane configuration we know that these couplings must preserve the same four supercharges which annihilate the scalars $q_i, \tilde{q}_i, q', \tilde{q}'$. The gauge invariant quartic coupling between

³⁰In the low energy limit all the insertion points of the scalars collapse to the same point P in the $x^{0,1,2}$ 3d space.

³¹Four-dimensional fields are frozen in the low-energy effective three-dimensional theory.

the four multiplets, compatible with this requirement³², is

$$S_{0d} \sim \bar{\chi} q_i \tilde{q}' \tilde{\chi} + \bar{\tilde{\chi}} \tilde{q}_i q \bar{\chi}. \quad (5.22)$$

There are also cubic couplings of the form $\bar{\chi} \phi \chi$ between the 0d fermions and the 4d complex scalars associated to the D3 (and D3') displacements along the directions $x^5 + ix^6$ but these scalars are set to zero by the Neumann boundary conditions on the 4d vector multiplets. Integrating out χ and $\tilde{\chi}$ leads to the insertion of the operator

$$q_i \tilde{q}_i q' \tilde{q}', \quad (5.23)$$

at the point where the D3' intersect the NS5 and the D3s. This is not yet the insertion that we proposed above. After integrating out the 0d fermions, the fields q' and \tilde{q}' are decoupled from the low-energy 3d theory living on the D3s and account only for an overall number, which we can set to one for convenience, since our analysis is not sensitive to such factors in the final operator insertions. We end up with the insertion of the operator $\tilde{q}_i q_i = X_i$, as predicted in the absence of FI deformation.

The complex FI deformations are associated to the displacement of the NS5 branes along the direction $x^5 + ix^6$. The displacement of NS5_(i) to the position $\tilde{\xi}_i$ is associated to a reconnection of the D3_(i-1) and D3_(i) branes. It is not obvious what is the corresponding deformation in terms of 0d couplings. One way to understand the effect of this deformation is to look at the brane setup inserting the meson X'_{M+1} (Figure 22-b). Moving D5₍₂₎ to the right of NS5_(M+1), with D3 creation effect, and moving the D3' brane on top of NS5_(M+1) lead to a configuration identical to those inserting the X_i operators (a D3 and a D3' crossing an NS5). Indeed, in the absence of deformations, the operator inserted is $X_{M+1} = \tilde{Q}_2 Q^2$, where (Q^2, \tilde{Q}_2) are seen as bifundamentals of the $U(1)_M^{\text{gauge}} \times U(1)_{M+1}^{\text{flavor}}$ symmetry, in agreement with the above analysis. In the FI deformed theory, with NS5_(M+1) at the position $\tilde{\xi}_{M+1}$, we have argued that the operator inserted is $X'_{M+1} = X_{M+1} + \tilde{\xi}_{M+1}$. We deduce that the operator inserted is by the D3'-D3-NS5_(i) intersection in the FI deformed theory is

$$X'_i \equiv X_i + \tilde{\xi}_i. \quad (5.24)$$

We could have derived this operator insertion solely from the knowledge of the X'_{M+1} brane setup. The fact that we could understand it directly from the D3'-D3-NS5 intersection, in the absence of deformation, strengthen our conclusions. Knowing the

³²We remind the reader that the fermions $\chi, \tilde{\chi}$ are invariant under preserved supersymmetry transformations, as are the complex scalars $q_i, \tilde{q}_i, q', \tilde{q}'$.

final operator insertion, we can deduce that the FI deformation corresponds in the 0d theory to giving masses $\pm\sqrt{\tilde{\xi}_i}$ to the two fermions,

$$S_{0d} \sim \sqrt{\tilde{\xi}_i}(\bar{\chi}\chi - \bar{\tilde{\chi}}\tilde{\chi}) + \bar{\chi}q_i\tilde{q}'\tilde{\chi} + \bar{\tilde{\chi}}\tilde{q}'_iq\bar{\chi}. \quad (5.25)$$

Integrating out the fermions produces the insertion $\tilde{\xi}_i + q_i\tilde{q}'_iq'\tilde{q}' \sim \tilde{\xi}_i + X_i$.

Ring relations:

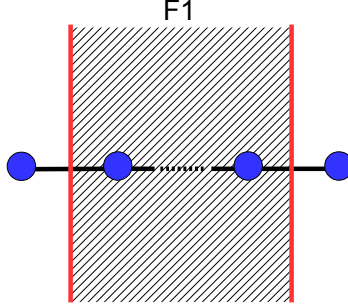

Figure 23. A full F1 stretched between the two D5s and crossing the D3 segments, realizing $-W\tilde{W}$ or $(-1)^{M+1}X_1X_2\cdots X_MX_{M+1}$.

The trivial ring relation (5.17) follows from considering the configuration of Figure 23, corresponding to the insertion of the product of long mesons $-W\tilde{W}$ and reading it in an alternative way as a product of mesons $-X_1$ and $-X_{M+1}$, from the F1 string ending on $D5_{(1)}$ and $D5_{(2)}$ respectively, and of the mesons $-X_i$, for $i = 2, \dots, M$, from the full F1 string crossing each $D3\text{-}NS5_{(i)}$ intersection. This latter configuration is seen as the product of an F1 ending on the $D3\text{-}NS5_{(i)}$ intersection from above, inserting q_i and an F1 ending on the $D3\text{-}NS5_{(i)}$ intersection from below, inserting $-\tilde{q}_i$. The complete insertion is thus $\prod_{i=1}^{M+1}(-X_i)$ and the ring relation following from the two different readings is precisely (5.17).

It is not obvious, although it must be true, from the brane setup that the complex FI deformations do not affect this relation, namely that NS5s movements do not affect how we read the operator insertions.

The F-term relations (5.18) follow from the $D3'$ brane move from the left to the right of the quiver, connecting the brane setup inserting X'_1 (Figure 22-a) to those inserting X'_i , for each i , (Figure 22-c) and the brane setup inserting X'_{M+1} (Figure 22-b). There is therefore truly only a single brane setup for all these operators inserting the operator $Y = X_i + \tilde{\xi}_i$, for any $i = 1, \dots, M+1$, solving for the F-term constraints.³³

³³It is also possible to analyse the related brane setups when the $D3'$ brane intersect a $D3_{(i)}$ segment

5.2.2 Coulomb branch

The description of the Coulomb branch of the T_{abel} theory can be found in [12]. As a hyper-Kähler manifold the Coulomb branch admits a triplet of symplectic forms. The complex structure that is chosen to describe the Coulomb branch corresponds to a certain symplectic form, from which a Poisson bracket can be defined. As a Poisson algebra, the Coulomb branch is generated by the monopole operators with charge ± 1 under a single node, u_i^\pm , for $i = 1, \dots, M$, and the complex scalars of the $U(1)$ vector multiplet φ_i , for $i = 1, \dots, M$.

As a simple ring, additional monopole operators are needed to generate the Coulomb branch. Those are monopoles with the same charge $+1$ or -1 in sequences of adjacent nodes, namely the operators $V_{[i:j]}^\pm$ with charges $+1$ and -1 respectively under each $U(1)_k$ with $i \leq k \leq j$ and zero charge under the other nodes. In the Poisson algebra description, these operators are generated by successive Poisson brackets of monopole operators, starting with $V_{[i:i]}^\pm = u_i^\pm$.

The ring relations, as derived in [12], are

$$V_A V_B = V_{A+B} P_{A,B}(\varphi_i), \quad (5.26)$$

with V_A the monopole operator of charge $A \in \mathbb{Z}^M$ under $U(1)^M$ and $P_{A,B}(\varphi_i)$ a certain polynomial of the φ_i , depending on the charges A, B , which is defined in Equation (3.13) of [12]. For most choices of charges (A, B) the polynomial P is trivial (equal to one) and the above relation can be used to eliminate the monopole V_{A+B} from the description of the chiral ring. Ultimately the Coulomb branch can be described in terms of the monopole operators $V_{[i:j]}^\pm$, $i \leq j$, and the scalars φ_i with the following relations

$$\begin{aligned} V_{[i:j]}^\pm V_{[j+1,k]}^\pm &= V_{[i:k]}^\pm (\varphi_j - \varphi_{j+1}), \\ V_{[i:j]}^+ V_{[i,k]}^- &= \begin{cases} V_{[j+1:k]}^- (\varphi_{i-1} - \varphi_i), & \text{for } j < k, \\ V_{[k+1:j]}^+ (\varphi_{i-1} - \varphi_i), & \text{for } k < j, \end{cases} \\ V_{[i:j]}^+ V_{[k,j]}^- &= \begin{cases} V_{[i:k-1]}^+ (\varphi_j - \varphi_{j+1}), & \text{for } i < k, \\ V_{[k:i-1]}^- (\varphi_j - \varphi_{j+1}), & \text{for } k < i, \end{cases} \\ V_{[i:j]}^+ V_{[i,j]}^- &= (\varphi_{i-1} - \varphi_i)(\varphi_j - \varphi_{j+1}). \end{aligned} \quad (5.27)$$

with $\varphi_0 \equiv \tilde{m}_1$ and $\varphi_{M+1} \equiv \tilde{m}_2$, the complex masses of the fundamental hyper-multiplets of the $U(1)_1$ and $U(1)_M$ nodes respectively. In the following it will be useful to consider

away from the NS5s. Integrating out the zero-dimensional fermion living at the intersection then produces the expected meson operator insertion, using the analysis in [17] of the 4d SYM theory on the D3 segments (see Section 4.3).

a subset of the ring relations, which we call *pre-relations*:

$$u_i^+ u_i^- = (\varphi_{i-1} - \varphi_i)(\varphi_i - \varphi_{i+1}), \quad i = 1, \dots, M, \quad (5.28)$$

$$\prod_{k=i}^j u_k^\pm = V_{[i:j]}^\pm \prod_{k=i+1}^j (\varphi_{k-1} - \varphi_k), \quad 1 \leq i < j \leq M, \quad (5.29)$$

where $u_i^\pm = V_{[i:i]}^\pm$. From the pre-relations (5.28), (5.29), one can generate the complete set of CB relations described above by manipulating them and allowing to suppress factors of $(\varphi_{i-1} - \varphi_i)$ which appear on both sides of a relation. This is the same procedure as described in Appendix A for the SQED Higgs branch relations, and, not surprisingly, we will show that the T_{abel} Coulomb branch pre-relations are mapped to the SQED Higgs branch pre-relations under mirror symmetry.

In the dual brane description we find that only the generators of the Poisson algebra u_i^\pm and φ_i are naturally realized:

- The insertion of the monopole operators u_i^+ and $-u_i^-$, which have charge 1 and -1 respectively under $U(1)_i$ and zero under the other $U(1)$ s, are realized by adding a semi-infinite D1 stretched between $\text{NS5}_{(i)}$ and $\text{NS5}_{(i+1)}$ and ending on the $\text{D3}_{(i)}$ segment (the segment stretched between the two NS5s) from above and from below respectively. The setups are shown in Figure 24-a and -b.
- The insertion of the scalar operator φ_i is realized by adding a D3" brane intersecting the $\text{D3}_{(i)}$ segment, which support the $U(1)_{(i)}$ vector multiplet, at a point, as in Figure 24-c.

These operator insertions are immediate generalizations of the analysis of Section 4.2.

The other operators needed to generate of the Coulomb branch as a ring, namely the operators $V_{[i:j]}^\pm$, with $i < j$, will appear from brane setups associated to the CB relations.

Ring relations

The ring relations are derived by considering the brane setups of Figure 25. To obtain the relation (5.28), we consider the setup of Figure 25-a. Seen as two semi-infinite D1 branes ending on the $\text{D3}_{(i)}$ segment from above and from below, it corresponds to the insertion of the product of fundamental monopole operators $-u_i^+ u_i^-$. Regarding it as a single D1 brane crossing the D3 segment instead, we can integrate out the 1d fields living on the D1 and the 0d fields sourced by the D1- $\text{D3}_{(k)}$, for $k \in \{i-1, i, i+1\}$, open string lowest modes. This configuration is actually very close to the one of Figure 19

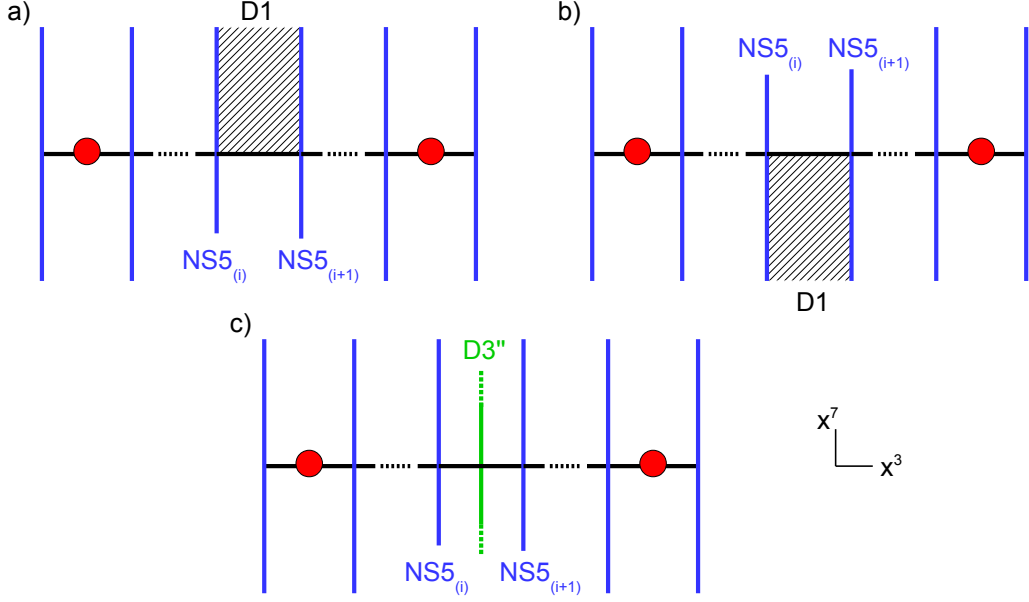

Figure 24. Brane setups realizing the insertion of the CB operators: a) u_i^+ , b) $-u_i^-$, c) φ_i .

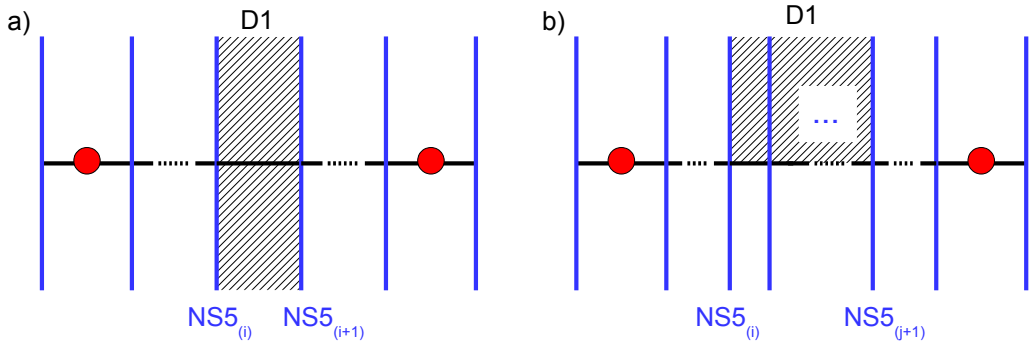

Figure 25. The CB ring relations are derived from the configurations: (a) with a D1 stretched between two adjacent NS5s, realizing $-u_i^+ u_i^-$ or $(\varphi_{i-1} - \varphi_i)(\varphi_{i+1} - \varphi_i)$, and (b) with a semi D1 stretched between two distant NS5s, ending on the D3 segments from above, realizing $\prod_{k=i}^j u_k^+$ or $V_{[i:j]}^+ \prod_{k=i+1}^j (\varphi_{k-1} - \varphi_k)$.

studied in Section 5.1.2. The only differences are the presence of D3 segments on both sides of the NS5s and the absence of D5s. However the configuration with D5s is related to the configuration with external D3 segments by HW brane moves. Starting with the setup of Figure 26-a with a D3 segment attached to the right of $NS5_{(i+1)}$, we can let the segment end on a D5 (Figure 26-b) and move the D5 between $NS5_{(i)}$ and $NS5_{(i+1)}$ (Figure 26-c). According to the analysis of Section 5.1.2 the final configuration realizes

the insertion of the local operator $m - \varphi_i = \varphi_{i+1} - \varphi_i$, where $m \equiv \varphi_{i+1}$ is the mass of the hyper-multiplet sourced by the $D3_{(i)}$ -D5 strings, or the $D3_{(i)}$ - $D3_{(i+1)}$ strings in the original setup (corresponding to the position of $D3_{(i+1)}$ along $x^8 + ix^9$). The

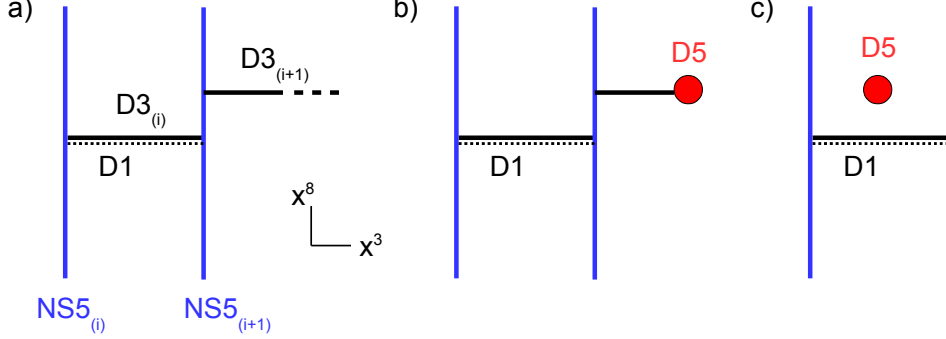

Figure 26. The local setup (a) with an external D3 segment is related to the setup (c) with a D5 brane by letting the D3 segment end on a D5 (b) and moving it between the two NS5s. The distance between the D5 and the D3 along $x^8 + ix^9$ is $\varphi_{i+1} - \varphi_i$.

operator insertion corresponding to the brane setup of Figure 25-a, seen as a single D1 crossing the $D3_{(i)}$ segment, is therefore the product $(\varphi_{i-1} - \varphi_i)(\varphi_{i+1} - \varphi_i)$ coming from integrating out the $D3_{(i-1)}$ - $D3_{(i)}$ and $D3_{(i)}$ - $D3_{(i+1)}$ modes. We obtain the CB relation (5.28).

The brane setup of figure 25-b is less straightforward to analyse. It can be seen as $j - i + 1$ semi-infinite D1s extended between neighboring NS5s, inserting the product of monopole operators $\prod_{k=i}^j u_k^+$. A second way to look at the same setup is to see it as a single semi-infinite D1 brane stretched between $NS5_{(i)}$ and $NS5_{(j+1)}$, ending on the D3 segments from above. The "single" D1 ending on the $D3_{(i)}$ to $D3_{(j)}$ segments corresponds to the insertion of the monopole operator $V_{[i,j]}^+$, which has monopole charge +1 in each $U(1)_k$ node from $k = i$ to j . In addition there are contributions from the D3-NS5 intersections with a D1 ending on the D3 from above (and crossing the NS5), whose stringy origin is unclear. This local setup is S-dual to the D3-D5 intersection with an F1 ending on the D3 from above (and crossing the D5), which inserts the same operator as the D3-D5 intersection with an F1 ending on the D5 from the right (and crossing the D3). Therefore, S-duality predicts that the D3-NS5 intersection with a D1 ending on the D3 from above (and crossing the NS5) inserts the same operator as the D3-NS5 intersection with a D1 ending on the NS5 from the right (and crossing the D3), which is the local setup we analyzed in the previous paragraph. The operator insertion is then $(\varphi_{i-1} - \varphi_i)$ for the D3- $NS5_{(i)}$ intersection. The rules for such operator insertions are summarized in Appendix B. The contributions of the $j - i$

intersections, together with the monopole operator insertion, yield in total the insertion of the operator $V_{[i:j]}^+ \prod_{k=i+1}^j (\varphi_{k-1} - \varphi_k)$. Identifying the two readings of the same brane setup we obtain the second set of relations (5.29).

The other ways to interpret the setup of Figure 25-b, splitting into various numbers of D1 pieces, lead to redundant relations.

The CB relations (5.29) involving monopole operators with negative charges are obtained from the same brane setup as in Figure 25-b, but with the semi D1 ending on the D3 segments from below. The two interpretations of the setup lead to the insertions of the operators $\prod_{k=i}^j (-u_k^-)$ and $(-V_{[i:j]}^-) \prod_{k=i+1}^j (\varphi_k - \varphi_{k-1})$ respectively, leading to the CB relations. Here again the negative charge monopole insertions come with a minus sign and $(\varphi_k - \varphi_{k-1})$ is the contribution from the D3-NS5_(k) intersection with a D1 ending on the D3 from below, which is the same as the contribution from the D3-NS5_(k) intersection with a D1 ending on the NS5 from the left, studied before.

5.3 Mirror Symmetry

The SQED and T_{abel} theories are related by mirror symmetry with the identification $N_f = M + 1$, relating the number of SQED fundamental hyper-multiplets to the number of nodes of T_{abel} . The Coulomb branch of one theory should match the Higgs branch of the other. It is possible to find the mirror map of operators using the knowledge of the ring relations, but this is not completely straightforward. Instead, as we advocate in this paper, we can simply let the action of S-duality on the brane setups give us the answer.

In the absence of operator insertions, the two dual theories are realized by the brane setups of Figure 15 and 20, which are related by the action of type IIB S-duality, followed by the exchange of the external pairs of D5 and NS5, on the left and on the right of the brane configuration. The exchanges of 5-branes induce HW D3 brane creation effects, as explained in Section 3.1. In the presence of extra strings or/and branes inserting local operators, the identification of the brane setups proceeds in the same way, by acting with S-duality and exchanging the external D5-NS5 pairs.

The SQED HB operators realized by the setups of Figure 16-a,b are mapped to the T_{abel} CB monopole operators realized by the S-dual setups of Figure 24-a,b,

$$Z^{i+1}_i|_{\text{SQED}} \leftrightarrow u_i^+|_{T_{\text{abel}}}, \quad Z^i_{i+1}|_{\text{SQED}} \leftrightarrow u_i^-|_{T_{\text{abel}}}. \quad (5.30)$$

The SQED HB operators realized by the setup of Figure 16-c,d are mapped to the T_{abel} Coulomb branch scalar operators realized setups of Figure 24-c, by S-duality and

Hanany-Witten D3" move,

$$Y_i \equiv Z_{[i+1:M+1]} + \xi_2 (= -Z_{[1:i]} + \xi_1) \Big|_{\text{SQED}} \leftrightarrow \varphi_i \Big|_{T_{\text{abel}}}, \quad i = 1, \dots, M, \quad (5.31)$$

where we have included the FI deformation in the SQED theory. This provides the mirror map for operators generating the Higgs/Coulomb branches as Poisson algebras.

To obtain the mirror map for all the operators appearing in a basis of the chiral rings, we must consider the brane setups related to the ring relations and identify the various contributions to the operator insertions across S-duality. The setup of Figure 17-a is mapped to the setup of Figure 25-a under S-duality. It implies the mapping of the ring relations (5.6) and (5.28)

$$Z^{i+1}_i Z^i_{i+1} = Z^i_i Z^{i+1}_{i+1} \leftrightarrow u_i^+ u_i^- = (\varphi_{i-1} - \varphi_i)(\varphi_i - \varphi_{i+1}), \quad (5.32)$$

and the identification of the different contributions to the operator insertions leads to (5.30) and

$$Z^i_i \Big|_{\text{SQED}} \leftrightarrow \varphi_{i-1} - \varphi_i \Big|_{T_{\text{abel}}} \quad \text{for } i = 1, \dots, M+1, \quad (5.33)$$

with $\varphi_0 \equiv \tilde{m}_1$ and $\varphi_{M+1} = \tilde{m}_2$, the mass parameters of the T_{abel} theory. These latter identifications are equivalent to (5.31), upon mapping the deformation parameters with

$$(\xi_1, \xi_2) \Big|_{\text{SQED}} \leftrightarrow (\tilde{m}_1, \tilde{m}_2) \Big|_{T_{\text{abel}}}. \quad (5.34)$$

The operator mapping (5.33) follows from identifying the contribution of a D3-D5 intersection with an F1 string ending on the D5, with the contribution of a D3-NS5 intersection with a D1 string ending on the NS5 (in the mirror theory).

The setup of Figure 17-b is mapped to the setup of Figure 25-b under S-duality. It implies the mapping of the ring relations (5.9) and (5.29) (with positive charge monopoles)

$$\prod_{k=i}^j Z^{k+1}_k = Z^{j+1}_i \prod_{k=i+1}^j Z^k_k \leftrightarrow \prod_{k=i}^j u_k^+ = V_{[i:j]}^+ \prod_{k=i+1}^j (\varphi_{k-1} - \varphi_k), \quad (5.35)$$

and the identification of operator insertions yields, in addition to (5.33), the mirror map

$$Z^{j+1}_i \Big|_{\text{SQED}} \leftrightarrow V_{[i:j]}^+ \Big|_{T_{\text{abel}}}, \quad \text{for } 1 \leq i \leq j \leq M. \quad (5.36)$$

Similarly the setup of Figure 17-c is mapped to a setup identical to Figure 25-b but with the D1 branes ending on the D3 from below, implying the map of the ring relation

(5.10) and (5.29) (with negative charge monopoles) and the identification

$$Z^i_{j+1} \Big|_{\text{SQED}} \leftrightarrow V^-_{[i:j]} \Big|_{T_{\text{abel}}}, \quad \text{for } 1 \leq i \leq j \leq M. \quad (5.37)$$

The operator map is summarized in Table 4.

It remains to compare the Coulomb branch of SQED and the Higgs branch of T_{abel} . The setups of Figure 18-a,b inserting the SQED monopole operators are mapped to the setups of Figure 21-a,b inserting the long mesons, providing the map

$$u^+ \Big|_{\text{SQED}} \leftrightarrow W \Big|_{T_{\text{abel}}}, \quad u^- \Big|_{\text{SQED}} \leftrightarrow \widetilde{W} \Big|_{T_{\text{abel}}}. \quad (5.38)$$

The setup of Figure 18-c inserting the SQED scalar operator is mapped to the setups of Figure 22, which are all equivalent, being related by D3' move along x^3 , giving the map

$$\varphi \Big|_{\text{SQED}} \leftrightarrow Y \Big|_{T_{\text{abel}}}, \quad (5.39)$$

with $Y \equiv X'_i \equiv X_i + \widetilde{\xi}_i$, for any $i \in [1, M + 1]$. We illustrate these last two S-duality maps of brane setups in Figure 27.

Finally the brane setups of Figure 19 and 23 are mapped under S-duality and correspond to the identification of the SQED CB relation (5.13) and T_{abel} HB relation (5.17),

$$u^+ u^- = - \prod_{i=1}^{M+1} (m_i - \varphi) \leftrightarrow W \widetilde{W} = - \prod_{i=1}^{M+1} (\widetilde{\xi}_i - Y), \quad (5.40)$$

provided we identify the FI and mass parameters as

$$m_i \Big|_{\text{SQED}} \leftrightarrow \widetilde{\xi}_i \Big|_{T_{\text{abel}}}, \quad i = 1, \dots, M + 1. \quad (5.41)$$

The operator and parameter maps are summarized in Table 4.

5.4 Another example

We have worked out all the rules for the insertions of chiral operators, the derivation of the ring relations on the Higgs and Coulomb branches, and the mirror map between operators in abelian quiver theories. In this section we illustrate our method on one more example, extracting the results from the brane setups, without any computation, simply by applying the rules justified in the previous sections (and summarized in Appendix B).

Consider as theory A, or T_A , a linear quiver with two abelian nodes, with one fundamental hyper-multiplet of mass m_1 in the first node and three fundamental hyper-

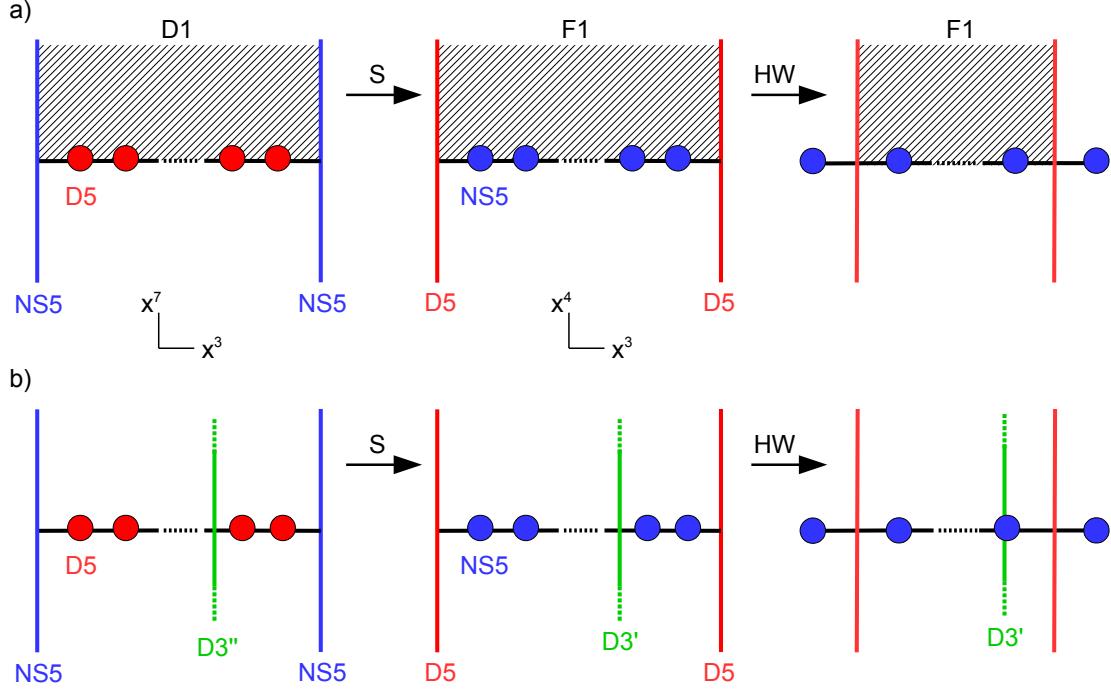

Figure 27. a) From the brane setup realizing the SQED monopole operator u^+ to the setup realizing the insertion of the long meson W in T_{abel} . b) From the brane setup realizing the SQED scalar operator φ to the setup realizing the insertion of the meson $Y (= X'_i)$ in T_{abel} . The letters S and HW denote the action of S-duality and Hanany-Witten brane moves respectively.

SQED HB	T_{abel} CB	SQED CB	T_{abel} CB
$Z^i_i \quad (i = 1, \dots, M+1)$	$\varphi_{i-1} - \varphi_i$	u^+	W
$Z^{j+1}_i \quad (i \leq j)$	$V^+_{[i:j]}$	u^-	\widetilde{W}
$Z^i_{j+1} \quad (i \leq j)$	$V^-_{[i:j]}$	φ	Y

SQED parameters	T_{abel} parameters
ξ_1, ξ_2	$\widetilde{m}_1, \widetilde{m}_2$
$m_i \quad (i = 1, \dots, M+1)$	$\widetilde{\xi}_i$

Table 4. Mirror map of HB operators and CB operators between the SQED and T_{abel} theories, and mirror map of FI and mass parameters, with $\varphi_0 \equiv \widetilde{m}_1$ and $\varphi_{M+1} \equiv \widetilde{m}_2$.

multiplets of masses m_2, m_3 and m_4 in the second node. The FI parameters are $\xi_1 - \xi_2$ and $\xi_2 - \xi_3$. The mirror dual theory is theory B, or T_B , with three nodes, with two fundamental hyper-multiplets of masses $\widetilde{m}_1, \widetilde{m}_2$ in the first node and one fundamental

hyper-multiplet of mass \tilde{m}_3 in the third node. The FI parameters are $\tilde{\xi}_i - \tilde{\xi}_{i+1}$, for $i = 1, 2, 3$.

The quiver diagrams and the type IIB brane configurations realizing these quiver theories are depicted in Figure 28. The D5 and NS5 branes are labeled $D5_{(\alpha)}$ and $NS5_{(i)}$, with α, i increasing from left to right. The brane configurations are related by S-duality and HW 5-brane moves, exchanging the external pairs of NS5 and D5 branes.

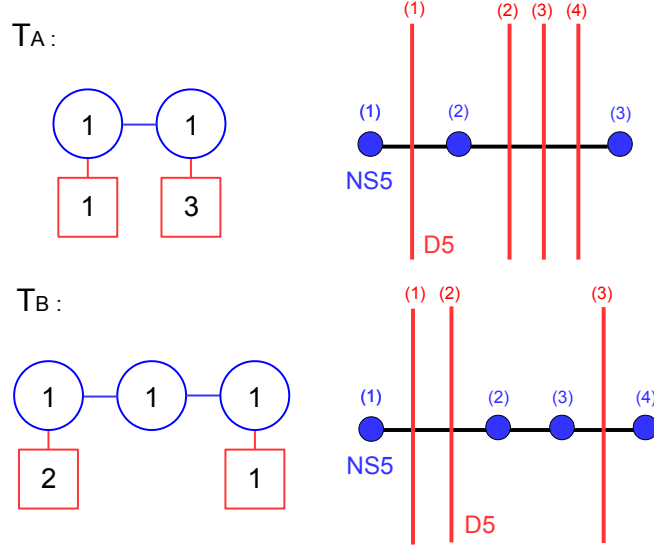

Figure 28. Quiver diagrams and brane configurations of the mirror dual theories T_A and T_B .

In the following we analyse the Higgs branch of T_A , the Coulomb branch of T_B and the mirror map between them. The analysis of the Coulomb branch of T_A and the Higgs branch of T_B is left as an exercise. The FI term deformations ξ_1, ξ_2, ξ_3 in theory A will be turned on, and the masses set to zero, while the masses $\tilde{m}_1, \tilde{m}_2, \tilde{m}_3$ in theory B will be turned on, with FI parameters set to zero. To make contact with the gauge theory language we denote by $(Q^\alpha, \tilde{Q}_\alpha)$, $\alpha = 1, \dots, 4$, the fundamental hyper-multiplet scalar and (q, \tilde{q}) the bi-fundamental hyper-multiplet scalars of the T_A theory. We also denote by $V_{[i;j]}^\pm$, $1 \leq i \leq j \leq 3$, the monopole operators of charge ± 1 in the nodes $U(1)_k$, $i \leq k \leq j$, and φ_i , $i = 1, 2, 3$, the vector multiplet complex scalars for the three nodes of the T_B theory.

The operators generating the Higgs branch of T_A are of two kinds:

- For each pair of D5 branes, $D5_{(\alpha)}-D5_{(\beta)}$, with $1 \leq \alpha < \beta \leq 4$, there is a couple of operators $(Z^{\alpha_\beta}, Z^{\beta_\alpha})$. The operator Z^{α_β} is associated to the contribution from

a semi F1 string stretched between $D5_{(\alpha)}$ and $D5_{(\beta)}$, ending on the D3 segment from above. The operator $-Z^\beta_\alpha$ is associated to the contribution from a semi F1 string stretched between $D5_{(\alpha)}$ and $D5_{(\beta)}$, ending on the D3 segment from below. Figure 29-a presents the setup inserting the operator Z^2_1 .³⁴ In the gauge theory language they are meson operators $Z^\alpha_\beta = Q^\alpha \tilde{Q}_\beta$ and $Z^\beta_\alpha = \tilde{Q}_\alpha Q^\beta$, for $2 \leq \alpha < \beta \leq 4$, and $Z^1_\beta = -Q^1 \tilde{q} \tilde{Q}_\beta$ and $Z^\beta_1 = \tilde{Q}_1 q Q^\beta$, for $2 \leq \beta \leq 4$.

- For each pair of adjacent D5, $D5_{(\alpha)}$ - $D5_{(\alpha+1)}$ with $\alpha = 1, 2, 3$, there is an operator Y_α , whose insertion is achieved by adding a D3' brane between $D5_{(\alpha)}$ $D5_{(\alpha+1)}$ and crossing the D3 segment stretched between them. By moving the D3' brane along x^3 , taking care of the F1 creation effects, we obtain various brane setups inserting the same operator Y_α . Figure 29-b presents the setup inserting the operator Y_3 . In the gauge theory language the operator Y_α corresponds to several combinations of meson operators, which are equal by the F-term constraints:

$$Y_\alpha = \xi_3 + \sum_{\beta=\alpha+1}^4 Q^\beta \tilde{Q}_\beta = \xi_2 + q\tilde{q} - \sum_{\beta=2}^{\alpha} Q^\beta \tilde{Q}_\beta = \xi_1 - \sum_{\beta=1}^{\alpha} Q^\beta \tilde{Q}_\beta, \quad (5.42)$$

with $\alpha = 1, 2, 3$. The first expression for Y_α follows from moving the D3' to the right of the configuration and reading the operator insertion, the second expression is obtained by moving the D3' on top of $NS5_{(2)}$, and the third expression is obtained by moving the D3' to the left of the configuration. The operators Y_α are related to the standard meson operators $X = q\tilde{q}$ and $Z^\alpha_\alpha = Q^\alpha \tilde{Q}_\alpha$ by the equations (5.42), which can be recast as

$$X = Y_1 - \xi_2, \quad Z^\alpha_\alpha = Y_{\alpha-1} - Y_\alpha, \quad \alpha = 1, 2, 3, 4, \quad (5.43)$$

with $Y_0 \equiv \xi_1$ and $Y_4 = \xi_3$.

There are in total six operators Z and three operators Y , so nine HB generators, after the F-term constraints have been imposed (this is already implemented in the brane setups).

To read the HB relations constraining them, we consider two kinds of brane configurations. The first set of configurations have a full F1 stretched between two consecutive D5s, $D5_{(\alpha)}$ - $D5_{(\alpha+1)}$, as in Figure 29-c for $\alpha = 1$. Looking at these configurations as two

³⁴As explained in previous sections, there is no setup inserting the operators Z^α_β , with $|\alpha - \beta| \geq 2$, alone.

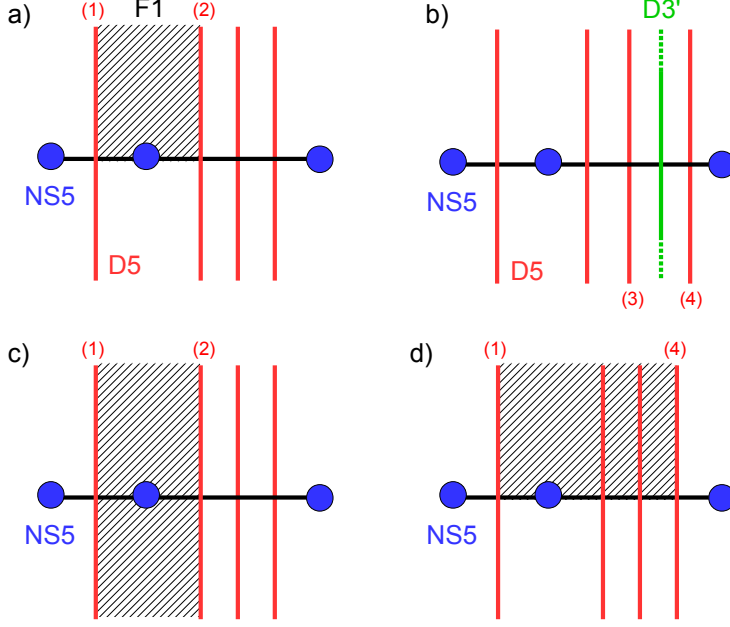

Figure 29. Brane setups inserting the HB operators of theory A: a) Z^2_1 ; b) Y_3 ; c) $Z^2_1(-Z^1_2)$ or $(\xi_1 - Y_1)(\xi_2 - Y_1)(Y_2 - Y_1)$; d) $Z^4_3 Z^3_2 Z^2_1$ or $Z^4_1(Y_1 - Y_2)(Y_2 - Y_3)$.

semi-infinite F1 or a single F1 leads to the identities between the operator inserted,

$$Z^{\alpha+1}_\alpha(-Z^\alpha_{\alpha+1}) = \begin{cases} Z^1_1(-X)(-Z^2_2) = (\xi_1 - Y_1)(\xi_2 - Y_1)(Y_2 - Y_1), & \alpha = 1, \\ (Z^\alpha_\alpha)(-Z^{\alpha+1}_{\alpha+1}) = (Y_{\alpha-1} - Y_\alpha)(Y_{\alpha+1} - Y_\alpha), & \alpha = 2, 3, \end{cases} \quad (5.44)$$

where each factor in the product corresponds to the contribution of a local brane ingredient (F1 ending on D3, F1 ending on D5, D3-NS5 intersection with F1, ...), as explained in detail in appendix B. We obtain the three relations

$$\begin{aligned} Z^2_1 Z^1_2 &= (Y_1 - Y_2)(\xi_1 - Y_1)(\xi_2 - Y_1), \\ Z^3_2 Z^2_3 &= (Y_1 - Y_2)(Y_2 - Y_3), \\ Z^4_3 Z^3_4 &= (Y_2 - Y_3)(Y_3 - \xi_4). \end{aligned} \quad (5.45)$$

The second set of configurations have a semi F1 stretched between a pair of D5 branes, $D5_{(\alpha)}-D5_{(\beta)}$, with $\alpha + 1 < \beta$, ending on the D3 segments from above or below. An example is shown in Figure 29-d. Looking at the setups as several semi F1 patches or a single semi F1 extended from $D5_{(\alpha)}$ to $D5_{(\beta)}$ leads to the second set of HB pre-

relations. For instance for $(\alpha, \beta) = (1, 3)$, we obtain the two relations

$$\begin{aligned} Z^3_2 Z^2_1 &= Z^3_1 Z^2_2 = Z^3_1 (Y_1 - Y_2), \\ (-Z^1_2)(-Z^2_3) &= (-Z^1_3)(-Z^2_2) = (-Z^1_3)(Y_2 - Y_1). \end{aligned} \tag{5.46}$$

In total we get the six pre-relations

$$\begin{aligned} Z^3_2 Z^2_1 &= Z^3_1 (Y_1 - Y_2), & Z^1_2 Z^2_3 &= Z^1_3 (Y_1 - Y_2), \\ Z^4_3 Z^3_2 &= Z^4_2 (Y_2 - Y_3), & Z^2_3 Z^3_4 &= Z^2_4 (Y_2 - Y_3), \\ Z^4_3 Z^3_2 Z^2_1 &= Z^4_1 (Y_1 - Y_2)(Y_2 - Y_3), & Z^1_2 Z^2_3 Z^3_4 &= Z^1_4 (Y_1 - Y_2)(Y_2 - Y_3), \end{aligned} \tag{5.47}$$

completing the three relations (5.45).

The analysis of the Coulomb branch of the T_B theory is completely analogous. A basis of CB generators is given by two sets of operators:

- For each pair of NS5 branes, NS5 $_{(i)}$ -NS5 $_{(j+1)}$, with $1 \leq i \leq j \leq 3$, there is a couple of operators $V_{[i:j]}^\pm$. The operator $V_{[i:j]}^+$ is associated to the contribution from a semi D1 string stretched between NS5 $_{(i)}$ and NS5 $_{(j+1)}$, ending on the D3 segments from above. The operator $-V_{[i:j]}^-$ is associated to the contribution from a semi D1 string stretched between NS5 $_{(i)}$ and NS5 $_{(j+1)}$, ending on the D3 segments from below. Figure 30-a presents the setup inserting the operator $V_{[1:1]}^+$.³⁵ In the gauge theory language the operators $V_{[i:j]}^\pm$ are monopoles of charge ± 1 under the $U(1)_{(k)}$ nodes for $i \leq k \leq j$, and vanishing charge under the other nodes.
- For each pair of adjacent NS5, NS5 $_{(i)}$ -NS5 $_{(i+1)}$ for $i = 1, 2, 3$, there is an operator φ_i , corresponding to the vector multiplet complex scalar of the i th node, whose insertion is achieved by adding a D3'' brane between NS5 $_{(i)}$ and NS5 $_{(i+1)}$, crossing the D3 segment stretched between them. Figure 30-b presents the setup inserting the operator φ_3 .

There are in total six operators V^\pm and three operators φ , so nine CB generators. As for the Higgs branch, the CB pre-relations are read from two kinds of brane setups.

The first setups consist of a full D1 stretched between two consecutive NS5s, NS5 $_{(i)}$ -NS5 $_{(i+1)}$, as in Figure 30-c for $i = 1$. Looking at these configurations as two semi-infinite D1, inserting the product of monopoles $V_{[i:i]}^+(-V_{[i:i]}^-)$, or as a single D1 leads to the three

³⁵As explained in previous sections, there is no setup inserting the operators $V_{[i:j]}^\pm$, with $|i - j| \geq 1$, alone.

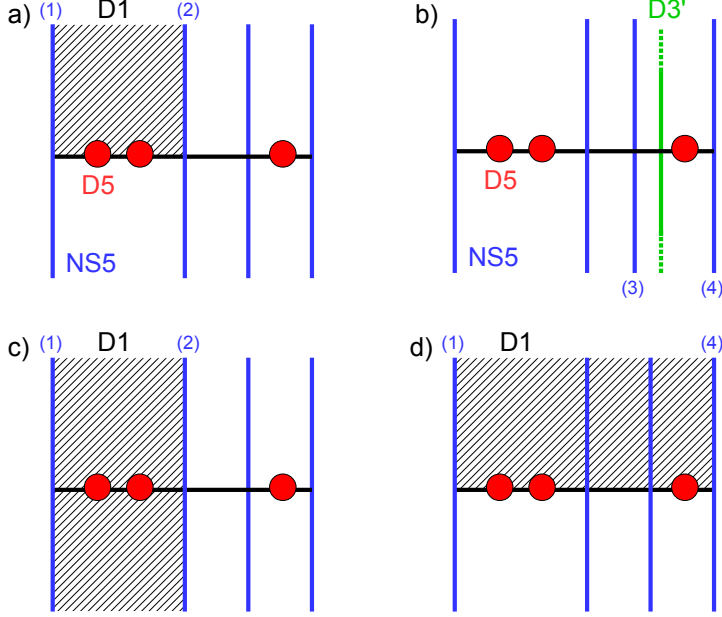

Figure 30. Brane setups inserting the CB operators of theory B: a) $V_{[1:1]}^+$; b) φ_3 ; c) $V_{[1:1]}^+(-V_{[1:1]}^-)$ or $(m_1 - \varphi_1)(m_2 - \varphi_2)(\varphi_2 - \varphi_1)$; d) $V_{[1:1]}^+ V_{[2:2]}^+ V_{[3:3]}^+$ or $V_{[1:3]}^+(\varphi_1 - \varphi_2)(\varphi_2 - \varphi_3)$.

identities

$$\begin{aligned}
-V_{[1:1]}^+ V_{[1:1]}^- &= (\tilde{m}_1 - \varphi_1)(\tilde{m}_2 - \varphi_2)(\varphi_2 - \varphi_1), \\
-V_{[2:2]}^+ V_{[2:2]}^- &= (\varphi_1 - \varphi_2)(\varphi_3 - \varphi_2), \\
-V_{[3:3]}^+ V_{[3:3]}^- &= (\varphi_2 - \varphi_3)(\tilde{m}_3 - \varphi_3).
\end{aligned} \tag{5.48}$$

The right-hand side factors $(\tilde{m}_i - \varphi_j)$ correspond to contributions from D1s crossing the $D3_{(j)}$ segment and intersecting $D5_{(i)}$ at a point, and the factors $\pm(\varphi_i - \varphi_{i-1})$ corresponds to the contributions of a NS5-D3 intersection with a D1 ending on the NS5 from the left or from the right.

The second kind of configurations have a semi D1 stretched between a pair of NS5 branes, $NS5_{(i)}-NS5_{(j+1)}$, with $i < j$, ending on the D3 segments from above or from below. The case $(i, j) = (1, 3)$ is presented in Figure 30-d. Looking at the setups as several semi D1s inserting the product of monopole operators $\prod_{k=i}^j (\pm V_{[k:k]}^\pm)$ or a single

semi D1 extended from $\text{NS5}_{(i)}$ to $\text{NS5}_{(j+1)}$ leads to the six remaining CB pre-relations

$$\begin{aligned}
V_{[1:1]}^\pm V_{[2:2]}^\pm &= V_{[1:2]}^\pm (\varphi_1 - \varphi_2), \\
V_{[2:2]}^\pm V_{[3:3]}^\pm &= V_{[2:3]}^\pm (\varphi_2 - \varphi_3), \\
V_{[1:1]}^\pm V_{[2:2]}^\pm V_{[3:3]}^\pm &= V_{[1:3]}^\pm (\varphi_1 - \varphi_2)(\varphi_2 - \varphi_3).
\end{aligned}
\tag{5.49}$$

The relations (5.48) and (5.49) are the pre-relations from which one can extract the full set of CB relations of the T_B theory.

Mirror symmetry:

From our description of the HB and CB operators from brane setups, it is immediate to identify the mirror map. The setups realizing the HB operator insertions in theory A are S-dual to the setups realizing the CB operator insertions in theory B (Figures 29-a,b are S-dual to Figures 30-a,b), and the setups realizing the HB pre-relations in theory A are S-dual to the setups realizing pre-relations in theory B (Figures 29-c,d are S-dual to Figures 30-c,d). This leads to the mirror map of operators and parameters presented in Table 5 and the map between the pre-relations (5.45) and (5.48) on one side, and between the pre-relations (5.47) and (5.49) on the other side.

Theory A: HB	Theory B : CB
$Y_i \quad (i = 1, 2, 3)$	φ_i
$Z^{j+1}_i \quad (i \leq j)$	$V_{[i:j]}^+$
$Z^i_{j+1} \quad (i \leq j)$	$V_{[i:j]}^-$
Theory A: FI param.	Theory B: mass param.
ξ_1, ξ_2, ξ_3	$\tilde{m}_1, \tilde{m}_2, \tilde{m}_3$

Table 5. Mirror map of HB operators of T_A and CB operators of T_B , and mirror map of FI and mass parameters.

6 Other chiral operators

So far the discussion has been focused solely on finding the brane setups inserting HB and CB operators entering in bases of the chiral rings. In the gauge theory description of the Coulomb branch it is natural to consider monopole operators of higher magnetic charges. Ultimately these higher charge monopoles are expressed through additional relations in terms of the monopole operators of lower charge forming a basis of the

Coulomb branch. In the description of the Higgs branch these redundant operators are simply products of mesons. For completeness we discuss in this section the brane setups inserting some of these higher charge operators (or these products of operators).

On the Higgs branch side, products of meson operators can be realized by brane setups with several F1 strings and/or several D3' branes. For instance, in the $T[SU(2)]$ theory studied in Section 4 one can consider the setup with n semi F1 strings stretched between the two D5s and ending on the D3 from above, as shown in Figure 31-a. Each semi F1 inserts a factor of the meson operator Z^2_1 , leading to the total insertion of $(Z^2_1)^n$. We can also consider the setup with several m D3' branes positioned between the two D5s, as in Figure 31-b, inserting the product of operators $Y^m \equiv (-Z^1_1 - \xi_1)^m = (Z^2_2 - \xi_2)^m$. A setup inserting the product $Z^2_1 Y^2$ is shown in Figure 31-c. Notice that

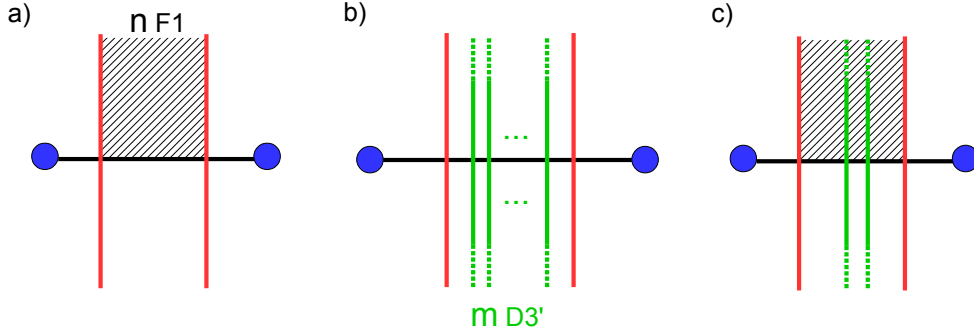

Figure 31. Products of HB operators (mesons) are inserted by adding several F1 strings and D3' branes to the setups. a) n semi F1s inserting $(Z^2_1)^n$, b) m D3's inserting $Y^m = (Z^2_2 - \xi_2)^m$, c) One semi F1 and two D3's inserting $Z^2_1 Y^2$.

the s-rule (see Section 3.1) forbids to attach more than one F1 string between a D3' and a D5 brane, therefore the only way to have several strings attached to a D3' brane is that each of them ends on a different D5. This restricts the set of possible configurations. For the $T[SU(2)]$ theory, the various brane setups realize all the products of mesons $(Z^2_1)^{n_1} (Z^1_2)^{n_2} Y^{n_3}$, for $n_1, n_2, n_3 \geq 0$.

On the Coulomb branch side, there are monopole operators V_A of arbitrary magnetic charge $A \in \mathbb{Z}^M$ under a $U(1)^M$ Cartan gauge symmetry, dressed by products of scalar operators φ_i [12]. These higher charge monopoles are realized by brane setups with several D1 strings and D3'' branes. In the simple case of the $T[SU(2)]$ theory, we can consider n semi D1s stretched between the two NS5s and ending on the D3 segment from above, as in Figure 32-a. The insertion corresponds to a monopole operator V_n of charge n . It can also be interpreted as the product of monopole operators $(u^+)^n$, leading to the CB relation $V_n = (u^+)^n$. The setup of Figure 32-b with m D3'' branes

inserts the products of scalars φ^m . The setup of Figure 32-c inserts the operator $u^+\varphi^2$. Here also the possible brane setups are restricted by the s-rule which imposes that there is at most a single D1 string stretched between a D3'' brane and an NS5 brane.

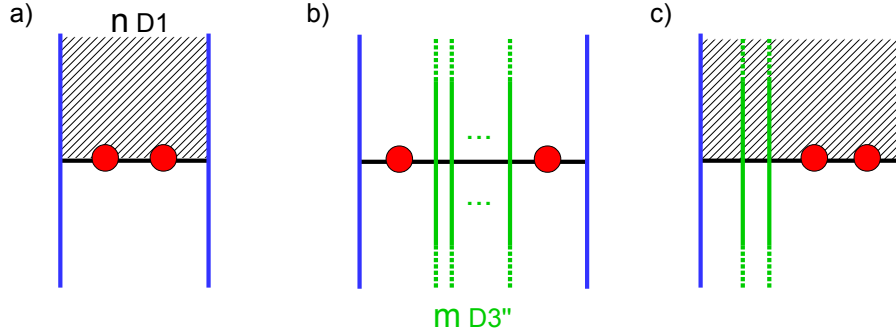

Figure 32. Products of CB operators are inserted by adding several D1 strings and D3'' branes to the setups. a) n semi D1s inserting $(u^+)^n$, b) m D3''s inserting φ^m , c) One semi D1 and two D3''s inserting $u^+\varphi^2$.

These three brane setups of Figure 32 are S-dual to those of Figure 31, confirming the mirror map between operators $(u^+, \varphi) \leftrightarrow (Z^2_1, Y)$.

In more sophisticated abelian theories one can consider richer setups which have many interpretations, corresponding to operator insertions identified by ring relations. Let us give one example. We consider the CB operator insertion in the theory B of Section 5.4 given by the brane setup of Figure 33. The presence of the two D3'' branes corresponds to the insertion of the product $\varphi_1\varphi_3$. The insertion due to the D1 branes can be interpreted in various ways. As four distinct semi D1s, they insert the products $-V_{(2,0,0)}V_{(0,1,0)}V_{(0,-1,0)} = -(V_{(1,0,0)})^2V_{(0,1,0)}V_{(0,-1,0)}$. Recombining the two semi D1 in the middle across the D3 segment leads to the insertion of $V_{(2,0,0)}(\varphi_1 - \varphi_2)(\varphi_3 - \varphi_2) = (V_{(1,0,0)})^2(\varphi_1 - \varphi_2)(\varphi_3 - \varphi_2)$. Recombining instead two D1s on the upper side across the NS5 leads to the insertion of $-V_{(2,1,0)}(\varphi_1 - \varphi_2)V_{(0,-1,0)} = -V_{(1,0,0)}V_{(1,1,0)}(\varphi_1 - \varphi_2)V_{(0,-1,0)}$. Here we denoted $V_{(n_1, n_2, n_3)}$ the monopole operator of charge (n_1, n_2, n_3) . All these operators are equal by the CB relations. The relations that we obtain from such complicated setups are therefore correct but redundant. The operators $V_{(2,0,0)}$ and $V_{(2,1,0)}$ can be eliminated by the relations $V_{(2,0,0)} = (V_{(1,0,0)})^2$ and $V_{(2,1,0)} = V_{(1,0,0)}V_{(1,1,0)}$ (which follow from simpler brane setups).

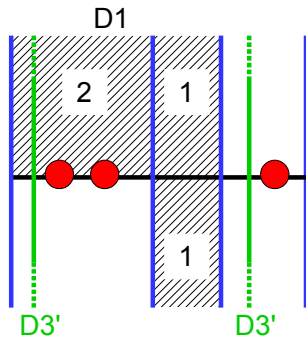

Figure 33. Setup with D1s and D3's. The numbers indicate the number of superposed D1s in each region. The setup can be interpreted as inserting for instance the operators $-V_{(2,0,0)}V_{(0,1,0)}V_{(0,-1,0)}\varphi_1\varphi_3$ or $(V_{(1,0,0)})^2(\varphi_1 - \varphi_2)(\varphi_3 - \varphi_2)\varphi_1\varphi_3$.

7 Non-abelian theories

It would be very interesting to generalize this analysis to non-abelian theories and to find a set of simple rules to derive the non-abelian Coulomb branch relations and the mirror maps in a systematic way. This generalization is not straightforward, in the sense that it is not obvious that brane setups can be found which insert each of the CB and HB operators in non-abelian theories with brane realizations.. However, by a simple analysis, we can derive the *abelianized relations* discussed in [12], from which one can extract the actual CB relations of the non-abelian theory by the method explained in that paper³⁶. These are the Coulomb branch relations of the abelian low-energy theory that one obtains by moving at a generic point of the Coulomb branch with corrections due to massive W-bosons. It is worth noting that the abelianized relations were postulated³⁷ in [12] and that the present discussion constitutes a direct derivation of these relations relying on brane technology.

Let us consider the simple example of $U(N)$ SQCD with N_f fundamental hypermultiplets. The gauge field A_μ and the complex scalar φ belong to the $\mathfrak{u}(N)$ algebra and we can view them as $N \times N$ matrices. One can define a monopole operator $M_{A,p}$ by specifying Dirac monopole singularities with integer charges $A = (\mathbf{n}_1, \mathbf{n}_2, \dots, \mathbf{n}_N)$ for the diagonal components of the gauge field at a point in space. This breaks the

³⁶The basic idea is the following. Each non-abelian operator can be expressed as a gauge invariant polynomial in the abelian operators (*abelianization map*) and the abelianized relations can be re-expressed as relations between the non-abelian operators, giving the CB relations of the non-abelian theory.

³⁷Except for the Coulomb branch relation for $\mathcal{N} = 4$ SQED which was derived in [3] using CFT methods.

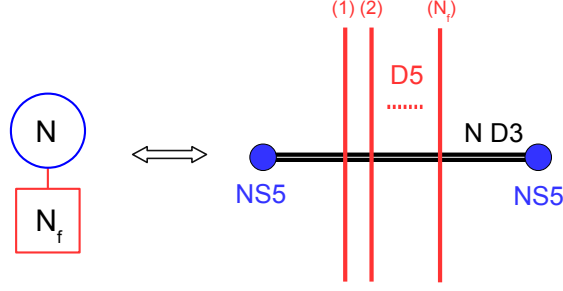

Figure 34. Quiver diagram and brane realization of $U(N)$ SQCD.

gauge group $U(N)$ to a subgroup H , which is generically a maximal torus $U(1)^N$. The monopole operator is then dressed with an H -invariant polynomial $p(\varphi_H)$ of the complex scalar φ restricted to H , which is generically a polynomial of the diagonal elements φ_a , $a = 1, \dots, N$. The abelianization map of [12] maps a non-abelian monopole operator $M_{A,p}$ to a combination of monopole operator V_A dressed with complex scalars φ_a of the low-energy abelian theory of generic Coulomb branch loci. The Coulomb branch of the non-abelian theory is a sub-ring of the Coulomb branch of the abelian theory and the non-abelian ring relations can be extracted from “abelianized relations” involving the operators of the abelian theory.

In the case of SQCD with N_f flavors, the abelianized relations read³⁸

$$u_a^+ u_a^- = - \frac{\prod_{\alpha=1}^{N_f} (m_\alpha - \varphi_a)}{N \prod_{\substack{b=1 \\ b \neq a}}^N (\varphi_b - \varphi_a)^2}, \quad a = 1, \dots, N, \quad (7.1)$$

where u_a^\pm, φ_a , $a = 1, \dots, N$, are the abelian monopole operators and complex scalar operators of the $U(1)^N$ low-energy abelian theory at a generic point on the Coulomb branch. The difference with the relations of actual abelian quiver theories is the presence of the factors $(\varphi_b - \varphi_a)^2$ in the denominator on the right hand side, due to the presence of massive W-bosons in the low-energy theory on the Coulomb branch. A basis of generators of the non-abelian Coulomb branch is given by Weyl invariant combinations of the abelian operators u_a^\pm, φ_a with minimal magnetic charge, $M_n^\pm = \sum_{a=1}^N u_a^\pm \prod_{b_1 \neq \dots \neq b_n \neq a} \varphi_{b_1} \cdots \varphi_{b_n}$ and vanishing magnetic charge, $\Phi_n = \sum_{a_1 \neq \dots \neq a_n} \varphi_{a_1} \cdots \varphi_{a_n}$. The non-abelian CB relations obeyed by these operators amounts to rewriting the

³⁸There is a sign difference with respect to the formula in [12], which can be absorbed in a redefinition of the vector multiplet complex scalars by a minus sign.

abelianized relations (7.1) in terms of these Weyl invariant generators, as detailed in [12]. We propose to recover the (crucial) abelianized relations (7.1) from a brane setup.

The brane configuration realizing $U(N)$ SQCD with N_f hyper-multiplets as its low-energy limit consists of N D3 segments stretched between two NS5 branes with N_f D5 branes crossing the D3s (Figure 34). In the brane picture, moving to a generic point on the Coulomb branch by giving vevs to the diagonal components φ_a of the complex scalar is achieved by moving the D3 segments along the x^{8+i9} direction, with the position of the D3 segments corresponding to the abelian scalar vevs $\langle \varphi_a \rangle$, $a = 1, \dots, N$.

To obtain the abelianized relations the relevant brane setup is that of Figure 35, where the D3 segments are separated. In addition the setup has a D1 brane stretched between the two NS5s and intersecting one of the D3 segments, say the $D3_{(a)}$ segment supporting the $U(1)_{(a)}$ Cartan gauge symmetry. This setup can be interpreted as two semi D1 branes ending on $D3_{(a)}$ inserting the product of abelian monopole operators $-u_a^+ u_a^-$ according to the rules explained in previous sections.³⁹

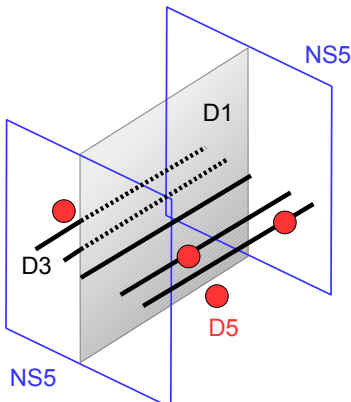

Figure 35. Brane setup in the 3d space (x^3, x^7, x^8) with a D1 string stretched between the two NS5s and intersecting a D3 brane. In this example there are $N = 5$ D3s and $N_f = 4$ D5s.

The second interpretation is that of a single D1 brane crossing the D3. This setup is essentially the same as that of Section 4.3 and Figure 11. The operator insertion comes from integrating out the low-energy fields living on the D1 and those living at the D1-D5 and D1-D3 intersections.

The D1 brane theory is a 2d $\mathcal{N} = (8, 8)$ $U(1)$ vector multiplet placed on an interval with half-BPS Neumann boundary conditions. These boundary conditions set to zero

³⁹As in Section 4.2, we assume here that there is no contribution to the operator insertion from D1-D5 or D1-D3 string modes. This can be heuristically understood by noting that a semi D1 is dissolved into the D3 segment (or forms a spike) so that there is no separate D1-D5 or D1-D3 strings, but only D3-D5 and D3-D3 strings.

three out of the eight real scalars and the vector field component along x^3 . In the low energy limit the massless modes make an 1d $\mathcal{N} = (4, 4)$ vector multiplet, which has five scalars corresponding to the motions of the D1 along the directions $x^{0,1,2,7,8}$.

The D1-D3_b open string low modes make a 1d hypermultiplet living on the interval between the two NS5s. The fields of the hyper-multiplet are $(q_r, \psi_{\pm}^{\dot{r}})$, $r = 1, 2$, $\dot{r} = 1, 2$, where q_r denote the two complex scalars and $\psi_{\pm}^{\dot{r}}$ the four fermions, which have a single complex component in 1d. As is frequently the case when dealing with a supersymmetric theory on Euclidean space it will be useful to treat the conjugate fields $(\bar{q}^r, \bar{\psi}_{\pm \dot{r}})$ as independent fields to begin with. The hyper-multiplet has charge $(1, -1)$ under the $U(1)_{\text{D1}} \times U(1)_{\text{D3}}$ gauge symmetries and therefore is coupled to the 2d and 3d vector multiplets living on the D1 and D3 respectively. The couplings are canonical couplings to 1d $N = (4, 4)$ vector multiplets embedded inside the 2d and 3d vector multiplets. In particular the 2d and 3d vector multiplet scalars appear as masses for the 1d hyper-multiplet.⁴⁰

The boundary conditions on this hyper-multiplet at the boundaries of the interval, compatible with the Neumann boundary conditions for the vector multiplets, are imposing $\partial_3 q_r = 0$. Since the boundary condition is half-BPS, half of the fermions are set to zero at the boundaries as well, while the other half obeys the Neumann condition $\partial_3 \psi = 0$. To understand this in detail, let us write the low-energy effective action and the supersymmetry transformations, keeping all the fermions for the moment. In the low-energy limit the theory is zero dimensional and the only term in the action is a mass coupling to the vector multiplet scalars which are not set to zero by the boundary conditions,⁴¹

$$S_{0\text{d}} = |\Phi|^2 \bar{q}^r q_r + \Phi \bar{\psi}_{+\dot{r}} \psi_{-}^{\dot{r}} + \bar{\Phi} \bar{\psi}_{-\dot{r}} \psi_{+}^{\dot{r}}, \quad (7.2)$$

where $\Phi = \varphi_b - \varphi_a$ is the complex mass of the 0d hyper-multiplet, computed as the difference between the D3_(b) position φ_b and the D1 position φ_a along x^{8+i9} . The 0d supersymmetry transformations obtained by dimensional reduction of the 2d $N = (4, 4)$

⁴⁰In this analysis the 2d and 3d fields can be treated as background fields.

⁴¹In principle there should be additional Yakawa couplings involving the fermions of the 2d and 3d vector multiplets, which are the superpartners of Φ . Here we perform the computation in the situation when these background fermions are set to zero, assuming that the final result is unchanged when they are turned on. The fact that we obtain in the end a supersymmetric chiral operator after integrating out the 0d theory and that these background fermions do not enter in chiral operators justifies this assumption.

transformations (or from 6d $N = (1, 0)$) are

$$\begin{aligned}
\delta q_r &= \psi_-^{\dot{r}} \epsilon_{+r\dot{r}} + \psi_+^{\dot{r}} \epsilon_{-r\dot{r}}, & \delta \bar{q}^r &= -\bar{\psi}_{\dot{r}+} \epsilon_+^{r\dot{r}} - \bar{\psi}_{\dot{r}-} \epsilon_-^{r\dot{r}}, \\
\delta \psi_+^{\dot{r}} &= \Phi q_r \epsilon_-^{r\dot{r}}, & \delta \bar{\psi}_{+\dot{r}} &= \bar{\Phi} \bar{q}^r \epsilon_{+r\dot{r}}, \\
\delta \psi_-^{\dot{r}} &= \bar{\Phi} q_r \epsilon_+^{r\dot{r}}, & \delta \bar{\psi}_{-\dot{r}} &= \Phi q^r \epsilon_{-r\dot{r}},
\end{aligned} \tag{7.3}$$

where $\epsilon_{\pm r\dot{r}}$ parametrize eight supercharges. Out of these eight supercharges, four are broken by the boundary conditions on the interval, which set to zero half of the fermions. There are several choices of which fermions to set to zero, each preserving a certain subset of supercharges. Studying the different choices we find that there is a single choice leading to an operator insertion preserving the supercharges of a Coulomb branch operator, which are the supercharges preserved by the original brane configuration. The correct boundary condition is then

$$\bar{\psi}_{+\dot{r}} = \psi_-^{\dot{r}} = 0, \tag{7.4}$$

preserving the four supercharges parametrized by $\epsilon_{-r\dot{r}}$, leading to a 0d $\mathcal{N} = (4, 0)$ theory. This analysis indicates that the appropriate reality condition on the 0d fermions is not the usual Lorentzian reality condition $(\psi_{\pm}^{\dot{r}})^* = \pm \bar{\psi}_{\pm\dot{r}}$ and $(\epsilon_{\pm r\dot{r}})^* = \mp \epsilon_{\mp}^{r\dot{r}}$, which would lead to a real action, but instead we have $(\psi_{\pm}^{\dot{r}})^* = \pm \bar{\psi}_{\mp\dot{r}}$ and $(\epsilon_{\pm r\dot{r}})^* = \mp \epsilon_{\pm}^{r\dot{r}}$ and a complex action. After setting $\psi_-^{\dot{r}} = 0$, we obtain

$$S_{\text{0d}} = |\Phi|^2 \bar{q}^r q_r + \bar{\Phi} \bar{\psi}_{-\dot{r}} \psi_+^{\dot{r}}. \tag{7.5}$$

Integrating out the two complex scalars q^r and the two complex fermions $\psi_+^{\dot{r}}$ leads to the operator insertion

$$\frac{\bar{\Phi}^2}{|\Phi|^4} = \frac{1}{\Phi^2} = \frac{1}{(\varphi_b - \varphi_a)^2}, \tag{7.6}$$

which is indeed a CB operator, confirming that we have correctly derived the boundary conditions on the hyper-multiplet fermions.

In the brane setup (Figure 35) there are N D1-D3 hyper-multiplets, however one of them, the D1-D3_(a) is massless, since the D1 is exactly crossing D3_(a) and its contribution is diverging. The path integral must be regularized by removing the massless modes. This leaves the contribution of the $N - 1$ massive hyper-multiplets

$$\frac{1}{\prod_{b \neq a} (\varphi_b - \varphi_a)^2}. \tag{7.7}$$

In addition there are N_f zero-dimensional fermions with complex masses $m_\alpha - \varphi_a$ sourced by the D1-D5_(α) open strings modes, with $\alpha = 1, \dots, N_f$. As explained in Section 4.3, integrating out these fermions lead to the insertion of the product of CB operators $\prod_{\alpha=1}^{N_f} (m_\alpha - \varphi_a)$. The total operator insertion is then

$$\frac{\prod_{\alpha=1}^{N_f} (m_\alpha - \varphi_a)}{\prod_{b \neq a} (\varphi_b - \varphi_a)^2}. \quad (7.8)$$

Equating this insertion with the product of abelian monopoles $-u_a^+ u_a^-$ obtained by the first interpretation of the brane setup reproduces the SQCD abelianized relation (7.1).

Once again we have shown that the Coulomb branch relations can be derived by studying specific brane setups. This analysis can be generalized to deriving the abelianized ring relations of arbitrary non-abelian linear quiver theory with unitary nodes, from which the Coulomb branch relations of the non-abelian theory are derived following the approach of [12]. We did not find a way to extract directly the non-abelian CB relations from the brane picture. It might be possible however to extract the mirror map of operators in a simple way. We leave this analysis for future work.

Finally we can comment on the derivation of the Higgs branch relations in non-abelian theories. These relations are usually derived from the description of the Higgs branch as a hyper-Kähler quotient (or a holomorphic quotient), which follows from the Lagrangian description of the theory. However one may wonder how the Higgs branch would arise from the brane approach. It is beyond the scope of this paper to provide the algorithmic derivation of non-abelian Higgs branch relations from branes, but we can sketch how this would work. As in the Coulomb branch analysis above, the idea would be to derive the equivalent of abelianized relations from brane setups and to construct the non-abelian relations from them. The analogue of the low-energy abelian theory at generic points on the Coulomb branch is the low-energy free hypermultiplets theory at generic points on the Higgs branch⁴², which corresponds to moving D3 segments stretched between D5s along the $x^{5,6}$ directions. In this “free theory” the HB operators are inserted by F1 strings stretched between couples of D5s and ending on a given D3 segment, and by D3’ branes placed between neighboring D5s and crossing a given D3 segment. These are the analogue the abelian operators u_a^\pm, φ_a in the Coulomb branch analysis above. The HB operators in the non-abelian theory are then constructed as polynomials in the free theory operators which are invariant under permutations of the D3 segments (note that this is not the Weyl group of the non-abelian theory). The non-abelian HB relations would be obtained from a set of relations, which are the analogue

⁴²If the theory is *bad* in the sense of [17] there is some residual interacting gauge theory as well.

of the abelianized relations for the Coulomb branch. These relations would follow from brane setups with full F1 strings stretched between two D5s and crossing a D3 segment. The details of the brane reading procedure would need a longer discussion and there might be additional brane setups to be considered to obtain the full set of Higgs branch relations in a generic non-abelian theory. The simplest situation where one could test this method would be for a non-abelian quiver theory whose brane realization has only two D5s (two fundamental hypermultiplets).

The main idea is that the brane analysis provides a derivation of the abelianized relations for the Coulomb branch and of an analogue set of relations for the Higgs branch, from which the CB and HB relations of the non-abelian theory can be derived following the method of [12].

Acknowledgments

We wish to thank Costas Bachas, Stefano Cremonesi, Davide Gaiotto, Jaume Gomis and Noppadol Mekareeya for enlightening discussions related to this work. This research was supported in part by Perimeter Institute for Theoretical Physics. Research at Perimeter Institute is supported by the Government of Canada through the Department of Innovation, Science and Economic Development and by the Province of Ontario through the Ministry of Research, Innovation and Science.

A SQED Higgs branch relations

In this appendix we show that the per-relations (5.6), (5.9) and (5.10), following from the brane setup analysis, imply the trivial Higgs branch relations (5.2).

Let us assume $\alpha < \beta < \gamma < \delta$. Using (5.9) and (5.10), we have

$$\begin{aligned}
Z^\delta_\alpha \prod_{\epsilon=\alpha+1}^{\delta-1} Z^\epsilon_\epsilon &= \prod_{\epsilon=\alpha}^{\delta-1} Z^{\epsilon+1}_\epsilon = Z^\beta_\alpha \left(\prod_{\epsilon=\alpha+1}^{\beta-1} Z^\epsilon_\epsilon \right) \left(\prod_{\epsilon=\beta}^{\gamma-1} Z^{\epsilon+1}_\epsilon \right) Z^\delta_\gamma \left(\prod_{\epsilon=\gamma+1}^{\delta-1} Z^\epsilon_\epsilon \right) \\
Z^{\beta}_\gamma \prod_{\epsilon=\beta+1}^{\gamma-1} Z^\epsilon_\epsilon &= \prod_{\epsilon=\beta}^{\gamma-1} Z^\epsilon_{\epsilon+1}.
\end{aligned} \tag{A.1}$$

Multiplying these two equations together we obtain

$$\begin{aligned}
Z^\delta_\alpha Z^\beta_\gamma \prod_{\epsilon=\alpha+1}^{\delta-1} Z^\epsilon_\epsilon \prod_{\epsilon=\beta+1}^{\gamma-1} Z^\epsilon_\epsilon &= Z^\beta_\alpha Z^\delta_\gamma \left(\prod_{\epsilon=\alpha+1}^{\beta-1} Z^\epsilon_\epsilon \right) \left(\prod_{\epsilon=\gamma+1}^{\delta-1} Z^\epsilon_\epsilon \right) \left(\prod_{\epsilon=\beta}^{\gamma-1} Z^{\epsilon+1}_\epsilon Z^\epsilon_{\epsilon+1} \right) \\
&= Z^\beta_\alpha Z^\delta_\gamma \left(\prod_{\epsilon=\alpha+1}^{\beta-1} Z^\epsilon_\epsilon \right) \left(\prod_{\epsilon=\gamma+1}^{\delta-1} Z^\epsilon_\epsilon \right) \left(\prod_{\epsilon=\beta}^{\gamma-1} Z^\epsilon_\epsilon Z^{\epsilon+1}_{\epsilon+1} \right) \quad (\text{A.2}) \\
&= Z^\beta_\alpha Z^\delta_\gamma \prod_{\epsilon=\alpha+1}^{\delta-1} Z^\epsilon_\epsilon \prod_{\epsilon=\beta+1}^{\gamma-1} Z^\epsilon_\epsilon,
\end{aligned}$$

where the second equality follows from using (5.6). Dividing by $\prod_{\epsilon=\alpha+1}^{\delta-1} Z^\epsilon_\epsilon \prod_{\epsilon=\beta+1}^{\gamma-1} Z^\epsilon_\epsilon$ on both side yields

$$Z^\delta_\alpha Z^\beta_\gamma = Z^\beta_\alpha Z^\delta_\gamma, \quad (\text{A.3})$$

which is the Higgs branch relation (5.2). This can be done when $\prod_{\alpha < \epsilon < \delta} Z^\epsilon_\epsilon \prod_{\beta < \epsilon < \gamma} Z^\epsilon_\epsilon \neq 0$. We know that the relation still holds even when this product vanishes, but, strictly speaking this does not follow from the relations (5.6), (5.9) and (5.10), and we must add this freedom to divide on both side of a relation by the Z^ϵ_ϵ operators to obtain the full set of HB relations.

The relations with a different ordering between $\alpha, \beta, \gamma, \delta$, as well as the cases when some of these indices are equal, can be obtained with similar computations, without difficulty.

B Brane setup - Operator insertion dictionary

In this appendix we summarize the rules for inserting/reading Higgs branch and Coulomb branch operators from brane setups and we provide the general mirror map of operators and deformation parameters.

The HB operator insertions require a little more effort to extract than the CB insertions. This is related to the fact that the brane setups automatically solve for the F-term conditions, so that the natural operator insertions are sometimes combinations of the standard meson operators.

In the brane configuration realizing the abelian quiver theory with M nodes and K fundamental hyper-multiplets, we label the NS5 branes as NS5_(i) with $i = 1, \dots, M+1$, increasing from left to right, and the D5 branes as D5_(\alpha) with $\alpha = 1, \dots, K$, increasing from left to right as well.

B.1 Higgs branch operators

To each $D5_{(\alpha)}$ -D3 intersection is associated a fundamental hyper-multiplet with complex scalars $(Q^\alpha, \tilde{Q}_\alpha)$, sourced by the D5-D3 open strings. To each $NS5_{(i)}$ -D3 intersection is associated a bifundamental hyper-multiplet with complex scalars (q_i, \tilde{q}_i) , sourced by the $D3_{(i-1)}$ -D3 $_{(i)}$ open strings stretched across the NS5.

An F1 string ending on a $D5_{(\alpha)}$ -D3 corner corresponds to the insertion of a scalar operator Q^α , or $\pm\tilde{Q}_\alpha$ as described in Figure 36-a,b,c,d, and an F1 string ending on the D3 of a $NS5_{(i)}$ -D3 intersection corresponds to the insertion of a scalar operator q_i or $-\tilde{q}_i$, as described in Figure 36-e,f.

In terms of gauge invariant meson operators we have meson insertions according to the prescriptions of Figure 37. In addition there are setups involving D3' branes which also insert meson operators. Those insertions are affected by the FI term deformations $\eta_i = \xi_i - \xi_{i+1}$, with ξ_i corresponding to the position of $NS5_{(i)}$. They are shown in Figure 38. The mesons Y_α inserted by the setups with a D3' standing between $D5_{(\alpha)}$ and $D5_{(\alpha+1)}$ are related to the mesons Z^α inserted by the setups of Figure 37-a,b,c,d,e by the relation

$$\begin{aligned} Z^\alpha_\alpha &= Y_{\alpha-1} - Y_\alpha, \quad \alpha = 1, \dots, K, \\ X_i &= Y_{\delta(i)} - \xi_i, \quad \text{with } NS5_{(i)} \in [D5_{(\delta(i))}, D5_{(\delta(i)+1)}], \end{aligned} \tag{B.1}$$

where $Y_{-1} = \xi_1$ and $Y_K = \xi_{M+1}$, and for the second relation $\delta(i)$ is defined by the fact that $NS5_{(i)}$ sits between $D5_{(\delta(i))}$ and $D5_{(\delta(i)+1)}$ in the brane setup. The meson operators inserted by the setups of Figure 37 and 38 form a basis of the HB chiral ring.

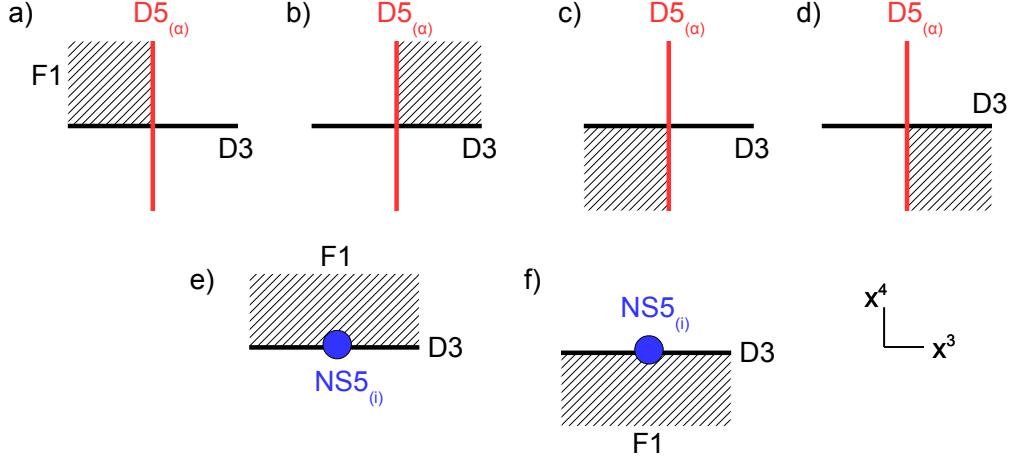

Figure 36. Setups inserting hyper-multiplet scalar operators. The insertions are: a) Q^a , b) \tilde{Q}_a , c) $-\tilde{Q}_a$, d) Q^a , e) q_i , f) $-\tilde{q}_i$.

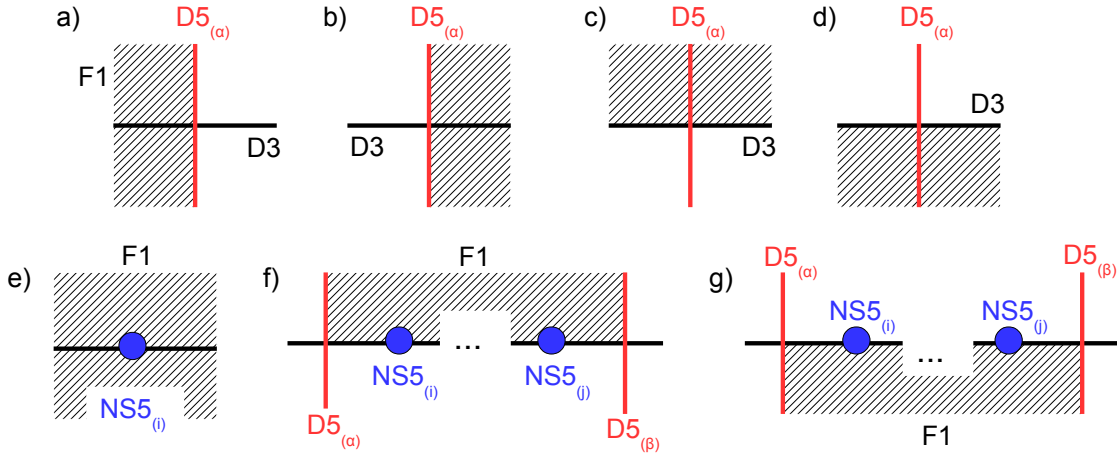

Figure 37. Setups with F1 strings inserting HB operators (mesons). The insertions are: a) $-Z^\alpha_\alpha \equiv -\tilde{Q}_\alpha Q^\alpha$, b) Z^α_α , c) Z^α_α , d) $-Z^\alpha_\alpha$, e) $-X_i \equiv -q_i \tilde{q}_i$, f) $Z^\beta_\alpha \equiv \tilde{Q}_\alpha (\prod_{k=i}^j q_k) Q^\beta$, g) $-Z^\alpha_\beta \equiv (-)^{i-j} Q^\alpha (\prod_{k=i}^j \tilde{q}_k) \tilde{Q}_\beta$.

B.2 Coulomb branch operators

To a $D3_{(i)}$ segment stretched between $NS5_{(i)}$ and $NS5_{(i+1)}$, is associated a $U(1)_{(i)}$ gauge symmetry and the vector multiplet complex scalar φ_i , whose insertion is realized by the brane setup of Figure 39, with a $D3''$ brane crossing the $D3_{(i)}$ segment. In addition the setups with D1 and $NS5_{(i)}$ branes of Figure 40-a,b,c,d correspond to the insertions of the combinations of complex scalars $\pm(\varphi_{i-1} - \varphi_i)$ and the setup with D1 and $D5_{(\alpha)}$

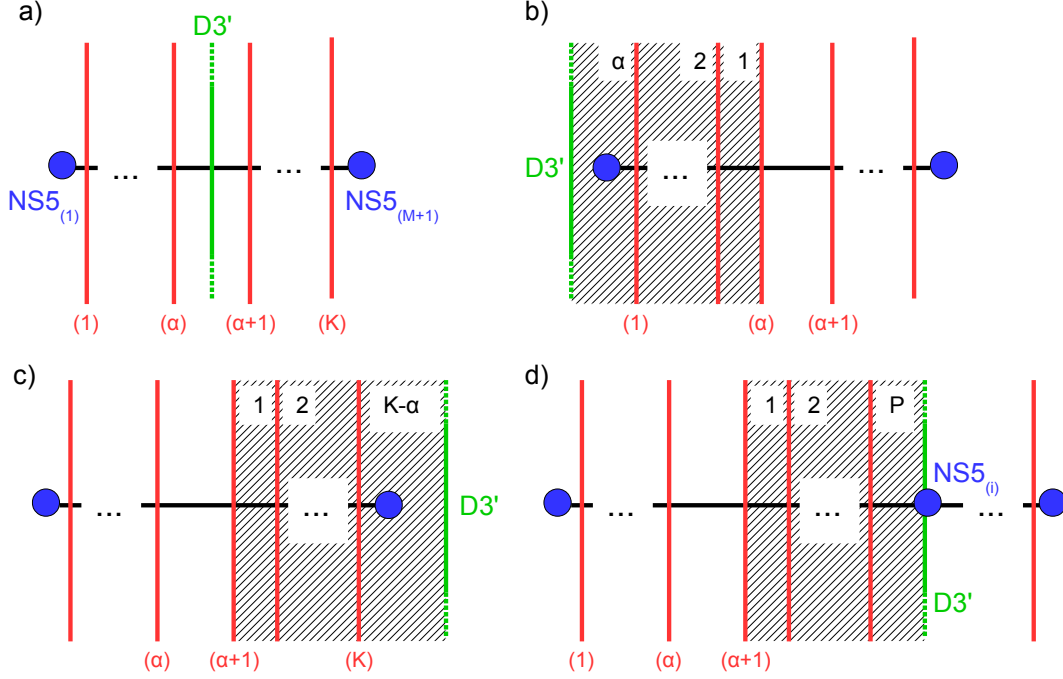

Figure 38. Setups with $D3'$ branes inserting HB operators. The insertion of the figures a,b,c and d are related by HW $D3'$ move and insert the same operator $Y_\alpha \equiv \xi_1 - \sum_{\gamma=1}^{\alpha} Z^{\gamma}_{\gamma} = \xi_{M+1} + \sum_{\gamma=\alpha+1}^K Z^{\gamma}_{\gamma} = \xi_i + X_i + \sum_{\gamma=\alpha+1}^{\alpha+P} Z^{\gamma}_{\gamma}$ (F-term constraints).

branes of Figure 40-e corresponds to the insertion of $(m_\alpha - \varphi_i)$, with m_α the complex mass of the hyper-multiplet sourced by the D5.

The insertion of monopole operators are related to the brane setups of Figure 41. To a pair of NS5 branes, $NS5_{(i)}-NS5_{(j+1)}$ with $i \leq j$, with a D1 string stretched between them and ending on the D3 segments, is associated the monopole operators $V_{[i:j]}^+$ or $-V_{[i:j]}^-$, depending whether the D1 end on the D3 from above or from below, which have magnetic charges $+1$ or -1 under each $U(1)_{(k)}$ with $i \leq k \leq j$.

The CB operators inserted by the setups of Figure 39 and 41 form a basis of the Coulomb branch chiral ring.

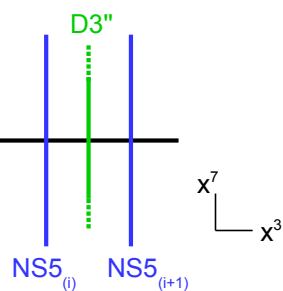

Figure 39. Setup with a $D3''$ brane crossing the $D3_{(i)}$ segment, inserting φ_i .

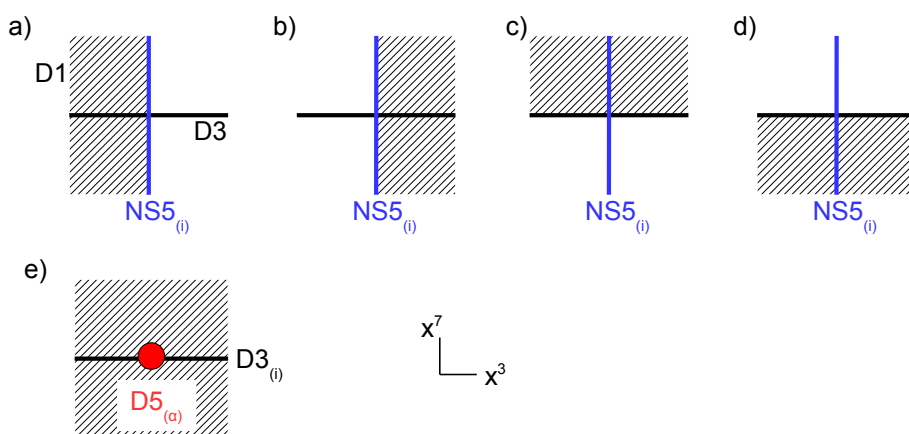

Figure 40. Setups with D1 strings inserting scalar CB operators. The insertions are: a) $\varphi_i - \varphi_{i-1}$, b) $\varphi_{i-1} - \varphi_i$, c) $\varphi_i - \varphi_{i-1}$, d) $\varphi_{i-1} - \varphi_i$, e) $m_\alpha - \varphi_i$.

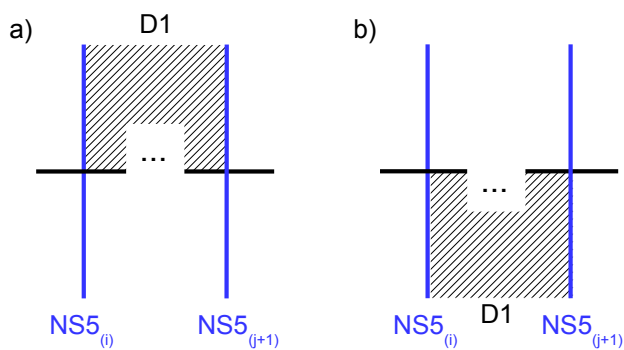

Figure 41. Setups with D1 strings inserting monopole operators. The insertions are: a) $V_{[i;j]}^+$, b) $-V_{[i;j]}^-$. The branes which might stand in the place of the dots “...” insert additional CB operators.

B.3 Mirror Map

From the action of S-duality on the brane setups, one obtains the mirror map between HB and CB operators of a pair of dual theories A and B presented in Table 6 and the map of FI and mass parameters.

Theory A: HB	Theory B : CB
Y_i	φ_i
Z^i_i	$\varphi_{i-1} - \varphi_i$
X_i	$\varphi_{f(i)} - \tilde{m}_i$
$Z^{j+1}_i \quad (i \leq j)$	$V^+_{[i:j]}$
$Z^i_{j+1} \quad (i \leq j)$	$V^-_{[i:j]}$
Theory A: FI param.	Theory B: mass param.
ξ_i	\tilde{m}_i

Table 6. Mirror map of Higgs branch (HB) operators of T_A and Coulomb branch (CB) operators of T_B , and mirror map of FI and mass parameters. $\varphi_{f(i)}$ denotes the scalar of the $U(1)_{f(i)}$ node under with the hyper-multiplet of mass \tilde{m}_i is charged.

References

- [1] K. A. Intriligator and N. Seiberg, *Mirror symmetry in three-dimensional gauge theories*, *Phys.Lett.* **B387** (1996) 513–519, [[hep-th/9607207](#)].
- [2] N. Seiberg and E. Witten, *Gauge dynamics and compactification to three-dimensions*, in *The mathematical beauty of physics: A memorial volume for Claude Itzykson. Proceedings, Conference, Saclay, France, June 5-7, 1996*, pp. 333–366, 1996. [[hep-th/9607163](#)].
- [3] V. Borokhov, A. Kapustin and X.-k. Wu, *Monopole operators and mirror symmetry in three-dimensions*, *JHEP* **12** (2002) 044, [[hep-th/0207074](#)].
- [4] J. de Boer, K. Hori, H. Ooguri and Y. Oz, *Mirror symmetry in three-dimensional gauge theories, quivers and D-branes*, *Nucl.Phys.* **B493** (1997) 101–147, [[hep-th/9611063](#)].
- [5] J. de Boer, K. Hori, H. Ooguri, Y. Oz and Z. Yin, *Mirror symmetry in three-dimensional theories, $SL(2, Z)$ and D-brane moduli spaces*, *Nucl.Phys.* **B493** (1997) 148–176, [[hep-th/9612131](#)].
- [6] A. Hanany and N. Mekareeya, *Complete Intersection Moduli Spaces in $N=4$ Gauge Theories in Three Dimensions*, *JHEP* **01** (2012) 079, [[1110.6203](#)].

- [7] S. Cremonesi, A. Hanany and A. Zaffaroni, *Monopole operators and Hilbert series of Coulomb branches of 3d $\mathcal{N} = 4$ gauge theories*, *JHEP* **01** (2014) 005, [[1309.2657](#)].
- [8] S. Cremonesi, A. Hanany, N. Mekareeya and A. Zaffaroni, *$T_\rho^\sigma(G)$ theories and their Hilbert series*, *JHEP* **01** (2015) 150, [[1410.1548](#)].
- [9] A. Hanany and M. Sperling, *Coulomb branches for rank 2 gauge groups in 3d $\mathcal{N} = 4$ gauge theories*, *JHEP* **08** (2016) 016, [[1605.00010](#)].
- [10] G. Cheng, A. Hanany, Y. Li and Y. Zhao, *Coulomb Branch for A-type Balanced Quivers in 3d $\mathcal{N} = 4$ gauge theories*, [1701.03825](#).
- [11] S. Cremonesi, *3d supersymmetric gauge theories and Hilbert series*, in *String Math 2016 Paris, France, June 27-July 2, 2016*, 2017. [1701.00641](#).
- [12] M. Bullimore, T. Dimofte and D. Gaiotto, *The Coulomb Branch of 3d $\mathcal{N} = 4$ Theories*, [1503.04817](#).
- [13] H. Nakajima, *Towards a mathematical definition of Coulomb branches of 3-dimensional $\mathcal{N} = 4$ gauge theories, I*, *Adv. Theor. Math. Phys.* **20** (2016) 595–669, [[1503.03676](#)].
- [14] A. Braverman, M. Finkelberg and H. Nakajima, *Towards a mathematical definition of Coulomb branches of 3-dimensional $\mathcal{N} = 4$ gauge theories, II*, [1601.03586](#).
- [15] A. Braverman, M. Finkelberg and H. Nakajima, *Coulomb branches of 3d $\mathcal{N} = 4$ quiver gauge theories and slices in the affine Grassmannian (with appendices by Alexander Braverman, Michael Finkelberg, Joel Kamnitzer, Ryosuke Kodera, Hiraku Nakajima, Ben Webster, and Alex Weekes)*, [1604.03625](#).
- [16] A. Hanany and E. Witten, *Type IIB superstrings, BPS monopoles, and three-dimensional gauge dynamics*, *Nucl.Phys.* **B492** (1997) 152–190, [[hep-th/9611230](#)].
- [17] D. Gaiotto and E. Witten, *Supersymmetric Boundary Conditions in $N=4$ Super Yang-Mills Theory*, [0804.2902](#).
- [18] D. Gaiotto and E. Witten, *S-Duality of Boundary Conditions In $N=4$ Super Yang-Mills Theory*, [0807.3720](#).
- [19] S. Cabrera and A. Hanany, *Branes and the Kraft-Procesi Transition*, *JHEP* **11** (2016) 175, [[1609.07798](#)].
- [20] B. Assel and J. Gomis, *Mirror Symmetry And Loop Operators*, *JHEP* **11** (2015) 055, [[1506.01718](#)].
- [21] M. Dedushenko, S. S. Pufu and R. Yacoby, *A one-dimensional theory for Higgs branch operators*, [1610.00740](#).
- [22] J. Gomis and F. Passerini, *Wilson Loops as D3-Branes*, *JHEP* **0701** (2007) 097, [[hep-th/0612022](#)].

- [23] J. Gomis, B. Le Floch, Y. Pan and W. Peelaers, *Intersecting Surface Defects and Two-Dimensional CFT*, [1610.03501](#).
- [24] C. P. Bachas, M. R. Douglas and M. B. Green, *Anomalous creation of branes*, *JHEP* **9707** (1997) 002, [[hep-th/9705074](#)].
- [25] C. P. Bachas, M. B. Green and A. Schwimmer, *$(8,0)$ quantum mechanics and symmetry enhancement in type I' superstrings*, *JHEP* **9801** (1998) 006, [[hep-th/9712086](#)].
- [26] D.-E. Diaconescu, *D-branes, monopoles and Nahm equations*, *Nucl. Phys.* **B503** (1997) 220–238, [[hep-th/9608163](#)].