

LINAC4 TRANSVERSE AND LONGITUDINAL EMITTANCE RECONSTRUCTION IN THE PRESENCE OF SPACE CHARGE

J.B. Lallement, G. Bellodi, V.A. Dimov, A.M. Lombardi, M. Yarmohammadi Satri*,
CERN, Geneva, Switzerland

Abstract

Linac4 is a pulsed, normal-conducting 160 MeV H⁺ linear accelerator presently under construction at CERN. It will replace the present 50 MeV Linac2 as injector of the proton accelerator complex as part of a project to increase the LHC luminosity. The 3 MeV front end, composed of a 45 keV ion source, a Low Energy Beam transport (LEBT), a 352 MHz Radio Frequency Quadrupole (RFQ) at 3 MeV and Medium Energy Beam Transport (MEBT) housing a beam chopper, and the first Drift Tube Linac (DTL) tank at 12 MeV have been commissioned during the first half of 2014. The transverse and longitudinal emittance reconstruction technique in the presence of space charge, which will be used for the next commissioning stages and permanently during the Linac operation, was successfully tested and validated. The reconstruction method and the results obtained at 3 and 12 MeV are presented in this paper.

INTRODUCTION

The Linac4 commissioning started in 2012 at a dedicated test stand [1] where the 3 MeV front-end was installed before it was moved to its final location, inside the Linac4 tunnel, and re-commissioned during the period October 2013 – March 2014. The first tank of the DTL, which accelerates the H⁺ ions beam to 12 MeV, is now being commissioned. Commissioning stages at the energies of 50, 100 and 160MeV will progressively follow.

Temporary measurement benches will be installed after each stage. Two different benches are foreseen: one for the low energy stages (3, 12 MeV) and another for the higher energies (50, 100 MeV). The low energy bench, see Fig.1, houses a slit-and-grid emittance measurement device, a Bunch Shape Monitor (BSM) [2] and a spectrometer magnet. The high energy bench, Fig.2, houses 2 quadrupoles, a BSM, 2 Beam Phase Monitors (BPM) and 3 profile monitors (3 horizontal and 3 vertical Secondary Emission Monitors Grids). The high energy bench comprises neither a spectrometer magnet nor a direct emittance measurement device for the sake of compactness. Cross-checks between direct and indirect methods are foreseen at the low energy bench in order to validate the design of the high energy bench. In particular the cross-checks of the direct and indirect method to obtain the transverse and longitudinal emittance of the beam are the main subject of this paper.

* Home institute : IPM, Teheran, Iran

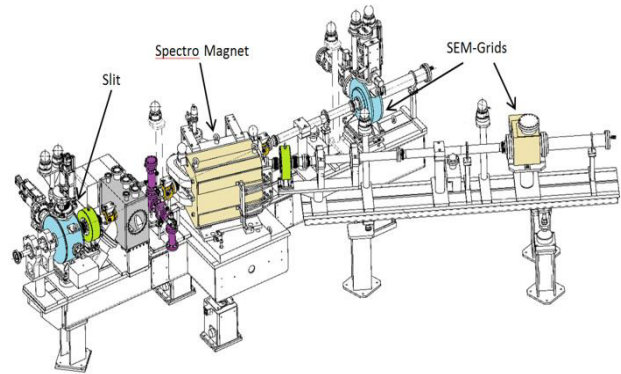

Figure 1: The low energy diagnostic bench.

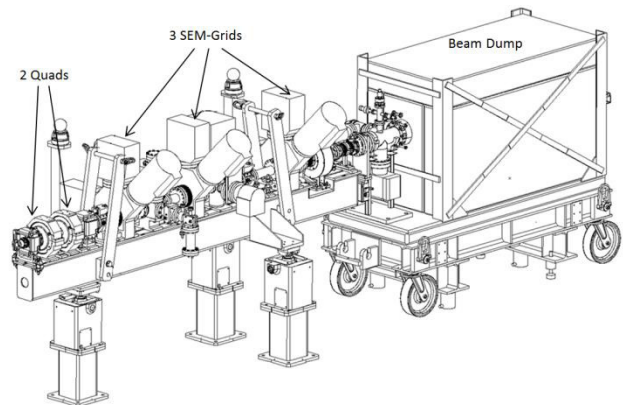

Figure 2: The high energy diagnostic bench.

THE FORWARD METHOD

The forward method is a technique which aims at reconstructing the emittance of a particle beam from profile measurements in presence of space charge [3]. It can be used both in the transverse and the longitudinal planes. For sake of clarity we will explain in detail the case of transverse emittance reconstruction.

The forward method consists of two steps as it combines a classical reconstruction technique [4] and an iterative process based on multiparticle code simulations.

In the first step, the beam size is measured at different locations with profile monitors, at least three, ideally separated with drift spaces with no focusing element in between. The beam size can also be measured on a single profile monitor with three different settings of an upstream quadrupole with well known transfer function. The transport matrices from the reconstruction point (quadrupole for the three-gradient method, first profile monitor for the three profiles method) to the profile monitor(s) being known, the emittance ϵ , and the Twiss



parameters α and β can be found by solving the system of 3 linear equations given by the 3 measurements. This method is fairly accurate provided that the emittance is constant between the quadrupole and the monitors and that the self-forces are negligible. In the presence of space charge, the latter condition is not satisfied, and this dependence can lead to a substantial error in the emittance estimation. A second step is therefore needed in order to take the space charge forces into account while reconstructing the emittance.

The second step consists in simulating the section of the line used for the measurement (from the quadrupole to the profile monitor or from the first to the last profile monitor) with a multiparticle tracking code that includes the space charge forces [5]. An input beam distribution is first generated with the Twiss parameters found at the first step and tracked through the line. The resulting beam sizes from this first run are compared to the one measured and the input beam Twiss parameters are statistically varied within a defined range before a second run. This loop is repeated until the value of the simulated and the measured beam size converge to a precision set by the user. Once the convergence is reached, the resulting input beam parameters are the reconstructed emittance with space charge effects.

The same method can be applied in the longitudinal plane provided that we can obtain a measurement of the micro-bunch phase distribution under (at least) three beam optics conditions, e.g. by independently varying the phase or amplitude of a well-known calibrated RF cavity upstream.

TRANSVERSE EMITTANCE AT 3 MeV

The transverse emittance was reconstructed after the RFQ using one quadrupole and a profile monitor (wire-scanner) permanently installed in the first section of the MEBT line. This first section is composed of 4 quadrupoles, a buncher cavity and a wire-scanner. The schematic layout is shown in Fig. 3. For the emittance reconstruction measurements, the second quadrupole (Q2) was varied in order to change the beam size and generate a beam waist in both transverse planes at the wire-scanner, located 330 mm downstream.

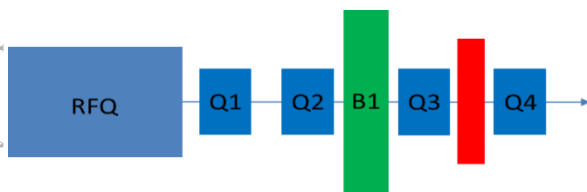

Figure 3: Layout of the first MEBT section (quads in blue, buncher in green and wire-scanner in red).

The measurements results are shown in Fig. 4a for the horizontal plane and 4b for the vertical plane. For different quadrupole settings, the measured rms beam sizes are shown in blue dots, the equivalent beam sizes expected from the simulation in red squares and the beam

sizes after reconstruction in green triangles. We can see that the measured beam size is smaller than what was expected from simulations (beam measured at 45 keV in the LEBT and tracked through the RFQ with Toutatis [6] or Parmteq [7]) especially in the horizontal plane. This translates, after reconstruction, in a smaller resulting emittance. We can also notice the good fitting between measured and reconstructed data which is the result of a good convergence during the iterative process.

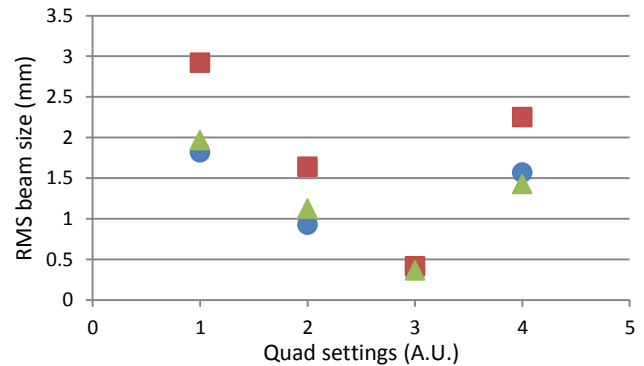

Figure 4a: Predicted (red), measured (blue) and reconstructed (green) horizontal rms beam sizes for different quadrupole settings.

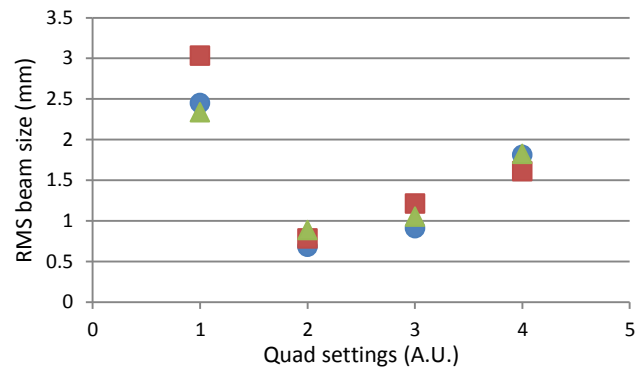

Figure 4b: Predicted (red), measured (blue) and reconstructed (green) vertical rms beam sizes for different quadrupole settings.

The reconstructed normalized rms emittances are equal to 0.31 and 0.34 π mm.mrad in the horizontal and vertical planes respectively, compared to 0.36 and 0.37 π mm mrad from simulations and 0.27 and 0.24 π mm mrad from the direct measurement with the slit-grid system. The smaller values given by the direct measurements can be partly explained by the fact that these are taken after the MEBT conical aperture dump, where around 10% of the outer part of the beam is collimated. During the 3 MeV measurement campaign we also systematically measured smaller beam size on the wire-scanner than is predicted from simulations, which leads to a smaller reconstructed emittance.

LONGITUDINAL EMITTANCE AT 3 MeV

The longitudinal emittance of the RFQ output beam was also reconstructed by applying the forward method. After calibration with beam [8], we varied the voltage of the second MEBT buncher cavity keeping its synchronous phase at -90° . The first cavity settings were unchanged and the third cavity was switched off and detuned during the measurements. The phase spread of the beam was measured with the BSM installed in the diagnostic line after the MEBT. The sketch of the measurement set-up is shown in Fig. 5.

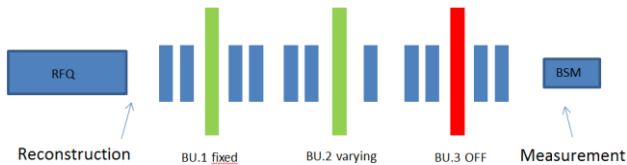

Figure 5: Longitudinal emittance reconstruction setup (quads in blue, bunchers in green and red)

The comparison between the r.m.s. phase spread obtained from the measurement (in blue), the simulation (in red) and the reconstruction (in green) is shown in Fig. 6. Although the measured phase spread is slightly smaller than expected, the beam waist is obtained at the BSM position for the predicted buncher voltage. After reconstruction, we can note a very good agreement between measured and reconstructed data.

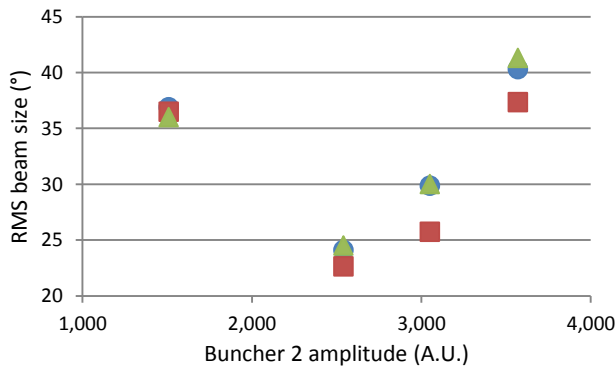

Figure 6: Predicted (red), measured (blue) and reconstructed (green) longitudinal rms beam sizes.

The longitudinal phase space distribution expected from Parmteq simulation and the one obtained after reconstruction are shown in Fig. 7.

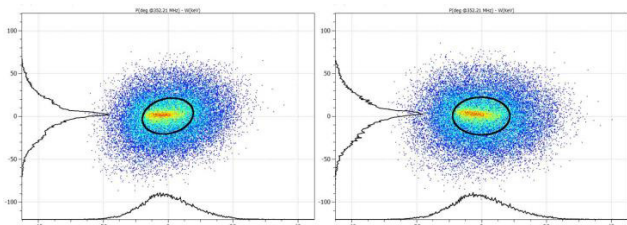

Figure 7: Expected (left) and reconstructed (right) beam distribution in the longitudinal phase space at RFQ output.

The reconstructed rms emittance at the RFQ output is close to the one expected from the Parmteq simulations: 0.19 vs $0.16 \pi \text{ deg.MeV}$. Given the measurement setup which was not optimized for this purpose (the BSM is located 5 meters downstream the RFQ), we can conclude that the agreement with our expectations is good enough.

DISCUSSION

When reconstructing a beam emittance, the choice of the distribution can have a large impact on the resulting values. For the 3 MeV emittance reconstruction, we have used the beam distribution obtained from the multi-particle simulation codes.

During the reconstruction in one of the 3 phase spaces, the input beam parameters (ϵ , α and β) of the 2 other planes should be either the nominal ones from simulation, or the ones resulting from an independent reconstruction if available, in order to simulate a beam volume closer to reality.

CONCLUSION

The “forward method”, a new method to reconstruct emittance from profile measurements in presence of space charge, has been validated at Linac4. This method has been compared successfully to direct measurements both in the longitudinal and transverse plane. This has validated the choice to use this sole method for the next commissioning stages at 50, 100 and 160 MeV and permanently during the Linac4 operation.

REFERENCES

- [1] G. Bellodi et al., “3 MeV Test Stand commissioning report”, CERN-ACC-2013-0259.
- [2] AV. Feshenko, Methods and instrumentation for bunch shape monitor, PAC 2001, Chicago.
- [3] JB. Lallement et al., “Linac4 beam commissioning strategy”, HB2012, Beijing.
- [4] P. Forck, Lecture notes on beam instrumentation and diagnostics, JUAS, 2010, Archamps.
- [5] A. Perrin, J.F. Amand, “Travel v 4.06 user manual”, CERN 2003.
- [6] R. Duperrier et al., “Toutatis, the CEA Saclay RFQ code”, Linac2000, Monterey, USA, 2000. LOCATION.
- [7] KR. Crandall, TP. Wangler, “PARMTEQ-a beam-dynamics code for the RFQ linear accelerator”, AIP, 1988.
- [8] G. Bellodi et al., “Longitudinal beam profile measurements in Linac4 commissioning”, MOPP025, these proceedings, Linac’14, Geneva.
- [9] AM. Lombardi, “commissioning of the low energy part of Linac4”, MOIOA02, these proceedings, Linac’14, Geneva.