

# Operation and performance of the ICARUS-T600 cryogenic plant at Gran Sasso underground Laboratory

---

M. Antonello<sup>a</sup>, P. Aprili<sup>a</sup>, B. Baibussinov<sup>b</sup>, F. Boffelli<sup>c</sup>, A. Bubak<sup>d</sup>, E. Calligarich<sup>c</sup>, N. Canci<sup>a</sup>, S. Centro<sup>b</sup>, A. Cesana<sup>e</sup>, K. Cieřlik<sup>f</sup>, D.B. Cline<sup>g</sup>, A.G. Cocco<sup>h</sup>, A. Dabrowska<sup>f</sup>, A. Dermenev<sup>i</sup>, J.M. Disdier<sup>p</sup>, A. Falcone<sup>c</sup>, C. Farnese<sup>b</sup>, A. Fava<sup>b</sup>, A. Ferrari<sup>j</sup>, D. Gibin<sup>b</sup>, S. Gninenko<sup>i</sup>, A. Guglielmi<sup>b</sup>, M. Haranczyk<sup>f</sup>, J. Holeczek<sup>d</sup>, A. Ivashkin<sup>i</sup>, M. Kirsanov<sup>i</sup>, J. Kisiel<sup>d</sup>, I. Kochanek<sup>d</sup>, J. Lagoda<sup>k</sup>, S. Mania<sup>d</sup>, A. Menegolli<sup>c</sup>, G. Meng<sup>b</sup>, C. Montanari<sup>c</sup>, S. Otwinowski<sup>g</sup>, P. Picchi<sup>l</sup>, F. Pietropaolo<sup>b</sup>, P. Plonski<sup>m</sup>, A. Rappoldi<sup>c</sup>, G. L. Raselli<sup>c</sup>, M. Rossella<sup>c</sup>, C. Rubbia<sup>a,j</sup>, P. R. Sala<sup>n</sup>, A. Scaramelli<sup>n</sup>, E. Segreto<sup>a</sup>, F. Sergiampietri<sup>o</sup>, D. Stefan<sup>n</sup>, R. Sulej<sup>k</sup>, M. Szarska<sup>f</sup>, M. Terrani<sup>e</sup>, M. Torti<sup>c</sup>, F. Varanini<sup>b</sup>, S. Ventura<sup>b</sup>, C. Vignoli<sup>a,\*</sup>, H.G. Wang<sup>g</sup>, X. Yang<sup>g</sup>, A. Zalewska<sup>f</sup>, A. Zani<sup>c</sup>, K. Zaremba<sup>m</sup>

<sup>a</sup>INFN - Laboratori Nazionali del Gran Sasso, Assergi, Italy

<sup>b</sup>Università di Padova e INFN, Padova, Italy

<sup>c</sup>Università di Pavia e INFN, Pavia, Italy

<sup>d</sup>Institute of Physics, University of Silesia, Katowice, Poland

<sup>e</sup>INFN e Politecnico di Milano, Milano, Italy

<sup>f</sup>H.Niewodniczański Institute of Nuclear Physics, Kraków, Poland

<sup>g</sup>Department of Physics, UCLA, Los Angeles, USA

<sup>h</sup>Università Federico II di Napoli e INFN, Napoli,

<sup>i</sup>Institute for Nuclear Research of the Russian Academy of Sciences, Moscow, Russia

<sup>j</sup>CERN, Geneva, Switzerland

<sup>k</sup>National Centre for Nuclear Research, Otwock, Świerk, Poland

<sup>l</sup>INFN Laboratori Nazionali di Frascati, Frascati, Italy

<sup>m</sup>Institute for Radioelectronics, Warsaw Univ. of Technology, Warsaw, Poland

<sup>n</sup>INFN Sezione di Milano, Milano, Italy

<sup>o</sup>Università di Pisa e INFN, Pisa, Italy

<sup>p</sup>Luca Scarcia Company, Italy

\*Corresponding author; e-mail: chiara.vignoli@lngs.infn.it

**ABSTRACT:** ICARUS T600 liquid argon time projection chamber is the first large mass electronic detector of a new generation able to combine the imaging capabilities of the old bubble chambers with the excellent calorimetric energy measurement. After the three months demonstration run on surface in Pavia during 2001, the T600 cryogenic plant was significantly revised, in terms of reliability and safety, in view of its long-term operation in an underground environment. The T600 detector was activated in Hall B of the INFN Gran Sasso Laboratory during spring 2010, where it was operated without interruption for about three years, taking data exposed to the CERN to Gran Sasso long baseline neutrino beam and cosmic rays. In this paper the T600 cryogenic plant is described in detail together with the commissioning procedures that lead to the successful operation of the detector shortly after the end of the filling with liquid Argon. Overall plant performance and stability during the long-term underground operation are discussed. Finally, the decommissioning procedures, carried out about six months after the end of the CNGS neutrino beam operation, are reported.

**KEYWORDS:** Large detector systems for particle and astro-particle physics; Ultra-pure noble liquids; Liquid Argon Detectors; Time Projection Chambers.

---

## Contents

<b>1. Introduction</b>	<b>1</b>
<b>2. Overview of the ICARUS T600 liquid argon TPC</b>	<b>2</b>
2.1 The T600 underground location at LNGS	3
2.2 The T600 cryogenic plant	5
2.3 ICARUS T600 safety equipment, control systems and infrastructures	10
2.4 The slow control system	13
<b>3. Commissioning</b>	<b>14</b>
3.1 Vacuum phase	14
3.2 Cooling phase	15
3.3 LAr filling phase	17
3.4 Detector commissioning and LAr re-circulation and purification start-up	18
<b>4. Cryogenic plant operation and performance</b>	<b>19</b>
<b>5. Decommissioning</b>	<b>24</b>
<b>6. Conclusions</b>	<b>25</b>
<b>7. Acknowledgements</b>	<b>25</b>

---

## 1. Introduction

The ICARUS T600 liquid argon time projection chamber (LAr-TPC) [1] is the largest LAr imaging detector ever built with a total argon mass of  $\sim 760$  t. It was located at the INFN Gran Sasso underground Laboratory (LNGS) with a coverage of 1400 meters of rock. The operational principle of the LAr-TPC [2] is based on the possibility, in highly purified LAr, to transport free electrons from ionizing tracks practically undistorted by a uniform electric field over macroscopic distances. A suitable set of electrodes (wires) placed at the end of the drift path continuously sense and record the signals induced by the drifting electrons. This provides simultaneous projective views of the same event, allowing precise three-dimensional imaging capability [3] and high resolution calorimetric measurements. The design and assembly of the ICARUS-T600 LAr-TPC relied on industrial support and represents the application of concepts matured in laboratory tests to the kton scale.

The T600 was smoothly and safely operated from May 2010 to June 2013, taking data on the CERN to Gran Sasso (CNGS) neutrino beam with extremely high argon purity, stability and detector live-time [1]. It also acted as underground observatory recording cosmic ray and atmospheric

neutrino events. The T600 detector has a unique role since it is presently the largest physics grade operational LAr-TPC and it will remain so for several years to come. It represents the state of the art and it marks a milestone in the practical realisation of any future larger scale LAr detector. The successful operation of the ICARUS T600 LAr-TPC, which allowed to perform a sensitive search for  $\nu_\mu \rightarrow \nu_e$  oscillations [4, 5], demonstrates the enormous potential of this detection technique. The procedures that brought to the activation and operation of the T600 cryogenic plant in a difficult underground environment open the way to larger detector masses (up to tens of ktons) as foreseen by several new neutrino and rare event physics projects.

The ICARUS T600 detector was moved to CERN in 2014 for overhauling. It is expected to be put again in operation at FNAL exposed to the short Booster neutrino beam [6], for a definitive clarification of the observed neutrino anomalies [7, 8, 4] hinting at the presence of a new “sterile” neutrino state. It will also collect a large sample ( $\geq 10^6$ ) of neutrino interactions from the NuMI beam in the few GeV energy domain relevant to the future long base-line experiment [9], allowing detailed study of any event topology and precise tuning of the reconstruction tools. The foreseen LAr program may also pave the way to ultimate realization of the multi kton detector with the precise measurement of the visible energies of both hadron and electron showers and of the muon momentum determination [9, 10, 11, 12, 13].

In this paper the T600 cryogenic plant is described in details together with all the underground infrastructures, as well as the main phases of ICARUS T600 commissioning, which allowed collecting cosmic ray and CNGS neutrino events soon after the detector filling with ultra-pure LAr. Steady state operation is reported focusing on the stability and reliability of the plant. The decommissioning phase is also described.

## 2. Overview of the ICARUS T600 liquid argon TPC

The ICARUS T600 plant [14] consists of a large cryostat split into two identical, adjacent “modules” with internal dimensions 3.6 (width)  $\times$  3.9 (height)  $\times$  19.6 (length) m<sup>3</sup> and filled with  $\sim$  760 tons of ultra-pure liquid argon.

Each module houses two TPC’s separated by a common cathode, with a drift length of 1.5 m. Ionization electrons, abundantly produced by charged particles along their path ( $\sim$  5000 electrons/mm for minimum ionizing particles), are drifted under uniform electric field ( $E_D = 500$  V/cm) towards the TPC anode made of three parallel wire planes, 3 mm apart, facing the drift volume. A total of 53248 wires are deployed, with 3 mm pitch, oriented on each plane at a different angle ( $0^\circ$ ,  $+60^\circ$ ,  $-60^\circ$ ) with respect to the horizontal direction. Wires are made of AISI 304V stainless steel with a diameter of 150  $\mu$ m and maximum length of 9.42 m for the horizontal wires or 3.77 m for the inclined ones. The wire-frame mechanics is based on the innovative concept of variable geometry design consisting in movable and spring-loaded frames to set the proper tension of the wires after installation for precise detector geometry and planarity, to compensate for possible over-stress during the cooling-down and liquid argon filling phases and to counteract the flexibility of the frame. This design demonstrated its reliability, since none of the wires broke and no damages at the wire chamber structure occurred during the 2001 test run, the transport of the two modules from Pavia INFN Laboratory to LNGS, the installation movements on site, the commissioning phase at LNGS and all the successive operations.

By appropriate voltage biasing, the first two wire planes (“Induction-1” and “Induction-2”) provide signals in non-destructive way; finally the ionization charge is collected and measured on the last plane (“Collection”). The relative time of each ionization signal, combined with the electron drift velocity information ( $v_D \sim 1.6 \text{ mm}/\mu\text{s}$ ), provides the position of the track along the drift coordinate. Combining the wire coordinate on each plane at a given drift time, a three-dimensional image of an ionizing event can be reconstructed with the remarkable resolution of about  $1 \text{ mm}^3$ .

A special feed-through flange<sup>1</sup> for the wire signals has been adopted in the T600 detector. It is based on multilayer printed circuit boards where the electrical contacts are ensured by blind holes realized staggering successive printed circuit boards (PCB) layers. The absence of through-going holes ensures perfect tightness for Ultra High Vacuum (UHV) applications. This design was successfully tested in the WARP experiment [15] at LNGS showing high reliability. A set of 96 flanges, holding 576 channels each, was installed on the T600 during detector reassembly at LNGS.

The read-out electronic chain was designed to allow continuous read-out, digitization and independent waveform recording of signals from each wire of the TPC. Organized in 96 crates placed on top of the detector cryostat, it provided wire biasing, hosted the front-end amplifiers and performed 16:1 channel multiplexing and 10-bit ADC digitization at 400 ns sampling time per channel. The electronic noise achieved with the custom designed low noise front-end was  $\sim 1500$  electrons r.m.s. to be compared with  $\sim 15000$  free electrons produced by minimum ionizing particles in the 3 mm wire pitch ( $S/N \sim 10$ ).

The absolute time of the ionizing event was provided by the prompt VUV (128 nm) scintillation light emitted in liquid argon ( $\sim 5000$  photons/mm for minimum ionizing particles) and measured through arrays of Photo Multiplier Tubes (PMTs) coated with VUV sensitive wavelength-shifter (Tetra-Phenyl-Butadiene, TPB), placed in LAr behind the wire planes. The PMT system, used also for internal trigger purposes [16], allowed for a precise measure of neutrino velocity with CNGS beam [17, 18].

Liquid argon purity is a key issue for the LAr-TPC. LAr electronegative impurities (mainly  $\text{H}_2\text{O}$ ,  $\text{O}_2$ ,  $\text{CO}_2$ ) must be kept at a very low concentration level (less than 0.1 ppb), to allow “unperturbed” drift of ionization electrons from the point of production to the wire planes. To this purpose the ICARUS Collaboration developed a successful technique based on the use of commercial filters, carefully selected among the many availabilities on the market and operated directly on liquid and the adoption of ultra high vacuum materials and techniques. The commissioning procedures included an initial vacuum phase followed at regime by the continuous argon re-circulation and purification of both the liquid bulk and the top gas phase.

Additional details on the T600 detector design and construction can be found in [14]; initial detector operation and performance at LNGS exposed to CNGS neutrino beam and cosmic rays are described in [1].

## 2.1 The T600 underground location at LNGS

The ICARUS T600 plant and its dedicated technical infrastructures were installed in the Northern-end side of the Hall B of the underground LNGS Laboratory (Fig. 1, Fig. 2). The final design of the

---

<sup>1</sup>Proprietary technology from INFN.

apparatus was strongly affected by strict requirements on efficiency, safety, seismic constraints and reliability for long time operation in a confined underground experimental area at 1400 m depth. Further severe prescriptions arose from the specific position of the Laboratory along a 10.5 km long highway tunnel with the access in the middle of the tunnel. Additional restrictions came from the LNGS Laboratory location inside a National Park and from the proximity of a public aqueduct.



**Figure 1.** The ICARUS T600 plant in the Northern side of the Hall B at LNGS. Ladders to access the intermediate and the top levels are visible in the front together with the 3 m high wall that separates the T600 area from the rest of Hall B. Cabinets with the readout electronics are visible at the intermediate level. At the top level, the two 30 m<sup>3</sup> cryogenic storage tanks and some additional electronic equipments (HV supply, PMT electronics, trigger system, etc.) are also visible. Most of the cryogenic equipment (nitrogen and argon pumps, cryo-coolers, etc.) is located on the rear side of the T600, at the Northern end of the Hall B.

The T600 plant occupied about 10 × 22 m<sup>2</sup> surface, while the whole “ICARUS Area” in the Hall B was 15 × 42,5 m<sup>2</sup>. This area contained a dedicated service structure surrounding the T600 (about 11 × 36 m<sup>2</sup>) organized in three levels (floor level, 5 and 10 m height) in order to maximize the use of available space in the semi-cylindrical hall. It hosted two 30 m<sup>3</sup> horizontal cryogenic liquid storages (top level), the nitrogen re-liquefaction apparatus (rear floor) and most of the ICARUS auxiliary systems. The ICARUS Area was served by the two Hall B cranes (40 t and 5 t). The apparatus was placed on 28 dampers to fulfill the seismic requirements of the Gran Sasso region. As a reference, the 5.8 Richter magnitude earthquake occurred in the L’Aquila region in 2009 did not produce any appreciable effects on the T600 plant. The ICARUS Area, adequately equipped with a fine grid of sensors to promptly detect any presence of liquids, oxygen deficiency and temperature decrease, was separated from the rest of the Hall B by means of a 3 m high wall for safety reasons. A capillary fast extraction aspiration from ground to protect plant and personnel

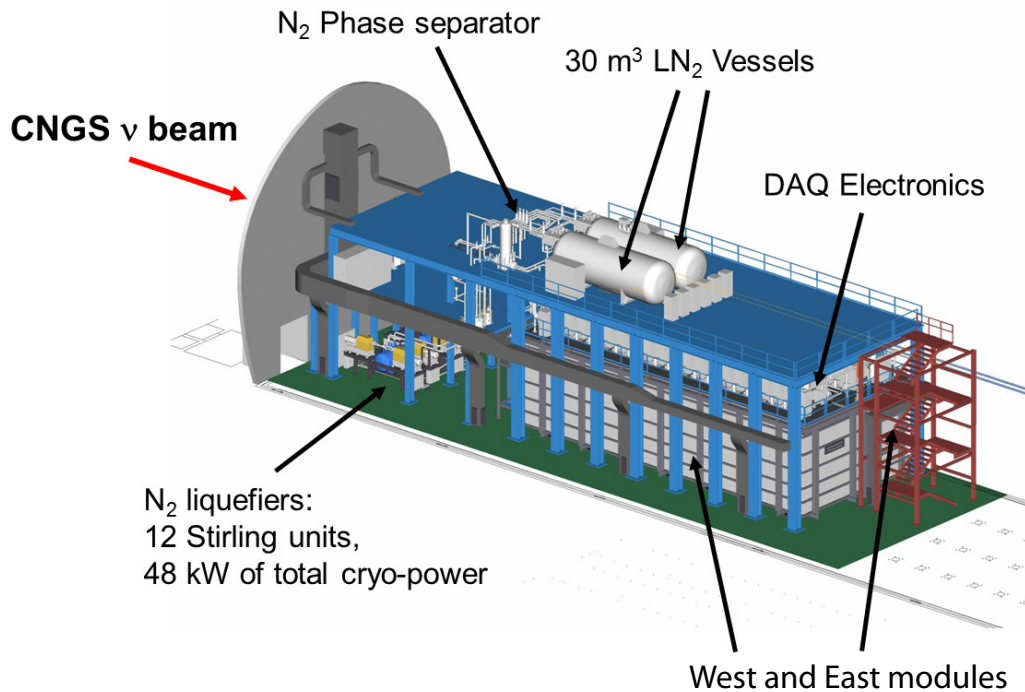

**Figure 2.** Schematic view of the whole ICARUS T600 plant in the Hall B at LNGS.

in case of cryogenic liquid and cold gas spillages, as well as many other safety sensors such as fire and smoke monitors were also installed. The ICARUS Control Room, which hosted all the data acquisition systems and the remote controls of the cryogenic plant and of the detector, was located on the Southern side of the Hall B.

Most of the infrastructures and auxiliary systems were specifically developed for the T600 operation at LNGS, such as redundant power supply sources and distribution systems, uninterrupted power supply for cryogenic plant and detector control systems, upgraded and redundant cooling water system and the nitrogen re-liquefaction plant.

## 2.2 The T600 cryogenic plant

To achieve the physics goals of the ICARUS experiment, the T600 design had to fulfill several strict requirements in terms of detector mechanics precision and stability, electronic noise, argon purity and cryogenic plant performance and reliability. The main technical specifications for the T600 cryogenic plant were:

- an extremely high liquid argon purity in terms of residual contamination of electronegative molecules such as water, oxygen and carbon dioxide (better than 0.1 part per billion) to allow ionization electrons to drift over long distances (meters);
- a fast cooling from room to liquid Ar temperature to minimize outgassing and obtain a good initial liquid argon purity while guaranteeing a temperature difference within each detector

component within prescribed limits ( $\Delta T < 50$  K on the wire-chamber structures,  $\Delta T < 120$  K on the cold vessels) to preserve the high precision detector mechanics;

- a very high temperature uniformity in steady state conditions ( $\Delta T < 1$  K in the whole liquid argon volume) to guarantee the uniformity of the electron drift velocity;
- low and stable thermal losses to reduce operation costs and minimize the power request in emergency situations;
- a very high stability and operation reliability to fulfill the strict underground safety requirements;
- a full redundancy of the relevant elements to guarantee uninterrupted operation over several years;
- no electronic noise or vibration introduced on detector by cryogenic plant dynamic components operation;
- a redundant cryogenic containment for safety aspects;
- an availability of spares components to guarantee long term operation.

The common denominator of the overall ICARUS T600 construction was the partnership with industry based on the achievements and technical developments from the long ICARUS R&D experience with different prototypes [19, 20, 21] and the use of commercial solutions available on the market, when possible. Industry involvement was crucial in order to perform a scaling-up of the technology from the laboratory prototypical scale to the kton one. In particular the T600 cryostat design and construction was carried out in strict collaboration with Air Liquide Italia Service (ALIS) Company<sup>2</sup>.

Safety requirements for underground run implied major changes and improvements with respect to the operational conditions carried out during the surface test in the Pavia INFN Laboratory in 2001 [14]. In particular new solutions for cooling and insulation systems were adopted [22]. The final T600 design at LNGS was further conditioned by the choice of building major components outside the tunnel to work in a more effective and comfortable way and to reduce interferences with other activities and experiments running underground. Schematic views of the T600 plant at LNGS are shown in Fig. 2 and Fig. 3. In the rest of the paper we describe in details only the relevant innovations of the cryogenic plant while for the unchanged components we refer to [14].

The two T600 modules were independent from the point of view of LAr containment and purification plants (Fig. 4) while the nitrogen cooling system and the thermal insulation were common to both. The two modules were aluminum parallelepiped containers, each one with an internal volume of 275 m<sup>3</sup> and 4.2 h × 3.9 w × 19.9 l m<sup>3</sup> external dimensions, had the maximum size allowed for transportation into the LNGS underground laboratory. In the following they will be referred as West module - the one already commissioned in 2001 in Pavia and widely characterized [23, 24, 25, 26, 27, 28] - and East module (the CNGS beam was arriving from the North, Fig. 2). Each cold vessels was realized with 15 mm thick aluminum honeycomb panels linked to

---

<sup>2</sup>[www.airliquide.it](http://www.airliquide.it)



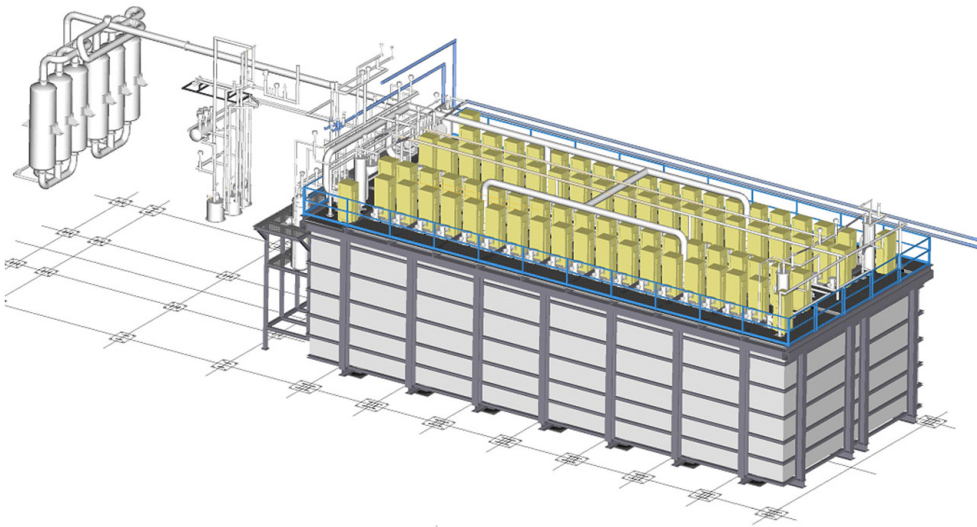

**Figure 3.** Schematic view of the T600 cryostat with representation of the electronic racks and gaseous argon re-circulation systems on the top, the liquid nitrogen circulation pumps and liquid argon re-circulation systems in the rear side. The major safety equipments are visible: the vent line with the electrical heater connected to all the possible exhausts and the collecting pipes from the T600 modules and insulation vessel safety disks to the six passive heater system.

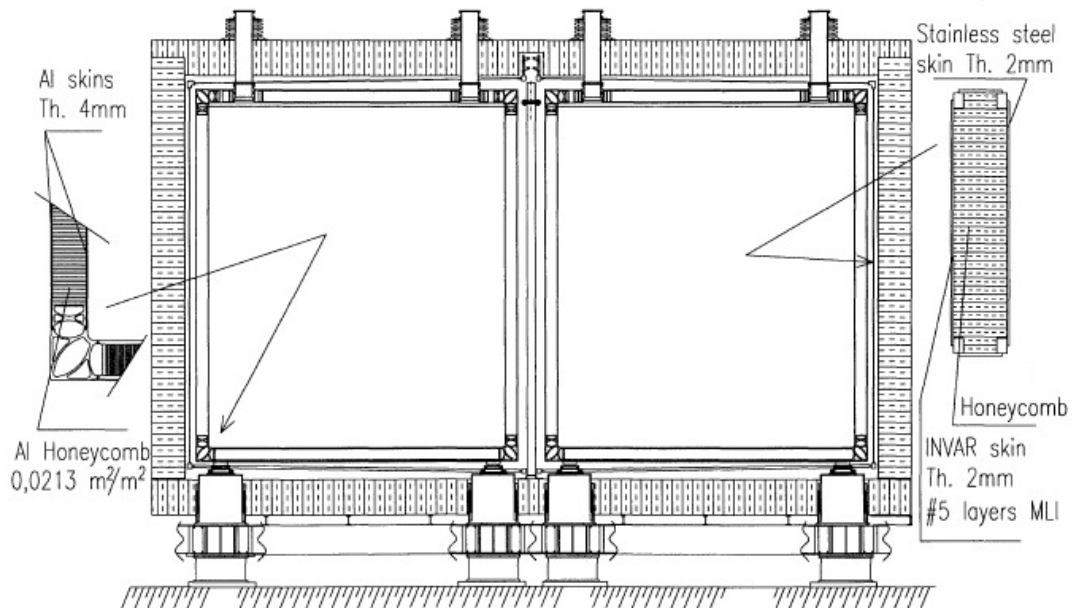

**Figure 4.** Vertical cross section of the ICARUS T600 cryostat.

Al skins and to extruded profiles at the borders with the external and internal skins acting as double cryogenic containment for safety. This unconventional vessel solution was adopted mainly for

lightness request for transportability, rigidity to stand stresses during the evacuation phase and the overall LAr and detector weight during steady state [14].

The T600 thermal insulation was a single vessel surrounding the two modules and designed to behave as an additional container for safety in case of cryogenic liquid spillages. Insulation vessel walls, with the exception of the roof, were made of metallic boxes filled with insulating honeycomb panels (0.4 m thick of Nomex<sup>TM</sup> or equivalent material) and super-insulation layers placed on the internal (cold) surface [22]. The outer skins of the boxes were made of stainless steel while the inner and side skins were of Pernifer<sup>TM</sup> to avoid thermal shrinking. Each compartment was designed to be operated in vacuum to reduce gas conduction and convection (limited by the honeycomb cell geometry but still present due to residual gas) while radiative losses were suppressed by the super-insulation layers, resulting in an overall heat load around 10 W/m<sup>2</sup>. They were intended to be evacuated only once down to 10<sup>-4</sup> mbar and then kept in static vacuum conditions by means of getter pumps. However various difficulties introduced by the large wall dimensions together with an excessive outgassing of the internal honeycomb surface (mainly water) were faced during the construction and mounting of the insulation vessel preventing to reach the nominal design parameters<sup>3</sup>. As a consequence, during cryostat operation, insulation walls were maintained under dynamic evacuation and their internal pressure was continuously monitored for safety reasons.

Holes for pipes and chimneys for cables of the detector signals were all located on the ceiling of the insulation vessel matching the position of all feed-throughs on the two module ports. Special bellows mounted around all the crossing tubes ensured the proper tightness of the box. An external metallic cage placed on an anti-seismic shock-absorber system reinforced the insulation box guaranteeing stress distribution in case of internal overpressure and proper performance for residual accelerations during earthquake events. It supported all the weight of the electronic racks present on the T600 top.

A cooling shield for nitrogen circulation was placed between the insulation vessel and the aluminum containers to intercept the residual heat losses through the insulation walls thus avoiding the boiling of the LAr bulk. Circulation of 2-phase nitrogen, with its latent heat, was chosen instead of under-cooled single phase liquid with much lower specific heat as used in Pavia test run. This new solution allowed using lower power circulation pumps and guaranteed fast cooling-down phase while guaranteeing thermal gradients within specification. Moreover it forced de-stratification of LAr during normal operation maintaining uniform and stable temperature in the LAr bulk. For safety reasons the cooling shield was designed to operate also with liquid nitrogen circulation driven by gravity without the necessity of a dedicated circulation pump thus ensuring the cooling even in case of emergency situations such as the total lack of power supply.

Each T600 module was equipped with two gas and one liquid re-circulation systems to purify gas top and liquid bulk respectively, in order to be used to reach and maintain the required LAr purity for the physics run. A schematic view of all the argon and nitrogen cryogenic circuits is shown in Fig. 5.

The gas re-circulation system was intended to purify the internal gas phase since the initial filling phase when the outgassing rate was still present (it decreases exponentially with temperature)

---

<sup>3</sup>A mechanical instability problem occurred during evacuation of the Northern insulation wall, causing some domino effects. The North wall was repaired and its internal honeycomb replaced on-site with four closed-cell Divinycell<sup>TM</sup> 0.1 m layers. After this event the North and East insulation walls were left at about ambient pressure.

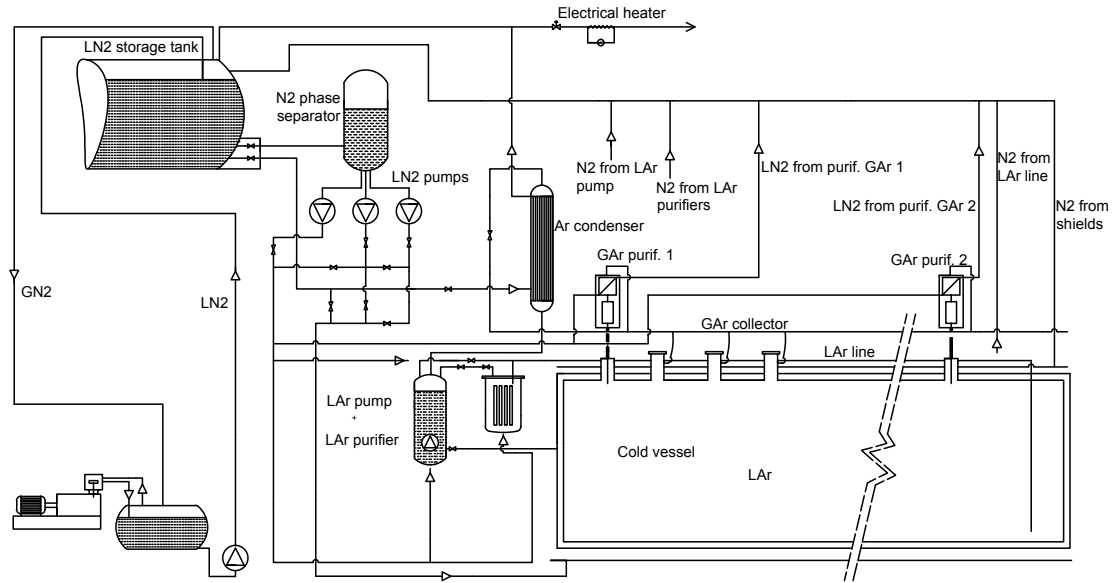

**Figure 5.** Schematic view of the ICARUS T600 cryostat with argon and nitrogen circuits including the implementation of the system to operate in full gravity-driven mode even for GAr re-condensers.

and to act as detector pressure stabilizer during steady state operation. The gas re-circulation units collected Ar gas (GAr) from the chimneys hosting the read-out cables and the feed-through flanges. GAr on the T600 top is warm and dirtier with respect to the liquid, as it is in contact with hygroscopic plastic cables and it could be polluted by possible small leaks due to the presence of several joints on each chimney. The gas was re-condensed and then dropped into a liquid nitrogen cooled Oxysorb™ filter placed below the re-condenser. Finally the purified LAr flowed back into the LAr bulk just below the liquid/gas interface. The condenser was fed with liquid nitrogen at the temperature required for efficient re-condensation of the argon gas, by means of forced circulation. The argon re-circulation rate was normally kept at the maximum rate of 25 GAr Nm<sup>3</sup>/h/unit.

The re-circulation in liquid phase was instead devoted to massively purify LAr and to reach and maintain the highest purity level after the cryostat filling and, in addition, to rapidly restore argon purity in case of accidental pollution during the detector operation. Each LAr re-circulation system extracted LAr at about 2 m below the surface on the 4 m height sides of the T600 modules and injected it on the opposite side, 20 m apart, close to module floor, through a horizontal pierced pipe that ensured a uniform distribution over the vessel width. Each system was equipped with an immersed cryogenic pump (ACD CRYO AC-32 centrifugal pump) placed inside an independent dewar. From the pumps reservoir, the circulated LAr went through a battery of four Oxysorb/Hydrosorb™ filter cartridges (connected in parallel) and was then re-injected into the detector volume. Each set of filters had a nominal O<sub>2</sub> absorption capacity exceeding 200 normal liters, sufficient to purify a module starting from standard commercial liquid argon (O<sub>2</sub> concentration ≈ 0.5 ppm). The maximum re-circulation rate was ≈ 2 m<sup>3</sup>/h, resulting from the pump throughput and the filter battery impedance and corresponding to a full volume re-circulation in about six days. Liquid nitrogen was used to cool the pump vessel, purifier cartridges and all the Ar transfer lines.

Three Barber Nichols external motor centrifugal pumps BNCP-51B-000 model were installed to circulate liquid nitrogen inside the T600 cryostat circuits: one was dedicated to the cooling shield and one to the argon re-circulation systems, while the third one was redundant and ready to start in case of need. Each pump was located inside an independent cryostat fed by gravity from the nitrogen phase separator connected to the main liquid nitrogen storage on the top of the supporting structure. One more extra spare pump was present on site.

The two-phase nitrogen returning from cryostat screens and from the Ar gas and liquid Ar re-circulation system cooling was sent back to the two 30 m<sup>3</sup> liquid nitrogen storages<sup>4</sup> on the top of the ICARUS service structure. For safety reasons connected with the long term operation in underground the T600 nitrogen circuit was designed to work in closed loop by means of a dedicated nitrogen re-liquefaction system. Emergency operation in open circuit was also possible and easily handled in case of prolonged stops of the system provided that liquid nitrogen reservoir was maintained through periodic refill by trucks.

The nitrogen re-liquefaction system was dimensioned to cover the nominal total cold power required for the whole ICARUS T600 plant with at least 50% margin, determined by the design heat load through the insulation (including the heat input through joints, cryostat feet and cables), the foreseen nitrogen consumption for the cooling screen (included the circulation pump and distribution lines) and the Ar gas and liquid Ar re-circulation-purification systems.

The implemented system consisted of twelve Stirling<sup>5</sup> Cryogenics BV SPC-4 (4-cylinder) cryo-coolers<sup>6</sup>, based on the “reverse Stirling thermodynamic cycle”, delivering 4.1 kW of cold power each at 84 K with an efficiency of 10.4% (each unit requires 45 kW power for its electrical motor). This system was organized in 3 skids, each one composed by 4 cryo-coolers and one 1 m<sup>3</sup> reservoir for liquid nitrogen (LN<sub>2</sub>) (Fig. 6).

During steady state the liquid nitrogen tank pressure was kept stable by the re-liquefaction system: the typical working pressure was  $\approx 2.1$  bar abs (corresponding to about 84.5 K temperature) in order to maintain liquid argon at about 87.5 K with an overpressure of about 100 mbar. Nitrogen gas present in the two 30 m<sup>3</sup> LN<sub>2</sub> storage tanks was re-condensed in the 1 m<sup>3</sup> reservoirs and then injected in one of the two 30 m<sup>3</sup> storage tanks by means of two redundant cryogenic transfer pumps (Barber Nichols external motor centrifugal pump BNCP-68-M1 model).

All units operated independently, automatically switching on/off to keep the nitrogen pressure at any given set-point thus delivering the actual cold power needed by the system. This design provided large flexibility in delivering cold power because of its intrinsic factorization; in addition it featured further advantages such as less critical maintenance stops (one unit at the time) without interference with the continuous cooling demand, electrical consumption minimization, easy plant expansion.

### 2.3 ICARUS T600 safety equipment, control systems and infrastructures

The ICARUS T600 detector was equipped with several intrinsic safety systems mainly dedicated

---

<sup>4</sup>In steady state conditions both the 30 m<sup>3</sup> reservoirs were dedicated to nitrogen storage (filled up to about 80 %), while during commissioning one was used for liquid argon.

<sup>5</sup>[www.stirlingcryogenics.com](http://www.stirlingcryogenics.com)

<sup>6</sup>At the time of the commissioning only ten cryo-coolers were installed. The system was later upgraded to guarantee larger redundancy.

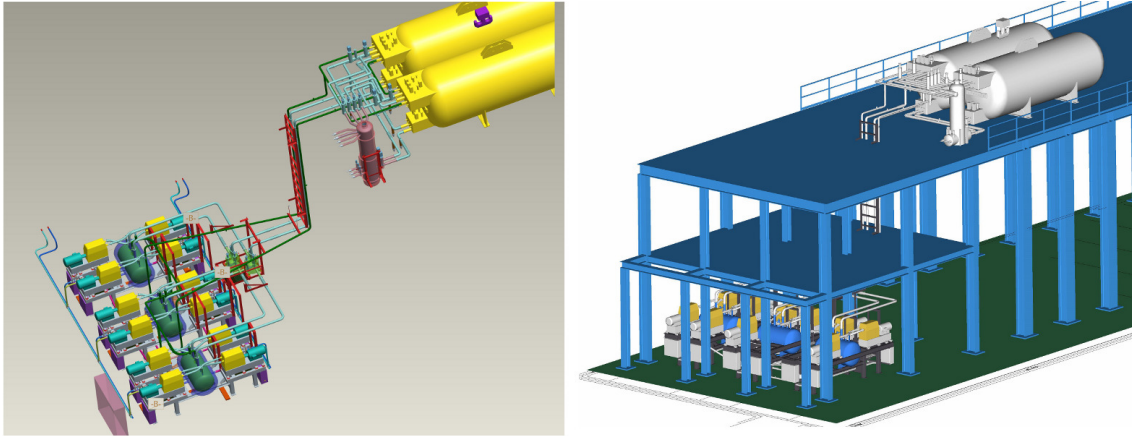

**Figure 6.** Schematic view of the ICARUS T600 LN<sub>2</sub> re-liquefaction system plant composed by the 12 cryo-generators installed on the Hall B floor and the two storage tanks on the top of the ICARUS supporting structure. A dedicated 2 t crane was installed above the skids to ease cryocooler maintenance.

to prevent and eventually confine possible liquid and gas spillages:

- each T600 module was protected by two ADAREG<sup>TM</sup> magnetic disks opening at an internal relative pressure of 0.45 mbar and closing when the relative pressure drops below 0.4 mbar; three manual valves were also installed on three different feed-throughs chimneys. They could be operated manually to lower the pressure;
- the volume between the insulation vessel and the two T600 modules was monitored by temperature sensors and protected by two safety magnetic disks and one safety valve;
- all the magnetic disks outlets were connected to a system of two batteries of three passive heaters (filled by half-rings of Steatite with high thermal exchanging surface) that bring the exhausted argon to room temperature (Fig. 3). A blower and a 10 kW electrical heater were installed to warm-up the saturated battery while the other one was in operation;
- the aluminum honeycomb walls of the T600 modules were monitored and protected against pressure increase;
- redundant safety valves for all the cryogenic tanks and pipes were installed;
- all the possible points of exhaust (safety valves and rupture disks) were collected together into a single vent line to convoy gas to the ventilation extraction port; this vent line was provided with an electrical/pneumatic control to vent at a fixed set point;
- a 50 kW electrical heater (regulated by the temperature at the exit) to warm-up all the cold gas exhaust was put after the discharge valve before the extraction port of the ventilation system in the Northern side of the Hall B, see Fig. 3. The discharge valve plus the electrical heater were used to vent warm nitrogen from the two 30 m<sup>3</sup> tanks in case of emergency when the nitrogen re-liquefaction system was off (open-loop operation) or to vent the transfer line during the liquid refill of the storage vessels.

The whole T600 plant (argon purification and nitrogen circulation systems) and the nitrogen cryo-coolers system, were provided with two local and independent control systems. Both systems were based on widely employed industrial devices (Allen-Bradley for the T600 cryogenic plant and Hitachi for the cryo-coolers). A high level of redundancy was achieved with automatic intervention to guarantee the maximum operational continuity. All the plant parameters of the T600 cryostat were handled by two redundant PLCs (Programmable Logic Controllers) and the critical nodes related to safety were also connected to a third PLC. Automatic process control was developed in order to promptly react to any parameter change or emergency. A common interface based on a SCADA server (iFix Intellution installed on an industrial PC) was also available for higher level, remote, supervision and control system. to record and store all the relevant parameters and events and issue alarms and automatic notifications. It was interfaced with the general LNGS underground Safety Control Room.

The ICARUS Area was equipped with several safety sensors and devices, also monitored with the same SCADA supervision system:

- 13 temperature sensors (PT100 heads with range from  $-50^{\circ}\text{C}$  to  $+150^{\circ}\text{C}$ ) located near the floor all around the T600 plant to detect temperature decrease connected to accidental cold gas or cryogenic liquid leaks;
- 13 oxygen sensors (Draeger-Politron II-O<sub>2</sub>) located near the floor all around the T600 cryostat and the nitrogen re-liquefaction plant, 3 on the other two supporting structure levels and other 4 near the ICARUS Control Room and the cryogenic liquid downloading station, to promptly detect an oxygen concentration decrease due to accidental cold gas or liquid leaks;
- an on-line smoke monitoring system and aspiration ports for each electronic rack;
- an on-line smoke monitoring system in the ICARUS Area for fast fire detection;
- a closed circuit TV system composed by 9 cameras located all around the T600 plant.

All the possible emergency situations were extensively studied and several scenarios were identified and classified in terms of risk level. Significant spillage of cold liquid and/or gas was defined as the most critical scenario (cryogenic emergency). Dedicated infrastructures with high redundancy were implemented for the whole apparatus:

- Hall B air extraction system, to create appropriate differential pressure between the Hall B and the rest of the underground Laboratory. During normal operation, about 7,000 m<sup>3</sup>/h air were inlet in the Southern end of the Hall B and extracted (from bottom and top) in the North end side, maintaining a slight overpressure with respect to the rest of the Laboratory. In case of “cryogenic emergency” the extraction system was set to create in the Hall B a lower pressure with respect to the rest of the Laboratory;
- an emergency extraction system made of capillary pipes extracting gas from the bottom level of ICARUS area and connected to the main Hall B air extraction system. It protected the personnel and the plant in case of cryogenic liquid and cold gas spillages; in this configuration the other extraction ports of the Hall B are closed and the only extraction way is through this emergency system;

- a redundant electrical plant (including a spare source and double distribution line) consisting of a 850 kW electrical cabinet dedicated to the T600 plant and of a second distribution system powered by an independent LNGS cabinet and distributing electrical power to the T600 using an alternative geometrical path in order to enhance reliability;
- an uninterrupted power supply (UPS) for control and safety systems, detector relevant components and for the ICARUS control room;
- a water cooling system to cool the re-liquefaction plant equipped with redundant pumps to enhance water pressure (5 bar). The typical required water quantity per unit was 60 l/min;
- a redundant compressed air system to actuate pneumatic or electro-pneumatic valves. To enhance redundancy an extra compressor ready to start and several nitrogen gas bottles were installed;
- a manually activated diesel generator covering the base electrical power needs of the cryogenic plant (for valves, sensors, controls, electrical heaters for argon and nitrogen exhaust, nitrogen pumps, insulation vacuum pumps).

#### **2.4 The slow control system**

The behavior of the two T600 modules was continuously monitored during the whole critical phases of evacuation, cooling and filling with liquid Ar, through the survey of dedicated sensors, installed in each module for this purpose:

- 8 sensors to measure the module inner wall displacement during the vacuum phase and 10 potentiometric linear sensors to monitor the mechanical behavior of the insulation walls under differential pressure and thermal gradients;
- 4 sensors to control the rotation speed and the adsorbed current of the 4 turbo-molecular pumps used during the vacuum phase;
- 2 internal pressure sensors and one external pressure sensor;
- 30 platinum resistors (Pt1000 type in West T600 module and Pt10000 type in the East one) for internal temperature measurement and 40 external platinum resistors Pt1000 located on the outer insulation surface to monitor thermal losses;
- 14 capacitive position meters to measure the movement of the springs, that compensate the thermal contraction of the wires during the cooling phase;
- 16 continuous level sensors to monitor the liquid Ar filling and 20 carbon resistors, acting as level probes, to monitor the final part of the liquid Ar filling and precisely set the final level.

The acquisition and storage of the slow control signals was based on two National Instruments<sup>7</sup> compact Field Point modules, one for each T600 module.

---

<sup>7</sup>[www.ni.com](http://www.ni.com)

### 3. Commissioning

The commissioning of the ICARUS T600 cryogenic plant started at the beginning of 2010 following the same approach adopted in the successful surface test run in 2001 [14], with an extra attention to maximize safety and minimize interference with other underground activities. The procedure consisted in four main subsequent phases: (i) detector volume evacuation, (ii) cryostat cool-down, (iii) liquid Ar filling and GAr purification/recirculation start-up, (iv) LAr-TPC detector commissioning and LAr purification/recirculation start-up. The most critical phases were remotely operated and controlled from the ICARUS Control Room located in the Southern side of Hall B.

A dedicated area to unload cryogenic liquids from trucks was set-up in the Hall B in correspondence of the LNGS Truck Tunnel. Vacuum jacked liquid nitrogen and liquid argon transfer lines were installed from the unloading station to the two storage tanks on top of the ICARUS service structure at a distance of about 80 m.

#### 3.1 Vacuum phase

The adopted strategy to ensure an acceptable initial LAr purity relied on the cryostat evacuation down to a residual pressure of about  $10^{-4} \div 10^{-5}$  mbar to perform an appropriate out-gassing of all the internal walls and detector materials and to remove air pockets in the inner detector structures.

To this purpose, each T600 module was equipped with four identical remotely controlled pumping groups, mounted on four UHV-CF200 flanges on the T600 insulation top. Each pumping system consisted of a 24 m<sup>3</sup>/h primary Varian<sup>8</sup> Dry Scroll DS600 pump, a 1000 l/s Varian Turbo-V 1001 Navigator pump and three electro-pneumatic gate valves (two on UHV-CF200 flanges, one on UHV-CF35 flange), which allowed to intercept the pumping group, isolate the inner volumes and start vacuum phase with only primary pumps. A safety valve was mounted in parallel to each dry scroll pump to prevent air return in case of power failure.

Before evacuation, the tightness of both T600 modules was tested to a moderate internal over and under- relative pressure<sup>9</sup> in order to find and eventually repair major leaks. The commissioning procedure continued with the vacuum pumping of all the volumes to be filled with argon both in liquid and gaseous phase (the main volumes, the purifiers, the argon transfer lines and the recirculation units) in order to remove air and other pollutants. In order to limit vacuum load only to the external skin of the cold vessels panels, the aluminum honeycomb structures of the cold vessels walls were evacuated by means of rotary vane pumps and their pressure was continuously monitored.

The evacuation of the two modules was performed in sequence. In both cases the effective time to reach 0.2 mbar was approximately 30 hours. The turbo-molecular pumps were then switched on to proceed with the high vacuum phase. For both modules a systematic search and repair of leaks resulted in a sudden improvement of vacuum level. Fig. 7 shows the pressure evolution in the two modules during the pumping phase as a function of the effective pumping time.

During the whole vacuum phase a continuous monitoring of the mechanical deformations of the inner walls was carried out by the eight position meters (see Sec. 2.4). As expected from simulations and from the Pavia experience, the walls deformation increased linearly with decreasing

---

<sup>8</sup>[www.varianinc.com](http://www.varianinc.com)

<sup>9</sup>Ambient pressure in the tunnel is about 900 mbar as it is located at the height of about 1000 m above the sea level.



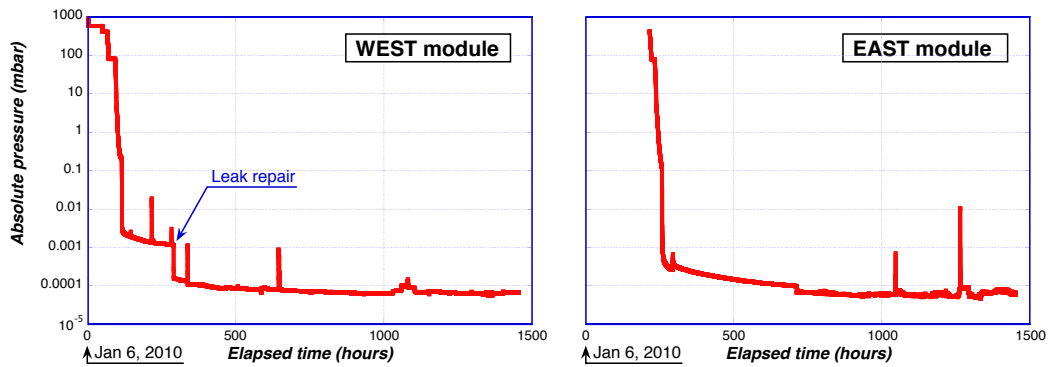

**Figure 7.** Pressure on the West (left) and East (right) modules as a function of the pumping time. The spikes in the plot are due to interventions devoted to leak repair. The large step at about 300 h in the West module is due to the repair of a major leak. Peaks are due to the stop of one of the four turbo-molecular pumps.

pressure and reached a maximum of about 35 mm at the center of the longest vertical walls in both modules.

The target pressure of  $10^{-4}$  mbar was reached in less than three weeks in both modules; then vacuum pumping was continued for a period of three months before starting the cooling phase. The final equilibrium pressure was  $4.5 \cdot 10^{-5}$  mbar ( $3.8 \cdot 10^{-5}$  mbar) for the West (East) module. These values correspond to a global leak rate of about  $6 \cdot 10^{-2}$  mbar l/s ( $4 \cdot 10^{-2}$  mbar l/s), dominated by internal outgassing as verified by measuring the residual gas composition with mass spectrometers installed on two of the top flanges. The measurements showed a 1 ÷ 10 relative content of air to water, showing that outgassing was the dominant source of the residual gas which was expected to freeze on the internal surfaces during the cooling-down phase; contributions from other components were negligible.

### 3.2 Cooling phase

The Stirling plant was commissioned in advance and it had been successfully operating for one year when the cooling phase started. During this period, a series of tests was performed, simulating different working situations, transient phases and cold power requests up to a maximum of 36 kW and demonstrating the correct behavior of the system in agreement with specifications. Failure tests were also successfully performed, including lack of water cooling, power-cuts, liquid nitrogen transfer pump stop.

Immediately after vacuum pumping was stopped, the two T600 modules were loaded with ultra-pure gas argon (Ar N60:  $< 0.5$  ppm  $H_2O$ ,  $< 0.1$  ppm  $O_2$ ,  $< 0.3$  ppm  $N_2$ ) at 100 mbar overpressure, to minimize back-diffusion of air from residual leaks. Then  $LN_2$  circulation started inside the cooling screens using nitrogen from the 30 m<sup>3</sup> storage tank. Both forced and gravity driven circulations were successfully tested and operated. A constant overpressure of 100 mbar was maintained by means of continuous injection of purified gas argon in both modules. Cryostat internal pressure, cryostat wall displacement, temperature gradients on the wire chambers, insulation external temperatures and displacement were monitored.

During the cooling phase, all cryo-coolers were fully active and able to handle most of the

nitrogen evaporation, which was partially exceeding the re-condensation power only during the beginning of the cooling of the 100 ton mass of the metallic containers. The residual nitrogen vapor was warmed-up through the 50 kW electrical heater and safely evacuated from Hall B via the ventilation system. The cooling phase lasted about eight days, reaching 90 K at an average rate of about -1 K/h. The cooling was slowed-down when required to keep the internal temperature gradients on the wire chambers within specifications (50 K). Fig. 8 shows the temperature trend on the wire chambers structures of the West and East modules; the wiggles on the cooling trends are due to the stops of the liquid nitrogen circulation that were used to keep the thermal gradients within specifications. The total LN<sub>2</sub> consumption was only 55,800 l, to be compared with an estimate of 200,000 l required in case of full open loop.

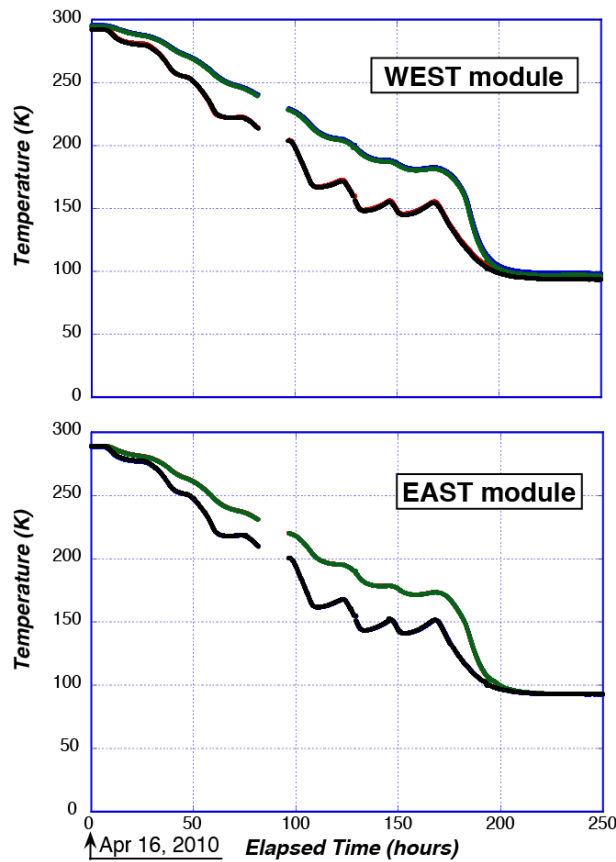
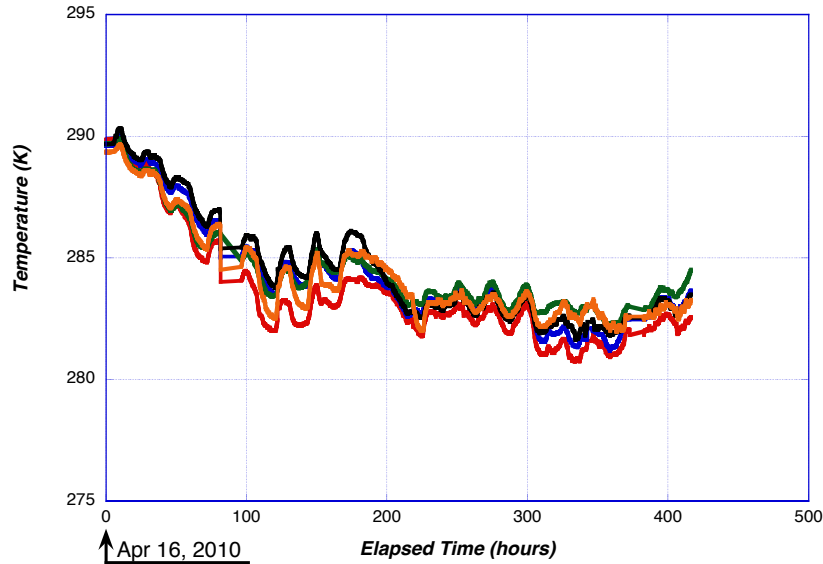

**Figure 8.** Internal temperature trend on the wire chambers structures in the West (top) and East (bottom) modules as a function of time along the whole cooling phase. The values of two temperature probes (out of 15) for each wires chamber are shown, one on the top and one on the bottom of the structure.

After the conclusion of the cooling phase, when the stabilization of the system was achieved and with nitrogen re-condensation system off, the power consumption (insulation losses, plus feet, pipes, cables, chimneys heat input) was determined to be 24 kW in total (corresponding to about six active Stirling units), well within the capability of the re-liquefaction system with all the cryogenic plant activated. The specific contribution to the heat losses of the thermal insulation was estimated to be  $\sim 20$  kW as derived from the temperature differences with respect to ambient air measured

on the outer skin of the insulation panels (see Fig. 9).

The insulation bottom panel resulted within specifications with an internal working pressure of the order of  $10^{-4}$  mbar.



**Figure 9.** Temperature trend of Pt1000 probes located on the outer skin of the insulation vessel: South (red), West (blue and green), East (black and pink). Temperature values stabilization were  $282\text{ K} \div 284\text{ K}$  while the difference with ambient value was about  $-7\text{ K}$ .

### 3.3 LAr filling phase

To ensure filling without interruptions, one of the  $30\text{ m}^3$  tanks was used as LAr storage buffer, continuously feeding the purification cartridges of re-circulation systems of the two modules.

A dedicated cryo-cooler (Stirling Cryogenics BV 1-cylinder SPC-1 500 with a nominal cold power of  $1\text{ kW}$  at  $77\text{ K}$ ) was installed on the liquid argon tank only for the commissioning phase with the aim of stabilizing the argon pressure by means of re-condensation.

Each liquid argon delivery ( $13\text{ m}^3$ ), certified to be within purity specifications ( $\text{H}_2\text{O} \leq 1\text{ ppm}$ ,  $\text{O}_2 \leq 0.5\text{ ppm}$ ,  $\text{N}_2 \leq 3\text{ ppm}$ ), was downloaded into the LAr  $30\text{ m}^3$  vessel. An additional buffer tank ( $1.3\text{ m}^3$ ) was installed at the liquid argon unloading station, to keep the  $80\text{ m}$  long LAr transfer line cold and to preserve argon quality between two consecutive deliveries.

A filter composed by a standard Oxysorb<sup>TM</sup>/Hydrosorb<sup>TM</sup> cartridge with high purification capability was put at the outlet of the  $30\text{ m}^3$  vessel, to avoid early saturation of the T600 main purification cartridges. The liquid argon quality was monitored on-line at the  $30\text{ m}^3$  storage inlet and downstream this filter by means of a gas chromatograph. On average, a typical contamination of  $30\text{ ppb}$  in oxygen and  $100\text{ ppb}$  in nitrogen<sup>10</sup> after the additional filter was measured.

<sup>10</sup>Initial nitrogen content in LAr was not removed by means of the ICARUS purification system. Even if nitrogen is not electro-negative, it has to be maintained as low as possible as it affects the scintillation light production, that is fundamental for internal trigger and timing purposes as explained in the following.

To minimize argon pollution due to outgassing from surfaces, T600 filling was performed in the shortest possible time, while avoiding to reach the opening pressure of the magnetic safety disks. Before starting the filling phase, all transfer lines and storage vessels were accurately purged with high quality argon, until the residual oxygen and water content was lower than 1 ppm.

In order to intercept residual outgassing impurities, the four Gar recirculation/purification units were put into operation at the beginning of the filling, at a rate slightly exceeding the nominal value of 25 Nm<sup>3</sup>/hour per unit. To guarantee an internal overpressure, the cryostat filling was started with ultra-pure Ar gas followed by injection of the first 10,000 liters of liquid argon in West module. A similar procedure was followed for the East cryostat.

Few days after, as required to fully thermalize the inner detector structures, the continuous liquid argon filling in both modules started with an overall rate of about 2 m<sup>3</sup>/h. The whole filling lasted about two weeks and was carried out without the need of opening the cryostat exhaust valves. The final level of liquid argon was precisely set at  $3825 \pm 5$  mm from the cold vessels floor by means of the arrays of discrete level meters described in Sec. 2.4, to ensure a safe coverage of the high voltage region of the TPC field cage. The total amount of downloaded liquid argon was 610,511 liters (47 deliveries). In Fig. 10 the liquid argon level trend during filling is shown for both modules, as monitored by the continuous level meters described in Sec. 2.4.

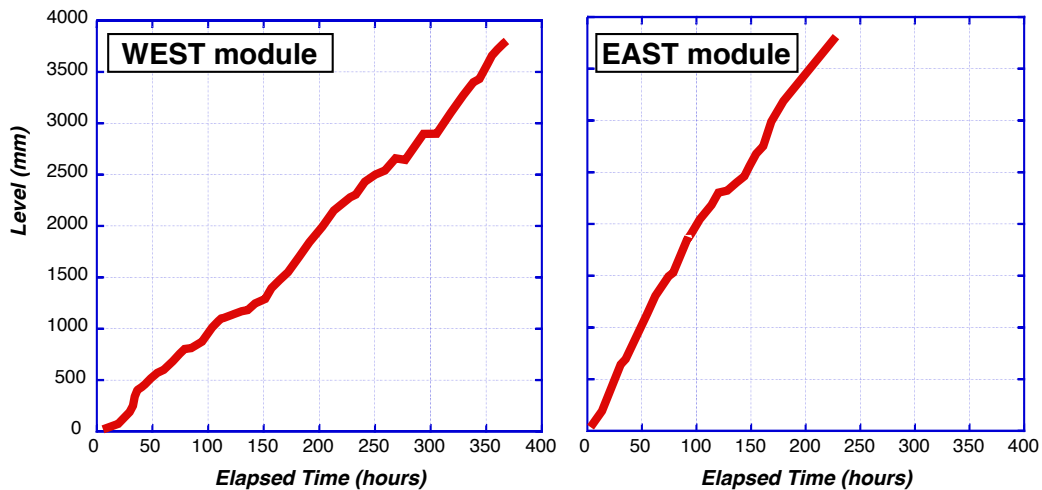

**Figure 10.** Liquid argon level during filling inside West (left) and East (right) modules.

### 3.4 Detector commissioning and LAr re-circulation and purification start-up

After the completion of the cryogenic plant commissioning, the T600 detector steady state working conditions were reached in few days. Soon after, the TPC in the West module was activated by turning on the high voltage biasing system (- 75 kV at the cathode), the data acquisition and PMT trigger system: the first ionization track was immediately recorded and visualized [1].

As already mentioned, the detector cooling and filling procedures did not produce any significant effect on the internal detector structures, the TPC wires and the PMTs. The initial electronic noise level was in agreement with expectations, without detectable microphonic effect due to the cryogenic plant operation.

On May 28<sup>th</sup> 2010 the first CNGS neutrino interaction was recorded (Fig. 11). With uniquely the gaseous re-circulation systems active, the initial free electron lifetime  $\tau_{ele}$  was surprisingly measured with cosmic muon tracks to exceed 600  $\mu$ s, uniform in the whole sensitive volume, corresponding to a liquid argon residual contamination of about 0.5 ppb of O<sub>2</sub> equivalent. Soon after, the East module was activated showing very similar initial performance. The liquid recirculation systems of both modules were also turned on, leading to the steady increase of the LAr purity.

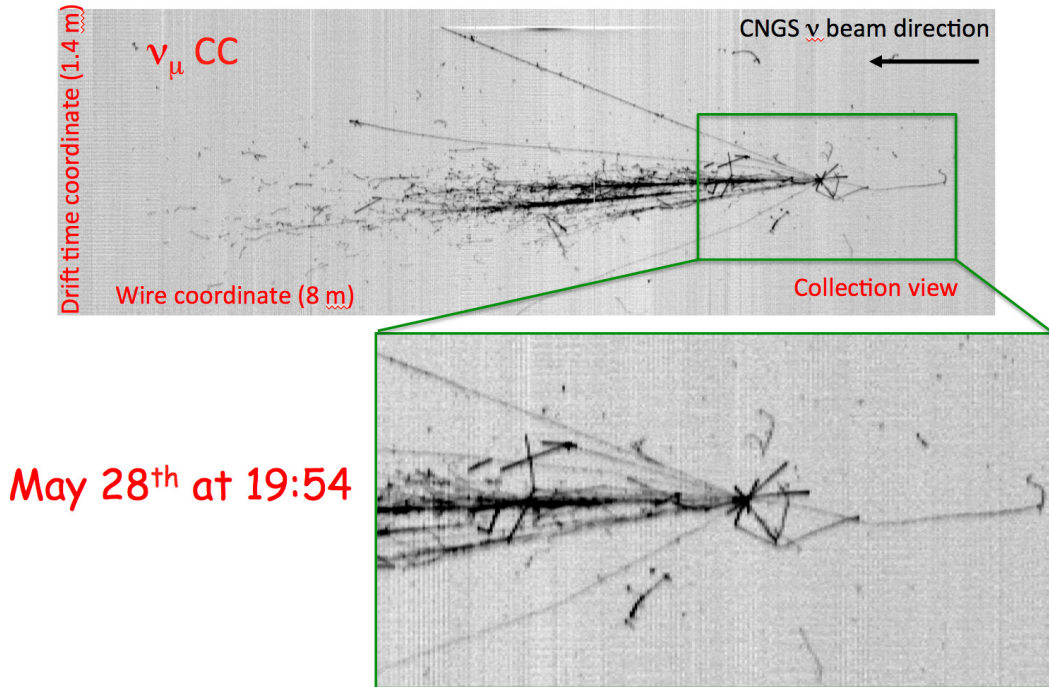

**Figure 11.** First CNGS neutrino interaction observed in the ICARUS T600 detector.

#### 4. Cryogenic plant operation and performance

In the first few months of T600 operation, the whole cryogenic plant was tested, all the regulations fine-tuned and the related parameters were then stabilized. A complete set of tests on possible failures of the apparatus and emergency events were satisfactorily carried out with the automatic intervention of the dedicated backup systems:

- stop of LN<sub>2</sub> circulation pumps, replaced by redundancy or gravity driven operation;
- complete lack of electrical power, replaced by UPS and/or emergency diesel generator;
- lack of compressed air, replaced by operation with nitrogen gas bottles supply;
- failure of the main ICARUS PLC control system, recovered with automatic activation of redundancies;
- cold gas exhaust at the vent to check electrical heater functionality, temperature and oxygen trend at the exit.

Further redundancy and safety systems were afterward implemented including a gravity driven LN<sub>2</sub>/GAr heat exchange system to re-condense the GAr phase, an emergency power line, a fully pneumatic control system to operate valves, to specifically handle the emergency situations of total lack of power in the underground Laboratory.

With all the implemented upgrades and the high intrinsic redundancy, the cryogenic plant was operated safely and reliably during the whole period of steady state T600 run even in case of severe emergency situations without stopping the data taking. The control and supervision systems demonstrated to be extremely efficient allowing adopting a smooth surveillance strategy based on an on-call group of experts intervening underground in case of need. As a result, the few recorded emergency situations, all to be ascribed to external power cuts, were rapidly and successfully handled.

Major attention was dedicated to study the reliability and verify proper redundancy of the involved dynamic components, such as cryo-coolers and pumps, as typically represent the most critical part of a working plant.

The nitrogen re-liquefaction system demonstrated to efficiently cover the maximum T600 cold power request with flexibility and margin. The system design redundancy allowed to perform periodic maintenance to substitute some worn components (in the 3,000 ÷ 12,000 hour range, depending on the device) without affecting the overall refrigeration capacity. After few months of normal operation the average number of active cryo-coolers was found to be  $\sim 9$  and never more than 10 over 12 units (Fig. 12). Periodical measurements on all the cryocooler units allowed to determine the average effective cold power request of about 24 kW in agreement with the initial estimation after the plant commissioning. The observed stability of the cold power request demonstrated that no aging effects or degradations of the thermal insulation performance occurred over the whole three years operation. The liquid nitrogen pumps (Barber Nichols Inc. with external motor) showed an extremely high reliability and stability without interruptions over more than 10000 working hours.

The LAr recirculation system operation was found to be very effective in increasing the LAr purity which was continuously monitored by measuring the electron lifetime in LAr by the charge attenuation along ionizing cosmic muon tracks crossing the full drift volume. About 100 muon tracks were sufficient to measure day-by-day the electron charge attenuation within few percent. The evolution of the residual impurity concentration was described with a simple model including the time needed to recirculate a full detector volume, a constant pollution rate due to external leaks/outgassing in gas phase and the initial contribution of internal residual outgassing which was assumed to vanish with time [1]. Uniform distribution of the impurities throughout the detector volume was also considered, as experimentally supported by the lifetime measurement with muon tracks in different regions of the TPCs [29]. As result a full volume recirculation time of  $\sim 6$  days, in agreement with the nominal pump speed, and extremely low leak rates ( $< \text{few ppt/day O}_2$  equivalent) in both modules were found.

The ACD AC-32 immersed pumps resulted to be less reliable than expected due to excessive bearing case damages that caused frequent system faults with consequent purity drop. A precise and fast intervention procedure was adopted for the LAr pump substitution with a spare one. On average the time interval between two consecutive faults was about 2,000 h.

In spite of the LAr recirculation stops, the impurity concentration was maintained below 0.1 ppb all over the detector run (see Fig. 13). Similar purity trend were observed in both the T600

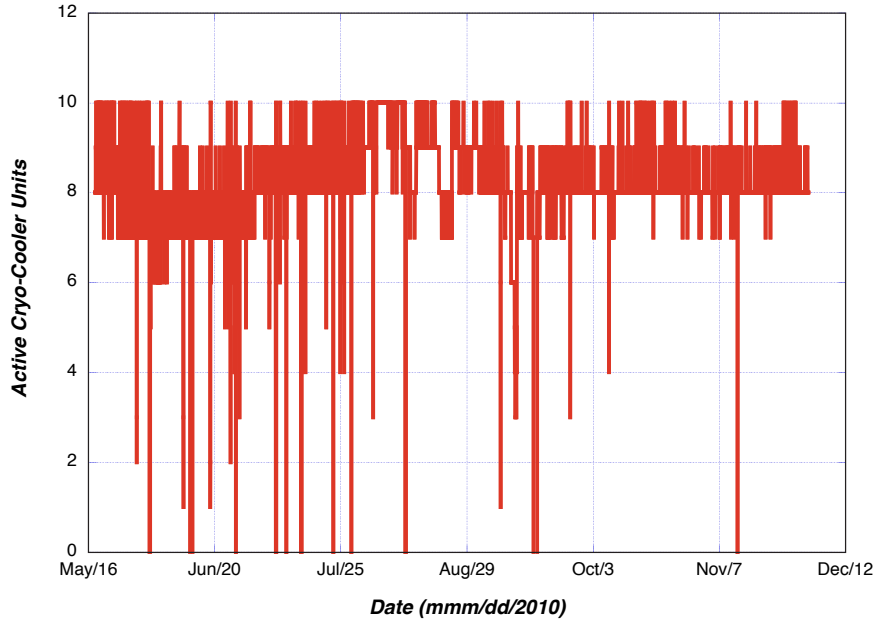

**Figure 12.** Number of active cryo-coolers during the first months of the T600 operation. Some stops of the cooling system are present, due to power cuts or to failure tests.

modules. Electron lifetime values of the order of 7-8 ms were reached in both modules, corresponding to an impurity content of few tens of ppt that imply a maximum attenuation of free electrons of  $\sim 12\%$ .

In order to improve the reliability of the LAr re-circulation system a detailed study was performed comparing the different characteristics and reliability between the ACD immersed pumps used in the LAr circuits and Barber Nichols external motor ones present in the LN<sub>2</sub> transfer lines leading to a significant upgrade of the liquid argon recirculation system achieved in the last few months of detector operation [30]. One of the ACD AC-32 pumps was substituted with a new Barber Nichols BNHEP-23-000 model similar to the other Barber Nichols pumps used on the liquid nitrogen circulation that showed much longer lifetime between ordinary maintenance cycles. The new pump, characterized by magnetic coupling and vacuum housing, was installed inside a new dedicated vacuum insulated cryostat. A LAr/LN<sub>2</sub> heat exchanger was added up-stream of the pump aspiration to under cool liquid argon and to ensure mono-phase liquid state. A Venturi flow-meter was inserted down-stream of the pump output, profiting of the mono-phase argon to measure the flux. After the new pump was switched on, the electron lifetime started increasing at a rate faster than before. At the end of the ICARUS data taking an electron lifetime exceeding 15 ms still rising was measured corresponding to 20 parts per trillion of O<sub>2</sub>-equivalent contamination and an attenuation length of 25 meters, a milestone for any future project involving liquid argon TPC [29]. These results demonstrated the effectiveness of the single phase LAr-TPC detectors paving the way to the

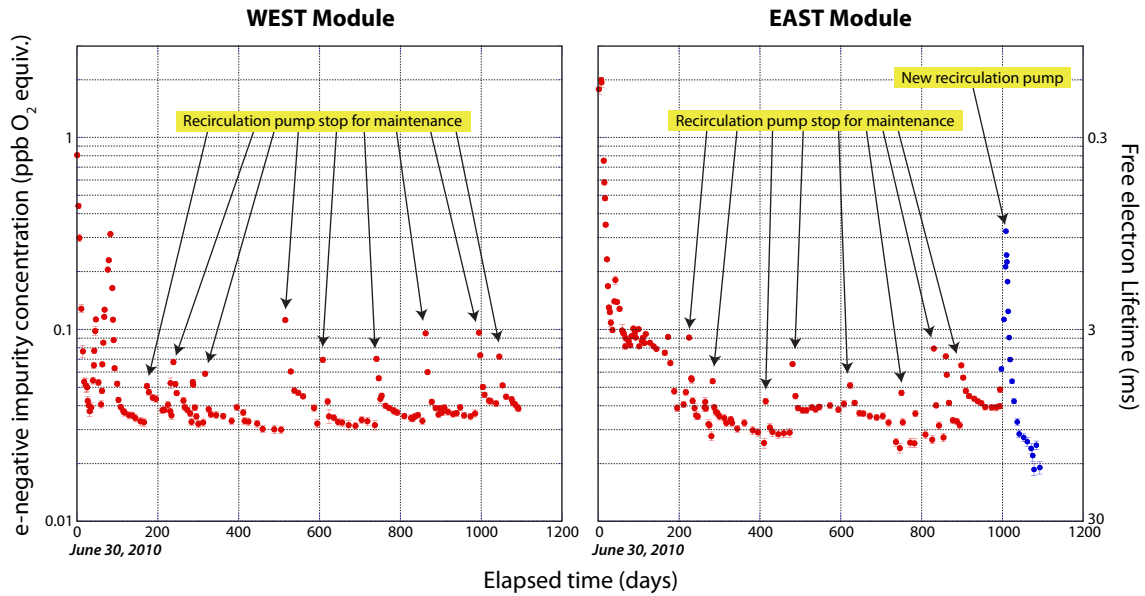

**Figure 13.** Evolution of the concentration of electronegative impurities concentration in the West (left) and East (right) modules as a function of the elapsed time for more than two years of operation of the T600 detector. The corresponding free electron lifetime is shown on the right axis.

construction of huge detectors with longer drift distances. With the achieved purity level only 23% of the signal attenuation is expected at 5 m from the wire planes.

The oxygen contamination contents inferred by the electron lifetime measurements all over the T600 detector run were perfectly compatible with the specifications for untouched scintillation light production and transport [31]<sup>11</sup>. Together with oxygen, also the nitrogen concentration had to be continuously monitored as it was demonstrated that concentrations of few ppms of N<sub>2</sub> strongly quench scintillation light [32] and it couldn't be removed by the ICARUS T600 filtering system. As a consequence a custom set-up based on a commercial mass spectrometer (Pfeiffer QMG 220) was specifically developed to measure nitrogen contamination in Ar. A sample of the T600 gas phase was periodically analyzed and N<sub>2</sub> concentration was always found below the 1 ppm sensitivity of the instrument according to evidence from the PMT signals.

Beside LAr purity, other cryogenic parameters affecting the LAr-TPC performance were accurately monitored along the whole detector operation. In particular, the internal temperature, directly connected to the electron drift velocity, was found stable and uniform to better than 0.25 K (Fig. 14). This was confirmed by the observed stability of the internal absolute pressure (Fig. 15) in spite of the previously mentioned stops and accidents.

<sup>11</sup>O<sub>2</sub> contamination in LAr leads to the attenuation of both the free electron charge (via attachment process) and the scintillation light (via quenching and absorption mechanisms). The request on O<sub>2</sub> concentration to avoid scintillation light reduction is much less stringent than that for electron attachment (effects are visible for concentrations above 0.5 ppm).



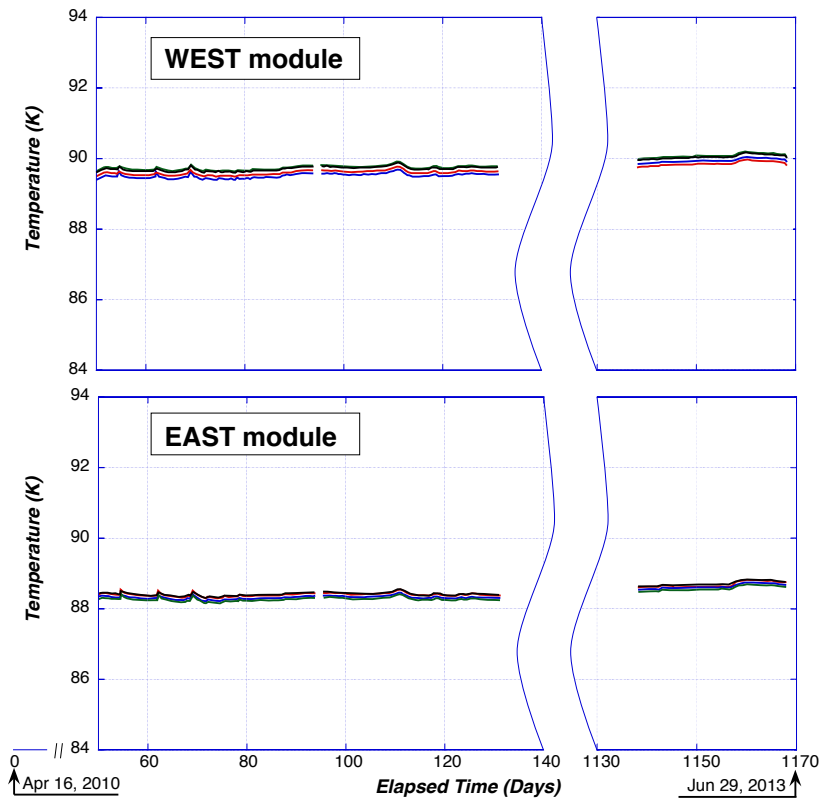

**Figure 14.** Trend of the internal temperatures measured in three different vertical positions (bottom, middle height, top) in the two modules recorded in two periods of the detector live time, one at the beginning of the run, in 2010, and the second in 2013, close to the end of the run.

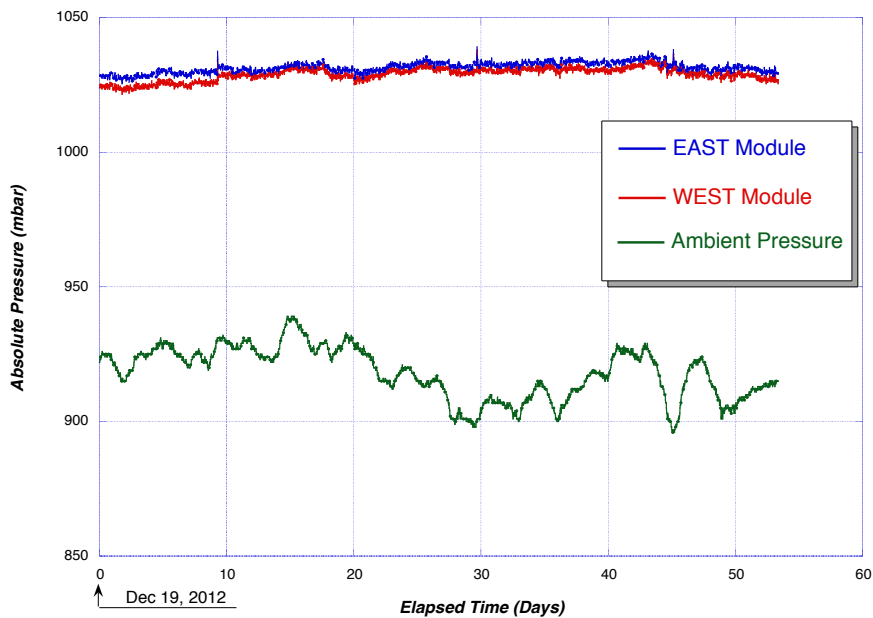
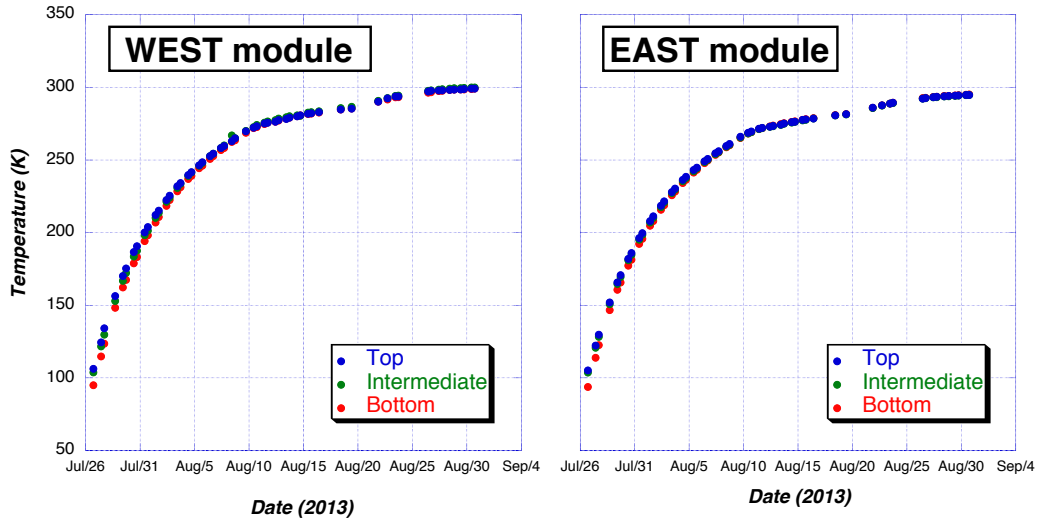

**Figure 15.** Absolute internal pressure in the two modules during a period of about two months between the end of 2012 and the beginning of 2013. The internal pressure was kept uniform and stable within  $\approx 10$  mbar.

## 5. Decommissioning

The preparation for the T600 decommissioning was started during the last months of detector operation. In particular an emptying skid was installed to host an immersed LAr pump, together with an intermediate buffer to speed up the emptying process. The decommissioning process started on June 27<sup>th</sup> 2013 proceeding with the following phases:

1. The cryostat emptying phase lasted less than one month and was operated in a safe and smooth way in parallel on the two modules. To speed up the process, LAr was transferred at 7,000 l/h rate into an intermediate vessel (20,000 l), allowing the decoupling of the emptying procedure from the truck uploading. About 740 LAr tons over a total of 760 were recovered for a total number of 33 trucks (1-2 truck /day).
2. The successive cryostat warming-up started on July 25<sup>th</sup> and took about one month proceeding with the help of a heating system to speed-up the process circulating warm nitrogen gas inside T600 cooling screens while keeping the thermal gradients within the  $\Delta T_{max} < 50$  K specification to prevent thermal shock on wire chambers (Fig. 16).
3. The T600 detector dismantling started in September 2013 and lasted about 15 months. It was finalized to the cryostat opening to extract the TPC detectors as a whole including the light detection system, cabling and ancillary equipments, placed into dedicated boxes specifically designed for the transport to CERN. The cryogenic plant, DAQ and trigger electronic systems were recuperated and separately sent to CERN.



**Figure 16.** Temperature trends on the wire-chamber structure all over the T600 warm-up phase.

## 6. Conclusions

The ICARUS T600 LAr-TPC, installed at LNGS, is the biggest liquid argon detector ever realized and represents so far the state of the art of the liquid argon TPC technology. Industry partnership was crucial to perform a scaling-up of the technology from the laboratory prototypal scale to the kt mass scale.

The commissioning at LNGS was successfully and safely performed during the first half of 2010. The detector smoothly reached optimal working conditions and took cosmic and CNGS neutrino beam data with extremely high liquid argon purity and high detector live-time, performing even beyond expectations. The obtained results demonstrated, as reported in several published papers, the effectiveness of the single phase LAr-TPC detectors paving the way to the construction of huge detectors with longer drift distances.

The three years safe and stable operation in the severe underground environment condition was an important achievement for LAr-TPC technique demonstrating the technology is mature and scalable to several kton mass as required by future projects. Lessons learned from the plant operation, accidental events and plant improvements will be useful for future developments.

## 7. Acknowledgements

The ICARUS Collaboration acknowledges the fundamental support of INFN and, in particular, of the LNGS Laboratory, all the staff and its Directors, to the construction and operation of the experiment. Moreover the authors thank LNGS Safety and Prevention Service, the Research and Technical Divisions, and in particular the Experiment Support Service, the LNGS cryogenic group and the Exercise and Maintenance Service for their contribution to the commissioning and operation of the T600 apparatus. The collaboration recognizes the fundamental involvement of the industrial companies Air Liquide, Stirling Cryogenics BV and Luca Scarcia, which contributed in the realization, operation and maintenance of the cryogenic plant. A special thank to Marco Brugnolli, Arnaldo Di Cesare and Donatello Ciccotti. The authors warmly thank the Electronics Service of INFN Pavia, in particular M.C. Prata, for the design and realization of the slow control electronics and of the vacuum system remote controls. The Polish groups acknowledge the support of the National Science Center, Harmonia (2012/04/M/ST2/00775) and Preludium (2011/03/N/ST2/01971) funding schemes.

## References

- [1] C. Rubbia et al., JINST 6 P07011 (2011).
- [2] C. Rubbia, *The liquid-argon time projection chamber: a new concept for neutrino detector*, CERN-EP/77-08 (1977).
- [3] M. Antonello et al., Adv.High Energy Phys. 2013 (2013) 260820.
- [4] M. Antonello et al., EPJ. C (2013) 73:2599.
- [5] M. Antonello et al. (ICARUS Collaboration), EPJ. C (2013) 73:2345.

- [6] M. Antonello et al., *ICARUS at FNAL*, FNAL/P-1052, arXiv:1312.7252, December 12 2013, M. Antonello et al., *A Proposal for a Three Detector Short-Baseline Neutrino Oscillation Program in the Fermilab Booster Neutrino Beam* submitted to FNAL PAC (January 8 2015).
- [7] A. Aguilar et al., Phys. Rev. D 64, 112007 (2001).
- [8] A. Aguilar-Arevalo et al., PRL 110, 161801 (2013) and references therein.
- [9] Long Baseline Neutrino Experiment (LBNE) Project, Conceptual Design Report, <http://lbne2-docdb.fnal.gov/cgi-bin/ShowDocument?docid=5235&asof=2112-11-06>; LBNE Coll.: *Scientific opportunities with the Long-Baseline Neutrino Experiment*, hep-ex/1307.7335 (2013).
- [10] D. Angeli et al., JINST 4 (2009) P02003; B. Baibussinov et al., *Astroparticle Physics* Vol. 29, Issue 3 (2008) 174.
- [11] A. Rubbia, J. Phys. Conf. Ser. 171 (2009) 012020.
- [12] M. Antonello et al., *Search for anomalies in the neutrino sector with muon spectrometers and large LArTPC imaging detectors at CERN*, ArXiv[hep-ex]:1208.0862v2.
- [13] G. Karagiorgi, J. Phys.: Conf. Ser. 375 (2012) 04206.
- [14] S. Amerio et al., Nucl. Instr Meth. A527 (2004) 329.
- [15] P. Benetti et al., *Astropart.Phys.* 28 (2008) 495.
- [16] M. Antonello et al., JINST 9 (2014) P08003.
- [17] M. Antonello et al., JHEP 11 (2012) 049.
- [18] M. Antonello et al., Phys. Lett. B 713 (2012) 17-22.
- [19] P. Benetti, et al., Nucl. Instr. and Meth. A332 (1993) 395.
- [20] P. Cennini, et al., Nucl. Instr. and Meth. A345 (1994) 230.
- [21] F. Arneodo, et al., Nucl. Instr. and Meth. A498 (2003) 293.
- [22] C. Vignoli, *Advances in Cryogenic Engineering* 51 (2006) 1643.
- [23] A. Ankowski et al., *Acta Physica Polonica B* Vol.41 (2010).
- [24] A. Ankowski et al., EPJ. C 48, 667-676 (2006).
- [25] S. Amoruso et al., Nucl. Instr Meth. A523 (2004) 275-286.
- [26] S. Amoruso et al., EPJ. C 33, 233-241 (2004).
- [27] S. Amoruso et al., Nucl. Instr Meth. A516 (2004) 68-79.
- [28] F. Arneodo et al., Nucl. Instr Meth. A508 (2003) 287-294.
- [29] M. Antonello et al., JINST 9 P12006 (2014).
- [30] C. Vignoli, *Physics Procedia* (2014) in printing.
- [31] R. Acciarri et al., JINST 5 P05003 (2010).
- [32] R. Acciarri et al., JINST 5 P06003 (2010).