

Measurement of spark probability of GEM detector for CBM muon chamber (MUCH)

S. Biswas^{a,b,*}, A. Abuhoza^a, U. Frankenfeld^a, C. Garabatos^a, J. Hehner^a, V. Kleipa^a, T. Morhardt^a, C. J. Schmidt^a, H. R. Schmidt^c, J. Wiechula^c

^aGSI Helmholtzzentrum für Schwerionenforschung GmbH, Planckstrasse 1, D-64291 Darmstadt, Germany

^bSchool of Physical Sciences, National Institute of Science Education and Research, Jatni - 752050, India

^cEberhard-Karls-Universität, Tübingen, Germany

Abstract

The stability of triple GEM detector setups in an environment of high energetic showers is studied. To this end the spark probability in a shower environment is compared to the spark probability in a pion beam.

Key words: FAIR, CBM, Gas Electron Multiplier, Gas gain, Spark Probability, Pion beam, Shower

PACS: 29.40.Cs

1. Introduction

The Compressed Baryonic Matter (CBM) experiment at the future Facility for Antiproton and Ion Research (FAIR) in Darmstadt, Germany, will use proton and heavy ion beams to study matter at extreme conditions and to explore the QCD phase diagram in the region of high baryon densities [1, 2, 3, 4]. This will only be possible with the application of advanced instrumentation, including highly segmented and fast gaseous detectors such as Gas Electron multipliers (GEM) which will be employed in the Muon detector (MUCH) of the CBM experiment [5]. The current design of the muon system consists of 6 iron absorber layers of thickness 20, 20, 20, 30, 35, 100 cm respectively, interleaved with 6 detector stations, which will allow for tracking through the absorber stack. The muon detector in the CBM experiment will be constructed in such a way that there will be micro-pattern gaseous detectors with high rate capability at least in the first 4 stations and other detectors like pad chambers, thick GEM or straw tubes in the later stations [4]. A schematical view of the CBM detector with its MUCH detection system is shown in Figure 1.

Systematic studies on GEM detectors has been performed and published previously [6, 7, 8]. The main goal of this particular study is to measure the discharge probability of GEM detectors [9, 10] in a heavy shower environment that is to be expected for the first stations of the CBM-MUCH. In a dedicated beam time double mask triple GEM detectors were tested at high rate at CERN SPS/H4 with the focus on the spark probability due to slow ionizing particles. To this end a pion beam of ~ 150 GeV was used. Different methods to identify the occurrence of a spark are elaborated and the overall results on the spark probability measurement are presented.

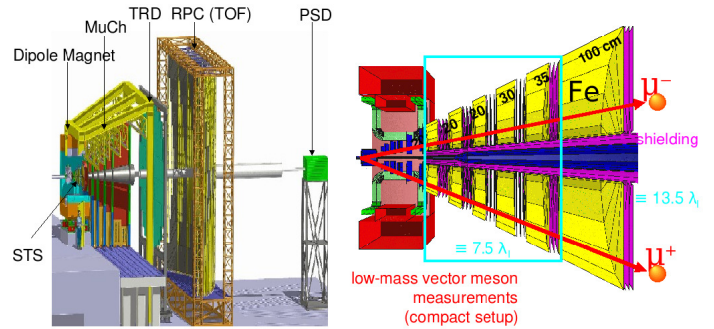

Figure 1: Schematic view of the CBM experiment: Muon set up (left). Implementation of the muon detection system in GEANT (right).

2. Description of the GEM module

In this measurement double-mask GEMs in tripple stack configuration of $10 \text{ cm} \times 10 \text{ cm}$ area were used. The drift gap, the two transfer gaps and the induction gap were kept at 2 mm. The read-out plane consist of 256 pads of $6 \times 6 \text{ mm}^2$ size. All the readout pads were routed to two connectors of 128 pins each. Even though the readout was segmented for the chamber, in this study the signals obtained from all pads were fed into a single channel charge sensitive preamplifier and analyzed with PXI LabVIEW based data acquisition system [11]. During the entire beam time the detector was operated with a premixed counting gas mixture of Argon and CO_2 in 70/30 ratio.

The operating potentials to the GEMs was applied by a seven-channel HVG210 power supply made by LNF-INFN [12]. This module allows for controlling the supply voltages of a triple GEM detector. The module communicates with peripherals via CAN bus. The HVG210 power supply comprises seven almost identical channels, each of them being able to produce a specified voltage level with a current reading and current limiting option. The currents of all channels were recorded and

*Corresponding author

Email addresses: saikat.ino@gmail.com,

s.biswas@niser.ac.in, saikat.biswas@cern.ch (S. Biswas)

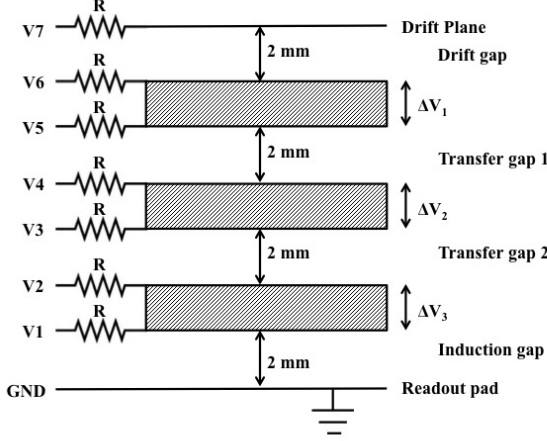

Figure 2: Voltage distribution in GEM.

used to determine the occurrence of a spark. The configuration of potentials in the GEM detector is shown in Figure 2. $11 \text{ M}\Omega$ [R] protection resistors were employed in all the seven channels. The details of the voltages and electric fields in the drift, induction and two transfer gaps are summarized in Table 1 [8].

Table 1: Typical applied voltages and fields on the various gaps of a triple GEM chamber, operated with argon and CO_2 in a 70/30 mixing ratio.

Gap Name	Gap width (mm)	Voltage (V)	Field (kV/cm)
Drift	2	500	2.5
Transfer 1	2	600	3.0
Transfer 2	2	600	3.0
Induction	2	400	2.0

3. Arrangement for beam test

Figure 3 schematically shows the experimental set-up for measurement and identification of a spark due to a shower in the GEM detector using pion beam. Showers are provoked through a 10 cm thick iron absorber placed into the primary beam. Four scintillators, two placed upstream the absorber into the primary beam and another two placed downstream the absorber, laterally shifted away from the beam direction, are used for obtaining a trigger from a shower created in the absorber. The four-fold coincidence between signals from finger scintillators ScF1 and ScF2, and the two scintillators ScM and ScL is used to identify the presence of a shower. Upstream ScF1 and ScF2 two additional scintillator detectors were allocated, whose coincidence signal monitors the rate of the primary beam from SPS. These detectors are referred to as the beam counter. The coincidence count of ScF1 and ScF2 proved to always match with the beam counter from SPS. The GEM-detector under investigation was placed off axis downstream the absorber outside

the primary beam direction such that beam particles not having produced a shower would not go through the GEM-detector. Therefore, only those primary and secondary particles involved in a shower could reach the detector. Such particles are to a large extent highly ionizing particles.

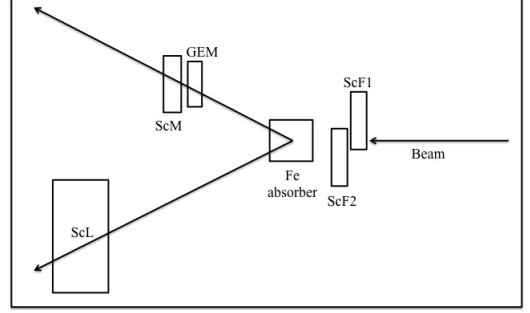

Figure 3: Experimental set-up for the measurement of shower induced sparks. The dimension of the iron absorber was $10 \text{ cm} \times 10 \text{ cm} \times 20 \text{ cm}$. The GEM-detector was placed 16 cm laterally away from the primary beam direction at a downstream distance of 30 cm (entrance window) from the front surface of the iron absorber.

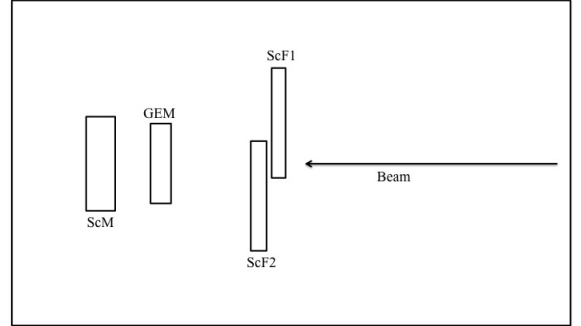

Figure 4: Experimental set-up for the reference measurement of spark probability due to a pure pion beam.

The experimental setup to measure the spark probability for the pion beam is shown in Figure 4. In this setup the three-fold coincidence between signals from ScF1, ScF2, placed in front of the GEM and ScM, placed after the GEM is taken to define a beam particle. In this case all the scintillators and the GEM are aligned with the beam line.

In this set-up the voltage and current from all seven channel of the HVG210, counts from the beam counter, scintillators, GEM detector and the pulse height of the GEM detector has been measured. In the result section we shall discuss only those measurements which are relevant to spark probability measurement.

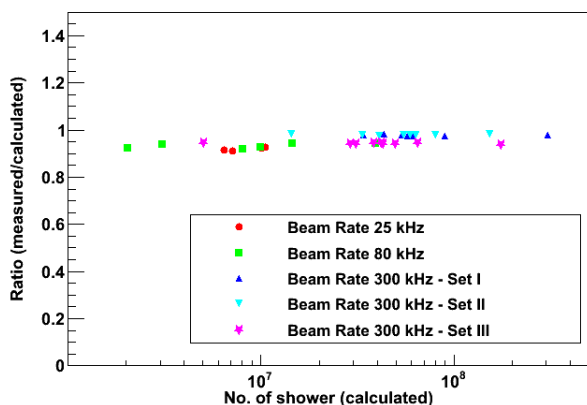

Figure 5: Ratio of experimentally determined shower intensity to FLUKA simulated expectations.

The number of particles produced during shower has been calculated from the exact geometry of the experimental set-up by using FLUKA simulation. From the FLUKA simulation it was found that in the GEM plane the total number of electrons and positrons, neutrons, pions, protons, kaons and muons were respectively 0.8, 0.2, 0.08, 0.04, 0.006 and 0.001 per primary pion. The numbers are compared with the experimental value. The comparison for the different data set is shown in Figure 5. FLUKA simulations have shown that showers hitting the GEM area contain more than 40% slow particles (mainly protons and pions) $\beta\gamma < 2$.

4. Result

4.1. Measurement of current

In this study the current in all the individual channels from the drift plane, and top and bottom surfaces of the three GEM foils has been recorded by the HVG210 power supply. The variation of current during and in between spills in SPS are shown in Figure 6 and Figure 7 respectively for pion beam and shower along with the GEM count rate. In the first case the average pion beam rate is 80 kHz and in the second case i.e., during shower the pion beam rate is 300 kHz. In both cases the voltage setting for the GEM were $\Delta V_1=400$ V, $\Delta V_2=395$ V and $\Delta V_3=390$ V. For 10 cm thick iron absorber around 35% of the pion beam particles produced shower. The SPS has a spill of 10 seconds with an interval of about 30 seconds.

4.2. Measurement of spark probability

The spark probability is defined as the ratio of the total number of sparks produced in the GEM detector to the total number of particles incident on the detector [15, 16].

In this paper two different methods to identify the presence of a spark in the GEM-detector were used. The first one identifies a spark through the absence of a signal, the detector being saturated. The second method identifies the presence of a spark through an enhancement of operating currents. Both

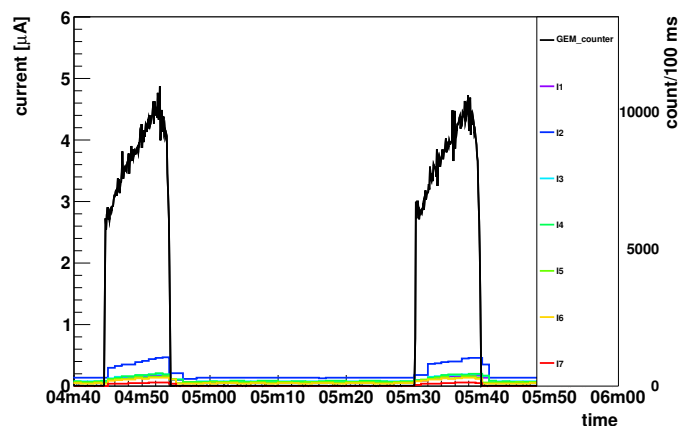

Figure 6: Current and GEM counting rate: Pion beam 80 kHz.

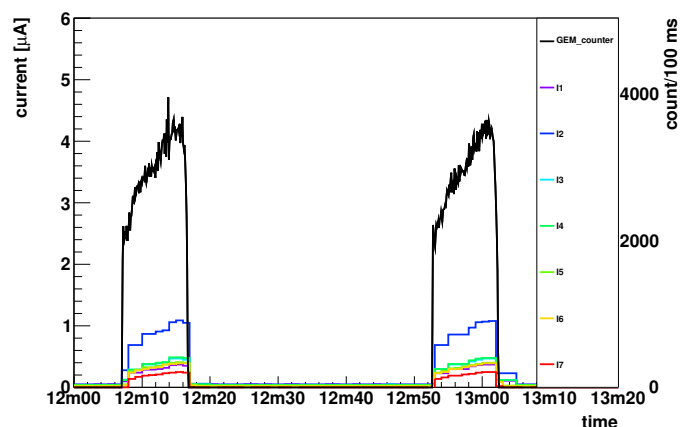

Figure 7: Current and GEM counting rate during Shower: Beam rate 300 kHz.

these methods were experimentally executed in two different ways: Absence of signal was identified through a drop in the count rate on one side and the absence of signals in the pulse height analyzing ADC. The second method through observation of operating currents can identify a spark either through a jump in a particular current or through an internal "spark counter" of the power supply. These methods are discussed in detail in the following paragraphs.

Among these different methods the first and most important one proved to be the identification of a spark from a sudden drop of counting rate in the GEM detector during a spill. During a spark, a sudden drop in the electric field inside a GEM reduces the overall gain and thus the counting rate in the GEM-detector. A situation where the ratio of count rates between GEM-detector and beam counter drops below 20% of its average value is defined as a spark. Different threshold values between 10% and 50% were tested, but no significant change of the results was observed. This definition appears as a rather robust way to identify the presence of a spark in the GEM-detector during a spill and was thus employed for this exper-

imental investigation.

In Figure 8 the black line exemplarily shows the count rate registered by the GEM-detector during a spill. The apparent sudden drop in count rate is used to define the occurrence of a one spark. Even the presence of two sparks during a spill was sometimes observed. Figure 9 shows such an example.

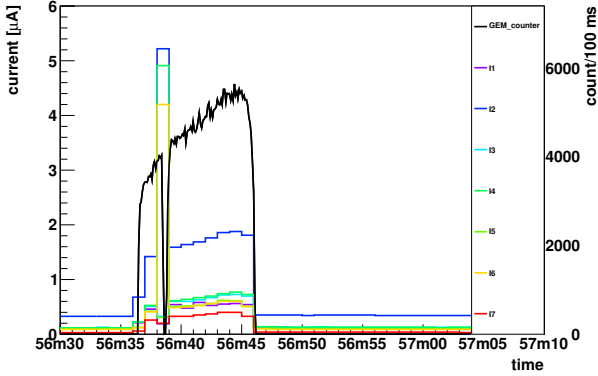

Figure 8: Identification of a spark from a drop in count rate in the GEM during a spill. In parallel, the currents on all GEM-electrodes were registered and are displayed.

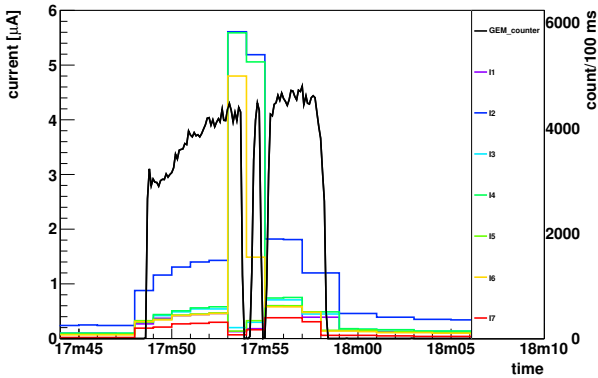

Figure 9: Example of a spill with the occurrence of two sparks.

The second method to determine a spark uses the sampling ADC data. When there is a spark inside the GEM the electric field drops resulting no signal from the GEM. Thus, in case of a spark in the GEM-stack, one should not expect a signal on the ADC channel observing the GEM signal, which on itself is triggered through the coincidence signal of the scintillators. The use of this method depends upon the noise level to be as small as possible and for this reason proved to be much less robust for the identification of a spark.

Measuring the current from the individual channels and observing an increase in the current value particularly from the top of the three GEMs is another way to determine the occurrence of a spark during a spill. The effectiveness can be seen in figures 8 and 9. Whenever there is a drop in the count rate in the GEM-detector, some or all of the current values in the power supply

show a steep jump from their normal values. Thus, the occurrence of a spark can alternatively be determined from such a sudden current increase on any one of the GEM-electrodes. The current threshold in our experiments was set to $4 \mu\text{A}$ to define a spark.

The latter method to detect a spark can be implemented through a built-in feature of the GEM power supply HVG210. The module comprises a special provision called trip checker to count a spark. A current threshold I_{th} can be set together with a time window T_{wnd} and the number of times (N_{ovfl}) the current readings has gone beyond the specified threshold value, so that the module internally registers the occurrence of a spark. With a high current threshold value, a count of the N_{ovfl} yields an estimate the number of sparks that occurred. An increase in N_{ovfl} indicates an increase in the number of sparks. This method has one particular advantage: It yields the number of sparks in a particular supply channel and thus points to the particular GEM foil where the spark occurred.

The determined spark probability as a function of the global GEM voltage ($\Delta V_1 + \Delta V_2 + \Delta V_3$), the sum of the potential differences of every GEM in the stack, is shown in figure 10 (cf. [13, 14]). The measurement was taken with different gas flow rates, 3 lt/hr and 5 lt/hr. In earlier measurements it had been observed that the gain of the detector depended upon the gas flow rate [7]. In this operational global voltage range the gain of the detector was measured to vary between 12000 and 30000. In this figure the spark probability is determined through the first method only i.e. from the drop in the GEM count rate during a spill. In this study the overall spark probability was found to be $\sim 10^{-7}$. The probable reason for this high absolute value is the operation of the GEM-detector at very high gain [17, 18]. Two different measurements i.e. a jump in the current and a drop in the counting rate yield almost identical results. During off-spill the spark probability was practically zero.

The spark probability during operation of the GEM detector in showers does not increase if compared to the operation in a pure pion beam. Thus, in such a relative measurement, relating the susceptibility to sparks in a shower environment to the spark probability in a pion beam, the overall spark probability that may depend upon the experimental particularities, is not that relevant.

The showers apparently really do put some load on the GEM-detector as it is found in FLUKA simulation. This can be confirmed through the higher electrode currents in the stack during a shower. Yet, the spark probability is not compromised through these heavy, highly ionizing showers.

5. Conclusions and outlooks

In this article four different methods for the identification of spark in a GEM detector were elaborated. The spark probability was measured for a pure pion beam as well as a pion beam with 10 cm thick iron brick as absorber. The variation of the spark probability as a function of the global GEM voltage ($\Delta V_1 + \Delta V_2 + \Delta V_3$) has been presented for a shower and for the pion beam. The spark probability increases exponentially with the

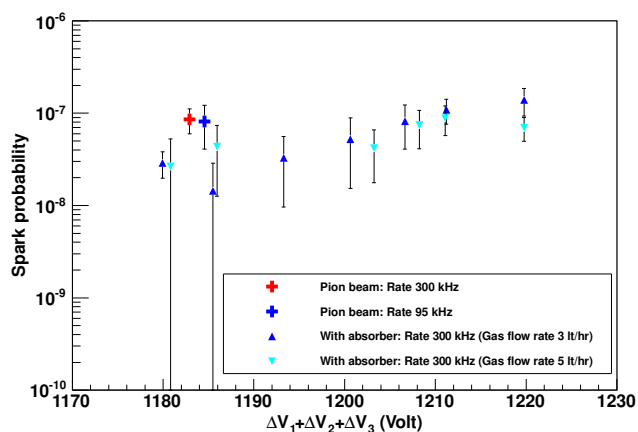

Figure 10: Spark Probability as a function of global GEM voltage.

global voltage. In this study the spark probability was found to be $\sim 10^{-7}$ at the applied voltage settings. A secondary shower does not appear to trigger additional sparks in the GEM detector when compared to a pure pion beam. It is concluded that the presence of slow, heavily ionizing particles contained in showers behind the iron absorbers does not increase the spark probability relative to fast pions. Current measurements on the GEM electrodes show an increase of the current in almost all the electrodes of the stack. The maximum absolute increase in current is observed in the third GEM-foil, where the maximum number of electrons is reached. The foils, in which the spark occurs, can be identified through the separately measured currents.

As an outlook, the measurement will be repeated with 3 mm drift gap and without a current limiting protection resistor at the bottom of the GEMs in future. The effects will be studied and will be communicated at a later stage.

6. Acknowledgements

We are thankful to Dr. Ingo Fröhlich of University of Frankfurt, Prof. Dr. Peter Fischer of Institut für Technische Informatik der Universität Heidelberg, Prof. Dr. Peter Senger, CBM Spokesperson and Dr. Subhasis Chattopadhyay, Deputy spokesperson, CBM for their support in course of this work. We are grateful to Dr. Anna Senger of GSI for the FLUKA simulation results. We would like to thank Jorrit C. L. Widder for his effort during the SPS test beam. We are also grateful to Dr. Leszek Ropelewski and Dr. Serge Duarte Pinto of RD51 for their valuable suggestions. S. Biswas acknowledges the support of DST-SERB Ramanujan Fellowship (D.O. No. SR/S2/RJN-02/2012).

References

- [1] <http://www.fair-center.eu/for-users/experiments/cbm.html>
- [2] <http://www.fair-center.eu/>
- [3] CBM Progress report 2008.
- [4] A. Prakash et al., Di-muon measurements in CBM experiment at FAIR, arXiv:1102.0882 [nucl-ex].

- [5] F. Sauli, Nucl. Instr. and Meth. A 386 (1997) 531.
- [6] S. Biswas et al., Study of the characteristics of GEM for the FAIR experiment CBM, CBM Progress report 2011.
- [7] S. Biswas et al., Nucl. Instr. and Meth. A 718 (2013) 403.
- [8] S. Biswas et al., 2013 JINST 8 C12002 doi:10.1088/1748-0221/8/12/C12002.
- [9] M.C. Altunbas, et al., Nucl. Instr. and Meth. A 490 (2002) 177.
- [10] M.C. Altunbas et al., Nucl. Instr. and Meth. A 515 (2003) 249.
- [11] <http://www.ni.com/labview/whatsnew/>.
- [12] G. Corradi et al., Nucl. Instr. and Meth. A 572 (2007) 96.
- [13] Tom Francke and Vladimir Peskov, Innovative Applications and Developments of Micro-Pattern Gaseous Detectors, Engineering Science Reference (an imprint of IGI Global), Page: 152.
- [14] S. Biswas et al., Spark probability measurements for GEM for CBM. Retrieved, <https://indico.cern.ch/event/184546/session/4/contribution/2/material/slides/1.pdf>
- [15] S. Bachmann et al., Nucl. Instr. and Meth. A 470 (2001) 548.
- [16] G. Bencivenni et al., Nucl. Instr. and Meth. A 494 (2002) 156.
- [17] S. Bachmann et al., Nucl. Instr. and Meth. A 438 (1999) 376.
- [18] S. Bachmann et al., Nucl. Instr. and Meth. A 479 (2002) 294.