

BUNCH COMPRESSOR DESIGN FOR CLIC DRIVE BEAM

A. Aksoy*, Institute of Accelerator Technologies, Ankara, Turkey
D. Schulte, J. Esberg, CERN, Geneva, Switzerland

Abstract

The drive-beam linac which is required for generation RF power at Compact Linear Collider (CLIC) has to accelerate an electron beam with 8.4 nC per bunch up to 2.4 GeV in almost fully loaded structures. The required beam stability in both transverse and longitudinal directions are of concern for such a high bunch charge. We present different bunch compressor designs for the Drive Beam and compare their performance including the effects beam energy and phase jitters.

INTRODUCTION

CLIC [1] is based on a two-beam scheme in which the rf power used to accelerate the main beam (at 12 GHz) is produced by a second beam (the drive beam, DB) running parallel to the main one through so-called Power Extraction and Transfer Structure (PETS). This drive beam has a high current but relatively low energy and is decelerated for producing the rf power. Schematic layout of Drive beam is given with Fig. 1. The CLIC Drive Beam Linac (DBL) will consist of about 750 structures which are low frequency (1 GHz) and will be almost fully loaded transferring more than 95% of their input power to the beam. The average energy gain per structure will be $\Delta E \approx 6.95$ MeV. The initial beam energy is assumed to be $E_0 = 50$ MeV, the final beam energy $E_f = 2.4$ GeV, the bunch charge $q = 8.4$ nC, initial bunch length $\sigma_{z,0} = 3$ mm and the transverse normalized emittances are $\epsilon_{N,x} = \epsilon_{N,y} = 50 \mu\text{m}$ [1].

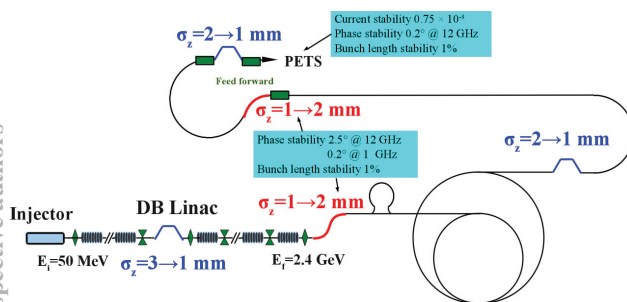

Figure 1: Layout of CLIC drive beam.

In CLIC 1% luminosity loss requires $\delta\sigma_\phi \leq 0.2^\circ$ bunch phase and $\delta\sigma_z \leq 1\%$ bunch length jitter in the PETS [2]. Therefore bunch energy jitter and bunch phase-length coupling in DBL are of concern. If the full bunch compression is performed in front of PETS one needs $R_{56} \approx -60$ cm for a chirp of 0.5% energy spread per 3 mm bunch length. In that case, for getting acceptable beam phase jitter one would need 3×10^{-5} beam energy jitter. In order to avoid the strong coupling between energy jitter induced in the drive

beam accelerator and beam phase jitter transformed in the bunch compressor, we propose that the bunches are accelerated to 300 MeV in first stage of drive beam linac (DBL1) and compressed from 3mm to length of 1 mm, which is the length required in PETS, and then accelerated to their final energy of $E_f = 2.4$ GeV (see Fig. 1).

As it can be seen on Fig. 1 the bunches will be compressed and de-compressed several times on drive beam. However the energy acceptance of circular paths such as Combiner Ring (CR) and Delay Loop (DL) are very tight. Therefore in order to compress or de-compress the bunches with small R_{56} one should obtain proper longitudinal phase space distribution just after the DBL. In this study, two different type of injector based on thermionic gun (similar to CTF3) and photo cathode RF gun have been considered. Additionally four different type of bunch compressor have been taken into account in order to fulfill longitudinal tolerances. For both linac scheme we have used FODO type of lattice since it has good performance against transverse wakefield effects [4].

INJECTORS

Two different type of injector based on thermionic gun and photo cathode gun has been taken into account.

Thermionic Gun Based Injector

Thermionic gun based injector has been studied for long time. The electron current is extracted from a dispenser cathode with a length of $140 \mu\text{s}$, which is essentially the train length. Three sub harmonic buncher (SHB) operating at 500 MHz are used in order to start bunching. A fundamental buncher is followed these SHBs operating at 1 GHz. The bunches are accelerated up to 50 MeV using fully loaded accelerating structures [3]. The layout of thermionic gun based injector is given in Fig. 2.

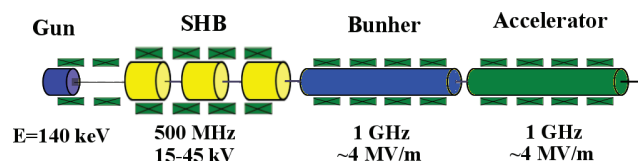

Figure 2: Layout of layout of thermionic gun based injector.

The longitudinal phase space and some parameters of the one bunch after such injector is given in Fig. 3. As it can be seen in the figure the bunch has tails which will probably cause beam loss on drive beam at high energies.

Photo Cathode RF Gun Based Injector

For the photo cathode RF gun option we assumed the bunches are created at cathode with high power laser that

* avniaksoy@ankara.edu.tr

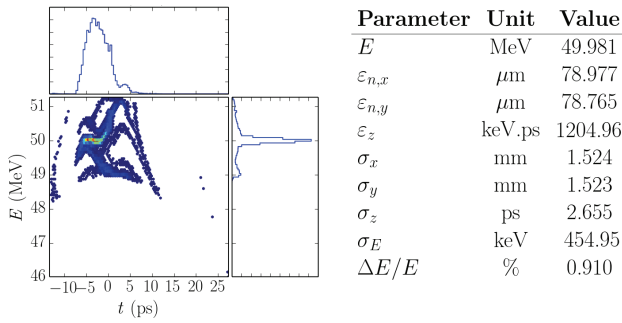

Figure 3: Longitudinal phase space of the bunch after thermionic gun based injector. [3]

has pulse length of 28 ps at FWHM. The gun is followed by CLIC DBL structures (see Fig. 4).

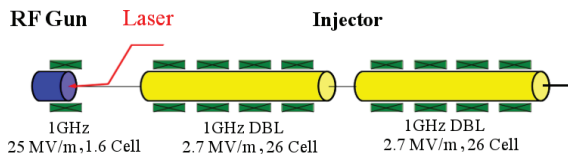

Figure 4: Layout of layout of RF gun based injector.

In order to find out the bunch distribution after such injector we have scaled the geometry of LCLS gun [5] to 1 GHz and used Astra code for tracking along injector. The longitudinal bunch distribution and beam parameter after such RF gun based injector is given with Fig. 5.

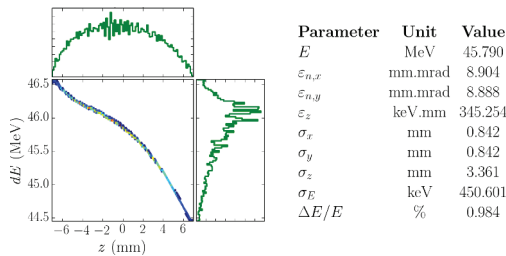

Figure 5: Longitudinal phase space of the bunch after RF gun based injector.

DBL LAYOUT WITH REGARD TO INJECTOR TYPE

The tails as shown in Fig. 3 should be removed when the beam energy is low. Additionally the current distribution along bunch should be optimized in order to reduce the effect of longitudinal wake field. We have proposed a bunch compressor which acts as an energy collimator but does not change the length of bunch. The beam is accelerate further by DBL1 and compressed $\sigma_z = 3\text{mm}$ to $\sigma_z = 1\text{mm}$ by Bunch compressor and accelerated up to 2.4 GeV by DBL2(see Fig.6).

In order to perform a good compression on RF gun based DBL scheme we proposed to use four CTF3 structure as third Harmonic linearizer just before bunch compressor.

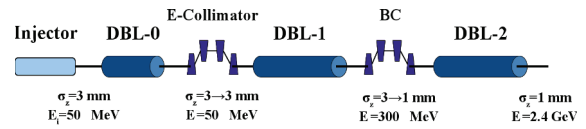

Figure 6: DBL layout with thermionic gun based injector.

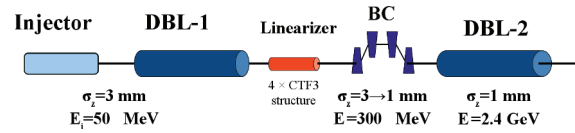

Figure 7: DBL layout with RF gun based injector.

Left hand side of Fig. 8 shows the longitudinal phase space of bunch before and after collimator and right hand side shows the phase space before and after third harmonic linearizer. Similarly left hand side of Fig. 8 shows the longitudinal phase space of at the end of DBL for thermionic gun based injector and right hand side shows the phase space for RF gun based injector.

PERFORMANCE OF BUNCH COMPRESSORS AND PROPOSED SCHEMES

Compressing the bunch before the main part of the acceleration, one can afford having a strong bunch energy chirp and small R_{56} , thus a weak coupling between beam energy jitter and beam phase jitter can be obtained. In the second stage of the drive beam linac (DBL2), the large relative energy spread will be reduced below 0.4% which is acceptable in delay loops, combiner rings and PETS. In order to reduce effect of coherent synchrotron radiation, the bunches are should be uncompressed to 2 mm before they enter the delay loop and re-compressed behind the combiner rings to the final required length of 1 mm. To avoid an energy jitter from DBL2 turning into beam phase jitter the sum of all R_{56} of all elements after DBL has to be zero. Additionally, the bunch compressors (or de-compressors) should have reasonable small R_{56} in order to save space. Thus the energy chirp of bunches should be adjusted properly on all entire system of DBL.

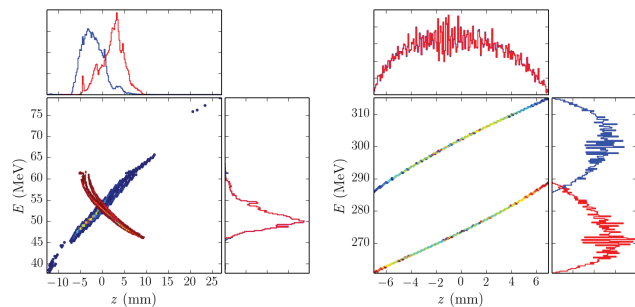

Figure 8: Longitudinal phase space of bunch before and after collimator (left) and before and after linearizer (right).

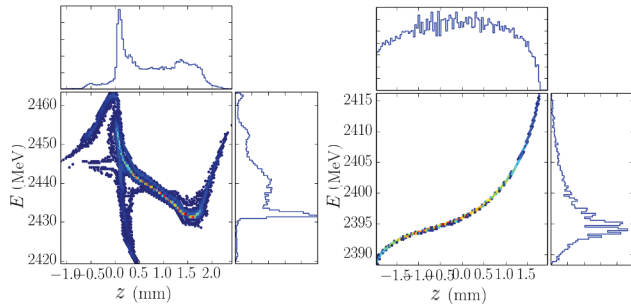

Figure 9: Longitudinal phase space of bunch at the end of DBL for thermionic gun (left) and RF gun (right) options.

Under first order approximation the error of phase ($\delta\sigma\phi$) or error of bunch length ($\delta\sigma$) of a bunch in a magnetic chicane will be proportional of jitter of the energy ($\delta\sigma \approx R_{56}\delta E$). Several quantities that can lead energy jitter can be summarized as ;

- phase error of incoming bunch from injector ($\delta\phi_{bin}$)
- energy error of incoming bunch from injector (δE_{bin})
- gradient error of structures (δG_{RF})
- phase error of structures ($\delta\phi_{RF}$)

The bunch compressor should compensate large errors of these quantities as well as errors caused by beam loading. In order to define longitudinal tolerances we have taken into account single bunch case and studied four types of compressors using the proposed DBL layouts given above. Additionally we assumed that coherent errors which can be the worst case during operation.

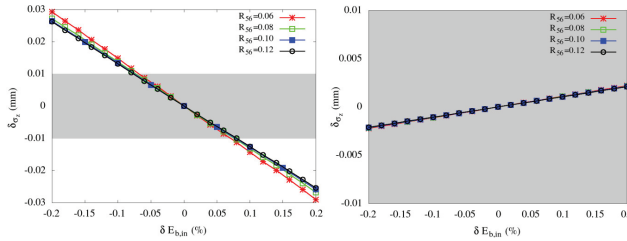

Figure 10: Variation on bunch length versus error of incoming beam energy. Left hand side is for the thermionic gun based DBL and right hand side is for RF gun based option.

Figure 10 shows variation on bunch length versus error of incoming beam energy. As it can be seen on the figure the linac based on RF gun has very large tolerances comparison with thermionic gun based one. Figure 11 shows variation on bunch length versus error of incoming beam beam. Similarly to previous figure the linac based on RF gun has larger tolerance than the thermionic gun based one. Figure 12 shows the bunch length variation versus the error of RF phase. Both linac option has more less tolerances but the tolerance relaxes with decreasing the R_{56} of bunch compressor.

CONCLUSION

In this study we have compared the injectors based on photo cathode RF gun and thermionic gun. As it can be

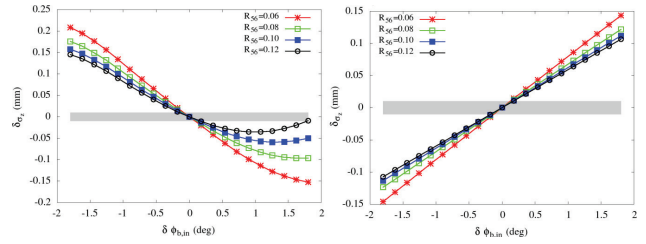

Figure 11: Variation on bunch length versus error of incoming beam phase. Left hand side is for the thermionic gun based DBL and right hand side is for RF gun based option.

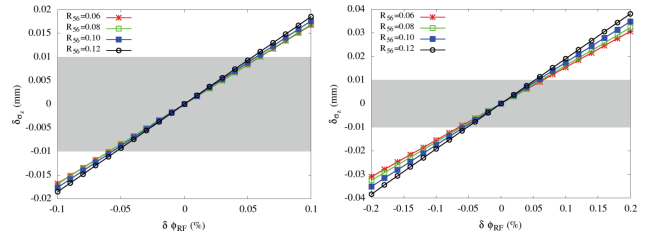

Figure 12: Variation on bunch length versus error of RF phase. Left hand side is for the thermionic gun based DBL and right hand side is for RF gun based option.

seen in Fig. 9 the longitudinal phase space of the bunch from RF gun based linac layout is better than the one from thermionic gun based for de-compressing (or compressing) on drive beam . We have compared both proposal on different bunch compressors taking into account second order effects. Preliminary results shows that the linac based on RF gun has larger tolerances than the thermionic one. However there exists challenges for both type of injectors. The thermionic gun based injector has satellite bunches between main bunches which can be accelerated by DBL up to 2.4 GeV. These bunches also leads instability on beam loading. Second problem of thermionic gun based injector is the bunch to bunch charge instability. This instability can lead instability on beam loading which can cause bunch to bunch energy variation thus jitter on both bunch phase and length. One of the major challenge for RF gun based system is the life time of cathode and the laser power instability for required bunch stabilization.

REFERENCES

- [1] M. Aicheler, et.al. , "A Multi-TeV linear collider based on CLIC technology: CLIC conceptual design report", CERN, Geneva (2012)
- [2] D. Schulte, et. al., "Status of the Clic phase and amplitude stabilisation concept", CERN , Geneva, CERN-ATS-2010-226 , (2010)
- [3] Shahin Sanaye Hajari, CERN, Geneva, Switzerland, private communication.
- [4] A. Aksoy, et al., "Beam dynamics simulation for the Compact Linear Collider drive-beam accelerator", Phys. Rev. ST Accel. Beams, v:14, i:8, p:84402, (2011)
- [5] C.Limborg, et al., "RF Design of the LCLS Gun", LCLS-TN-05-3, 2006