



CERN-ACC-2014-0349

Marco.Pezzetti@cern.ch

A Fuzzy-Oriented Solution for Automatic Distribution of Limited Resources According to Priority Lists

M. Pezzetti, V. Inglese, A. Tovar-Gonzalez
CERN, Geneva, Switzerland

H. Coppier
ESIEE, Amiens, France

M. Almeida
UFMG, Belo Horizonte, Brazil

Keywords: Cryogenics, Automatic Distribution

Abstract

This project provides a solution for problems in which there is a limited cryogen resource that supplies several clients in parallel, which can cause the resource's depletion. This study emerged from the need to solve a specific problem of the Cryogenics Group of the European Organization for Nuclear Research (CERN). A generic solution is proposed for the application in a larger number of situations. The solution is based on the Fuzzy algorithm model, which bases itself on the human reasoning as a problem-solving technique. The Fuzzy approach is presented as well as the limited resource distribution problem, via a cryogenic simulation tools. The paper describes also the comparison of the fuzzy solutions with a former one that has been previously adopted by CERN's Cryogenic Group.

Presented at ICALEPCS 2013, 6-11 October 2013, San Francisco, California

Geneva, Switzerland
November, 2014

CERN-ACC-2014-0349
17/12/2014



A FUZZY-ORIENTED SOLUTION FOR AUTOMATIC DISTRIBUTION OF LIMITED RESOURCES ACCORDING TO PRIORITY LISTS

M. Pezzetti, V. Inglese, A. Tovar-Gonzalez CERN, Geneva, Switzerland
 H. Coppier, ESIEE, Amiens, France
 M. Almeida, UFMG, Belo Horizonte, Brazil

ABSTRACT

This project provides a solution for problems in which there is a limited cryogen resource that supplies several clients in parallel, which can cause the resource's depletion. This study emerged from the need to solve a specific problem of the Cryogenics Group of the European Organization for Nuclear Research (CERN). A generic solution is proposed for the application in a larger number of situations. The solution is based on the Fuzzy algorithm model, which bases itself on the human reasoning as a problem-solving technique. The Fuzzy approach is presented as well as the limited resource distribution problem, via a cryogenic simulation tools. The paper describes also the comparison of the fuzzy solutions with a former one that has been previously adopted by CERN's Cryogenic Group.

INTRODUCTION

This study emerged from the need to solve a specific problem for the distribution of a limited cryogen resource at CERN Cryogenics Group. However, as the project progressed, the problem has proven to be more recurrent than previously thought and a generic solution has been developed in order to solve a larger number of applications. Nowadays the most common way of controlling industrial facilities is by using the classic control theory (PIDs).

However, this approach is usually advantageous when the system dynamic is well known. When it is not, literature brings several other approaches, and Fuzzy Logic is one of them. Fuzzy-based methods are useful when precise mathematical formulations are not feasible, being well-adapted to control systems with unknown dynamics. Therefore, a Fuzzy system [1] fits well as a generic solution, since it doesn't depend on the system dynamic.

PROBLEM DESCRIPTIONS

This project aims to provide a solution for problems in which there is a limited resource that supplies 'n' clients in parallel. The clients system should have different priorities so that their supplies are calculated from the resource availability and the own clients priorities. Moreover, the resource has to decrease dynamically its level as clients are consuming it but it should also be able to be refilled from an external source.

The proposed solution should be such that in cases where there is an abundant quantity of resource, all the

clients are supplied equally. However, as the resource decreases its amount, the supply to the low-priority clients should be limited in order to ensure that there will be enough resource to the high-priority ones, also avoiding deadlocks. Figure 1 illustrates these different scenarios.

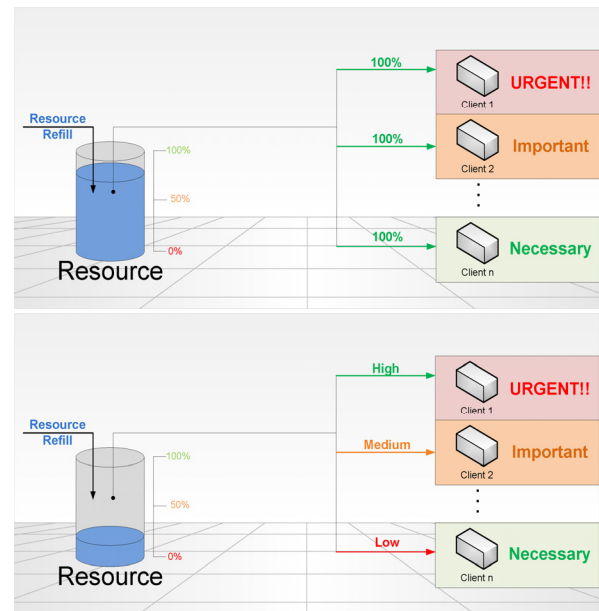

Figure 1: Parallel distribution of resources according to priorities.

Test Bench Priority Handling

The "Test Benches Priority Handling" (TBPH) is a control approach developed at CERN in 2004 [2], offering a solution for the parallel distribution of liquid helium into prioritized test benches. Although the TBPH does not use Fuzzy Logic, it provides a control structure that will be used on the Fuzzy solution. The TBPH was implemented at the CERN-SM18 test facility area. The cryogenic system cools down the LHC superconducting magnets from ambient temperature until 1.9 K. One stage of this process counts with supplying liquid helium at 4.5 K to the cooling clients.

The 4.5 K helium is produced by a He liquefier, stocked in a dewar of 25000 L and is used to supply 12 different clients when they demand for it.

One of the problems of the TBPH was to avoid lowering down too much the helium pressure between the dewar and the client line. If the pressure went down lower than a limit value, the system limited the helium supply to

the low-priority clients so that the pressure could recover itself and go back to normal.

The solution of the TBPH takes as inputs:

The available quantity of the resource “pressure” as a variable and the resource derivative “dPressure/dt” (when negative, how much the clients are demanding from the resource; when positive, how fast the resource recovers itself),

A “priority list” giving the priority for each of the clients is automatically calculated from the situation of the clients and from a priority list given by the operators. In order to obtain the percentage of supply for each of the clients, the TBPH uses two different functions that from now on will be referred to as “Availability Function” and “Distribution Function”:

- [Availability Function] it calculates the ‘Availability’ (from 0% to 100%) of the resource taking as inputs its quantity (*Pressure*) and its derivative ($\frac{dPressure}{dt}$);
- The [Distribution Function] calculates the ‘supply’ (from 0% to 100%) for each of the clients taking as inputs the resource ‘Availability’ and the ‘priority list’.

TBPH Availability Functions

The TBPH uses PID’s to calculate the resource availability. The resource is supplied to all clients when the “pressure” and the “pressure derivative” are far from their set points (the chosen set points are the values for low pressure and low pressure derivative).

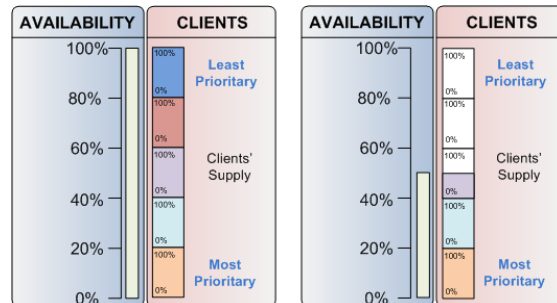
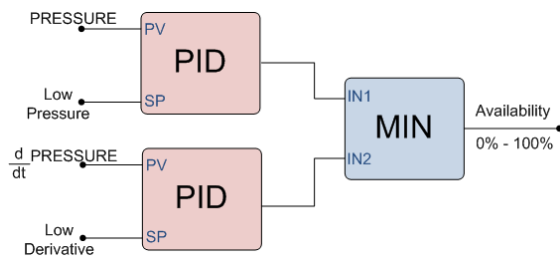

Figure 2: “Availability Function” and “Distribution Function” of TBPH.

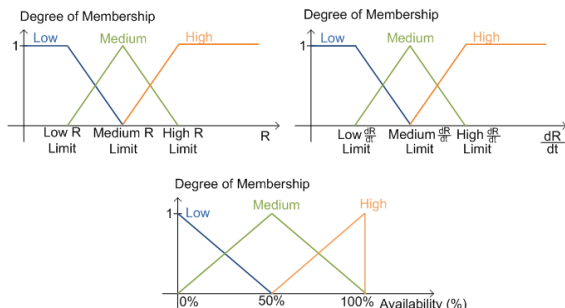

Figure 3: Resource distribution architecture.

The output ‘Availability’ is the minimum of both PID’s, what means that if any of the input variables approaches its own Set Point, the ‘Availability’ will be calculated as lower than 100%.

TBPH Distribution Functions

Whenever the availability is lower than 100%, the TBPH limits the supply of the client with the lowest priority. If the availability continues to go down, the second least priority client’s supply will be limited and so on. Figure 2 illustrates the Distribution Function for a system with five demanding clients when the availability is 100% and when it is 50%. When ‘Availability’ is calculated as 100%, all the clients are supplied equally with the maximum of supply. When ‘Availability’ is calculated as 50%, the two clients with highest priority receive maximum, the third receives 50%, and the two with lower priority are not supplied.

TBPH Analysis

Before the introduction of the TBPH, the helium distribution was handled manually at the SM18 CERN test facility. The implementation of the TBPH improved the helium distribution performance, ensuring that the cryogenic installation was constantly working at its maximum capacity.

Therefore, the TBPH can be thought as a possible solution for distribution of limited resources. However, its design relies on tuning of PIDs, which implies the need of a previous study of the system behavior in order to avoid the introduction of undesired dynamics in the process regulation.

FUZZY PRIORITY SYSTEM - FPS

The FPS uses the same general architecture of the TBPH using an “Availability Function”. What changes is the way of calculating the “Availability Function” and the “Distribution Function”: on FPS they are calculated via Fuzzy inference.

FPS Availability Function

The Fuzzy model of the “Availability Function” is shown on Figure 3 (the resource is represented as ‘R’ and its derivative as $\frac{dR}{dt}$).

As this solution features three sets of membership for each input, the ‘Base of knowledge’ is composed of nine rules to infer the output ‘Availability’. This base of rules should be filled according to the knowledge of an expert of the system.

FPS Distribution Function

The Fuzzy model of the “Distribution Function” is shown on Figure 4. The input ‘priority’ of each client should be given from ‘1’ (for the one with highest priority) until ‘n’ (for the one with lowest priority). After that, this system should normalize these values in function of the number of clients demanding for the resource using the equation:

$$\text{Normalized Priority} = \frac{\text{Priority}-1}{n-1}$$

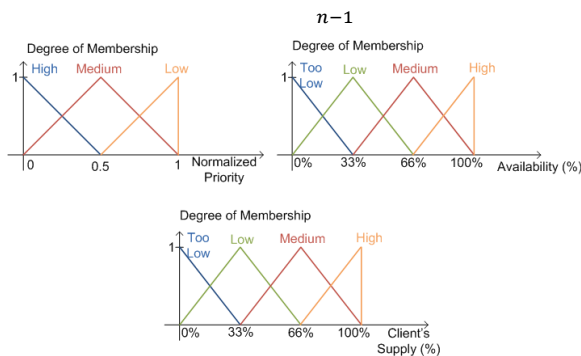

Figure 4: Fuzzy sets of the ‘Distribution Function’. The normalized priority rescales the priority (from ‘1’ to ‘n’) into values between ‘0’ (highest priority) and ‘1’ (lowest priority).

FPS General Architecture

The control architecture for the FPS is shown on Figure 5. There is one Fuzzy that calculates the resource ‘Availability’ and ‘n’ copies of the “Fuzzy Distribution Function” to calculate the supply for each of the ‘n’ clients.

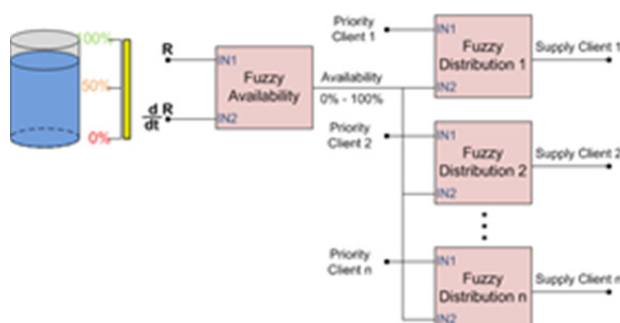

Figure 5: Control architecture of the FPS.

CASE STUDIES

In order to test the proposed solution, it has been made simulation tests using the software EcosimPro® 4.8 and its cryogenic library designed at CERN [3] [4].

Limited Pressure as Resource

In order to compare the TBPH with FPS, it has been developed a simulation diagram that simulates the cryogenics process on which the TBPH works. The simulation assumed that the ‘6 kW Coldbox Linde’ produces 20 grams of helium per second and that there are four clients demanding for helium to cool down themselves. Each client starts on a temperature of 90 kelvin and they cool until the temperature of 4.5 Kelvin. A specification of this system is that the pressure at the distribution line should not go below 1350 mbar.

A first simulation has been made without the use of any priority distribution control. The four clients were cooled down simultaneously, as shown on Figure 6 (the temperature of the four are superposed). We see that the pressure went below 1350 mbar.

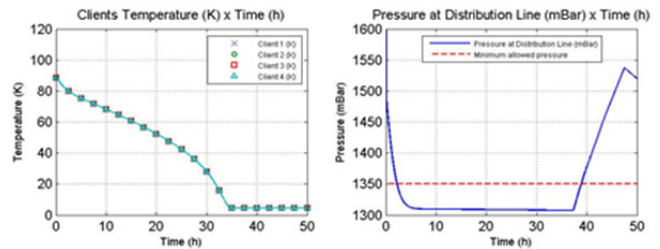

Figure 6: Cool down simulation without pressure distribution control.

A simulation with similar conditions as the previous one, excepting that the TBPH has been applied is shown in Figure 7. The client with highest priority is the Client 1, followed in order by Client 2, Client 3 and then Client 4. The used set points for the pressure PID and its derivative have been, respectively, 1380 mbar and 15 mbar/min. We can see that the clients with lower priorities are limited in supply in order to guarantee pressure regulation.

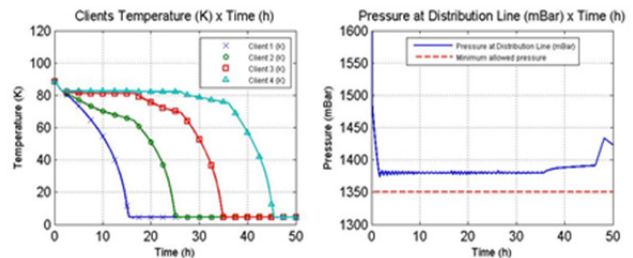

Figure 7: Cool down simulation using TBPH.

Another simulation in similar conditions, but now using the FPS model is shown in Figure 8. When the pressure is over 1400 mbar there is no supply restriction. As soon as the pressure transcends the value of 1400 mbar, there will be limitation to the low priority clients. One difference of the FPS to the TBPH is that instead of using a fix set point, this method uses a working zone (in this case,

between 1350 mbar – Fuzzy Low R Limit – and 1400 mbar – Fuzzy High R Limit).

Despite regulating the pressure in a fix set point, the TBPH brought an oscillatory dynamic to the system, due to its chosen P, I and D parameters.

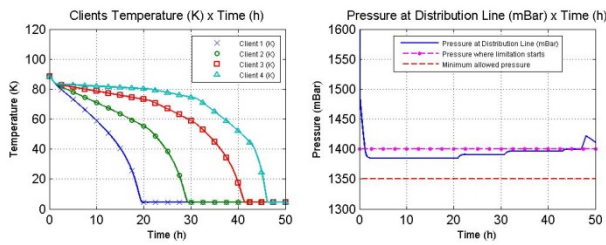

Figure 8: Cool down simulation using FPS.

Obviously, the P, I and D parameters can be better tuned on TBPH if a dynamic study is made for the process, what is not always possible. On the other hand, the FPS is easily tuned using nothing but process knowledge and specifications.

Limited Helium as Resource

Nowadays there is no priority distribution control that takes into account the Dewar’s level on the CERN-SM18 facility, even though this is an aspect on which improvements would increase the performance of the system.

A cool down simulation of 4 clients at the same time, with the Dewar’s level starting at 55% and no priority distribution control prove that the Dewar level go forward zero level is shown in Figure 9.

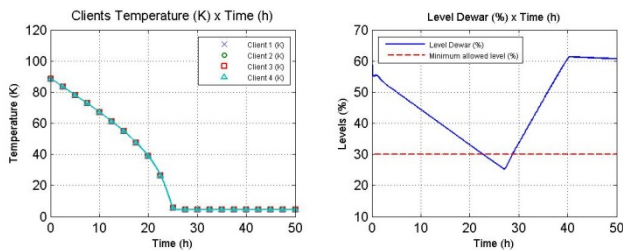

Figure 9: Cool down simulation without level distribution control.

A cool down simulation using the same boundary condition, but using the FPS, prove the effective limitation to the low priority clients (figure 10). The limitation is maximal when level reach 30%, guaranteeing that the level never goes below its minimal allowed value and allowing the client to the be served in respect to the given priority.

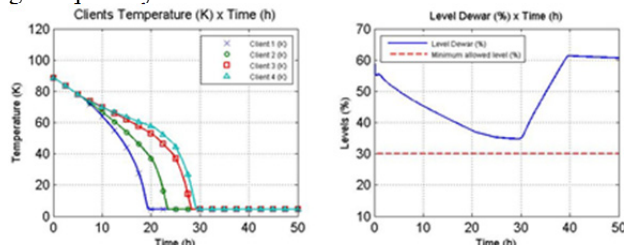

Figure 10: Cool down simulation using FPS for level control.

CONCLUSION

Fuzzy Logic brings a new way of approaching control problems. This method focuses mostly on what the system should do rather than trying to understand how it works. The ‘priority distribution’ problem can easily be solved using Fuzzy instead of establishing a mathematical model of the system for PID project. The results obtained in simulation for the Fuzzy Controller indicate how it fits as a solution for the automatic distribution of limited resources according to priority lists. Further works will consist of implementing the designed solution for the CERN-SM18 facility. Moreover, one future association of the Fuzzy Logic with Neural Networks or Genetic Algorithms may introduce some improvements on the system’s performance by allowing an adaptive adjustment of its parameters and thus having better capacity to follow changes on the process behaviour.

REFERENCES

- [1] S. Luber, "Cognitive Science Artificial Intelligence: Simulating the Human Mind to Achieve Goals," 3rd International Conference on Computer Research and Development (ICCRD), vol. 1, pp. 207-210, 2011.
- [2] A. Tovar, J. Axensalva, L. Herblin, J. P. Lamboy and B. Vullierme, "Automatic Management Systems for the Operation of the Cryogenic Test Facilities for LHC Series Superconducting Magnets," in Transactions of the Cryogenic Engineering Conference - CEC, Keystone, United States of America, 2005.
- [3] B. Bradu, "Modélisation, Simulation et Contrôle des Installations Cryogéniques du CERN," Doctoral Dissertation, École Doctorale des Sciences et Technologies de l’Information des Télécommunications et des Systèmes, Paris - France, 2010.
- [4] M. Pezzetti, B. Bradu, P. Gayet and J. Vasseur, "Helium Cryoplant Offline Commissioning and Operator Training: Two applications of the PROCOS Simulation System at CERN," in International Conference on Accelerator & Large Experimental Physics Control Systems, Kobe - Japan, 2009.