

Long-term study of optimal gas purifiers for the RPC systems at LHC

*E.Altuntas, M.Capeans, I.Glushkov, R.Guida, F.Hahn, S.Haider,
B.Mandelli, S.Rouwette*

PH-DT, CERN

Abstract

This study investigates the impurities produced in the gas of heavily irradiated RPC chambers and the properties of possible purifiers for the closed-loop gas systems used in the LHC experiments. The goal is finding the operational conditions that will keep the RPC gas purity near the level of the fresh gas quality to ensure proper operation of the large RPC systems at high luminosity.

The properties and performance of a large number of purifiers have been understood. On that basis, an optimal combination of different filters consisting of MS (MS) 5Å and 4Å, and a CuO catalyst R11 has been chosen and validated irradiating a set of RPCs at the CERN Gamma Irradiation Facility (GIF) for several years. An important feature of this new filters configuration is the increase of the cycle duration for each purifier, which results in better stability and reduced downtime of the gas systems. If needed, it permits to comfortably increase the gas flow in the detectors during the high luminosity running at LHC.



Table of Contents

1. Introduction	3
2. Experimental set-up	3
2.1. Gamma irradiation facility	4
2.2. Gas system and gas analysis	5
3. Characterization of purifiers	8
3.1. Filtering capacity of common gas purifiers	8
3.2. Fluoride production and filtering	9
3.3. Purifiers regeneration	10
3.4. Purifiers conditioning	11
3.5. Original purifiers configuration in the LHC RPC systems	12
4. Long-term validation of highly irradiated RPCs in an optimized closed-loop gas system	13
4.1. Optimization of the filters	14
4.2. RPC gas quality using optimized filter configurations	15
Gas humidity	15
RPC-related impurities	17
Fresh gas injection	17
4.3. Long-term performance of the RPCs irradiated at the GIF	19
Bakelite bulk resistivity	19
Gas gain uniformity	20
5. Implementation of the optimized filter's configuration at LHC	22
6. Conclusions	24
7. Bibliography	26

1. Introduction

Resistive Plate Chambers (RPCs) are widely employed for the muon trigger systems at the Large Hadron Collider (LHC) thanks to their fast time resolution (~ 1 ns), suitable space resolution (~ 1 cm) and low production cost (~ 100 €/m²). Most RPC systems at LHC are operated in a non-flammable gas mixture of C₂H₂F₄-iC₄H₁₀-SF₆-H₂O, which is relative expensive (~ 60 €/m³). Based on economical grounds and due to the large system size (~ 4000 m²), RPCs are operated in re-circulating gas systems (90-95% closed-loop circulation).

Several studies indicate a clear correlation between RPC performance and the quality of the gas mixture [1]. The current drawn by the chambers can rapidly rise if the amount of pollutants in the mixture increases, be due to poor gas quality at the source (e.g. polluted Freon bottles), the accumulation of impurities due to malfunctioning or saturated gas purifiers, leaks in the gas system or detectors, etc. In the high radiation environment expected at LHC many different, chemically reactive impurities are created in the RPC gas, mainly hydrocarbons, HF, F⁻ and Freon-type molecules. They are potentially dangerous for the detector materials, the gas system and ultimately will degrade the detector performance. Therefore the current LHC gas systems have been designed to operate in closed-loop with a small fraction of fresh gas continuously added (typically 5%), and containing a set of gas purifiers that keep the water and oxygen levels below 1000 ppm, and can also filter minor quantities of other impurities [2]. At higher luminosities the impurity concentration will increase and furthermore, chemical reactions between the purifiers and the impurities can degrade the absorber materials themselves or release new pollutants into the gas flow.

This study investigates the impurities produced in heavily irradiated RPC chambers and the properties of possible absorbers to be used at LHC in order to keep the gas purity near the level of the fresh gas quality. Several RPCs are operated at the CERN Gamma Irradiation Facility (GIF) in a high radiation environment that permits to accelerate by several factors the irradiation levels expected at LHC. In this way, the production of typical impurities can be enhanced, and at the same time long-term accelerated tests of the RPC performances can be carried out. The polluted return gas from irradiated RPCs is sent to several purifier cartridges, each containing a different filtering material. The effectiveness of each material is studied using gas chromatography and mass-spectrometry techniques. Results of these tests have revealed an optimized configuration of filters that will be implemented in the ATLAS and CMS RPC muon systems for higher luminosity operation.

2. Experimental set-up

The experimental setup consists of several (up to 12) double gap Bakelite RPCs that are irradiated at the CERN GIF; this set-up has been extensively used to test and validate gas detector systems for LHC. Each detector has a surface of 120×205 cm² and a 2 mm wide gas gap. In the double gap layout used for this test, two gaps are connected in series (i.e. the output of the first gap is the input of the second one, and the read-out strips are in between the two gaps) (Fig. 1). All gaps were part of the standard chamber production for the LHC experiments. The Bakelite panel bulk resistivity at production was about $5 \cdot 10^{10}$ Ωcm. Chambers are connected to a versatile closed-loop gas system with several gas analyzers. Purifiers can be studied in detail, at the same time that chambers performance is regularly monitored.

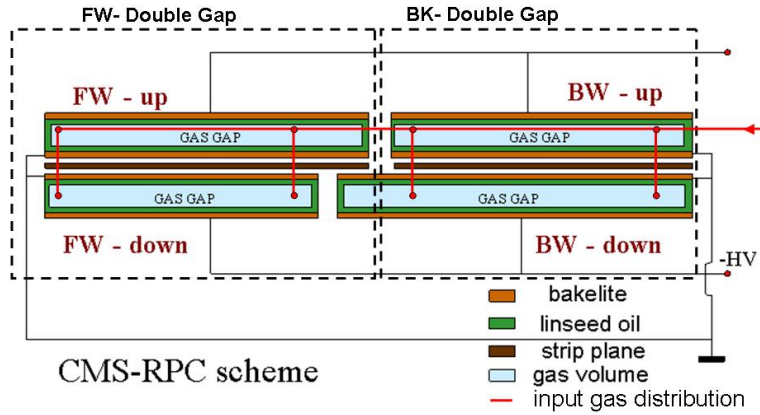

Fig. 1 Schematic view of an RPC detector used during the test: gas volume, double gap position and layout of the gas distribution circuit are indicated.

2.1. Gamma irradiation facility

The intense gamma source at the GIF simulates appropriately the RPC's radiation background during LHC operation [3]. The ^{137}Cs source has an activity of about 590 GBq. A set of moveable lead filters located in front of the source allows tuning the radiation intensity. In the current tests, the RPCs were located at about 2 m from the ^{137}Cs source, resulting in an average counting rate of 200 Hz/cm² over almost the whole detectors' surface, and a dose rate of 1cGy/h; in these conditions the overall acceleration factor with respect to the normal operation conditions at nominal luminosity, for instance for the RPCs in the barrel region of the CMS detector, is about 30. The RPCs are placed inside a tent where temperature and relative humidity are regulated to about 20 °C and 40%, respectively. (Fig. 2).

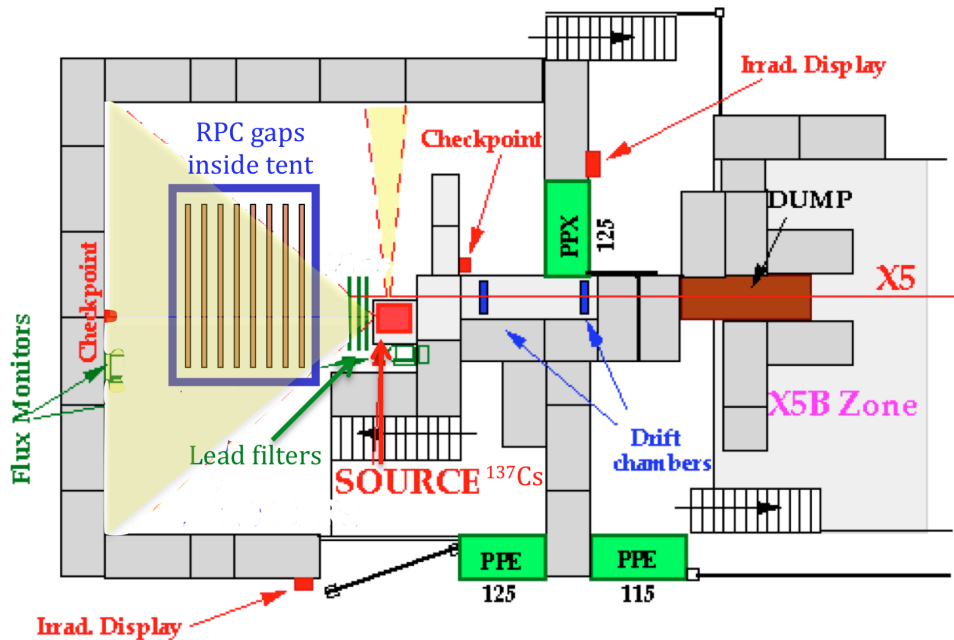

Fig. 2 Floor plan of the GIF showing the large size RPCs under test placed at 2 m of the ^{137}Cs source. The gas system and analysis devices are located outside the bunker and are thus not shown in the picture.

2.2. Gas system and gas analysis

The gas system used during the tests, shown schematically in Fig. 3, is a small replica of the gas systems operating in the LHC experiments. It breaks up in functional modules: a gas mixer and humidifier units, followed by a distribution unit, pump module that pushes the gas around, followed by a set of gas purifiers. A minor amount of fresh gas (typically below 10%) is continuously added to the loop.

The system at the GIF, in addition, allows the simultaneous operation of two sets of RPCs in different gas conditions: one set of RPCs is operated in open-mode (i.e. the gas is exhausted to atmosphere) and it serves to monitor chamber performances connected to it in ideal conditions; the second set of chambers is hooked to the closed-loop gas circuit, to test the chamber performance for a given gas quality condition.

A dedicated filters rack can host up to six different filtering cartridges. The return gas mixture from the irradiated RPCs is divided into the six channels by means of flow regulators also used to measure the gas volume flowing through each cleaning agent. Several connections before and after each cartridge allow both sampling the gas mixture and setting up the sequence of different filters.

A network of several sensors (temperature, relative humidity and pressure) monitors environmental conditions and gas mixture concentrations.

It should be noted that the purifier modules currently being used in the LHC gas systems consist of two sets of cleaning cartridges installed in parallel. One set is in operation while the second one is automatically regenerated at the same time. The cartridges can be filled with several different absorbers depending on the requirements of each system. A typical purifier module is shown in Fig. 4 and described in detail elsewhere [2].

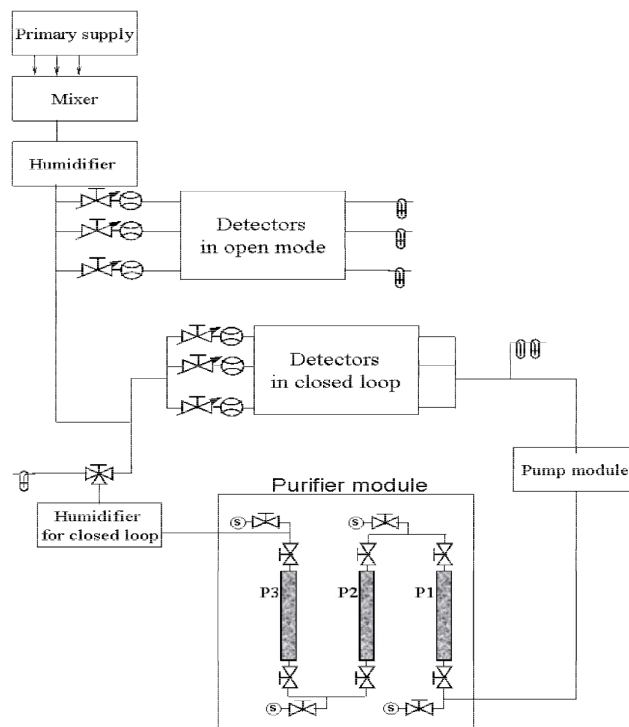

Fig. 3 Schematic view of the gas system used during the test. Two sets of gas lines are available for detector operation in open mode and in closed-loop circulation. After the detectors, in the open mode circuit, the gas is sent to a filter rack containing independent cartridges allowing a parallel, detailed study of cleaning agents. The closed-loop circuit is equipped with a purifier module that can host up to three cartridges.

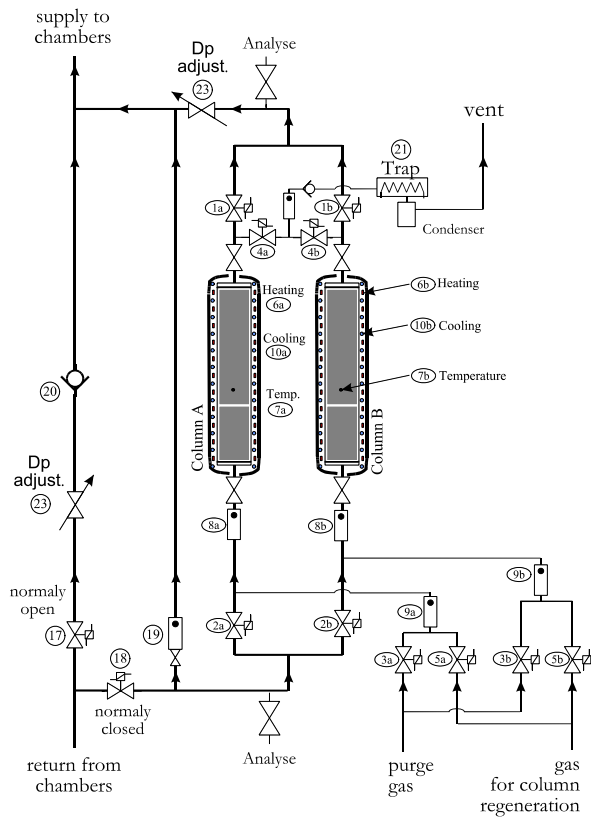

Fig. 4 Typical purifier component layout in the LHC systems.

Gas quality is a fundamental parameter in this study. Thus, a number of gas analyzers has been selected and is continuously used to characterize in detail the gas quality at different sampling points. Table 1 summarizes the characteristics of the available analysis devices, all of them reaching the ppm detection sensitivity.

Fluoride ions, largely produced inside the gas volume during RPC operation, are very reactive impurities. Several studies [4] have proven that the fluoride ions present in the gas mixture are harmful to RPCs. In particular, the analysis of the Bakelite electrode surface after the long-term irradiation of RPCs has shown the formation of local white spots (Fig. 5a). The chemical composition has been studied using an electron microscope equipped with an EDS X-ray spectrometer detector (SEM EDS/X-ray). A comparison of the X-ray spectra between the reference surface (Fig. 5b) and the surface in the defected areas (Fig. 5c) reveals a high fluoride concentration, the presence of Na and absence of N. From these observations it is possible to conclude that both the linseed oil and the melamine layers have been etched. As a confirmation, chamber performances were also starting to show some deterioration effect (mainly an increase of the dark current). Thus, fluoride ions are impurities that should be kept under control.

Analysis device	Detection properties
Double channel ISE station	Fluoride ion concentration
Agilent MicroGC 3000 + Mass Spectrometer MSD 5975	Concentration, identification of gas components
Electrochemical cell (Teledyne)	O ₂ concentration
Chilled mirror (Dew Master)	H ₂ O concentration

Table 1 Gas analysis devices used in the GIF gas system.

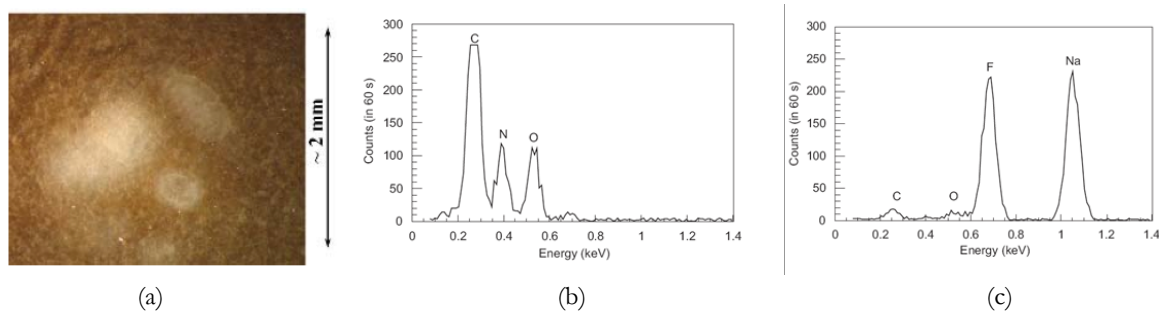

Fig. 5 a) Picture of a typical surface defect in the Bakelite electrodes. b) SEM-EDS spectrum of the reference Bakelite surface. c) SEM-EDS Spectrum of the defected area. In the area is clearly visible the presence of fluorine. The presence of Na indicates that the superficial layers (linseed oil and melamine) are etched.

During the present test the use of a double channel ISE station allows the simultaneous measurement of fluoride ions concentration in different detectors or different gas sampling points. The measurement of the F^- production rate is performed recording the increase of concentration in a well-defined volume of water sample contained in a bubbler connected to a given gas sampling point. Fig. 6 shows a typical result for two different detectors. For each RPC, the change of slope between the operation at 9.4 kV and 9.6 kV is clearly noticeable, as well as the very low accumulation even with the detectors turned off, probably due to the gas replacement in the gap and the cleaning effect produced by the gas flow.

In addition to the important amount of fluoride ions measured at the exhaust of irradiated RPCs, many other molecules are produced as a result of the breaking of the main gas mixture components by means of ionization, UV photons, charge multiplication and the subsequent recombination/re-arrangement of fragments. In order to identify unknown pollutants, an Agilent 3000 microGas Chromatograph (microGC) coupled to an Agilent 5975 mass spectrometer detector (MSD) is used to detect, quantify and identify pollutants. The microGC is in fact a set of 3 independent microGC modules with own micro injector, analytical column and Thermal Conductivity Detector. The first module uses an OV1 polar column mainly indicated for separation of relatively heavy hydrocarbons (from C_4 to C_{12}). The second module contains a PoraPlotU (PPU) column suitable for separation of hydrocarbons in the range C_1 to C_4 , CO_2 , CH_4 , H_2O , H_2S , SO_2 , N_2O . The last module uses a MS 5\AA column. It separates light components and noble gases (i.e. Ne, H_2 , O_2 , Ar, N_2 , CH_4 , CO). The microGC outputs, relative to the OV1 and PPU column, can be selected and coupled to the mass spectrometer, making possible the identification of each separated compound. Most compounds are detected by the analysis station in a concentration scale below 10 ppm with a very good linearity of the answer.

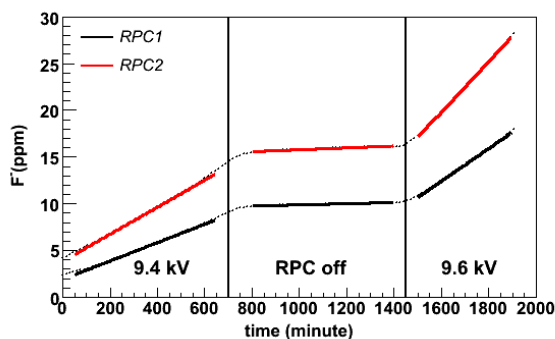

Fig. 6 Concentration of F^- ions in two RPCs as a function of time. The change in the accumulation rate between the period in which detectors are operated at 9.4 kV and 9.6 kV is clearly visible. A very low accumulation is also measured when the RPCs are off; this can be attributed to both a gas replacement inside the gas volume and a cleaning effect of the internal electrode surface produced by the gas flow.

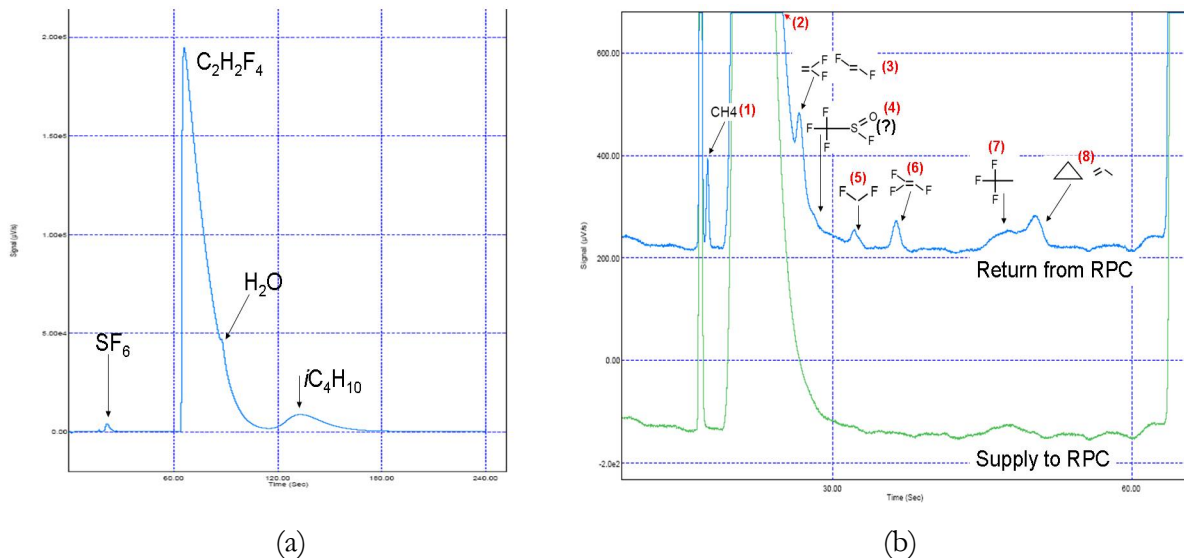

Fig. 7 (a) Gas chromatogram of the gas mixture as it enters the RPCs. The chromatogram has been obtained using a PoraPlotU column. The main components of the RPC gas mixture are visible. (b) Zoomed area of the chromatograms of the clean gas supply and the returned mixture of irradiated RPC detectors, where pollutants show up.

Fig. 7 (a) shows a typical chromatogram of the gas mixture at the exhaust of heavily irradiated RPCs (counting rate of 200 Hz/cm²). The microGC can separate the main gas mixture components: C₂H₂F₄, iC₄H₁₀, SF₆ and H₂O. Fig. 7 (b) shows a zoom of chromatograms from the clean gas supply and the gas returning from the irradiated chambers. In the latter, a multitude of minor peaks have been identified with the MSD and reveal that pollutants are mainly Freon-type and hydrocarbons molecules, with typical concentrations of the order of hundreds of ppm.

3. Characterization of purifiers

3.1. Filtering capacity of common gas purifiers

The basic motivation of closed-loop gas circulation is to combine a sensible gas replacement inside the detector with an acceptable consumption of fresh gas, in order to reach bearable operational costs. In many cases the highest tolerable recycling rate can be significantly increased if basic impurities are filtered out from the gas. In order to fill and size the purifier cylinders adequately some assumptions on the type and amount of impurities in the detectors must be made. Estimates for oxygen and water concentrations can be reasonably made, as these pollutants appear generally due to air leaks and air diffusion and can be easily measured experimentally. Thus, the selection of purifiers is typically based on just those parameters. This practice is obviously not applicable for the gas impurities generated in irradiated RPCs.

Table 2 shows the most common absorber materials used in gas detectors' systems, with relevant data related to nominal adsorption capacity for water and oxygen. Two main types are classically used: molecular sieves¹ and metallic catalysts^{2,3}. The former is a material containing tiny pores of a precise and uniform size that is used as an adsorbent for gases and liquids. Molecules small enough to pass through the pores are adsorbed while larger molecules are not.

¹ Molecular Sieves (MS) adsorbents (3A, 4A, 5A...) by Zeochem[®]. Product information can be found at - http://www.zeochem.ch/en/products/molecular_sieves/index.htm

² BASF Copper-oxide catalysts (R11, R11-3, R11-G...) for oxygen removal; developed and fabricated by BASF-The Chemical Company. Specific product information can be found at - http://www.adsorbents.pro/application/oxygen_removal.aspx

³ Leuna catalysts supplied by Katalleuna GmbH, more information at - http://www.infralleuna.de/cms_e/index.php?id=4,36,0,0,1,0

	Molecular Sieve 5A	Molecular Sieve 4A	Molecular Sieve 3A	BASF Catalyst R3-11/R3-11G	BASF Catalyst R3-12	Leuna Catalyst 6525/6525T
Short name	MS 5A	MS 4A	MS 3A	Cu R11	CuZn R12	Ni Al ₂ O ₃
Producer	Zeochem	Zeochem	Zeochem	BASF	BASF	Leuna
Composition	Zeolite (Ca) 0.7 CaO . 0.3 Na ₂ O . Al ₂ O ₃ . 2 SiO ₂ . n H ₂ O	Zeolite (Na ⁺) Na ₂ O . Al ₂ O ₃ . 2 SiO ₂ . n H ₂ O	Zeolite (K ⁺) 0,45 K ₂ O . 0,55 Na ₂ O . Al ₂ O ₃ . 2 SiO ₂ . n H ₂ O	Activated copper oxide deposit on porous graphite support	CuO-ZnO	Ni-NiO, Al ₂ O ₃ carrier
Adsorption capabilities	Adsorbs hydrocarbons to n- C ₄ H ₁₀ , alcohols to C ₄ H ₉ OH, mercaptans to C ₄ H ₉ SH. Will not adsorb isocompounds or rings greater than C ₄	Adsorbs H ₂ O, CO ₂ , SO ₂ , H ₂ S, C ₂ H ₄ , C ₂ H ₆ , C ₃ H ₆ , and ethanol. Will not adsorb C ₃ H ₈ and higher hydrocarbons.	Adsorbs NH ₃ , H ₂ O	O ₂ , CO, H ₂ and others from industrial gases and liquids	Removal of traces of arsine, phosphine, COS, H ₂ , and other reactive compounds from hydrocarbons in vapor or liquid phase.	O ₂ from N, Ar, Ne and CO ₂
Nominal H₂O/O₂ absorption capacity	H ₂ O: 200 g/kg	H ₂ O: 200 g/kg	H ₂ O: 200 g/kg	O ₂ : 4 l/kg, 10l/kg is saturated with water H ₂ O: 45–97g at 1.6 bar abs.		O ₂ : 15 l/kg
Regeneration needed	Yes	Yes	Yes	Yes	No	No
Currently used by:	CMS and ATLAS RPC	LHC-b RICH1 LHC-b RICH2	CMS and ATLAS RPC ATLAS TGC CMS DT LHC-b MUON	CMS and ATLAS RPC ALICE TRD CMS DT LHC-b MUON	CMS and ATLAS RPC	CMS and ATLAS RPC CMS CSC

Table 2 Absorber materials typically used in closed-loop gas systems. Data on absorption capacity has been taken from [5-6].

The purification process in metallic catalysts is based on the catalytic oxidation of reducing species. For instance, in the mixed-metal catalyst CuO BASF R3-11 (hereafter short named Cu R11, as indicated in Table 2), the copper is oxidized by oxygen molecules present in the gas stream, forming a copper oxide and thus removing oxygen from the gas flow.

3.2. Fluoride production and filtering

In this study, the relevant information relates to finding the filtering capacity of cleaning agents for fluoride ions and other gaseous products detected in the gas exhausted by heavily irradiated RPCs.

The evaluation of fluoride concentration in the gas has been made using a fluoride specific electrode and liquid chromatography. Several mixtures with slightly different concentrations of iC_4H_{10} and SF_6 have been tested in order to find that one that would reduce the fluoride production [1]. However, it has been found that the production rate of fluoride ions does not change dramatically with varying iC_4H_{10} and SF_6 concentrations by few percentages around the normally used values. This result is summarized in Fig. 8 as a function of RPC efficiency. There is no significant difference between all tested mixtures, however it seems that a mixture containing 3.5 to 5% iC_4H_{10} and a double-gap configuration (i.e. lower working point in terms of high voltage) gives the best results.

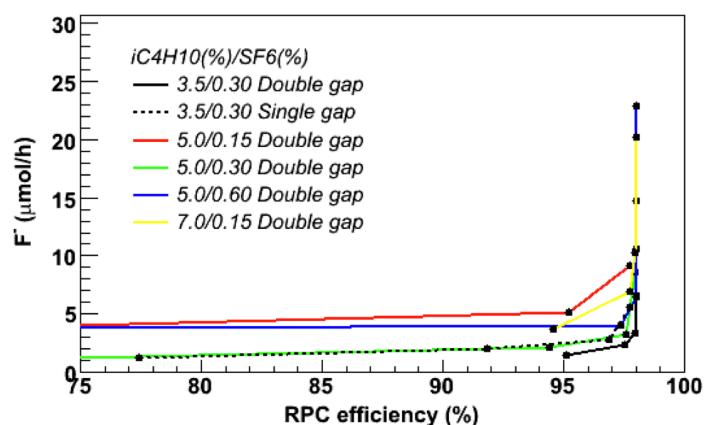

Fig. 8 Fluoride ions concentration measured in the RPC return gas for several mixture compositions as a function of detector efficiency.

Since it does not seem possible to reduce significantly the rate of production of fluoride ions, their absorption in different purifiers has been studied. As shown in Fig. 9, F^- is very effectively filtered by a combination of molecular sieves (MS) consisting of 10% MS 5 Å and 90% MS 3 Å.

3.3. Purifiers regeneration

Purifiers need to be regenerated before they are used the first time, and after they reach saturation. During normal run conditions, water is trapped in the MS adsorbents thanks to relatively low forces (i.e. Van Der Waals forces). Once the MS material is saturated, it can be easily regenerated by a heating cycle at about 200°C and either flushing with an inert gas (i.e. Ar, N₂, etc.) or creating vacuum in the cartridge volume.

For metallic catalysts, the reaction involved in this process is the chemical reduction of metal oxide to metal. In the LHC gas systems, the regeneration includes flushing with a mixture containing H₂ (for instance Noxal, composed of 6% H₂ and Argon) while the cartridges are heated up to 200 °C minimum. The process, from the start till the cartridges reaches room temperature, takes about 24 hours. Then, the cartridge is purged with the fresh gas mixture for some time.

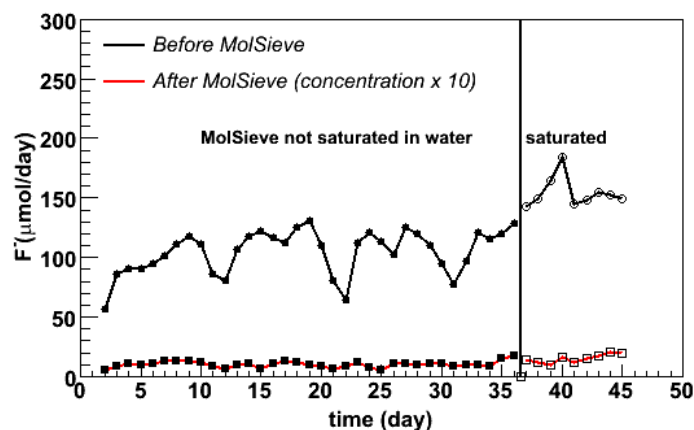

Fig. 9 Fluoride ions concentration measured in the gas mixture before and after the MS filter. For the latter, the F^- is reduced by a factor 100. Similar tests are being performed on all the other cleaning agents.

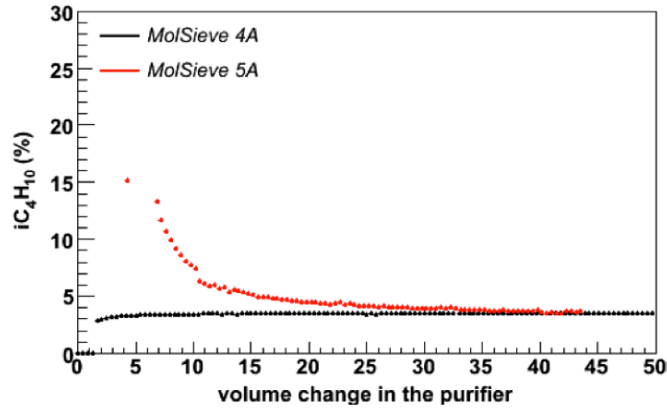

Fig. 10 Concentration of iC_4H_{10} in the RPC gas mixture after passing through a purifier during the conditioning phase. The MS 4Å does not absorb the iC_4H_{10} but it releases Ar for long time. MS 5Å absorbs the $C_2H_2F_4$ at start-up and as a consequence the iC_4H_{10} concentration becomes higher [7].

3.4. Purifiers conditioning

During the first operation of some purifier agents (measured to be up to 10-100 volume changes) the main components of the RPC gas mixture can be trapped producing a temporary alteration of the gas mixture composition. This is very relevant for the operation of closed-loop gas systems, where the purified gas is sent back to the loop. In order to solve the problem a so-called *conditioning phase* has been introduced in which the purifier is flushed with a defined equivalent volume of process gas before it is sent into the closed-loop. Fig. 10 shows as an example the effect observed on the iC_4H_{10} for two of the tested MSs. The MS 5Å strongly absorbs $C_2H_2F_4$ during the first 30 volume changes; therefore, during that period of time the concentration of iC_4H_{10} in the gas mixture becomes higher with respect to the nominal value. On the other hand, the MS 4Å purifier does not absorb any component of the RPC gas mixture (Fig. 10). This MS shows good filtering capacity for the RPC specific gas impurities and its conditioning cycle is reasonably short (i.e. equal to MS 3Å). The analysis of the two purifiers shows that it is better to utilize the MS 4Å because it does not absorb any mixture components. However, during the test, it was noticed that if Argon is used to fill the MS 4Å, the purifier releases Argon for long time after the regeneration, therefore it is regenerated by pumping down.

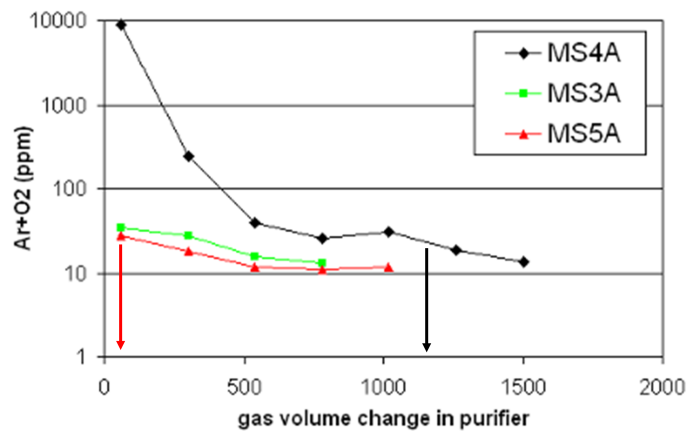

Fig. 11 Argon concentration in the mixture after the MS purifier during the first phase of operation. Argon is used during the regeneration phase. MS4Å releases Argon for at least 1000 equivalent volume change per hour before.

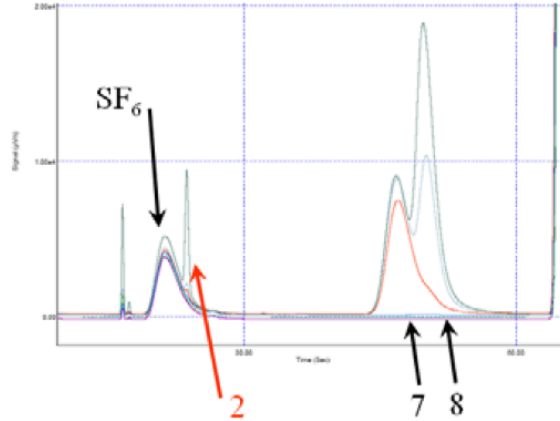

Fig. 12 Chromatogram (obtained with the PPU module) showing a detailed view of the mixture coming out of a cartridge containing Ni-Al₂O₃ catalyst after a one day stop of the flow. Extra components are extremely enhanced most probably due to the fact that the mixture was left reacting in the cartridge for long time. The numbering of the extra-components refers to Fig. 7.

Some purifiers can also react with the RPC mixture and eventually release impurities into the main gas stream. As an example, Fig. 12 shows few extra-signals detected by gas chromatography [1] in the gas passing by the Ni-Al₂O₃ catalyst. Some signals are strongly enhanced after a first phase of operation of the filter. Therefore the conditioning phase of some purifiers needs to account also for this undesirable effect.

3.5. Original purifiers configuration in the LHC RPC systems

Currently the RPC purifier modules in operation in the LHC experiments contain a combination of five different cleaning agents (Fig. 13): MS 5Å (10%) and MS 3Å (90%) hosted in a 24 l cartridge (column P1), and a mixture of catalysts Cu R11 (25%), CuZn R12 (25%) and Ni-Al₂O₃ (50%) all contained in a second 24 l cartridge (column P2).

MS absorbs water and MS 5Å in particular is also very effective filtering the typical pollutants in the RPC irradiated gas, but it also absorbs C₂H₂F₄ that is a key gas component for RPC mixture. Therefore its bulk quantity in the purifiers has to be small because of the otherwise extremely long conditioning time. For this reason, 90% of the needed amount of MS has been replaced by MS 3Å, which is transparent C₂H₂F₄, and effectively adsorbs water, but regrettably is very ineffective filtering radiation-induced impurities.

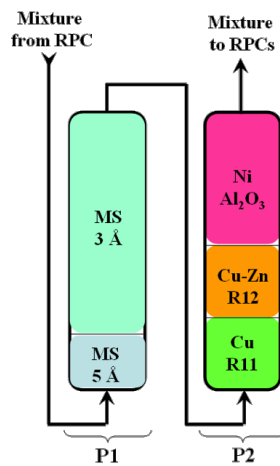

Fig. 13 Original purifier configuration used in the LHC experiments.

	Purifier P1	Purifier P2
Number of regenerations	80	30
Pre-Saturation Vol (m³)	160	850
Process gas flow (m³/h)	5	5
Pre-Saturation time (h)	33	163
Pre-saturation time (day)	1.4	6.8
Regeneration time (min)	480	360
Regeneration temperature (°C)	220	200
Conditioning time (min)	150	720
Conditioning flow (l/h)	100	100
Conditioning time (Vol)	10	50
Material life time (cycle)	120	45

Table 3 Purifiers parameters in the original LHC configuration.

Metallic catalysts, like Cu R11, CuZn R12 and Ni-Al₂O₃, are typically used as O₂ absorbers. However, as it has been explained in the previous section, they can release or enhance the presence of some pollutants in the RPCs' gas stream. Cu R11 is a quite effective filter, while CuZn R12 does not show any absorption capacity and, moreover, it also enhances the amount of C₂H₂F₂. Concerning the Ni-Al₂O₃ catalyst, it absorbs some impurities but also enhances the concentration of others.

Table 3 gives some key operational parameters of the purifiers (MS in cartridge P1 and metallic catalysts in cartridge P2) being used by the RPC systems at LHC.

The limiting factors of the present LHC configuration are therefore as follows:

- Most impurities produced during RPC operation are not filtered.
- The overall capacity to absorb water is low (1300 g of H₂O per cycle).
- The cycle time, i.e. the time in which the filter is effective, is very short: 1.5 days for the MS. This time period is just long enough to complete the full regeneration process; therefore it is almost impossible to increase the gas flow in the system.
- The number of regeneration cycles over one LHC running period is high (about 200) and the materials (especially the metallic catalysts) are not guaranteed to perform properly after so many cycles.

The long-term test (several months) of this configuration of purifiers at the GIF is crucial to, first, understand the detailed operation of the RPC gas systems currently used at LHC, and second, study their possible limitations when RPC system will be operated in a higher radiation environment.

4. Long-term validation of highly irradiated RPCs in an optimized closed-loop gas system

Based on the detailed understanding and systematic characterization of several purifiers [7], three different configurations of purifiers have been tested at the GIF set-up during the years 2009-2011. Fig. 14 shows the average integrated charge by the irradiated RPCs versus time; the total accumulated charge is equivalent to 10.2 years of RPC operation in the CMS Barrel region. The test time is subdivided into four intervals:

1. 'Set-up validation' corresponds to the irradiation of RPCs operated in an open mode gas system. It serves to optimize and validate the GIF set-up, the RPC chambers and to characterize in detail and individually different filters exposed to exhausted gas from the heavily irradiated RPCs.
2. The period 'Current configuration at LHC experiments' is a long-term, systematic test of the combination of purifiers currently in use in the LHC RPC systems; therefore it aims

at revealing the possible limitations of the current RPC closed-loop gas systems for the future higher luminosity running.

3. The third period is a test of the so-called ‘first optimized configuration’, using a new combination of purifiers.
4. The last period corresponds to the so-called ‘second optimized configuration’, which simplifies the previous filter’s combination while it improves the overall performance of the gas system.

4.1. Optimization of the filters

As a result of the detailed and systematic characterization of each individual filter, it has been found that there is a combination of purifiers that would filter efficiently, in addition to H₂O and O₂, some of the gas pollutants typically present in the irradiated RPC mixture. The so-called ‘first optimized configuration’ consists of four different absorbers (Fig. 15). In comparison to the current LHC configuration:

- It contains the same amount of MS 5Å;
- The MS 3Å has been replaced by 4Å, that permits to reduce the conditioning time and it absorbs more efficiently water (170 g per kg instead of 140 g per kg of purifier) and RPC-related impurities;
- The catalyst CuZn R12 has been removed, as it does not filter any of the radiation-induced impurities. The remaining metallic catalysts double their volume (by using two individual cartridges instead of one) and so their cleaning capacity, especially for O₂; in addition, as each catalyst is now contained in its own physical cartridge, the regeneration and conditioning phases can be optimized;

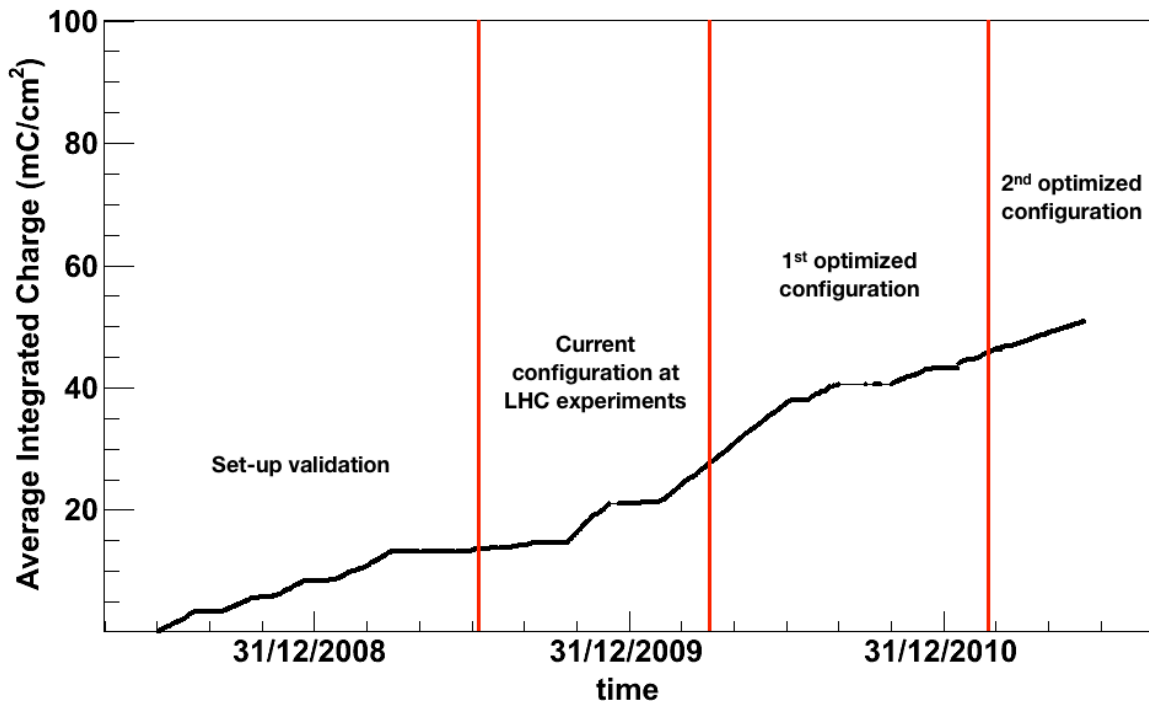

Fig. 14 Average integrated charge seen by the irradiated RPCs from the beginning of the test. Four different time periods corresponding to the test of different purifier configurations are visible.

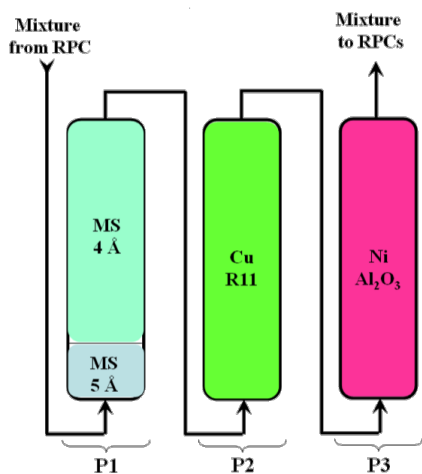

Fig. 15 First optimized configuration.

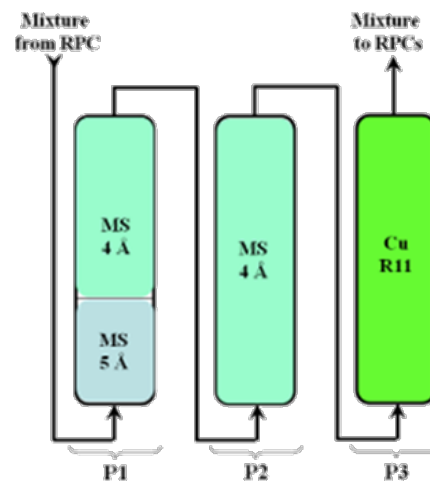

Fig. 16 Second optimized configuration.

In this configuration one disadvantage remains: the low water and Freon-like impurities absorption capacity due to the presence of only one cartridge of MS.

In order to correct this limitation, the second optimized configuration consists of three physical cartridges, two of which have an important abundance of MS 4 Å (Fig. 16). The advantages with respect to the other two configurations are:

- The water absorption capacity is increased by a factor 2, and the increased amount of MS also guarantees an effective filtering of RPC-pollutants.
- The metallic catalyst Ni-Al₂O₃ is abandoned because it has shown that under some conditions can pollute the gas mixture. Cu R11 remains as the unique O₂ filter.

4.2. RPC gas quality using optimized filter configurations

Gas humidity

In order to characterize in detail the impurities produced in heavily irradiated RPCs, and the filtering capacity of several filter configurations, systematic analysis of the composition of the RPC gas mixture by means of the microGC/MSD were carried out daily. Six sampling points are available in the gas system:

- Point 1 (FreshMix): fresh mixture delivered by the gas mixer;
- Point 2 (OMReturn): the gas mixture from the chambers exhaust in the open-mode gas circuit;
- Point 3 (CLReturn): the gas mixture from the chambers exhaust in the closed-loop gas circuit;
- Points 4-5-6 (AfterP1-P2-P3): the gas mixture after the first, second and third purifiers respectively.

In these six points the correct proportion of the gas mixture and the impurities concentration down-stream the detectors are calculated and monitored. Fig. 17 shows a comparison of several gas chromatograms. For the gas mixture extracted after the chambers operated in closed-loop (CLReturn), impurities are clearly visible and their concentration is higher than in the gas from chambers operated in open mode. These impurities, accumulated in the closed-loop return gas mixture, can damage the RPCs and reduce their performances in time.

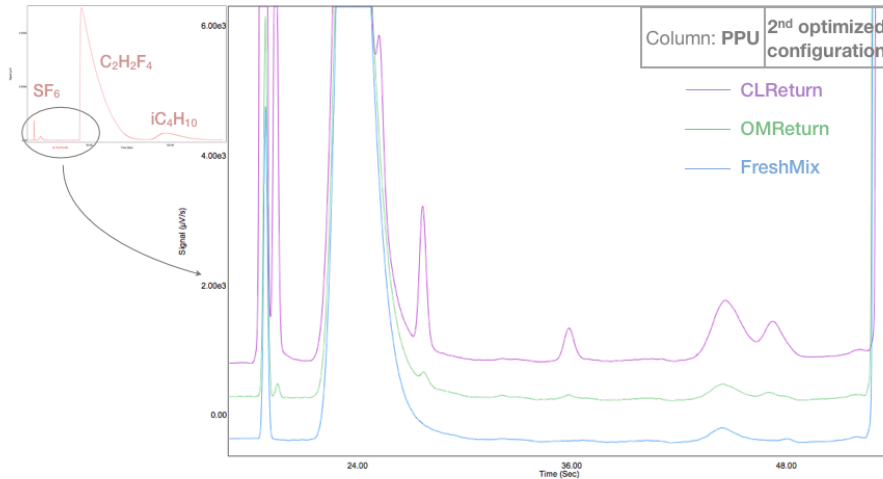

Fig. 17 Comparison between three gas chromatograms (obtained with column PPU) from the following analysis points during the test of the second optimized configuration: fresh mixture gas (FreshMix), gas exiting the irradiated RPC in open mode (OMReturn) and gas mixture after the chamber in closed-loop (CLReturn).

A crucial parameter for the stable operation of RPC detectors is the relative humidity inside the gap. The amount of water vapor quantity injected into the gas should be constant as it helps defining the electrical properties of the Bakelite electrodes. In order to control the relative humidity in the closed-loop, that should be $\sim 40\%$, the water in the gas mixture exhausted by the irradiated chambers is completely removed by means of MS purifiers. Then, the right water concentration is freshly injected in the chambers' supply line.

The concentration of H_2O in the filtered gas (after purifiers 1, 2 and 3, as sketched in Figs 15 and 16) was monitored during all the long test period. In Fig. 18 it can be noticed that in the 'current LHC configuration' and in the 'first optimized configuration' there is about the same amount of water after the purifiers, between 100 and 300 ppm. The highest levels are reached when the MS purifiers are saturated, and slowly decrease to the hundred-ppm level after MS are regenerated or changed. In the 'second optimized configuration' when purifier 1 is saturated (CL1AFTERP1 in Fig. 18) the gas remains dry because the MS 4\AA in purifier 2 still absorbs water well enough. In this configuration, the water concentration inside the gap is easily kept under control and for a longer period (about a factor 2 with respect to 'current LHC and the first optimized configurations').

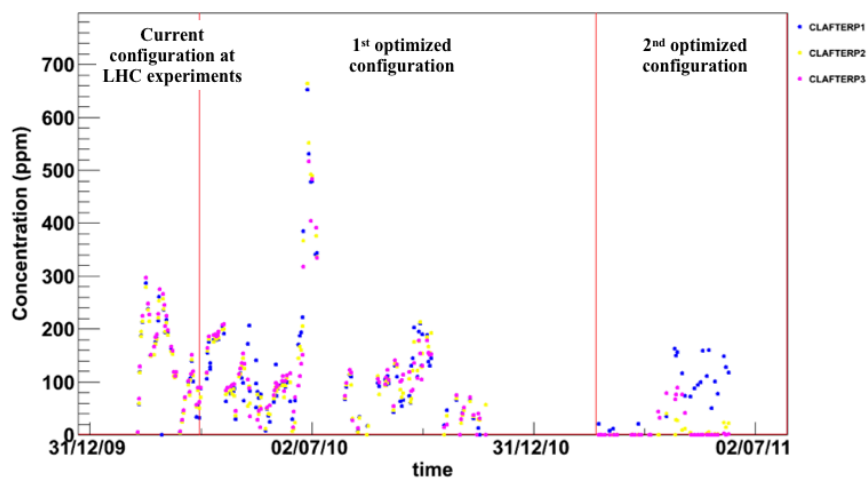

Fig. 18 H_2O concentration after each purifier (dots of different colours) as a function of the time for the three configurations tested at the GIF.

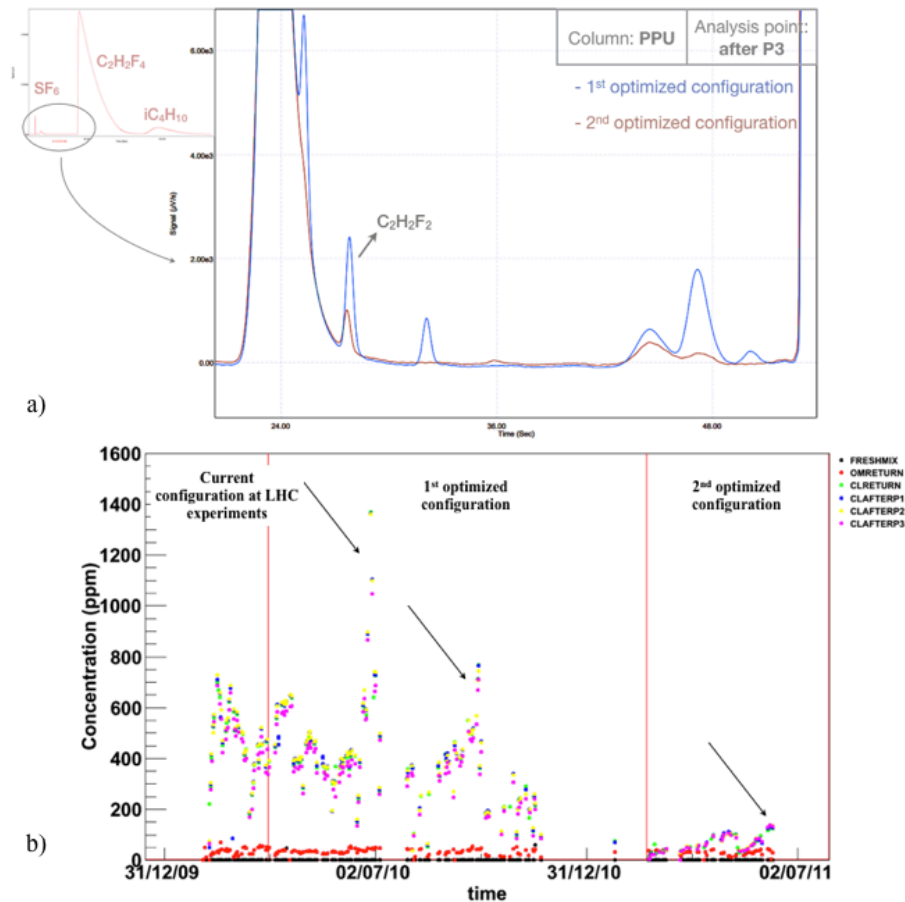

Fig. 19 Example of the analysis results for one impurity ($C_2H_2F_2$). a) Gas chromatograms obtained with the column PPU for the first and second optimized configurations: the peak of $C_2H_2F_2$ is higher for the 1st optimized configuration. b) Concentration of the $C_2H_2F_2$ in the different analysis points: the concentration is lower for the 2nd optimized configuration after each purifier. The arrows indicate the saturation of the purifiers.

Radiation-induced impurities

Another quality of the second optimized configuration concerns the radiation-induced impurities in the gas. Impurities have been constantly monitored during the long test in order to check their presence and concentrations (in general from 100 ppm to 1000 ppm). In the final configuration of filters the impurities show with a lower concentration and some even disappear. Fig. 19 shows the example of one impurity ($C_2H_2F_2$) where this effect is clearly visible.

The monitor of impurities along time is also useful to understand when the purifiers need to be regenerated: the sudden increase of the pollutants concentration is correlated with the saturation of the purifiers.

Fresh gas injection

In the LHC RPC gas systems about 5-10% of fresh mixture is injected in the circulation loop. At the GIF, a systematic study has been done in order to understand how the impurities concentration changes with a different fraction of fresh mixture injected in the presence of the three purifiers. Fig. 20 shows the trend of the percentage of fresh mixture injected in the closed-loop. The attention in this test should be focused on the 'second optimized configuration' test time which can be sub-divided in three periods with different percentages of fresh mixture: 3% (period A), < 1% (period B) and 6% (period C). It has to be considered that at the GIF the dose rate acceleration factor is about 30, so the time period for each test should be multiplied by a factor to possibly obtain a realistic, equivalent operation time in LHC conditions.

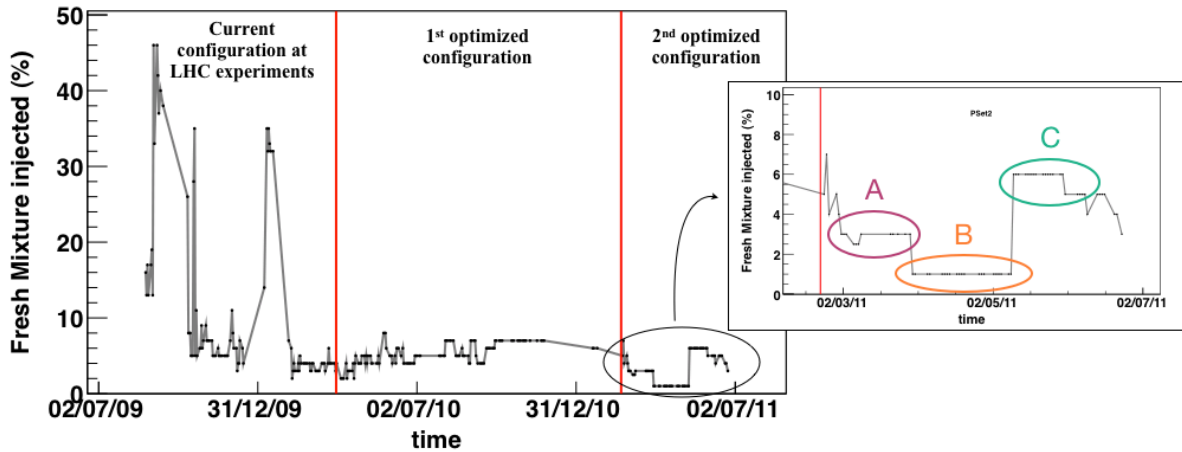

Fig. 20 Percentage of fresh mixture injected in the closed-loop system versus test time. The zoomed region shows the ‘second optimized configuration’ test time which is divided in three periods with different percentages of fresh mixture: 3% (period A), < 1% (period B) and 6% (period C).

Fig. 21 shows the concentration of one of the detected impurities in the RPC irradiated gas. The pollution concentration is lower for the second optimized configuration with respect to the other periods (where the percentage of fresh mixture injected was always about 7%). The impurity concentration gets steadily higher with decreasing fresh gas amount addition. In period C, when 6% fresh gas is injected in the closed-loop, the impurity concentration remains at the same level of its concentration in chambers operated in open mode, which means that the impurity is completely absorbed by the purifiers in the closed-loop. Therefore the injection of the proper amount of fresh gas inside the chamber in closed-loop helps in avoiding an exponential increase of the impurities and it is necessary to safely operate RPC systems.

A test with the closed-loop system operated without purifiers, but just adding 6% fresh gas in the loop, was also performed. After about 6 days of operation, equivalent to few months at LHC, the impurities concentration increased and some new impurities appeared (Fig. 22). Furthermore the water concentration inside the gap could not be kept under control.

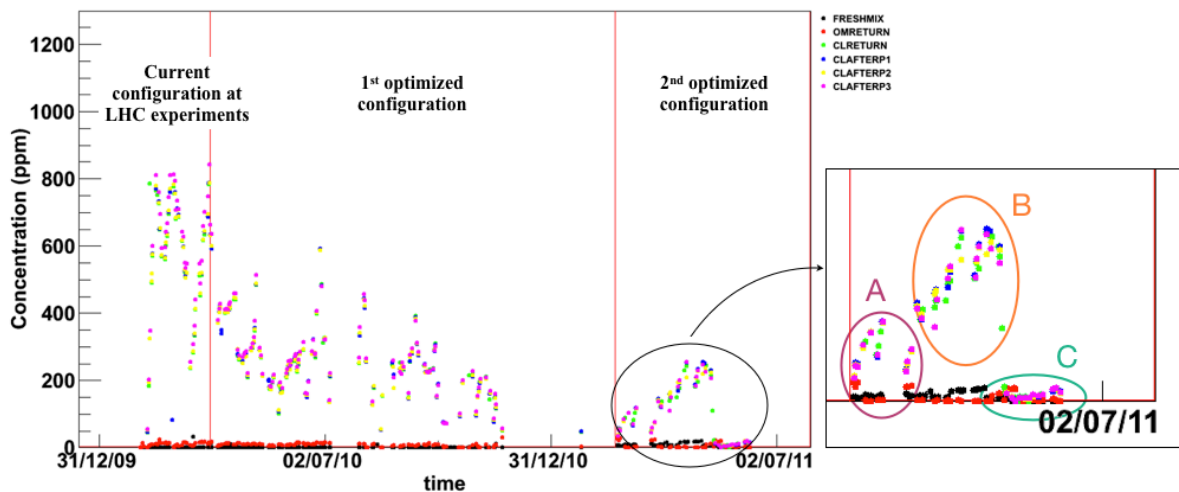

Fig. 21 Concentration of one impurity vs. time during the GIF test. The zoomed region represents the concentration during the test period for the second optimized configuration.

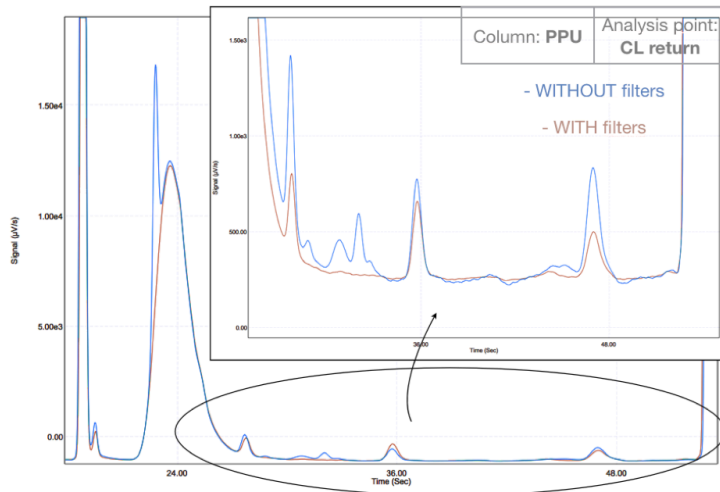

Fig. 22 Gas chromatograph of the gas exhausted by the chambers and being re-circulated in the test without purifiers; the concentration of known impurities increase and few new components appear.

4.3. Long-term performance of the RPCs irradiated at the GIF

During the many months exposing the RPC detectors to the high-intensity gamma source at the GIF, an integrated charge of 50 mC/cm^2 , equivalent to about 10 years of operation in the CMS RPC barrel region, has been accumulated. This achievement is very useful to understand the RPC performances and their behavior over the next LHC running periods. The performance of the detectors has been monitored in terms of Bakelite bulk resistivity and current stability over time.

Bakelite bulk resistivity

The Bakelite bulk resistivity has a great impact on the RPC performances, especially at very high particle rate where an important voltage drop can occur if the resistivity of the Bakelite electrodes is too high. At the GIF, the RPC resistivity is regularly measured in order to check its stability during all the operation time.

Fig. 23 shows the Bakelite bulk resistivity measured for each irradiated gap at different time periods. The x-axis shows the gap number; gaps -1 to 4 are operated in open mode, while gaps 5 to 10 in closed-loop. For almost all gaps there is a visible increase of a factor 3-5. However, gaps 5 to 8 do not show any significant change with respect to the original values.

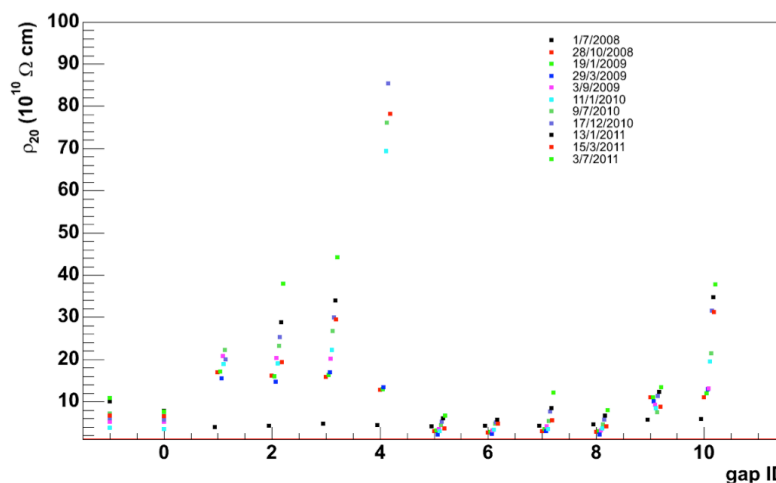

Fig. 23 Bakelite electrode bulk resistivity (normalized at $20 \text{ }^\circ\text{C}$) for all the detectors measured at different time periods. An average increase of about a factor 3-5 is visible in all gaps, with the exception of gaps 5 to 8.

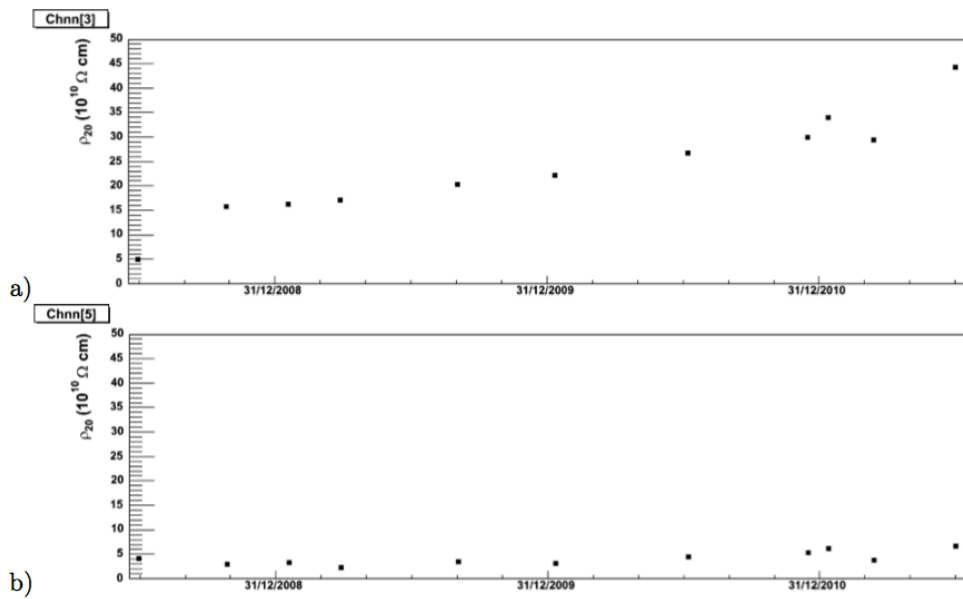

Fig. 24 Different behaviours of HPL bulk resistivity versus time for two RPC detectors: a) increasing and b) stable trend.

Fig. 24 shows as an example, the time evolution of the HPL resistivity for a gap showing an increasing (gap 3, Fig. 24 a) and one with a stable behavior (gap 5, Fig. 24 b). It is noticeable that for gap 3 most of the increase occurred during the first months of operation. The different behavior of gaps irradiated under identical conditions has been already observed in earlier tests [4]. Any correlation with the gas system operation (i.e. open mode or closed-loop) and the mixture relative humidity (i.e. constant to 40% for all gaps) at this stage can be excluded.

During the measurement of the bulk resistivity also the high voltage corresponding to the onset of the typical unquenched discharge was monitored to check the stability of the detectors' performance. If the properties of the gas in the RPC remain stable, this voltage represents an undirected measurement of the minimum gas gap width. Any deviation from a constant behavior can be an indication of a deterioration of the electrode internal surface. Fig. 25 shows an example of the time evolution of this parameter for one detector irradiated at the GIF. The measured values are constant and only small fluctuations are visible and most probably related to change in the relative humidity of the gas used during the test.

Gas gain long-term stability

The RPC current is a fundamental parameter to be monitored because its stability indicates that the RPC detector is working properly. Any variation represents a change in the detector gas gain.

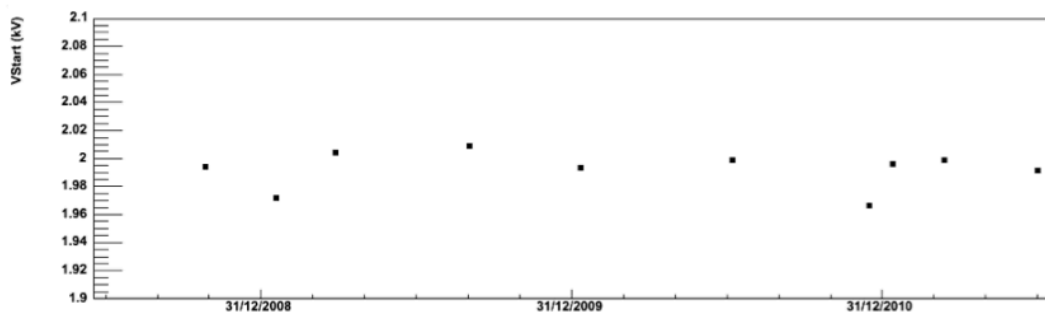

Fig. 25 Switch on high voltage with Argon for one RPC detector. This parameter can be an indirect measurement of the minimum gas gap width.

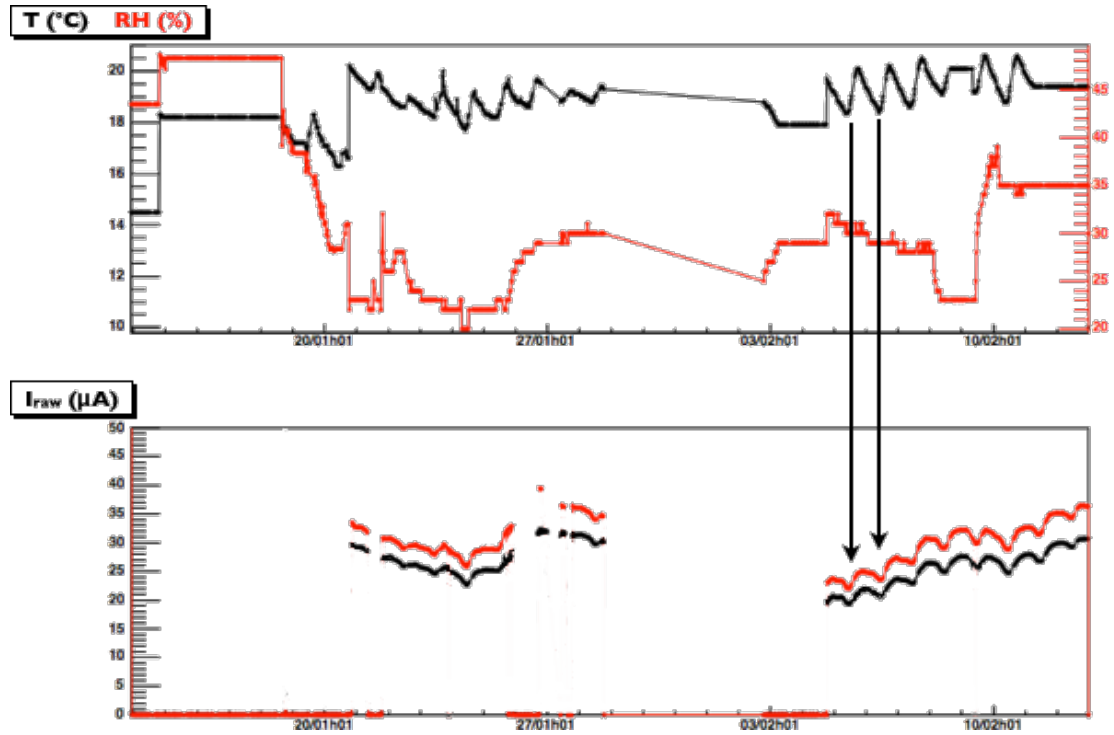

Fig. 26 Trend of the environmental parameters (temperature and relative humidity) and of the raw current of two RPC gaps at the GIF. In the period in which the current is zero, the detectors were not working. It is visible a correlation between temperature and current.

The gas gain depends on the condition of the gas, which can be altered by temperature and pressure variations. A possible correction can be applied leaving the High Voltage (HV) fixed, letting the current free to follow the environmental variations and applying later a correction that takes into account all possible mechanisms related to environmental fluctuations. Fig. 26 shows the raw current and environmental parameters trends: it is visible a correlation between the current and temperature trends.

The most general and empirical formula we tested is the following:

$$I_{corr} = I_{raw} \left(\frac{P}{P_0} \right)^{F_1} \left(\frac{T_0}{T} \right)^{F_2}$$

where F_1 and F_2 are coefficients which minimize the chi square in the formula while $P_0 = 1000$ mbar and $T_0 = 20$ °C are taken as reference values. This equation has also the advantage of including the correction for all possible effects also related to changes in the Bakelite electrical properties due to variations of temperature and relative humidity. Fig. 27 shows the current drawn by an irradiated RPC before and after the environmental correction is applied, resulting in a RPC that behaves remarkably stable over the whole irradiation time.

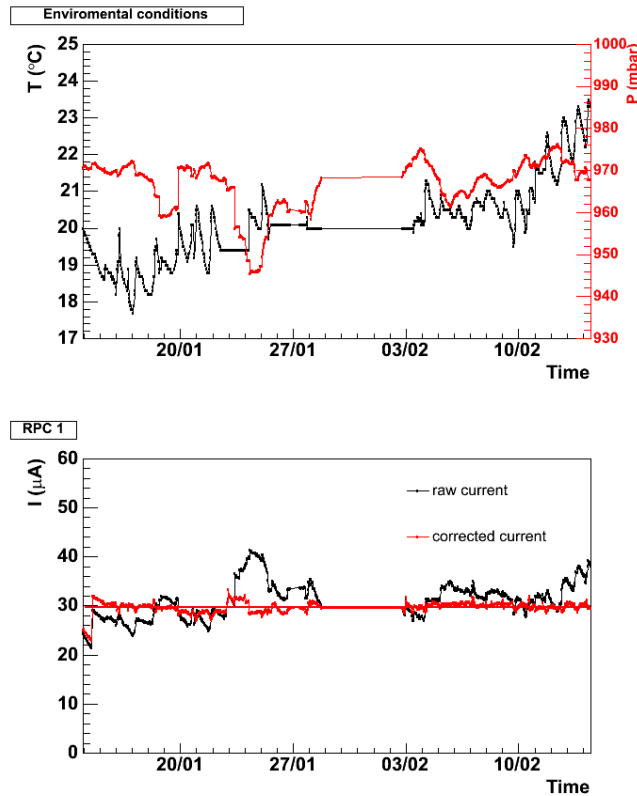

Fig. 27 (top) Environmental temperature and pressure during the test time, and (bottom) trend of the raw and corrected current drawn by the irradiated RPC.

5. Implementation of the optimized filter's configuration at LHC

In the RPC gas systems of ATLAS and CMS, currently the purifier module consists of two identical units, each as shown in Fig. 13. In order to upgrade the systems to implement the new filters configuration, a third purifier unit has been constructed and installed.

Fig. 28 shows a picture of the new installation in the CMS- SGX building.



Fig. 28 Pictures of the front 3 purifier unoitns newly installed in the CMS-SGX building, and of the back of one purifier unit, where the double-column system in each purifier unit is visible.

The 5–6 m³/h returned gas from the chambers in the cavern is collected and, by means of a circulation pump, it is sent to the purifier module located in the surface. The two purifier modules are connected in series, i.e. the return mixture flows through each unit in sequence. After the last unit, the mixture is re-injected into the circulation loop with the addition of a small percentage of fresh gas.

Each purifier module contains two identical columns of 24 l. One is in operation while the second one is being regenerated or in standby. Fig. 29 shows the PVSS control panel of one purifier module. It shows how column A is in run state, while column B is in regeneration. The panel also monitors several parameters like the gas flow passing through the columns, the temperature of the columns (about 220 °C during the regeneration), the position of the valves, etc. The PVSS also changes the column automatically when saturated: a sensor registers the gas volume passed through the column and when it reaches a specific set value, it switches the column in run with the other one and starts the regeneration of the former. Several studies have been conducted in order to choose the correct amount of gas to flow in the column until its saturation. Each column has a capacity of 24 l and a gas flow of 5–6 m³/h: with these values it is possible to calculate the duration of each cycle, as it was shown in Table 3. The software panel has a counter which registers the number of regenerations: in this way it is simple to understand when the column filters need to be changed. Currently, Purifier 1 lasts about 1 year while Purifier 2 is in use for about 80 weeks.

The optimized configuration of filters will be tested in the final systems during the 2013-2014 LHC shutdown, and will be operational for the high-luminosity LHC running.

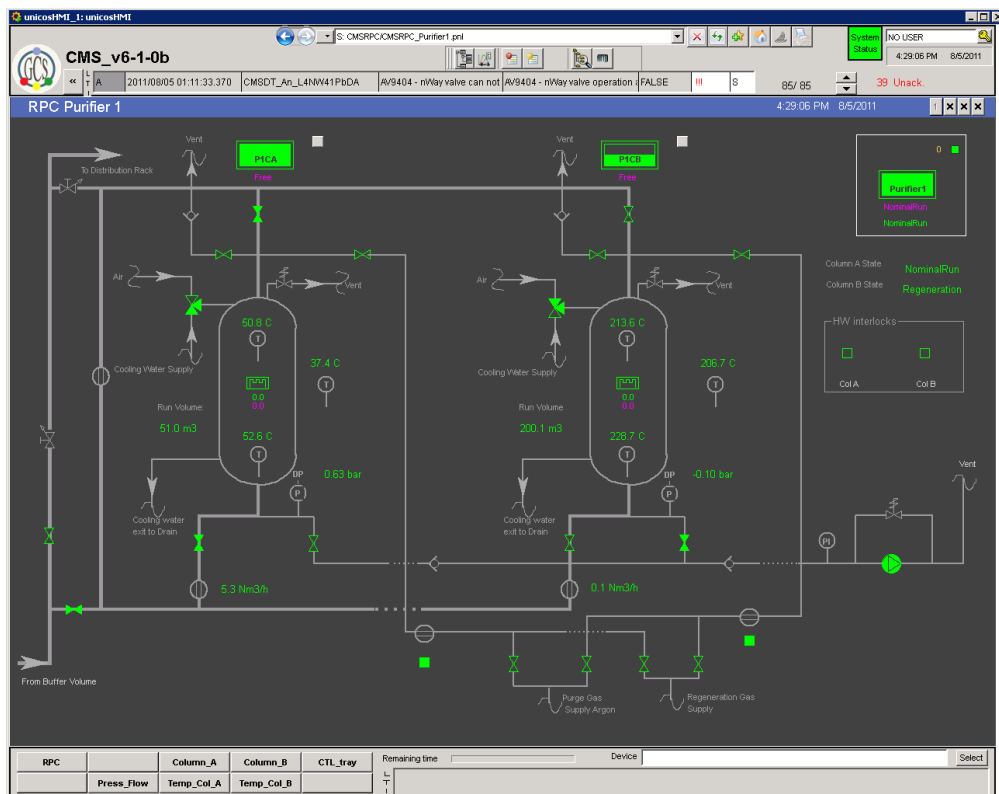

Fig. 29 The PVSS control panel for the operation of the purifiers. This image shows the control panel unit for the RPC first purifier where the two columns are clearly visible.

6. Conclusions

Due to the large detector volume and the use of a relatively expensive gas mixture, the large RPC muon trigger systems at the LHC experiments are operated in closed-loop gas systems with about 90-95% re-circulation rate. However, many studies have proven the presence of numerous impurities in the return gas from detectors operated under irradiation, and their detrimental effect on the detectors' performances.

Several tests have been performed in order to obtain:

- a systematic and detailed characterization of the effectiveness of several gas cleaning-filters;
- a detection, quantification and identification of the extra-components in the RPC gas mixture created during the harsh irradiation of detectors;
- a complete understanding about performances and limits of the original purifiers configuration in the RPC gas system currently operating at LHC;
- a systematic study of two, new optimized filter configurations that keep the gas of RPC systems operated at high luminosity near the quality of fresh gas mixtures .

The 12 large-size RPCs operated at the GIF have been fully exposed to substantial irradiation for about 3 years, corresponding to about 10 years of operation in the LHC systems. During this period several RPC parameters were monitored in order to control the RPC performance.

After a first period dedicated to set-up validation, a systematic study has been done to understand in detail the gas system performance as currently being used at LHC. The result reveals a system not well optimized due to some limits on the purifiers filtering capacity and performance. The full characterization of several purifier materials brought to a complete understanding of their filtering capacity, which allowed the implementation of two optimized configurations. Both configurations were tested at the GIF for a period of one year each. The aim was to find further improvements and to identify the best implementation for the LHC gas systems.

We can conclude that a combination of MS 5Å and 4Å together with Cu R11 is in perfect agreement with the requirements of the large RPC gas systems at the LHC experiments for the following reasons:

- Water is completely filtered, and this allows to re-inject the correct quantity of H₂O in the gas mixture to maintain constant the Bakelite bulk resistivity.
- One metallic catalyst, Cu R11 is enough to adsorb the O₂ present.
- In this combination, the purifiers cycle duration is 7 days for O₂ and 3.5 days for H₂O, increased a factor 2.5 with respect to the current LHC configuration.
- This combination of filters improves the purifiers run cycle (and consequently the reduction of the number of regenerations) and the filtering performances for the RPC system at LHC, in particular purifier modules can easily handle an increase of a factor > 1.5 in flow if needed during LHC high luminosity runs.
- This combination removes most gas pollutants created in the irradiated RPCs and accumulated in closed-loop circulation. Impurities concentration is well below 500 ppm with efficiently working purifiers, and it amount is correlated with the level of saturation of the purifiers;
- The performance of heavily irradiated RPCs seems to be unaffected at long-term by the achieved low concentration of impurities. After correction for changes due to environmental conditions (current fluctuations induced by pressure and temperature variations), the currents drawn by the RPCs connected to the optimized closed-loop gas system have been very stable over the entire test period (Fig. 30).

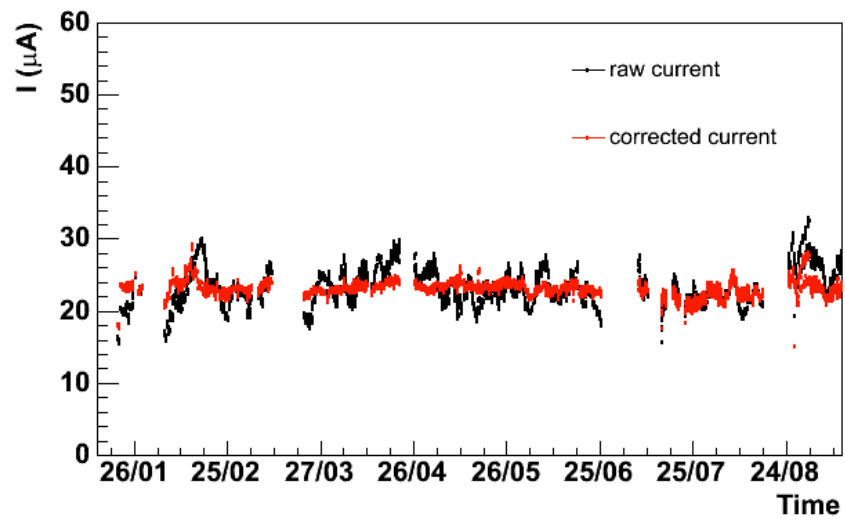

Fig. 30 Trend of the raw and corrected current drawn by the irradiated RPC for all the test period of the 'second optimized configuration' of filters.

7. Bibliography

- [1] M. Capeans et al., *Optimization of a closed-loop gas system for the operation of Resistive Plate Chambers at the Large Hadron Collider experiments*, 2009 IEEE Nuclear Science Symposium Conference Record N11-6, 2009.
- [2] M. Bosteels et al., *CMS Gas System Proposal*, CMS Internal Note CMS IN 1999/018 (1999).
- [3] S. Altieri et al., *The Bakelite for the RPCs of the experiment CMS*, Nucl. Instr. and Meth. A 456 (2000) 132.
- [4] M. Abbrescia et al., *Results about HF production and bakelite analysis for the CMS Resistive Plate Chambers*, Nucl. Instr. and Meth. A 594 (2008) 140.
- [5] Leuna. *Catalyst 6525 technical specifications*, 2011.
- [6] M. Boostels et al., *Experimental study on oxygen and water removal from gaseous streams for future gas systems in LHC detectors*, CERN, EST Internal Note, 2000.
- [7] M. Capeans et., *Studies of purification of the Resistive Plate Chamber gas mixture for the Large Hadron Collider experiments*, 2008 IEEE Nuclear Science Symposium Conference Record N02-165, 2008.