

HIGH  $P_T$  AND JETS

M. Jacob

CERN, Geneva, Switzerland

ABSTRACT

Recent developments in the field of high- $p_t$  hadronic interactions are reviewed. They mainly refer to the jet structure of reactions with high- $p_t$  secondaries and to the properties of hadronic jets. The relevance of quantum chromodynamics is assessed and a data-sampling illustrates successes and present problems. The question of prompt photons at high  $p_t$  is discussed. Recent results on wide angle  $\pi p$  elastic scattering are presented.

1. INTRODUCTION

Particle production at high transverse momentum (high  $p_t$ ) has attracted much interest since the discovery of anomalously important yields at the CERN ISR in 1972. It is now well known that large- $p_t$  secondaries are associated with a jet structure. The typical configuration is shown in Fig. 1.a). Two jets of hadrons are produced at wide angle, while forward and backward jets are also present, as is usually the case for hadronic reactions. The association of the two wide angle jets with the hard scattering and fragmentation of hadron constituents, as long discussed in the framework of the parton model (Fig. 1.b)), has now gained general currency. All expected features have been met with impressive success<sup>1)</sup>. At present, quantum chromodynamics, as it can be used in its perturbative approximation, provides an attractive theoretical framework for a deeper understanding of the success of the parton model<sup>2,3,4)</sup>. It allows for the computation of rates and predicts deviation from the too simple picture usually associated with the parton approach. While some semi-quantitative success can already be claimed, and while general agreement prevails that QCD subprocesses take a dominant rôle at very large  $p_t$  ( $p_t > 10$  GeV/c), the situation is still unsettled. We are lacking data at collider energies ( $\sqrt{s} \approx 500$  GeV) which alone could provide full confidence in the QCD approach. Data should become available by 1981. Where plenty of data is already available (at  $p_t \sim 5$  GeV/c say), QCD predictions have to involve too much parametrization of yet poorly understood effects to be amenable to any actual test. One also encounters evidence for some correlations which QCD is unable to meet in its simple "leading log" implementation and which may imply the relevance of more complicated effects, referred to as higher twist effects in the present vernacular.

We are at an interesting transition stage and the time which has elapsed since the Copenhagen meeting on "Jets in High Energy Collisions"<sup>5)</sup> and the Tokyo Conference<sup>6)</sup>, which were the two landmarks in this field in 1978, has been a time of consolidation rather than a period during which new views or new challenges have emerged. At present there are far more precise and extensive data than was available at the time of the Tokyo Conference<sup>7)</sup>. They are however basically supporting the jet picture which could already be claimed

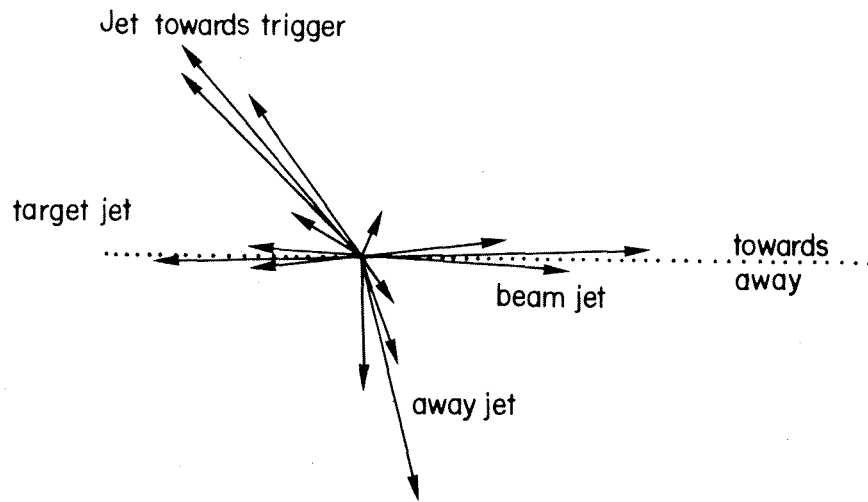

Fig. 1.a) : An idealized picture showing the two wide angle jets associated with the fragmentation of the scattered constituents. Also shown are the forward and backward jets typical of hadronic interactions.

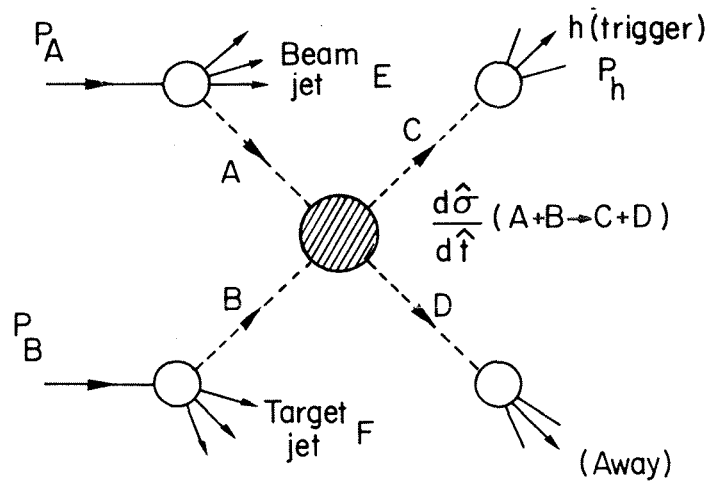

Figure 1.b) : The hard scattering approach to high- $p_t$  production. Constituents A and B scatter into constituents C and D. The trigger particle is a fragment of constituent C.

as established by then. Insofar as these data provide stronger and wider support for the hard-scattering approach, they are a strong encouragement for further studies through which the nature, the relative rôle and the fragmentation modes of the relevant constituents should be established with some precision. Insofar as they certainly agree, at least at a qualitative level, with expectations based on QCD, there are as many challenging pieces of evidence for a more refined theoretical approach and as many sources of great expectation when considering experimentation at much higher energies.

The amount of new material is such that this review simply cannot do justice to all recent and interesting results. It is organized as follows. A data-sampling, aimed at illustrating the still better evidence for the jet structure which is now available, is first presented. This can be done without any specific reference to the nature of the relevant hadron constituents. We then turn to the study of recent experimental information which is more related to the actual nature of the basic mechanisms at work. Hints at QCD subprocesses becoming dominant at very high  $p_t$  are first reviewed. Evidence for this relies primarily upon the highest  $p_t$  data available, which correspond to inclusive  $\pi^0$  production. We then turn to a data-sampling again, choosing among recent results illustrating the complexity of the subprocesses or of correction terms rather than the overall simplicity which prevails at first sight. This has to do with specific effects expected in the framework of perturbative QCD. This has also to do with effects which could be associated with more complicated terms only, but which can be presently parametrized in terms of specific subprocesses. One of them is the well-known constituent interchange model (CIM)<sup>1,8)</sup>. We conclude this review of high  $p_t$  and jets with the question of prompt photons at high  $p_t$ . It is a common feature of all models based on hard scattering among hadron constituents that the  $\gamma/\pi$  ratio should be much larger than  $\alpha$ , and increase with  $p_t$  or more accurately with  $x_t = 2p_t/\sqrt{s}$ . Collecting evidence for a prompt photon component among an overwhelming background of  $\pi^0$  and  $\eta$  decays has however long been a challenging experimental question. Evidence for a prompt photon yield with a  $\gamma/\pi$  ratio increasing with  $p_t$ , and at the 20% level at  $p_t = 6$  GeV/c, has now been reported.

Our present understanding of high- $p_t$  processes is closely related to that of the energy behaviour of elastic scattering at fixed wide angle<sup>1)</sup>. It is therefore deemed appropriate to close this report with some recent results on  $\pi$ -nucleon scattering in the 45 - 90° angular range. Even though the maximum beam energy is only 30 GeV, the relevant  $p_t$  is rather large by present standards.

## 2. THE JET STRUCTURE

Seldom are jets as clearly seen as in the actual event shown in Fig. 1.c). The peculiar (and now well understood) effect that most of the jet momentum on the trigger side is actually carried by the high- $p_t$  particle used as a trigger notwithstanding, one is very close to the idealized picture of

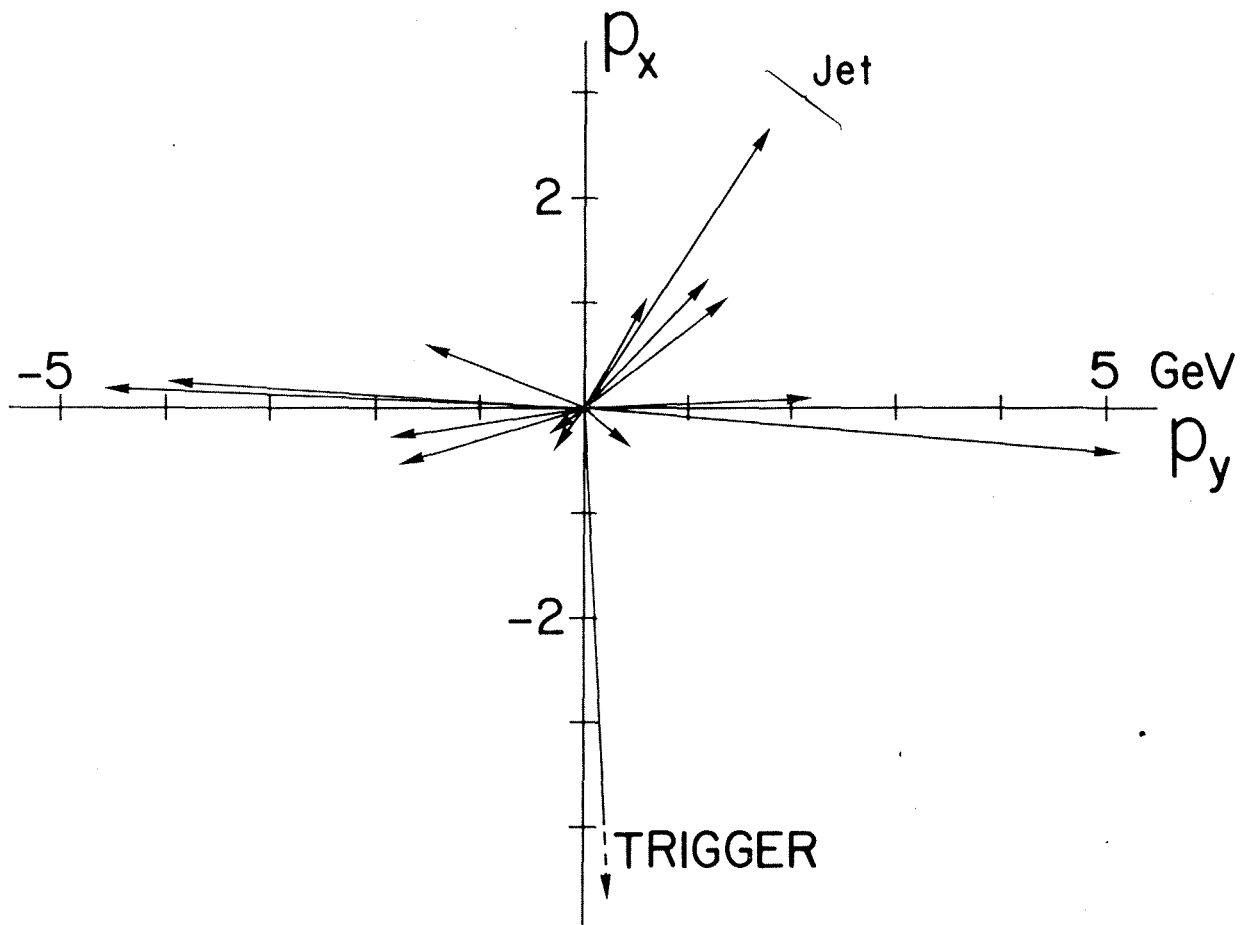

Fig. 1.c) : An event observed by the British-French-Scandinavian Collaboration at the ISR (R 413). A charged pion (with  $p_t \approx 9$  GeV/c) acts as a trigger. A jet of hadrons at wide angle is clearly seen on the other side even though only charged particles are recorded.

Fig. 1.a). Evidence of a jet structure more generally results from a now very wide array of correlation data<sup>1,5,6)</sup>. Focussing on relatively high- $p_t$  particles, which are more directly associated with the expected jets, one may first test for the angular (or rapidity) correlations which they must have among themselves as members of jets. We shall however not come back on evidence for jet-like rapidity correlations on the towards and on the away sides, which in standard vernacular are defined with respect to the detector used at triggering. No doubts remained already at the time of the Tokyo Conference<sup>9)</sup>. We choose rather to present new data which better test the coplanarity structure of high- $p_t$  reactions. All large- $p_t$  particles should be in the plane defined by the hard-scattering subprocess. This simple (standard) jet picture is however not meant to exclude more complicated configurations, with for instance a third jet, the presence of which would spoil the coplanarity structure. In the framework of perturbative QCD this should also occur and we shall come back to it. The data displayed in Fig. 2 indicate that, up to a good level of approximation, there is no evidence against the coplanarity structure associated with the standard jet picture which one should at least contemplate for a while<sup>10)</sup>. Figure 2.a) presents recent data from the Athens-Brookhaven-CERN-Syracuse Collaboration on azimuthal correlations among two high- $p_t$   $\pi^0$ 's<sup>11)</sup>. In an attempt to minimize what is expected by kinematical consideration alone, data are presented for increasing values of  $E_t$ , the global energy radiated transversally. In practice it is that of the two observed  $\pi^0$ 's together with whatever is needed to balance the resulting transverse momentum. This is to be contrasted to a presentation of the data in terms of the observed transverse momenta which would force a coplanarity structure as favoured anyway in view of sharply falling rates with increasing  $p_t$ . Back-to-back peaks appear in the azimuthal correlations as the only prominent feature. Figure 2.b) shows recent data from the CERN-Saclay Collaboration at the ISR<sup>12)</sup>. Displayed are the ratios of rates for the observation of fixed numbers  $N$  of charged particles for events selected by the observation of a high- $p_t$   $\pi^0$  ( $p_t > 5$  GeV/c) and for "minimum bias" events. This is done toward and away from the trigger direction and also out of the plane. One clearly sees the increase expected from the presence of jets in the reaction plane, while nothing changes out of the plane.

Evidence for a jet structure has to go beyond angular correlations. In the standard jet picture one expects that particles associated with either jet should have but a limited transverse momentum with respect to the reconstructed jet axis. There was already some supporting evidence at the time of the Tokyo Conference<sup>5,6)</sup>. More recent data confirm it and provide even more precise tests. Figure 3 illustrates progress made with some recent results from the CERN-Columbia-Oxford-Rockefeller Collaboration. They refer to the structure of the away side jet<sup>13)</sup>. Figure 3.a) shows the axial symmetry of the jet. The distributions of jet fragments around the reconstructed jet axis (the away side jet) are shown for different cuts applied to the transverse momentum of the associated secondaries, the cutoff value increasing as one moves towards the centre. The axial symmetry remains. The angu-

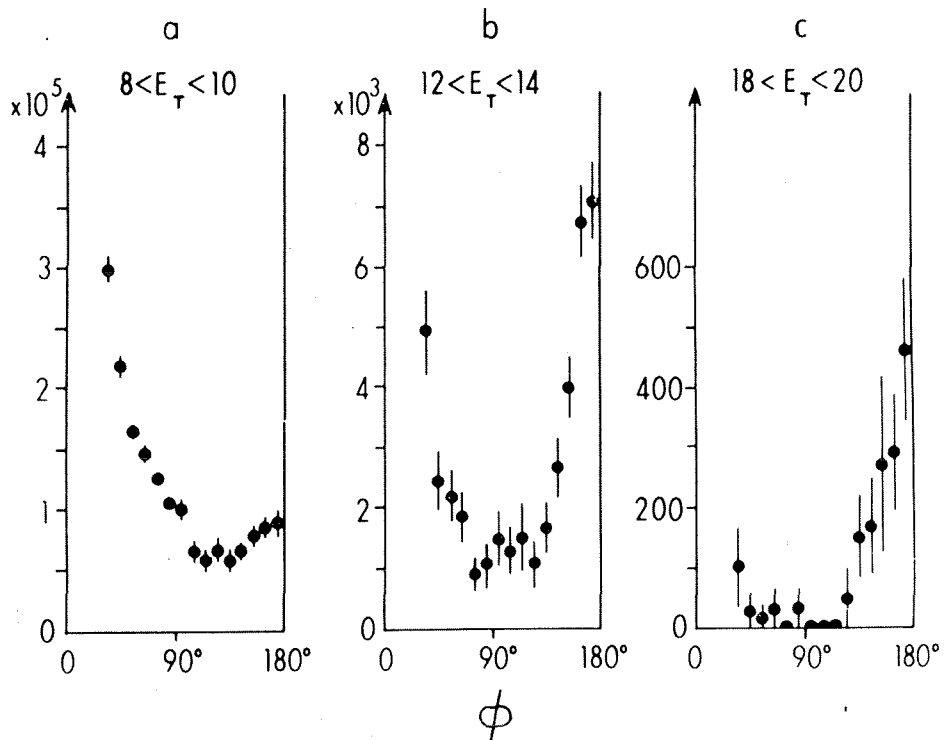

Figure 2.a) : Azimuthal correlation between two high- $p_t$   $\pi^0$ 's for fixed values of  $E_t$ , the energy radiated transversally. It includes that of the two observed  $\pi^0$ 's together with whatever momentum is needed to balance their transverse momenta. Data from the Athens-Brookhaven-CERN-Syracuse Collaboration, Ref. 11.

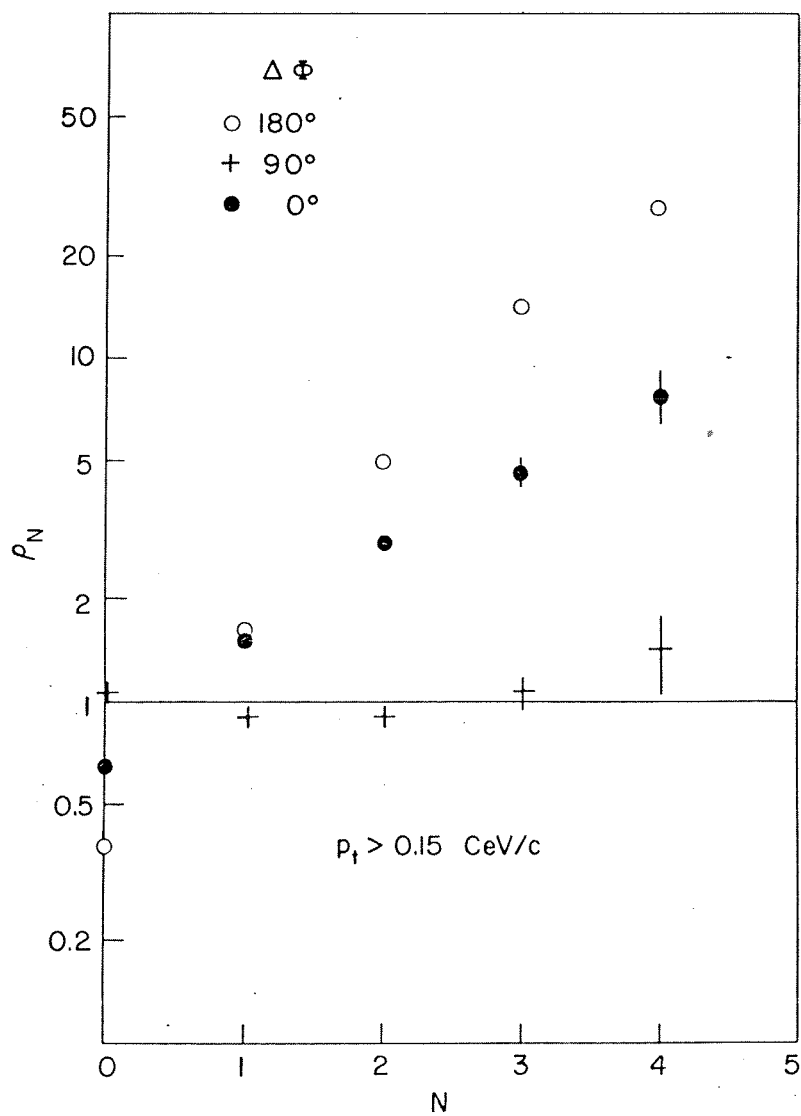

Figure 2.b) : Frequency ratio for the observation of a fixed number of charged particles, between reactions with a high- $p_t$   $\pi^0$  ( $p_t > 5 \text{ GeV/c}$ ) and typical hadronic reactions. The number of associated secondaries increases in the trigger plane (toward and away). Nothing changes out of the plane. Data from the CERN-Saclay Collaboration, Ref. 12.

Azimuthal Distribution of Charged Particles around  
the Away Jet Axis (Different Bands of  $P_{T \text{ TRACK}}$ )

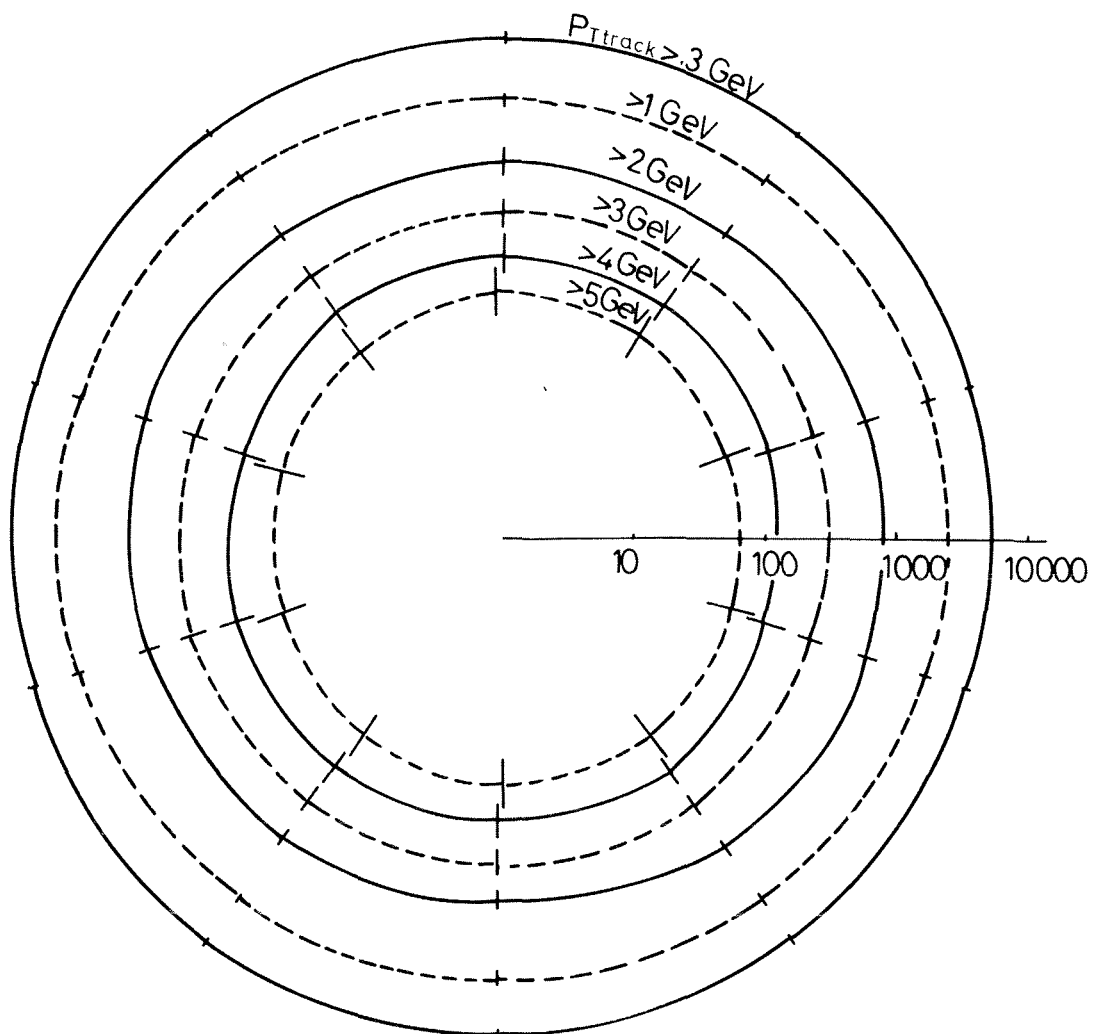

Figure 3.a) : Angular distribution of jet fragments around the reconstructed jet axis for different transverse momentum cutoff and relative yields. Data from the CERN-Columbia-Oxford-Rockefeller Collaboration, Ref. 13.



lar correlation also becomes sharper as the transverse momentum increases. This actually corresponds to a limited mean transverse momentum  $\langle k_t \rangle$  with respect to the jet axis, as shown in Fig. 3.b). The mean value is practically constant as the trigger momentum is varied over a wide range.

New results on  $\langle k_t \rangle$  have also been obtained by the CERN-Saclay Collaboration<sup>12)</sup> though directly accessible to them is the component of the transverse momentum with respect to the jet axis which is in the reaction plane only. Using axial symmetry, as demonstrated by the CERN-Columbia-Oxford-Rockefeller Collaboration (Fig. 3.a)), they quote  $\langle k_t \rangle = 0.55 \pm 0.05$  GeV/c in very good agreement with the data displayed in Fig. 3.b). Such a value of  $\langle k_t \rangle$  can be considered to be in reasonable agreement with values reported in  $e^+e^-$  annihilation, provided that the comparison is made at large enough a value of  $x_L$  in order to eliminate the seagull effect which forces the global mean value down. At  $x_L \sim 0.2$  say, preliminary data from PETRA seem to indicate a slow rise with energy, with  $\langle k_t \rangle \approx 0.45$  at 13 GeV and  $\langle k_t \rangle \approx 0.55$  at 27 GeV<sup>14)</sup>. While jets in hadron interactions may appear to be slightly wider than those observed in  $e^+e^-$  annihilation at the same momentum, one should at present rather stress the overall agreement between the measured values of  $\langle k_t \rangle$  in very different processes. Indeed, there is good agreement between the ISR values of  $\langle k_t \rangle$  and values reported for deep inelastic neutrino scattering<sup>15)</sup>.

At present jets observed in hadron collisions meet properties associated with standard jets<sup>10)</sup>. While there is no supporting evidence for the widening expected in the framework of QCD where the  $\langle k_t \rangle$  distribution should eventually develop an unbounded component increasing as  $p_t$  at order  $\alpha_s(p_t^2)$ , it is however easy to convince oneself that the  $p_t$  values under study are still too low for such an effect to clearly appear over the distribution which merely parametrizes the hadronization of the jet, with a Gaussian shape often used<sup>16,17)</sup>.

Having ascertained angular correlations implied by a jet structure and a prominent jet property with a limited mean transverse momentum for jet fragments (Fig. 3.b)), we now turn to other expected jet properties. The fragments of a jet, among which  $\pi$  mesons dominate, should show a scaling distribution, each taking on the average a fixed fraction of the jet momentum. Figure 4.a) shows how scaling works for the fragments of the towards jet thus accompanying the trigger particle. The data, from the CERN-Saclay Collaboration, show the distribution in longitudinal momentum for charged secondaries associated with a high- $p_t$  neutral trigger (one or several particles), scaled according to the trigger momentum. The distribution does not change as the trigger momentum varies from 5 to 8 GeV/c. Each associated particle carries on the average a fixed fraction  $z$  of the trigger momentum<sup>12)</sup>.

In order to better illustrate what is implied by scaling it is useful to write the expected distributions as they appear in a simplified model where an inverse power behaviour ( $p_t^{-n}$ ) is used to approximate the inclusive

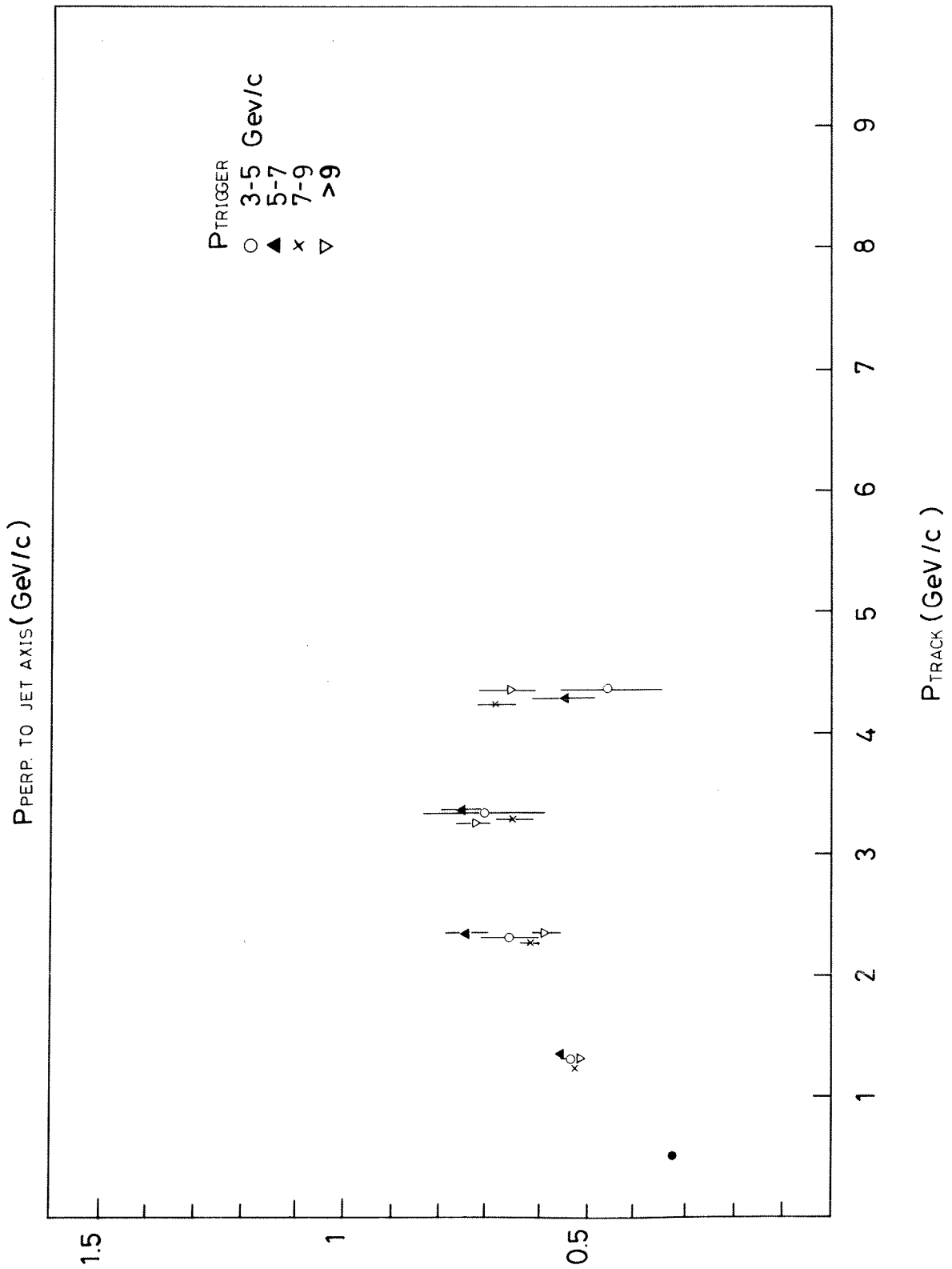

Figure 3.b) : Mean transverse momentum of jet fragments with respect to the jet axis for different trigger momenta. Data from the CERN-Columbia-Oxford-Rockefeller Collaboration, Ref. 13.

distribution at high  $p_t$  and where scaling distributions  $F^i(x)$ ,  $F^{ij}(x_1, x_2) \dots$  are introduced for each fragmentation mode<sup>18)</sup>. The distribution presented in Fig. 4.a) then simply reads:

$$\frac{1}{N} \frac{dN}{dz} = \frac{\int_0^1 x^n F(x, zx) dx}{\int_0^1 x^{n-1} F(x) dx} \quad (1)$$

i.e. a function of  $z$  only (Fig. 4) with a numerical value depending much on the high  $x$  behaviour of the fragmentation functions.

Before claiming that scaling is well established one should however mention that the CERN-Columbia-Oxford-Rockefeller Collaboration does not concur to such a conclusion<sup>13)</sup>. Observing charged particles associated to a neutral trigger they rather find that  $\langle z \rangle$  falls with  $p_t$  (the distribution does not scale). The variation corresponds to about a factor 2 between 5 and 10 GeV/c<sup>19)</sup> (Fig. 4.b)).

Though some evidence for scaling can be reported combining observations from different experiments, more work is certainly needed.

On the away side, general agreement prevails and all available results (many in number) show a scaling distribution provided that the trigger momentum is large enough ( $p_t > 3$  GeV/c). One usually defines a variable  $x_e$  which is the fraction of the trigger momentum compensated by each observed secondary. Taking again the simplified model previously mentioned, and now assuming that the two jets balance exactly their transverse momenta<sup>18)</sup> the distribution presented in Fig. 5) reads:

$$\frac{1}{N} \frac{dN}{dx_e} = \frac{\int_0^1 x^n F(x) F(xx_e) dx}{\int_0^1 x^{n-1} F(x) dx} \quad (2)$$

i.e. a function of  $x_e$  only and, in practice, much different from  $F(x_e)$ .

Figure 5.a) shows recent data from the Athens-Brookhaven-CERN-Syracuse-Collaboration, which are those extending over the largest  $p_t$  range. They clearly demonstrate that, for each  $x_e$  value, the observed rate on the away side is independent of the trigger momentum. There was already good evidence for scaling at the time of the Tokyo Conference<sup>4,5)</sup>. It is now overwhelming, as extensive data at very high  $p_t$  are available<sup>11,12,13)</sup>.

Figure 5.b) puts together ISR results already presented at the Tokyo Conference (CERN-Collège de France-Heidelberg-Karlsruhe Collaboration at lower  $p_t$  and British-French-Scandinavian at larger  $p_t$ , together with the new 8 GeV/c points from the CERN-Columbia-Oxford-Rockefeller Collaboration. Sca-

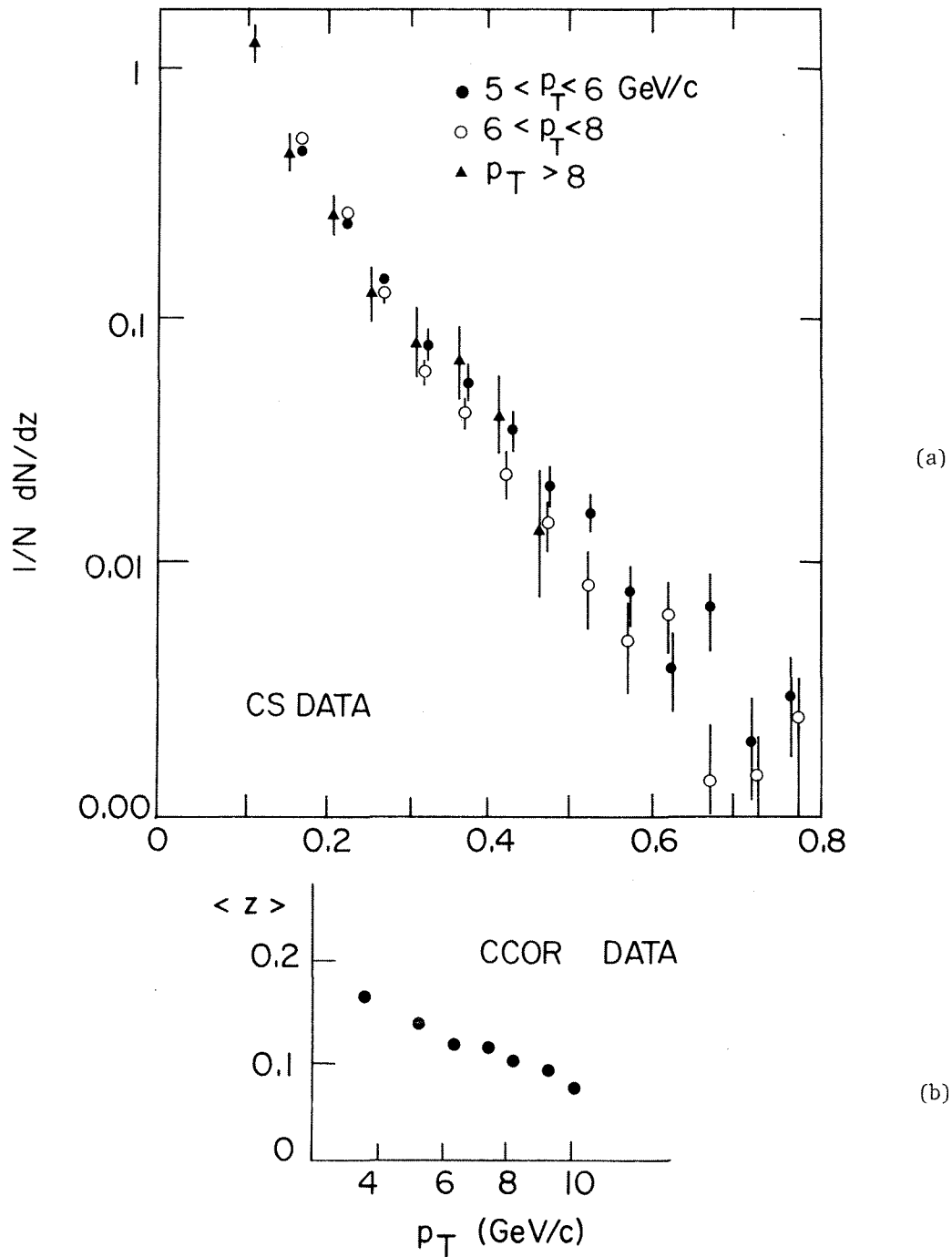

Figure 4.a) : Longitudinal distribution of charged particles associated with a high- $p_t$  neutral trigger. The longitudinal momenta are scaled according to the trigger momenta. Scaling applies to the fragmentation of the trigger jet. Data from the CERN-Saclay Collaboration.

4.b) : Mean value of  $\langle z \rangle$  as a function of the trigger momentum, as measured by the CERN-Columbia-Oxford-Rockefeller Collaboration. It should be constant for a scaling distribution!

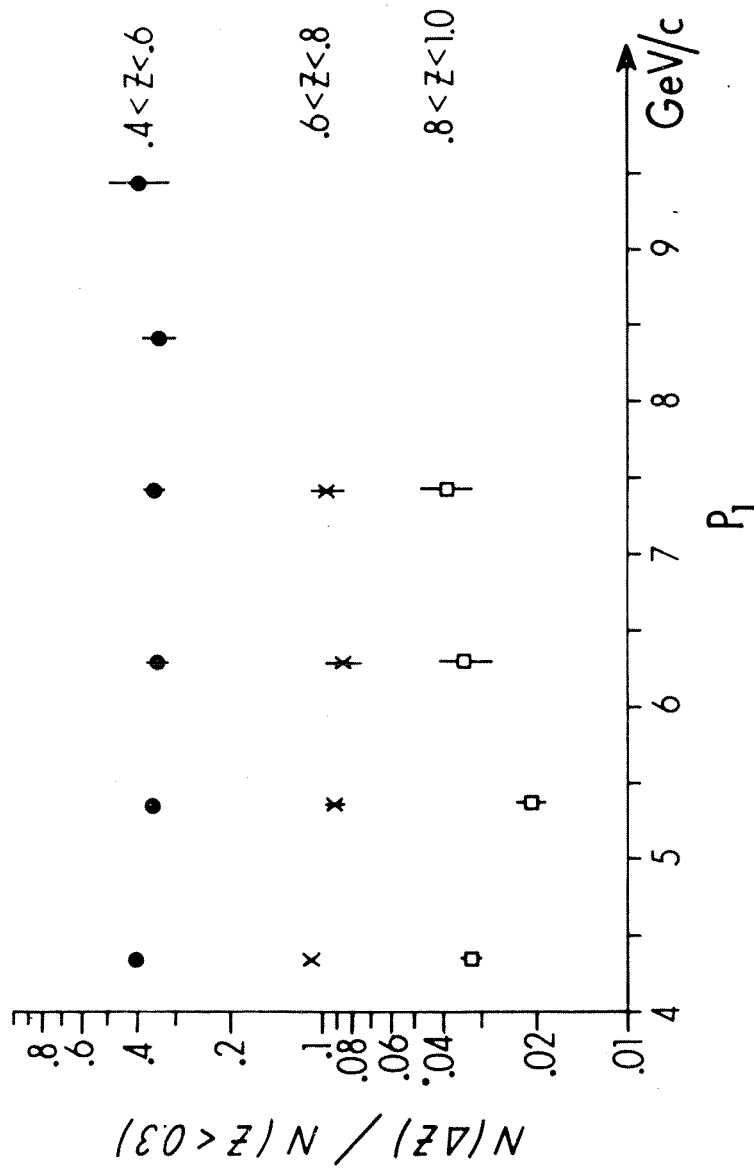

Figure 5.a) : Scaling on the away side. Data from the Athens-Brookhaven-CERN-Syracuse Collaboration. The yield for fixed values of  $x_e$  does not vary as  $p_t$  varies. The data are normalized to the yield at  $x_e < 0.3$ .

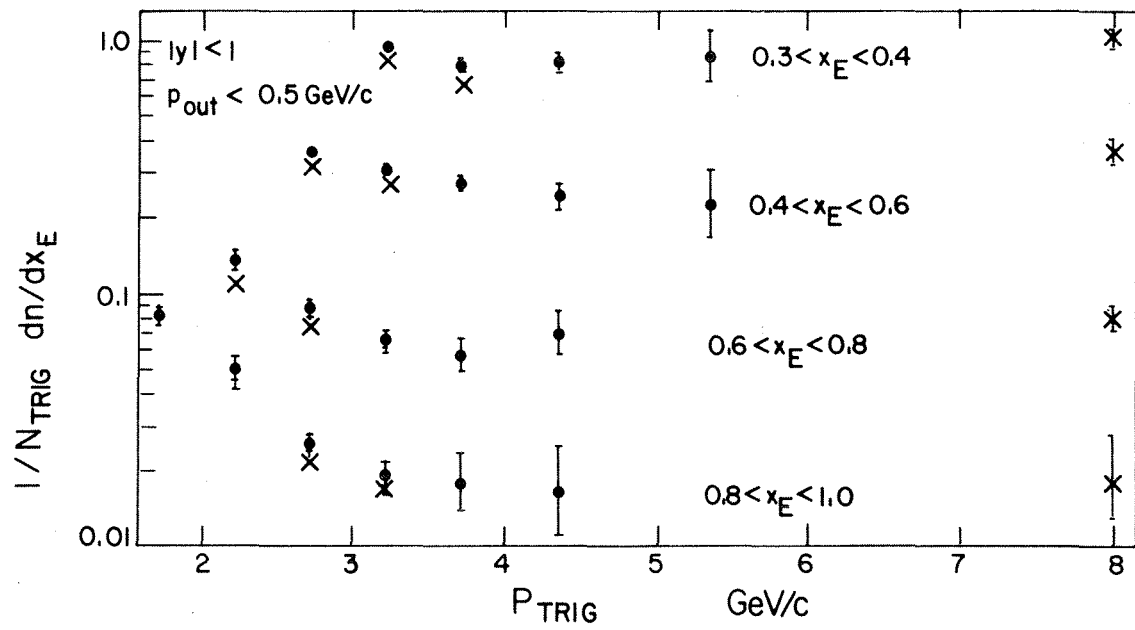

Figure 5.b) : Scaling on the away side. Data at lower  $p_t$ , Ref. 4, together with recent results from the CERN-Columbia-Oxford-Rockefeller Collaboration.

ling imposes itself as the trigger momentum becomes large enough and as the ratio between the trigger and away jet transverse momenta tends towards one.

An important consequence of scaling, and general ideas about jet fragmentation, is that the jet yield, collecting all particles associated with a jet, should be much larger than the single particle yield at the same  $p_t$ , usually considered when studying high- $p_t$  processes. Considering again our simplified model in order to illustrate the point, the single-particle cross-section is readily related to the jet cross-section at the same  $p_t$  as follows:

$$\frac{d\sigma}{dp_t} = \frac{d\sigma^j}{dp_t} \int_0^1 x^{n-1} F(x) dx \quad (3)$$

Since  $n$  is large ( $n \sim 10$ ) and  $F(x)$  falls as  $x$  increases, the weighting factor provided by the integral is small, hence the large ratio between jet and single-particle yields. The detailed comparison between jet cross-sections and single-particle cross-sections is far more involved experimentally<sup>20)</sup> and theoretically<sup>21)</sup>. The response of the jet (calorimeter) detector has to be analyzed in terms of a Monte Carlo simulation, which cannot avoid some preconceived ideas about jets. Figure 6 shows the recent outcome<sup>22)</sup> of E 260 at Fermilab (Caltech-UCLA-Fermilab-Illinois Collaboration). It gives the inclusive jet cross-section at  $90^\circ$ , together with the charged pion production cross-section measured at the same energy<sup>23)</sup>: 200 GeV. The jet cross-section is typically two orders of magnitude above the single-particle cross-section, the ratio increasing with  $x_t$  ( $x_t = \frac{2p_t}{\sqrt{s}}$ ) as expected<sup>21)</sup>.

Also shown in Fig. 6 are the results of a QCD calculation, the upper and lower curves corresponding to the production of a jet of given energy and momentum, respectively<sup>22)</sup>. Which one should be preferred is unclear. This is ambiguous in perturbative QCD. For the values of  $p_t$  here considered jet pionization dissipates about 1 GeV in transverse momenta and masses. This corresponds to a difference in yield by an order of magnitude. The British-French-Scandinavian Collaboration has recently measured the inclusive jet cross-section at 2.6 GeV jet energy from an unbiased data sample<sup>9)</sup>. It is found to be 150 times the single particle yield. The cross-section for a jet of 2.6 GeV momentum is lower by an order of magnitude. The jet to single particle ratio is also found to increase with  $x_t$ .

A large enhancement of the cross-section when considering a multi-particle system as opposed to a single-particle system at large  $p_t$  has also recently been reported from the analysis of  $K^-p$  interaction in BEBC at 110 GeV/c<sup>24)</sup>.

Figure 7.a) comes back on an effect which has been known for some time and which is of great relevance to the hard-scattering approach. It shows that pions are more efficient than protons at producing high- $p_t$  jets (and high- $p_t$  particles) and this the more so the larger  $x_t$  is. This is directly related to the fact that pion constituents carry a larger fraction of the particle momentum than proton constituents do.

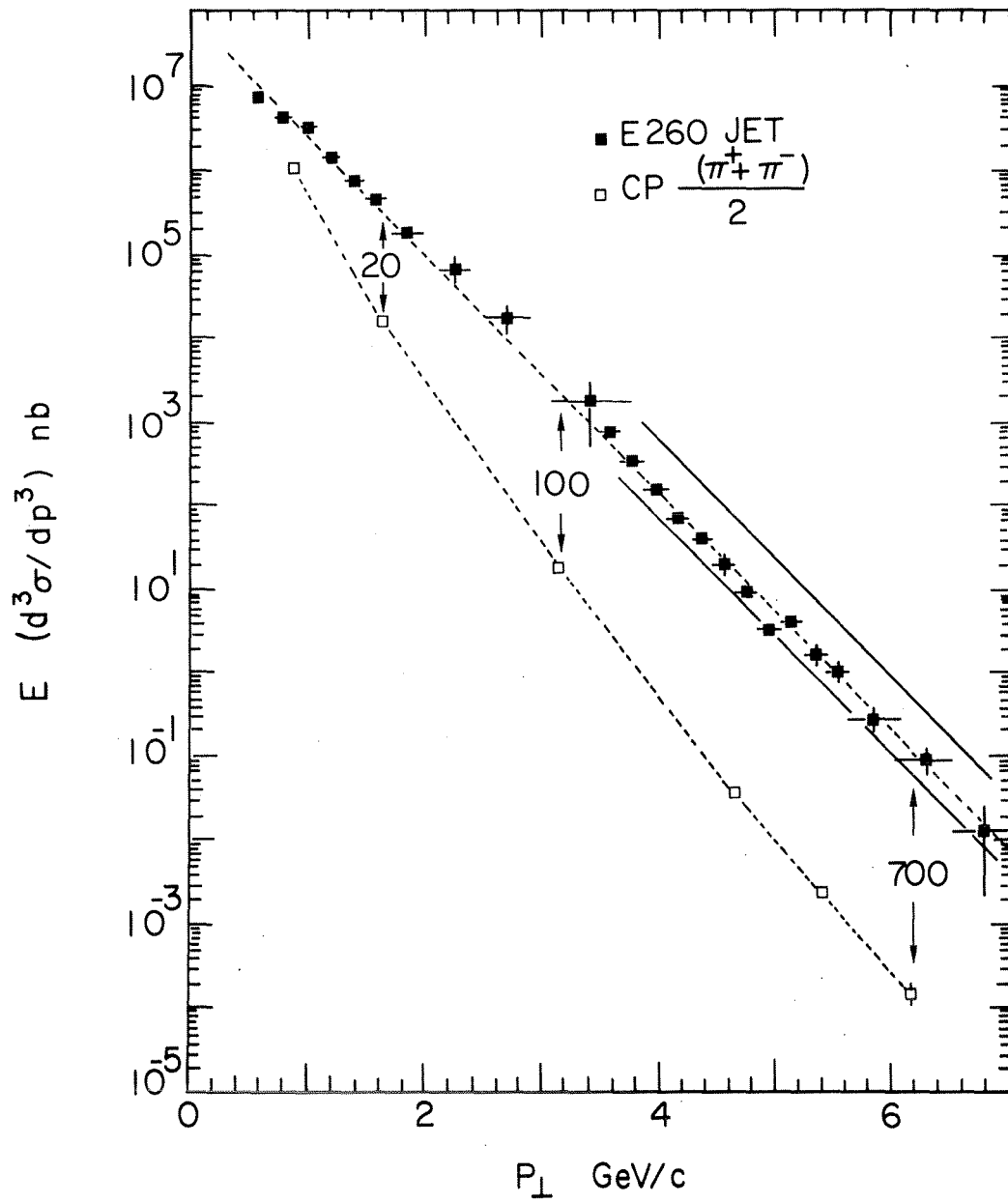

Figure 6 : Inclusive distribution for jets and for single particles. The jet data are from the Caltech-UCLA-Fermilab-Illinois Collaboration. The QCD calculation for jet production at fixed jet energy and fixed jet momentum brackets the data : G. Fox, private communication.



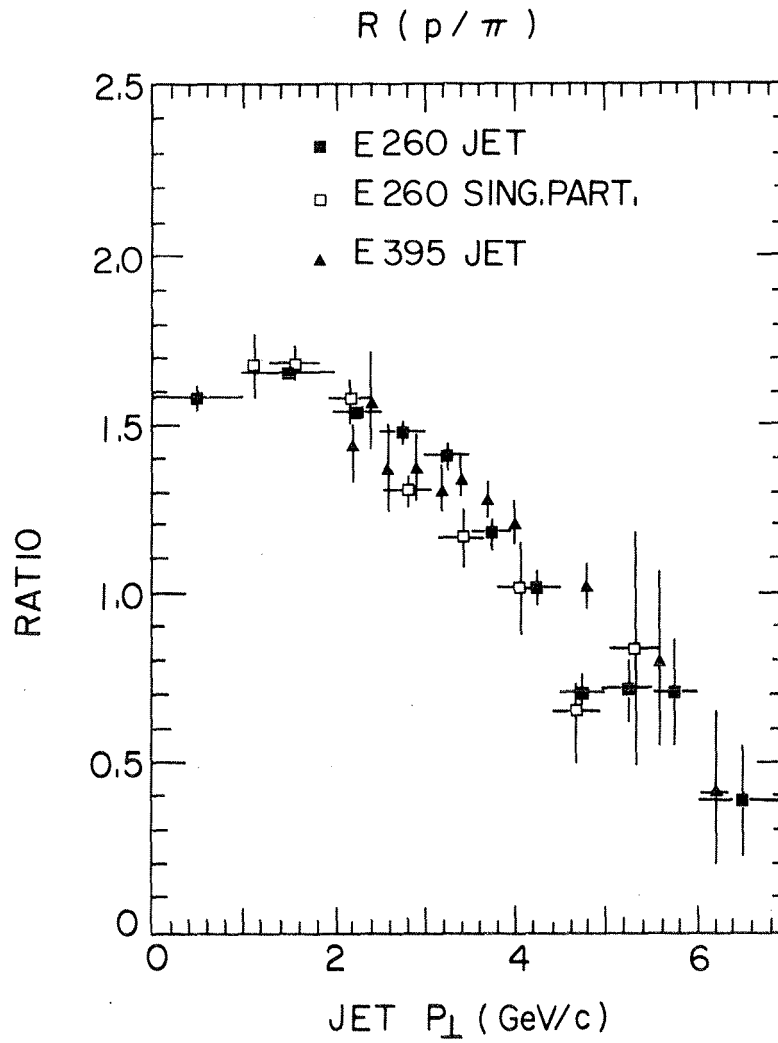

Figure 7.a) : The relative efficiency of proton and pion induced reactions. Ratio between the inclusive jet yield at  $90^{\circ}$  in proton- and pion-induced reactions. As  $p_{\perp}$  increases pions become more efficient. Data from E 260, Ref. 22.

A new feature, reported by Experiment 395 at Fermilab (Fermilab-Lehigh-Pennsylvania-Wisconsin Collaboration), is that the greater efficiency of pions actually refers to the production of jets emitted relatively forward, as again expected from pion constituents which take a larger fraction of the hadron they belong to<sup>25</sup>). Also shown (on Fig. 7.b)) are data obtained with a double arm calorimeter, setting one arm at  $90^\circ$  (as is the case for the inclusive jet yields, the ratio of which appears in Fig. 7.a)) and also at other angles and varying the direction of the other arm. As the production angle decreases, the relative efficiency of the pion beam increases.

A new result from the E 260 experiment is that the ratio between kaon and pion-induced reactions is compatible with one<sup>22</sup>). This holds from 1 to 5 GeV/c, and is shown in Fig. 8. More accurate data, extending over a wider  $p_t$  range would however be needed before one can conclude at similar distribution for strange constituent quarks. Antiprotons are also found to be slightly more efficient than protons at producing high- $p_t$  jets (by 10% up to  $p_t \approx 4$  GeV/c)<sup>22</sup>).

The same reasoning which leads to a large ratio between the jet-production cross-section and the single-particle cross-section also implies that when triggering on a large- $p_t$  particle one strongly favours infrequent fragmentation modes (or reaction processes), whereby most of the jet momentum is taken by a single particle<sup>18,26</sup>). One therefore expects that the accompanying momentum on the trigger side should increase with  $p_t$  in mean value while remaining relatively small (at the 10% level at most). This is shown to be the case by the British-French-Scandinavian results presented in Fig. 9<sup>27</sup>). The mean associated momentum for charged secondaries is shown as a function of the trigger momentum for different trigger particles. New is the relative rôle of the prominent resonances ( $\rho$ ,  $K^*$ ,  $\Delta$ , ...) in contributing to the associated momentum. It is rather large, amounting to 25 to 50% of the observed value<sup>28</sup>).

The complementary results displayed in Figs. 6 and 9 illustrate an important and general property of jet fragmentation. Whenever triggering on a high- $p_t$  particle one is likely to select a particular and unlikely configuration whereby most (or practically all) the jet momentum is with one single particle (Fig. 1.c)). The production cross-section is thus greatly reduced. Conversely, triggering on a whole jet, a much larger production cross-section is observed. Such an effect is usually referred to as trigger bias.

Now that jet fragmentation properties can be considered as well established, at least within a first and good approximation, it is possible to turn to results for which the analysis of the data implies even more preconceived ideas about jet properties and relies on comparisons involving the pertinent Monte Carlo simulations. A very important question now tackled is that of the transverse momentum balance which is achieved among the two wide-angle jets only and, first, that of the actual occurrence of an away-side jet in all events triggered upon by the observation of a high- $p_t$  particle. The

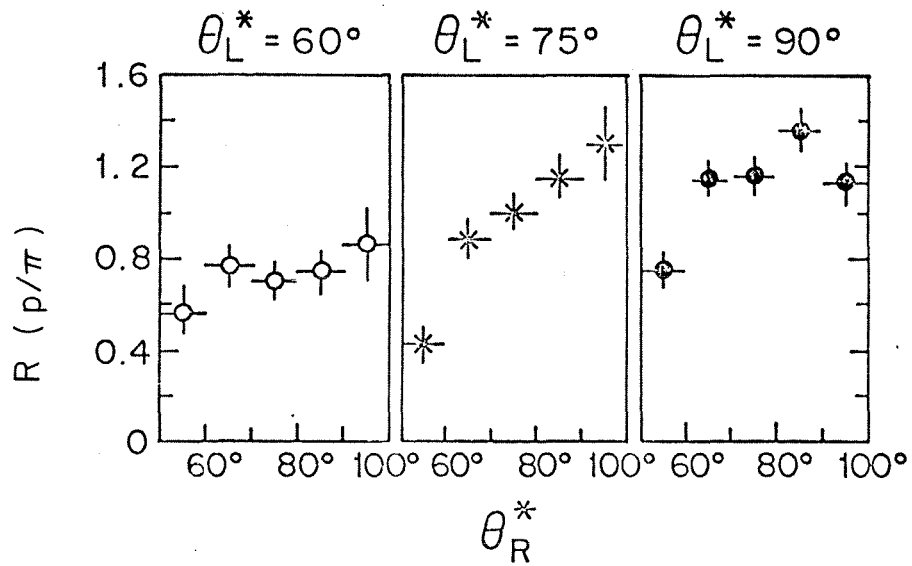

Figure 7.b) : Ratio between the double jet yield in proton- and pion-induced reactions. One calorimeter is set at  $60^\circ$ ,  $75^\circ$  and  $90^\circ$ , the other at a different production angle. The increased efficiency of the pion is associated with a prevailing forward production. Data from E 395, Ref. 25.

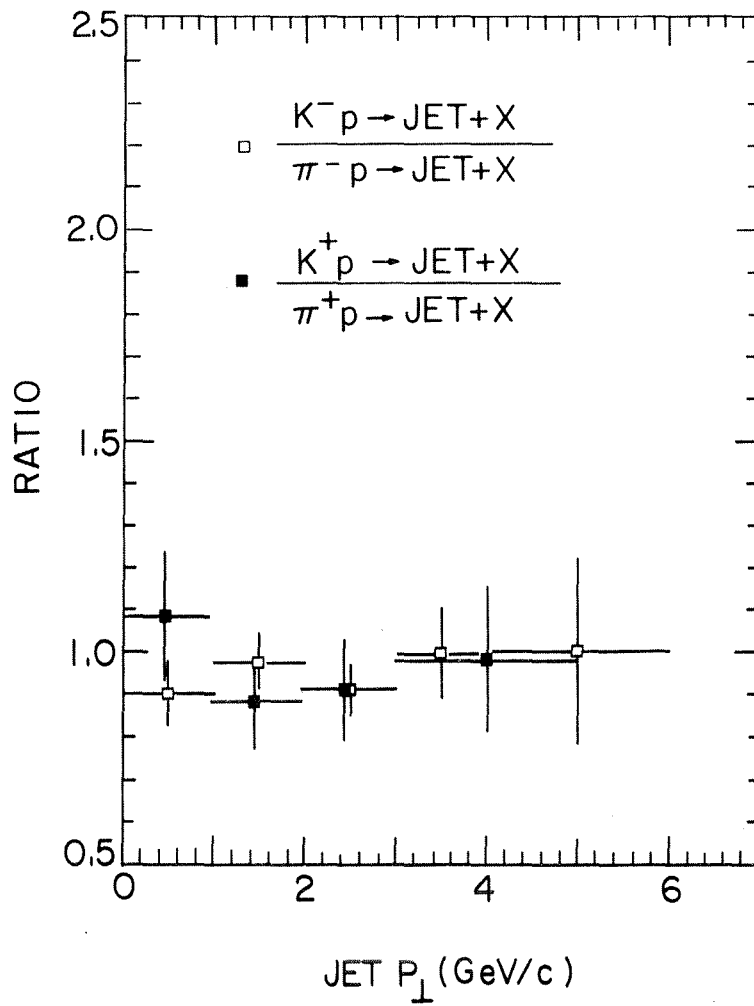

Figure 8 : The relative efficiency of kaon- and pion-induced reactions. Inclusive jet yields at 90°. Data from E 260, Ref. 22.

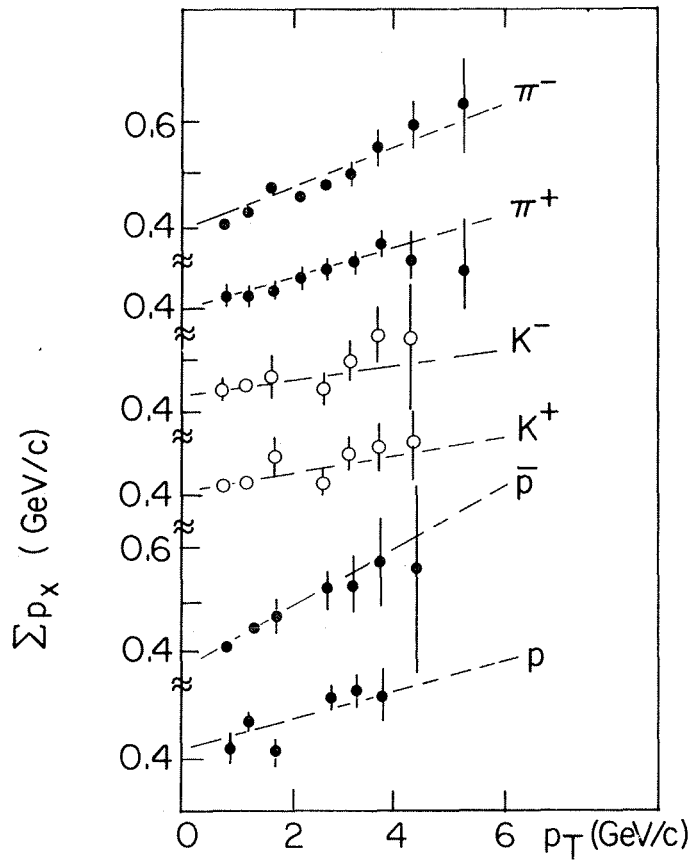

Figure 9 : The accompanying momentum to a high- $p_t$  trigger particle. Shown is the mean momentum carried by charged particles produced in the direction of the trigger. Data from the British-French-Scandinavian Collaboration, Ref. 26.

limited solid angle and biased acceptance of detectors have long hampered such investigations. Figure 10 shows the result of a recent analysis made by the British-French-Scandinavian Collaboration, using data obtained with the SFM detector at the ISR<sup>9)</sup>.

The probability of observing an away-side jet remains low, increasing only from 0.1 at 2 GeV/c to 0.4 at 5 GeV/c. Yet it is compatible with that expected if there was an away-side jet in each event, provided that it is assumed that the transverse momentum of the away-side jet does not quite balance that of the trigger jet. A discrepancy of the order of 0.8 GeV/c would do (Fig. 10). This discrepancy is compatible with previous results from the same group showing how fast forward and backward particles partly balance the transverse momentum of the trigger particle<sup>29)</sup>.

Such a good but yet partial balancing of transverse momentum between two jets also appears in the double arm calorimeter results of E 395<sup>24)</sup>. Figure 11.a) shows the momentum distribution observed in the away-side calorimeter (within two solid angles defined according to different fiducial limits) when triggering on a jet with a transfer momentum of 4 GeV/c. The distribution shows a peak which should be associated with a good collection of the away-side jet within the calorimeter. It is shifted to a lower  $p_t$  value. The  $p_t$  discrepancy observed in both cases should be in great part due to an obvious bias in favour of configurations with constituents moving in the direction of the triggering detector. This bias can however be overcome, triggering on both arms, requiring a particular value for the sum of the two transverse momenta. Figure 11.b) shows the  $p_t$  imbalance distribution observed when the sum of the two momenta should be between 4.5 and 5 GeV/c. The distribution peaks at zero with a full width at half maximum of 2.4 GeV/c. This imbalance distribution is in very good agreement with the value obtained by the CERN-Saclay Collaboration<sup>12)</sup>. Their method is less direct since the jet momenta have to be reconstructed from a two  $\pi^0$  trigger (in two opposite arms) and the associated charged particles. Yet it covers a much higher  $p_t$  range, the sum of the two jet momenta being between 8 and 12 GeV/c.

We may conclude at this stage that there is now evidence for a typical configuration with two jets with approximately opposite transverse momenta.

While other configurations cannot be excluded at this stage, available data are compatible with two wide angle jets balancing their transverse momenta to a rather good approximation.

With confidence in present jet parametrization thus building up, it is now possible to attempt to reconstruct the actual jet shape from the detected particles, unfolding biases imposed by the detectors, and to estimate with some precision ( $\sim 1$  GeV say) the centre-of-mass energy of the two-jet system<sup>30)</sup>. One is then in a position to compare jet fragmentation distributions and multiplicities (integrating over the inclusive fragmentation distribution) to those observed in  $e^+e^-$  annihilations and deep inelastic lepton scattering.

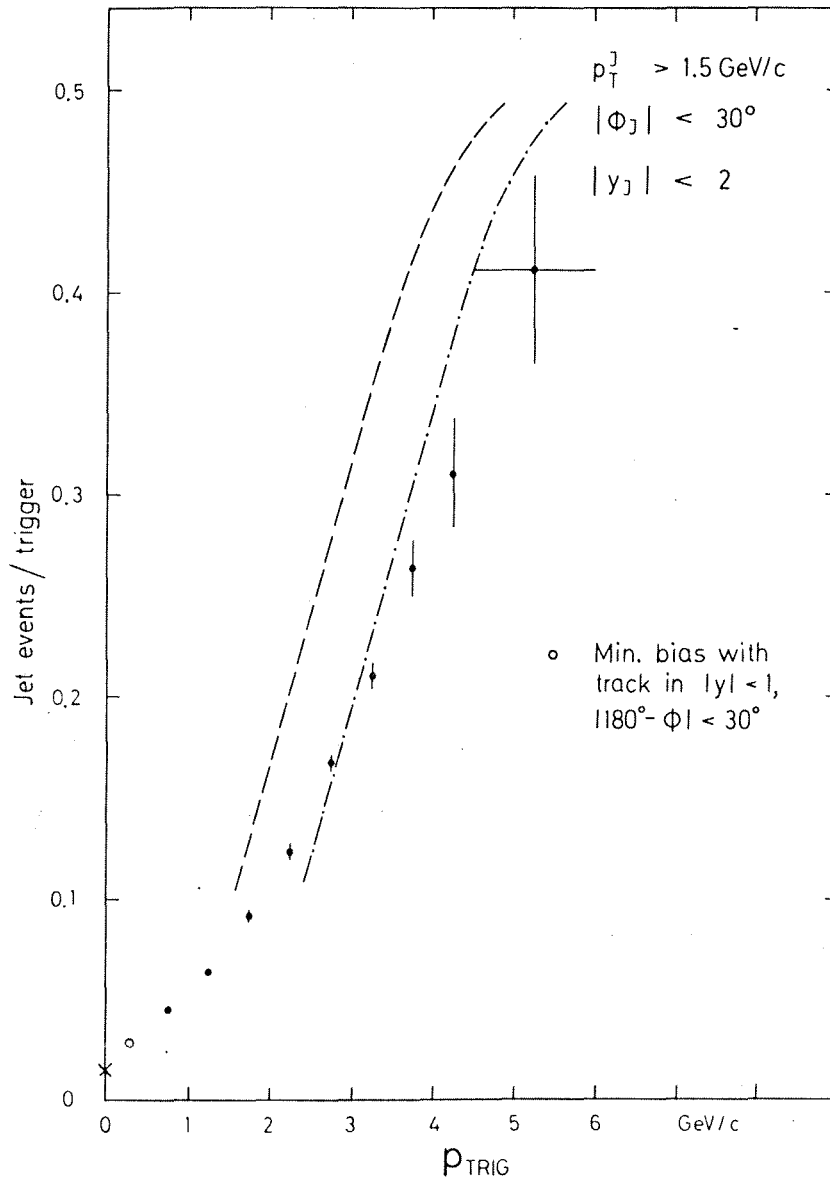

Figure 10 : Frequency of observing a jet on the away side. The low value corresponds to the limited solid angle of the detector. It is compatible with the occurrence of an away-side jet in each event with a high- $p_t$  particle provided that the jet is assumed to have a transverse momentum lower (by 0.8 GeV/c) than the trigger momentum. British-French-Scandinavian Collaboration, Ref. 9. Full balancing (dashed curve) and balancing up to 0.8 GeV/c (dashed-dotted curve).

### AWAY-SIDE $P_T$ SPECTRUM

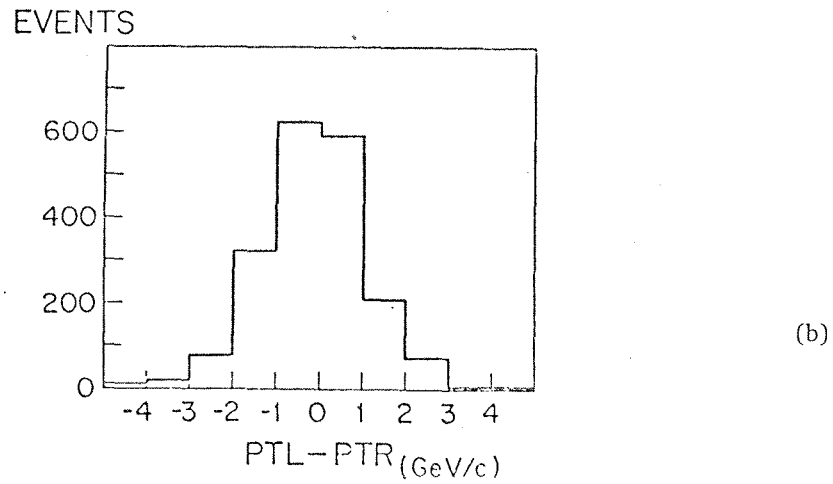
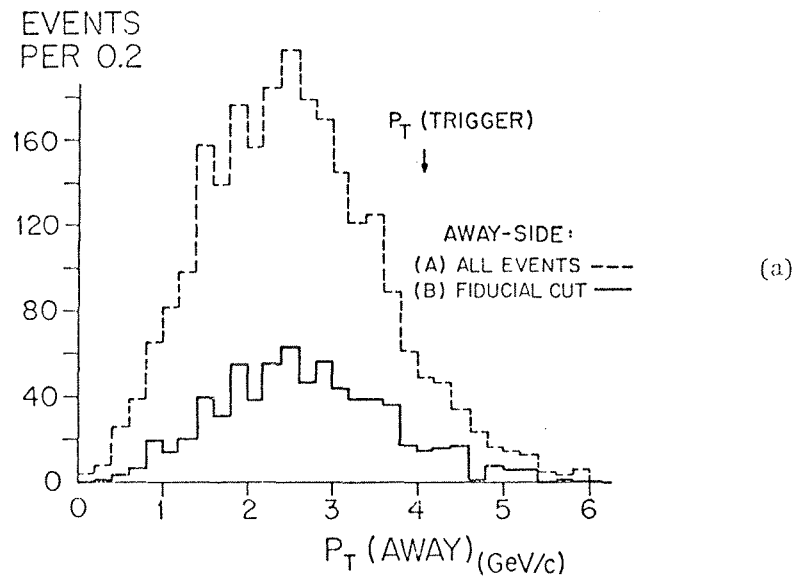

Figure 11.a) : Momentum collected in the away-side calorimeter when triggering on a jet with  $3.95 < p_t < 4.2$  GeV/c. A good fraction of the trigger momentum is found to be balanced within the limited solid angle covered by the calorimeter. Data from E 395, Ref. 24.

11.b) : Discrepancy between the two-jet momenta when triggering on two calorimeters. Ref. 24.



Such a comparison is illustrated by Fig. 12.a). The jet fragmentation distribution  $F(x)$ , reconstructed from the observed jet fragments, turns out to be amenable to an exponential parametrization in the range  $0.2 < x < 0.8$ . As does that observed in  $e^+e^-$  annihilation in the same energy range<sup>31)</sup>. The values of the slope parameter are in good agreement for both sets of jets. The ISR data are from the British-French-Scandinavian Collaboration<sup>9)</sup>.

Figure 12.b) gives results on the mean charged jet multiplicity, reconstructed for a two-jet system. The lower energy points are obtained by the British-French-Scandinavian Collaboration<sup>9)</sup>, the higher energy ones by the CERN-Saclay Collaboration<sup>12)</sup>. Also shown are results from  $e^+e^-$  annihilations<sup>31)</sup> and from the analysis of deep inelastic neutrino scattering<sup>15)</sup> at lower energies, and the PETRA data at higher energies which were reported at this Conference<sup>32)</sup>.

Again general agreement prevails. The British-French-Scandinavian Collaboration likes to emphasize the somewhat higher value of the multiplicity which they find as compared with the SPEAR values at the same energies<sup>9)</sup>. At present one may perhaps however rather stress the apparent similarity which appears, at least at this level of investigation, between jets observed in quite different processes. Even though it may not stand up to a more refined analysis, this similarity should remain as a first approximation. In the future one should be more ambitious and try to differentiate between quark and gluon jets. More extensive data, collected with more sophisticated detectors, are however needed.

### 3. THE HARD SCATTERING PROCESSES

Having discussed the jet structure and jet properties we now turn to the dynamics of high- $p_t$  production. In the hard-scattering approach, the inclusive distribution at angle  $\theta$  takes the well-known form<sup>1)</sup>:

$$E \frac{d\sigma}{d^3p} \sim \frac{1}{p_t^n} f(x_t, \theta) \quad (4)$$

where the value of  $n$  and the form of the scaling function  $f$  depend on the nature of the relevant constituents, the type of basic interaction at work and the nature of the observed particles.

For pion inclusive distributions at  $p_t < 6$  GeV/c, for which data have become precise and numerous, a very simple form holds with precision, namely (at  $90^\circ$ )

$$E \frac{d\sigma}{d^3p} \sim \frac{1}{p_t^n} (1-x_t)^m \quad (5)$$

with  $n = 8.6$ ,  $m = 10.6$  following a fit by the CERN-Columbia-Rockefeller-Saclay Collaboration<sup>19)</sup>. This is not the behaviour a priori expected from QCD perturbative interactions among quarks and gluons for which (for mere scaling reasons) one should find  $n = 4$ . At the same time estimates for the pion yield turn out to be too small when calculated in a straightforward way<sup>1)</sup>.

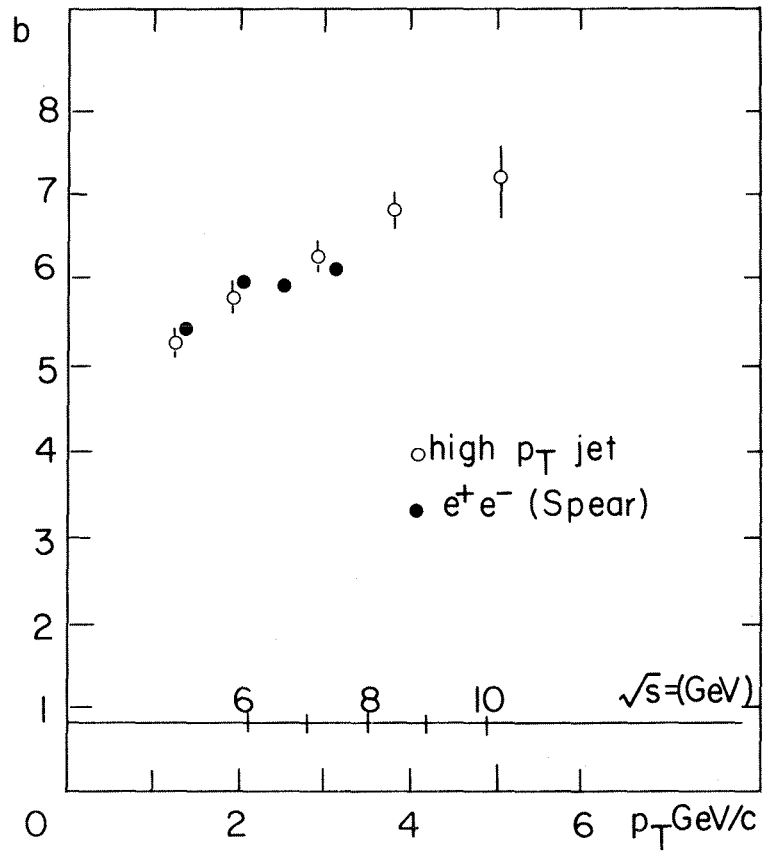

Figure 12.a) : Exponential fit to the jet fragmentation distribution for  $0.2 < z < 0.8$ . The slope is compared to that determined in  $e^+e^-$  annihilation and deep inelastic neutrino scattering. Data from the British-French-Scandinavian Collaboration, Ref. 9.

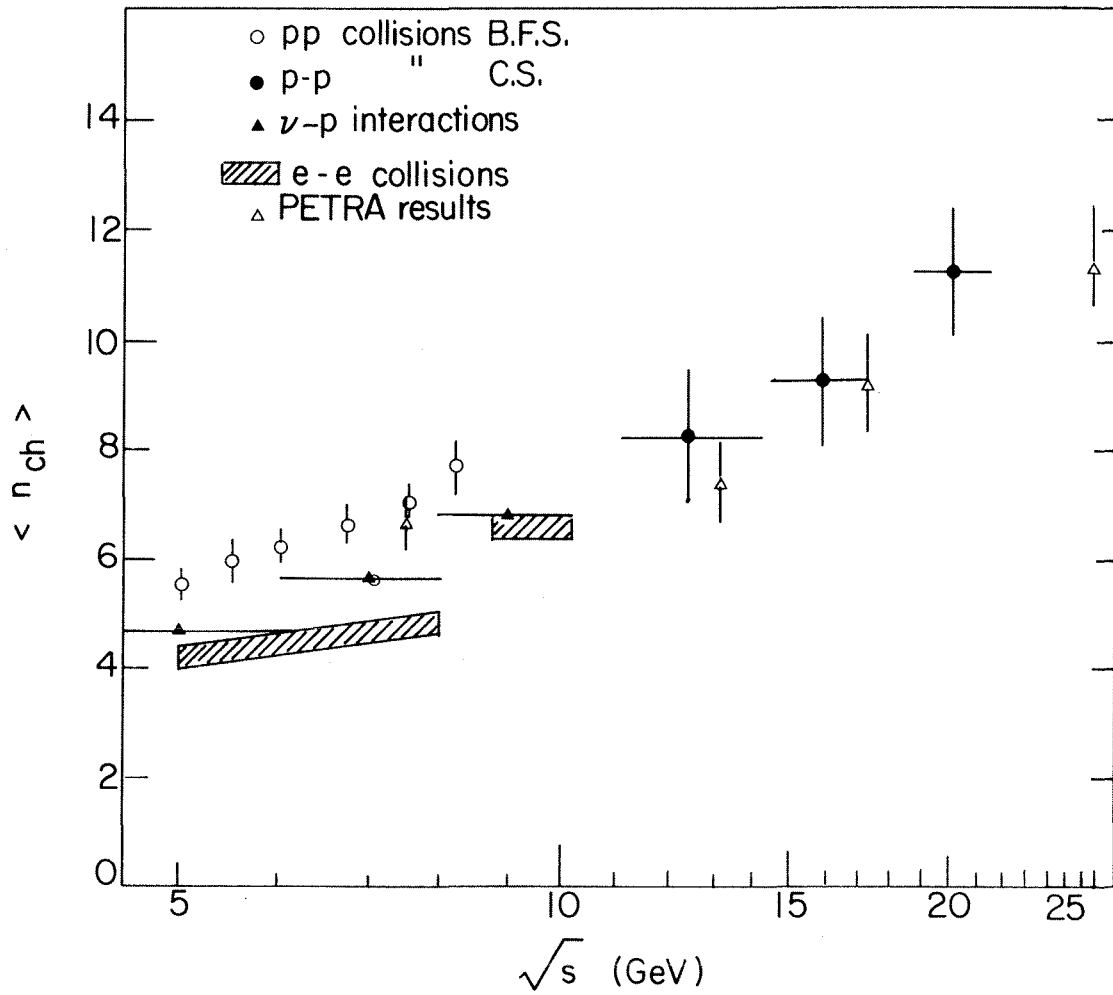

Figure 12.b) : Mean multiplicities as measured for high- $p_t$  jets,  $e^+e^-$  annihilation and deep inelastic neutrino scattering. Data from the British-French-Scandinavian Collaboration, Ref. 9 and CERN-Saclay Collaboration, Ref. 12.

The observed behaviour has thus supported for a while models where scattering involving non-elementary constituents would be dominant. A much-quoted example is the constituent interchange model (CIM) which indeed predicts the observed behaviour (5) with values for  $n$  and  $m$  (8 and 9 respectively) in quite good agreement with the fitted values. With confidence growing in the ultimate relevance of QCD, and the many difficulties encountered by CIM, or any other related model when considered as the dominant process, a certain flexibility has to be implemented in all approaches<sup>1)</sup>.

Before discussing that, we concentrate on recent results in very high  $p_t$  production ( $p_t > 10$  GeV/c) which provide a very strong hint at QCD sub-processes becoming the relevant ones. Figure 13.a) shows how the inclusive distribution of  $\pi^0$  departs from above from the extrapolation of the behaviour (5), so successful at  $p_t < 6$  GeV/c. The data cannot be reproduced with a single term of the form (5). They rather indicate the emergence of a new regime. Such a particular behaviour at very high  $p_t$  is obtained by three different collaborations with data on  $\pi^0$  production. While in Fig. 13.a) we present the CERN-Columbia-Oxford-Rockefeller results at 3 energies, Fig. 13.b) puts the  $\sqrt{s} = 62$  GeV results of the CERN-Columbia-Oxford-Rockefeller, Athens-Brookhaven-CERN-Syracuse, and CERN-Saclay-Zurich Collaborations on the same plot. I think that discrepancies are not relevant and will eventually disappear with a better understanding of the responses of the different detectors. The convergence of conclusions should be rather stressed. Using data at 52 and 62 GeV to separate the  $p_t$  and  $x_t$  dependence, the fitting parameter  $n$  which results (5) shows a clear change with  $x_t$ . According to CCOR,  $n \approx 8$  for  $x_t < 0.25$  and  $n \sim 5$  for  $x_t > 0.30$ . According to ABCS,  $n \approx 8$  for  $x_t < 0.25$  and  $n \sim 4$  to 5 for  $x_t > 0.25$ . Finally, CSZ, fitting (first) in the  $0.2 < x_t < 0.45$  range, obtain  $n = 6.6 \pm 0.8$ . There is a clear deviation between the highest  $p_t$  data and the well advertized  $n = 8$  behaviour of the lower  $p_t$  ones. A new regime sets in. It is compatible with expectation based on QCD. Indeed, it was almost common knowledge that, if the QCD sub-process had any relevance, the  $p_t^{-8}$  regime could not continue beyond 10 GeV/c.

At present there is a general consensus among theorists that QCD sub-processes do eventually become dominant, and that very high  $p_t$  production should be discussed in terms of quark and gluon scattering yielding quark and gluon jets. While such conclusions are still only tentative, they lead to anticipation of spectacular effects at collider energies ( $p\bar{p}$  interactions at  $\sqrt{s} = 540$  GeV). This point is worth being illustrated and Fig. 14 gives rates as now predicted<sup>33)</sup>. The expected effects are spectacular. Calculated rates depend however on the handling of scaling violations and on the choice made for quark and gluon distributions and fragmentation functions. Experimenting at collider energies one should be dealing with large effects which are very sensitive to still poorly controlled parametrizations which are of great importance in QCD calculations<sup>34)</sup>.

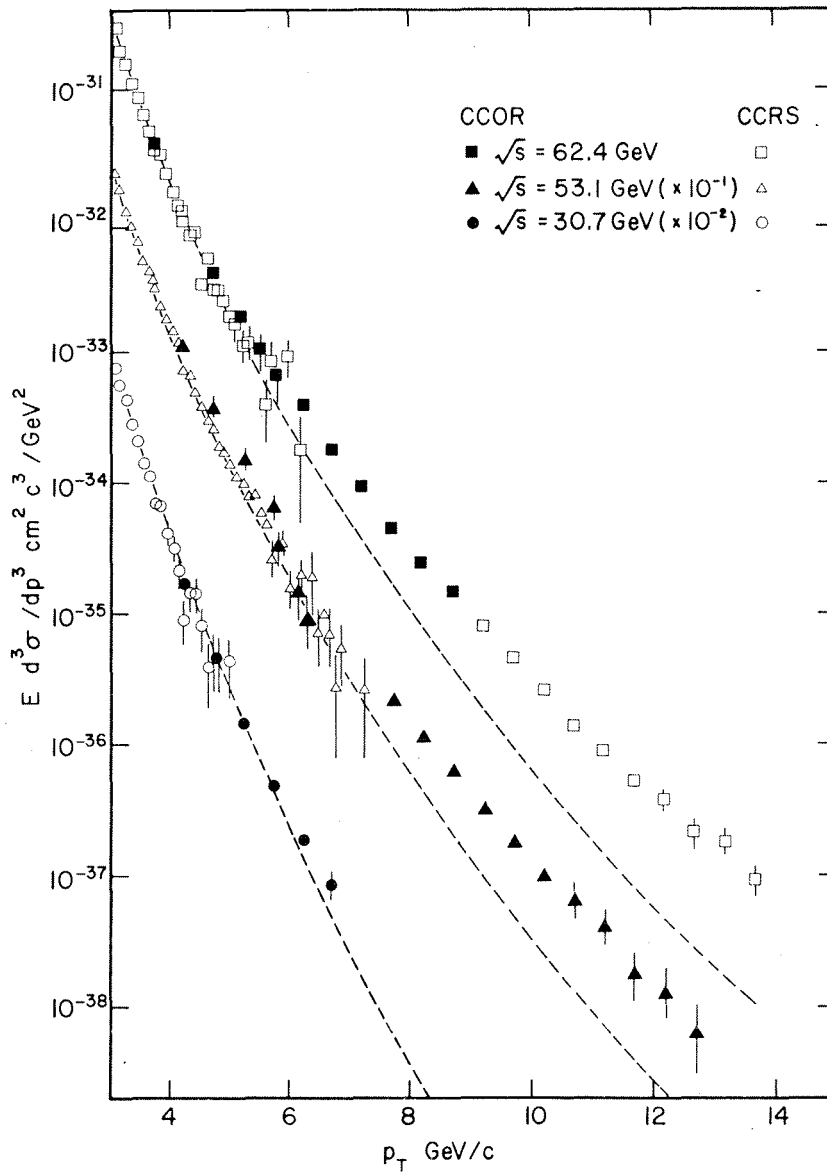

Figure 13.a) : Inclusive  $\pi^0$  yields at very large  $p_t$ . Inclusive yields at 3 different energies. The dashed curves correspond to a fit (relation 5) to the lower  $p_t$  results (CCRS).

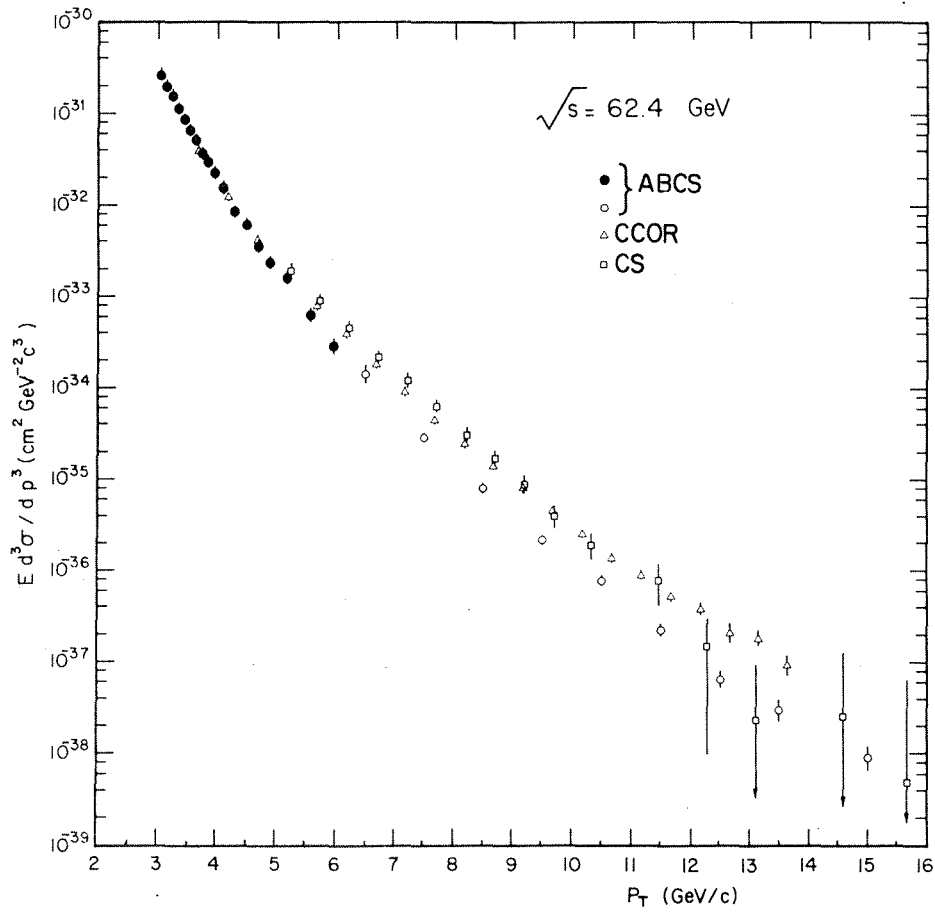

Figure 13.b) : Inclusive  $\pi^0$  yields at very large  $p_t$ . Inclusive yields at  $\sqrt{s} = 62 \text{ GeV}$  as reported by the CCOR, CS and ABCS Collaborations at the ISR.

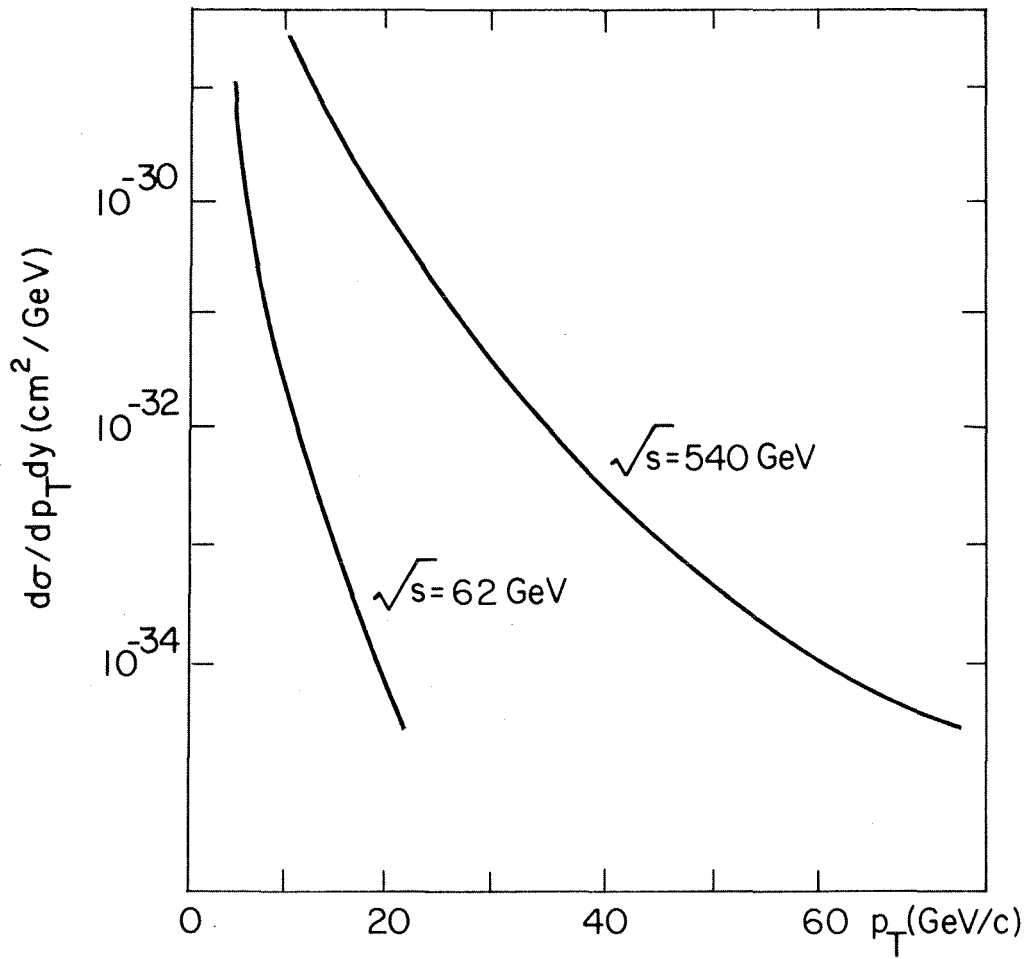

Figure 14 : Anticipated jet yields in  $p\bar{p}$  collisions at ISR,  $\sqrt{s} = 62 \text{ GeV}$ , and collider,  $\sqrt{s} = 540 \text{ GeV}$ , energies. Standard QCD calculation (leading log approximation) for  $p_T > 10 \text{ GeV}/c$  jet yields.

This review should however focus on the present situation, which is primarily concerned with data at  $p_t < 10$  GeV/c in the 200 - 2000 GeV range. As previously stressed the jet structure is now well established, but the nature of the relevant subprocesses is still under investigation.

Granting the fact that perturbative QCD determines rates at very high  $p_t$ , it should also be of some relevance at lower  $p_t$ . Nevertheless, an actual calculation has immediately to face important correction terms. Some of them have to do with scaling violation effects expected to be important at medium  $p_t$ . Constituent motion should further contribute to making the observed  $p_t$  dependence steeper as the result of an obvious bias which was already discussed and the relevance of which becomes relatively weaker as  $p_t$  increases. The analysis is also complicated by the relative rôle of quarks and gluons which change with  $p_t$  in a trigger-dependent way. While one has to acknowledge the fact that the overall picture becomes rather complicated and that parametrized corrections may dwarf perturbative contributions, a fair amount of success prevails. As discussed in detail by R. Field at the Tokyo Conference<sup>6)</sup>, calculations do lead to an acceptable agreement with data, the effective  $p_t$  dependence eventually obtained being much steeper than the input behaviour associated with basic QCD subprocesses<sup>35)</sup>. This does not exclude however that specific subprocesses of a more involved nature (higher twist effects in QCD) could be also relevant and contribute to producing effects which cannot be reached by QCD in its "leading log" implementation<sup>8)</sup>.

If one wishes to isolate best that contribution which belongs to perturbative QCD at moderate  $p_t$ , symmetric pair triggers offer an interesting handle, and this for two reasons. On the one hand, constituent motion effects are no longer emphasized by the triggering process as they are with single particle-triggers. On the other hand, an a priori competitive contender at medium  $p_t$  such as CIM is suppressed by the symmetry imposed on the trigger. Figure 15.a) shows symmetric pair data of the Chicago-Fermilab-Stony Brook Collaboration for  $\pi^+\pi^-$  production at 400 GeV<sup>36)</sup>, together with a QCD calculation performed by the Bielefeld Group<sup>37)</sup>. The main corrections correspond to scaling violations. Agreement prevails. However, in view of all the parametrization which has to be made with constituent distributions and fragmentation functions, it is important to check such a success over as wide an energy range as possible. It is therefore gratifying to see that the predictions made for symmetric  $\pi^0$  pairs at ISR energies are indeed in very good agreement with recent results from the CERN-Columbia-Oxford-Rockefeller Collaboration<sup>13)</sup> reported at this Conference. This is shown in Fig. 15.b), and builds confidence in using QCD at medium  $p_t$  values, even if important scaling violations have to be acknowledged.

Also shown in Fig. 15.a) are the respective contributions of the different subprocesses<sup>35)</sup>. This illustrates in particular the overwhelming rôle of gluons for  $x_t < 0.2$  and the relatively small rôle of pair formation, which is a particularly interesting process for the production of new flavours.



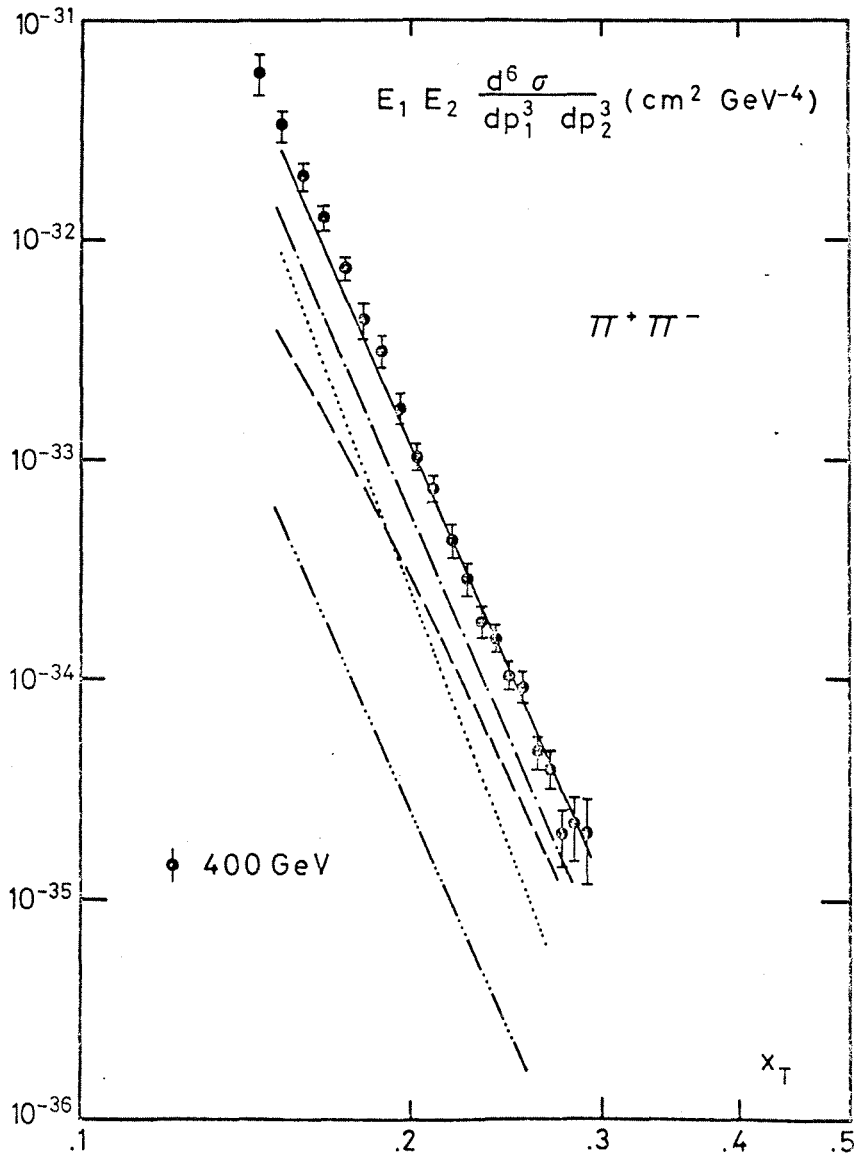

Figure 15.a) : Contributions of the various QCD subprocesses to the symmetric pair cross-section at 400 GeV versus  $x_T$ :  $qg \rightarrow qg$  (-.-),  $gg \rightarrow gg$  (...),  $qq \rightarrow qq$  (---) and  $gg \rightarrow q\bar{q}$  (-....-). The sum corresponds to the solid line. Data from Ref. 35.

$$\int E_1 E_2 \frac{d^6 \sigma}{d^3 p_1 d^3 p_2} d(\psi_1 - \psi_2)$$

$$\sqrt{s} = 62$$

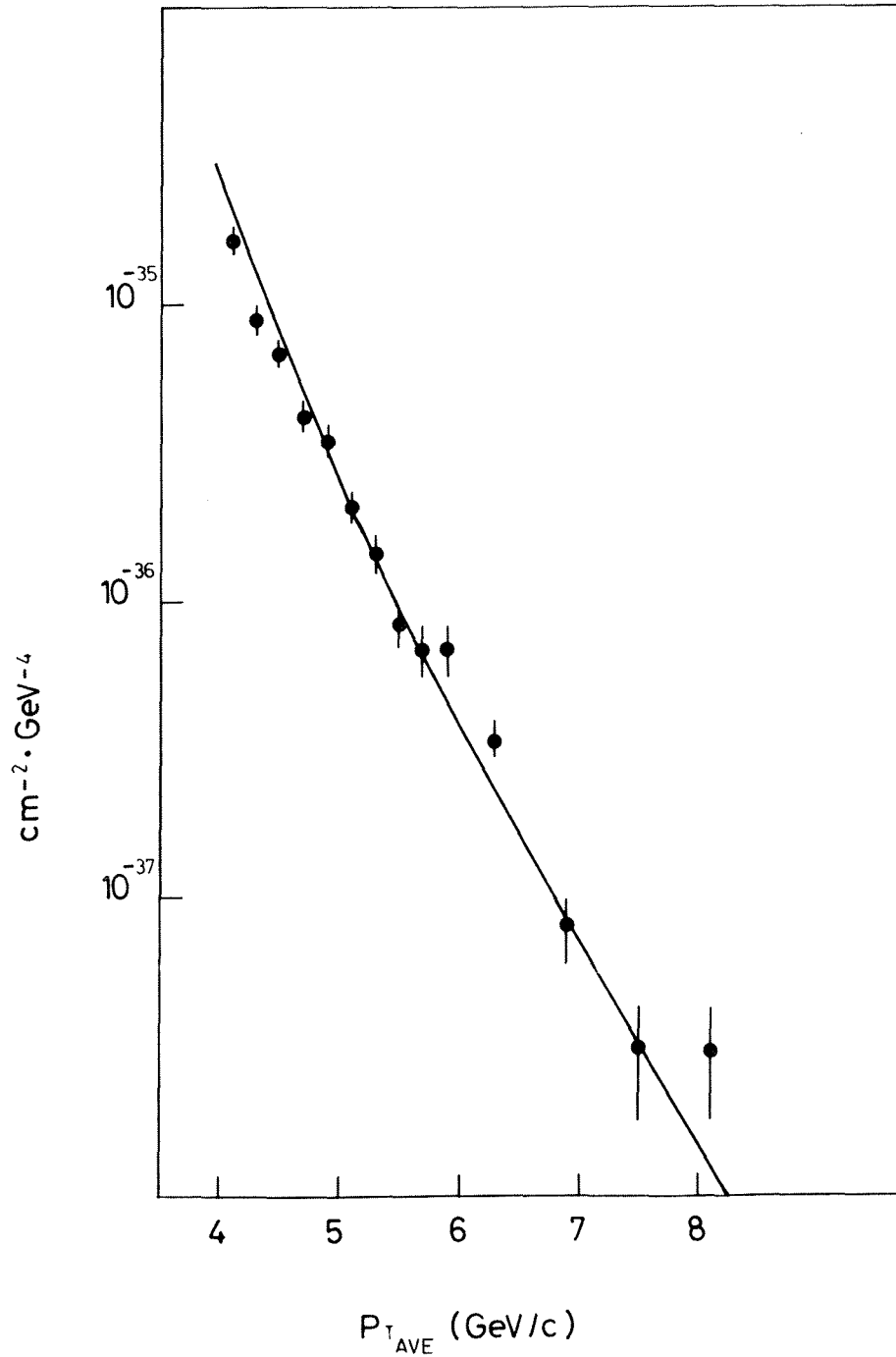

Figure 15.b) : Symmetric pair yield for  $\pi^0\pi^0$  at  $\sqrt{s} = 62$  GeV. Recent results from the CERN-Columbia-Oxford-Rockefeller Collaboration ( $\Delta p_T < 1$  GeV/c), preliminary data with a possible normalization error of 40% and predictions from Ref. 36.

It has often been emphasized that the comparison between pion- and proton-induced reactions should help to sort out the dominant mechanisms. While symmetric pair triggers suppress the CIM contribution, using an incident pion beam should enhance it. In connection with this, recent results from the Chicago-Princeton collaboration reported at the Conference<sup>38)</sup> (Fig. 16) show that the ratio  $R$  between the  $\pi^-$  and  $\pi^+$  yield is practically independent of  $p_t$ , whereas dominance of CIM, with the incident pion being globally scattered, would obviously impose a rising value of  $R$  with  $p_t$ . The observed behaviour is actually in good agreement with predictions based on the dominant rôle of QCD subprocesses, the difference between two calculations illustrating different parametrization of the pion structure function. These calculations give however too small a rate even though the ratio comes out right.

With such success, one could feel prompted to conclude that QCD, as used in its perturbative implementation, folding in all hadronization effects, meets experimental data in a satisfactory way<sup>21,39,40)</sup>. It should however now be stressed that there are many results which point at more involved processes. As emphasized by J. Owens<sup>40)</sup>, the observed inclusive proton yield is an order of magnitude above estimates based on QCD calculations, while its  $p_t^{-1.2}$  dependence is in good agreement with CIM dominance. Baryon production at medium  $p_t$  may thus reveal a particular type of subprocess. Quantum correlation data which, while modest, are definitely present also indicate the presence of contributions which do not enter perturbative QCD. The results of the British-Scandinavian Collaboration of a year ago, which indicated a dependence of the positive over negative excess observed on the away side, on the nature of the triggering particle<sup>5,6)</sup> are now complemented by more recent results from E 260 at Fermilab<sup>41)</sup>. Shown in Fig. 17 is the reconstructed away-jet charge for different trigger particles as recently determined by the British-French-Scandinavian Collaboration<sup>9)</sup>. The away-jet charge varies in a way as to partially compensate the charge of the trigger particle.

Such charge correlation effects among high- $p_t$  particles are valuable clues for the presence of processes for which QCD cannot provide a full account in its "leading log" form.

It should be stressed that the main charge correlations observed are found among members of the same jet and tend to a partial charge compensation within the jet. An extensive study of charge correlations has been made by the CERN-Collège de France-Heidelberg-Karlsruhe Collaboration<sup>42)</sup>, using medium  $p_t$  triggers. Recent results involving higher  $p_t$  triggers have been reported by the CERN-Saclay Collaboration<sup>12)</sup>. The amount of charge correlation among the two largest  $p_t$  charged particles is assessed through the value of a quantity  $r$ , which is defined as the ratio between the number of pairs with opposite charges to twice the square root of the number of pairs of positives times the number of negatives. Deviations from 1 thus measures the amount of correlations. Values of  $r = 1.52 \pm 0.05$ ,  $1.60 \pm 0.03$  and  $1.00 \pm 0.03$  are reported for particles within the trigger-side jet, the away-side jet and for leading charged fragments in the two opposite jets, respectively.

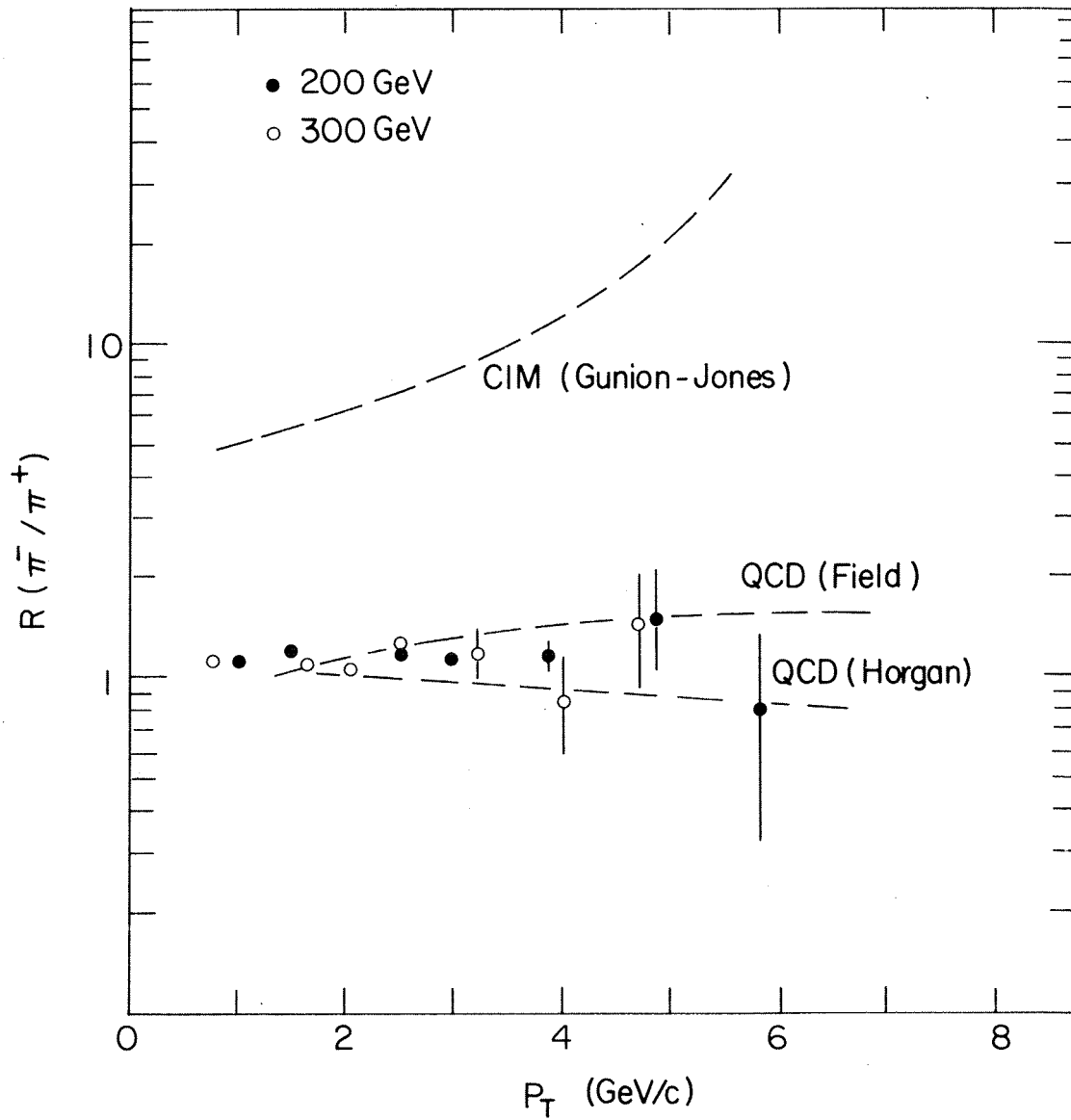

Figure 16 : Ratio of the  $\pi^-$  to  $\pi^+$  yield in  $\pi$ -p induced reactions. Data from the Chicato-Princeton Collaboration, Ref. 37.

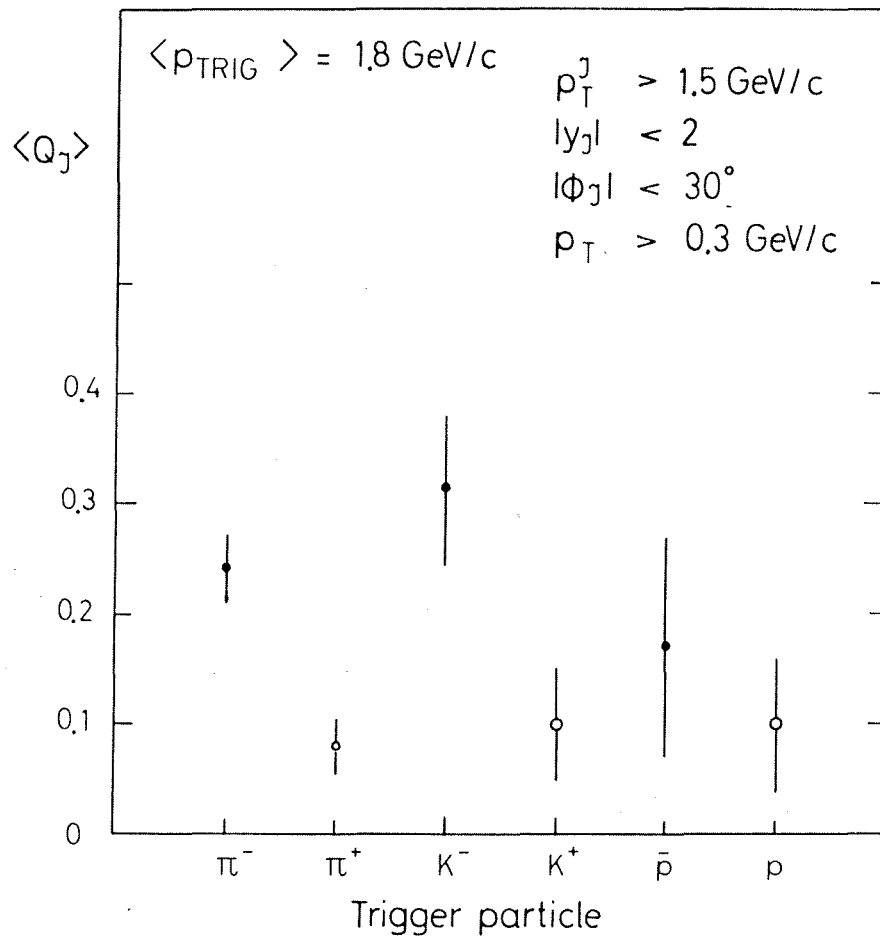

Figure 17 : Reconstructed jet charge on the away side. The mean charge varies with the kind of trigger particle used. Data from the British-Scandinavian Collaboration, Ref. 9.

Continuing data-sampling for special effects, it is considered appropriate to report a recent result by the Athens-Brookhaven-CERN-Syracuse Collaboration. This is shown in Fig. 18.a). The  $x_e$  distributions for  $\pi^0$  observed opposite to a high- $p_t$   $\pi^0$  show a systematic wiggle departure from an exponential fit (with a slope of the order of 7) which is well-determined by the data in the  $0.3 < x_e < 0.6$  range which both correspond to large  $p_t$  and high statistics<sup>43</sup>). The wiggle could bear witness to a specific process whereby the two jets would consist of one high- $p_t$   $\pi^0$  only (the so-called quark-fusion process). A probability for such a jet configuration at the 0.2% level would be enough to account for the observed effect, a value not incompatible with one of the  $\pi^0$ 's being a misidentified  $\gamma$  ray. The effect is also observed in the  $\eta\pi$  configuration and cannot be blamed on a photon- $\pi^0$  misidentification on both sides. The existence of the effect is however challenged by results from the CERN-Columbia-Oxford-Rockefeller Collaboration, also presented at this Conference, and shown in Fig. 18.b)<sup>13</sup>). In this case, an exponential fit is tailored over a larger  $x_e$  region and any attempt at a wiggle out of the exponential fit does not appear. One should then stress that the slope is definitely smaller ( $B \approx 5.3$ ) than the value used in Fig. 18.a) ( $B \approx 7$ ). Such a controversy should be resolved later. At present one may stress the common and a priori solid result of both experiments, namely the existence of some structure in the  $x_e$  distribution. If exponential fits are attempted, they have to be limited to a certain  $x_e$  range. A faster drop at lower  $x_e$  could be followed by a more gentle one at larger  $x_e$  but, as hinted at in Fig. 18.a), more structure could be present.

While we have thus singled out effects which point at something special (baryon production, charge correlation, structure in the  $x_e$  distribution) which are worth exploring in much greater detail, it remains that according to present knowledge, the QCD contribution, as calculated in a by now standard way with large scaling violations<sup>21,39</sup>), appears as a successful contender for typical configurations at medium  $p_t$  values, where most of our available data are. It is then worth looking beyond the standard jet picture for effects which one should also expect in this framework. We concluded that it is still premature to look for jet widening with reconstructed jets. A noticeable effect is however likely to appear rather easily in the acoplanarity of the two jets. The incident particle and the direction of the trigger particle define a scattering plane (Fig. 1.b)) which should contain the opposite-side jet. This it does to a good approximation (Fig. 2). While the standard parton approach would allow for but a limited transverse momentum with respect to that plane,  $p_{out}$  in the usual vernacular, QCD imposes an unbounded value, increasing with  $p_t$  though at the order  $\alpha_s$  only.

To the extent that the direction of the trigger-side jet is not precisely defined by the trigger particle and that one has to allow for some "primordial" transverse motion of the constituents, there should be some acoplanarity, usually parametrized by an exponential distribution in  $p_{out}$  and  $\langle p_{out} \rangle$

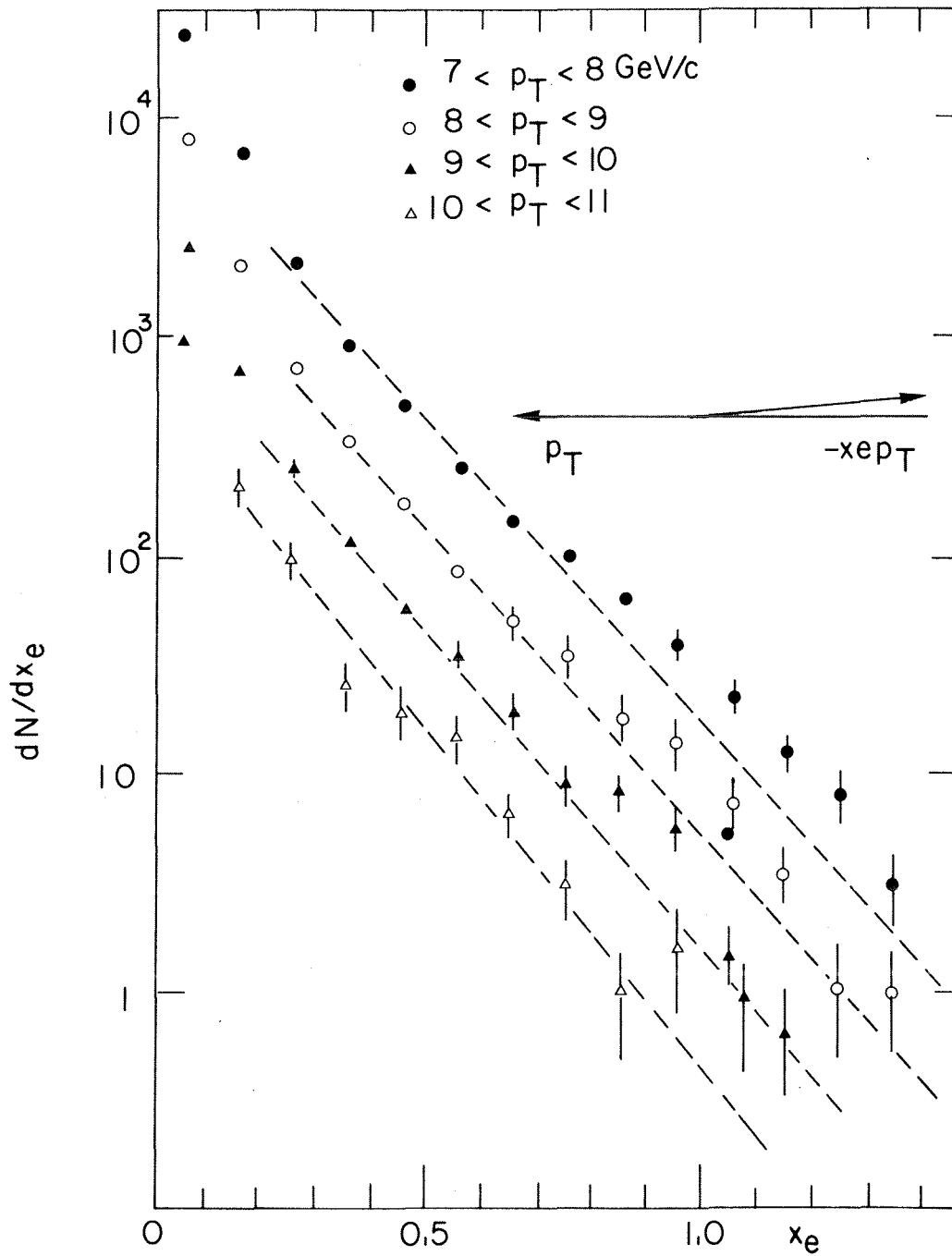

Figure 18.a) :  $x_e$  distribution for  $\pi^0$  with  $\pi^0$  trigger particle. Data from the Athens-CERN-Brookhaven-Syracuse Collaboration, Ref. 41.

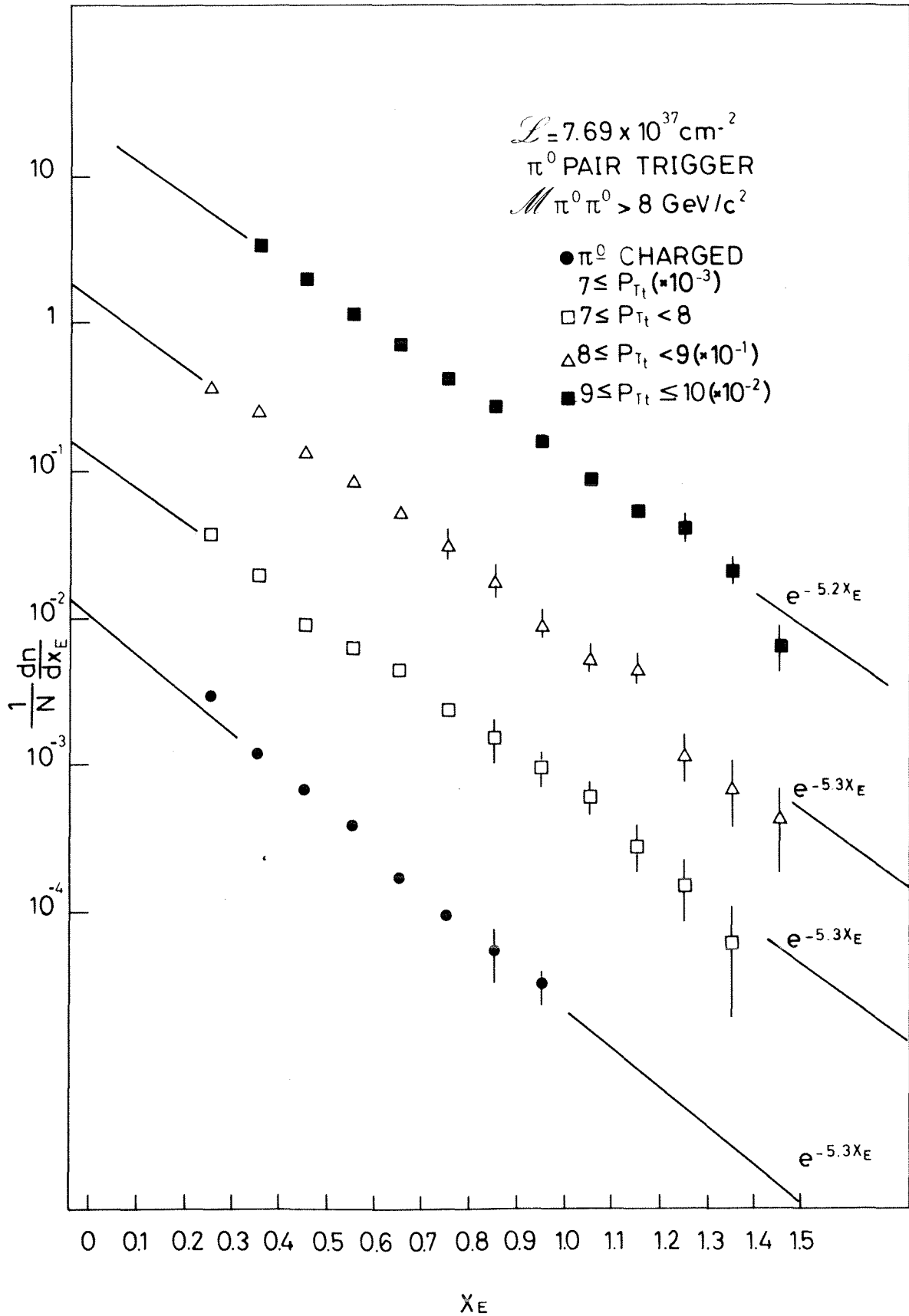

Figure 18.b) :  $x_e$  distribution for  $\pi^0$  with  $\pi^0$  trigger particle. Data from the CERN-Columbia-Oxford-Rockefeller Collaboration, Ref. 13.



should increase with  $x_e$ . Following perturbative QCD one should however expect  $\langle p_{\text{out}} \rangle$  to also increase with  $p_t$  at fixed  $x_e$ , as radiated gluons break the coplanarity structure. Figure 19.a) shows the values of  $\langle p_{\text{out}} \rangle$  recently reported by the CERN-Columbia-Oxford-Rockefeller Collaboration<sup>13)</sup>, for different trigger momentum values. They refer to the component out of the scattering plane for high- $p_t$  particles of the away-side jet. The increase with  $p_t$  is clear. It should be stressed that  $\langle p_{\text{out}} \rangle$  is not sufficient information insofar as one needs to search for a  $p_{\text{out}}^{-2}$  "tail", departing from an overall exponential distribution of  $d\sigma/dp_{\text{out}}^2$ , which is taken as parametrizing hadronization and primordial motion lumped together. Figure 19.b) gives the actual  $p_{\text{out}}$  distribution, as measured by the Athens-Brookhaven-CERN-Syracuse Collaboration for different  $x_e$  and  $p_t$  ranges. One clearly sees the widening of the distribution as  $x_e$  (and  $p_t$  at fixed  $x_e$ !) increases. Nevertheless, one cannot go beyond an overall exponential parametrization though with a decreasing slope as  $p_t$  increases. It is still impossible to point separately at calculable perturbative effects and parametrized non-perturbative ones. Yet a QCD calculation, facing all the intricacies of the  $2 \rightarrow 3$  processes, which has recently been carried out by a DESY Group<sup>44)</sup>, reaches a remarkable agreement with the data. One may at least say that looking at a particularly sensitive parameter,  $p_{\text{out}}$ , the observed behaviour, which definitely departs from the standard parton model predictions, is compatible with that expected in perturbative QCD.

#### 4. THE PROMPT PHOTON QUESTION

It is a common feature of all hard-scattering approaches that prompt photons should be seen at high  $p_t$  with a relative yield much larger than  $\alpha$ . Photons are natural hard constituents and, while their production may be damped down by  $\alpha$  as compared with that of hadrons, this comparison should refer to the production of a jet and not to that of a single meson. If one takes into account the relatively low yield of single particles as compared to a jet at high  $p_t$ , one readily concludes that there is a sizeable  $\gamma/\pi$  ratio.

In perturbative QCD, where quark-gluon scattering plays an important rôle, the subprocess  $gq \rightarrow \gamma q$  is the natural source of prompt photons<sup>45)</sup>. The  $\gamma/\pi$  ratio is controlled by the fragmentation of a jet into a leading  $\pi$ ; it increases with  $x_t$ . In the CIM approach prompt photons are eventually favoured over pions by a weaker  $p_t$  dependence<sup>46)</sup>. The  $\gamma/\pi$  ratio should increase with  $p_t$  as  $p_t^2$  to also become much larger than  $\alpha$  even though the trigger jet consists of only one meson by construction.

While the  $\gamma/\pi^0$  ratio has been an important theoretical issue for some time<sup>1)</sup>, the experimental situation was long uneasy<sup>19)</sup>. This stems from the fact that prompt photons have to be singled out among a huge  $\pi^0$  background, something which the often quantized nature of the detector (lead glass blocks) makes a formidable problem to tackle. At this Conference, results from the Athens-Brookhaven-CERN Collaboration have been presented as evidence for a

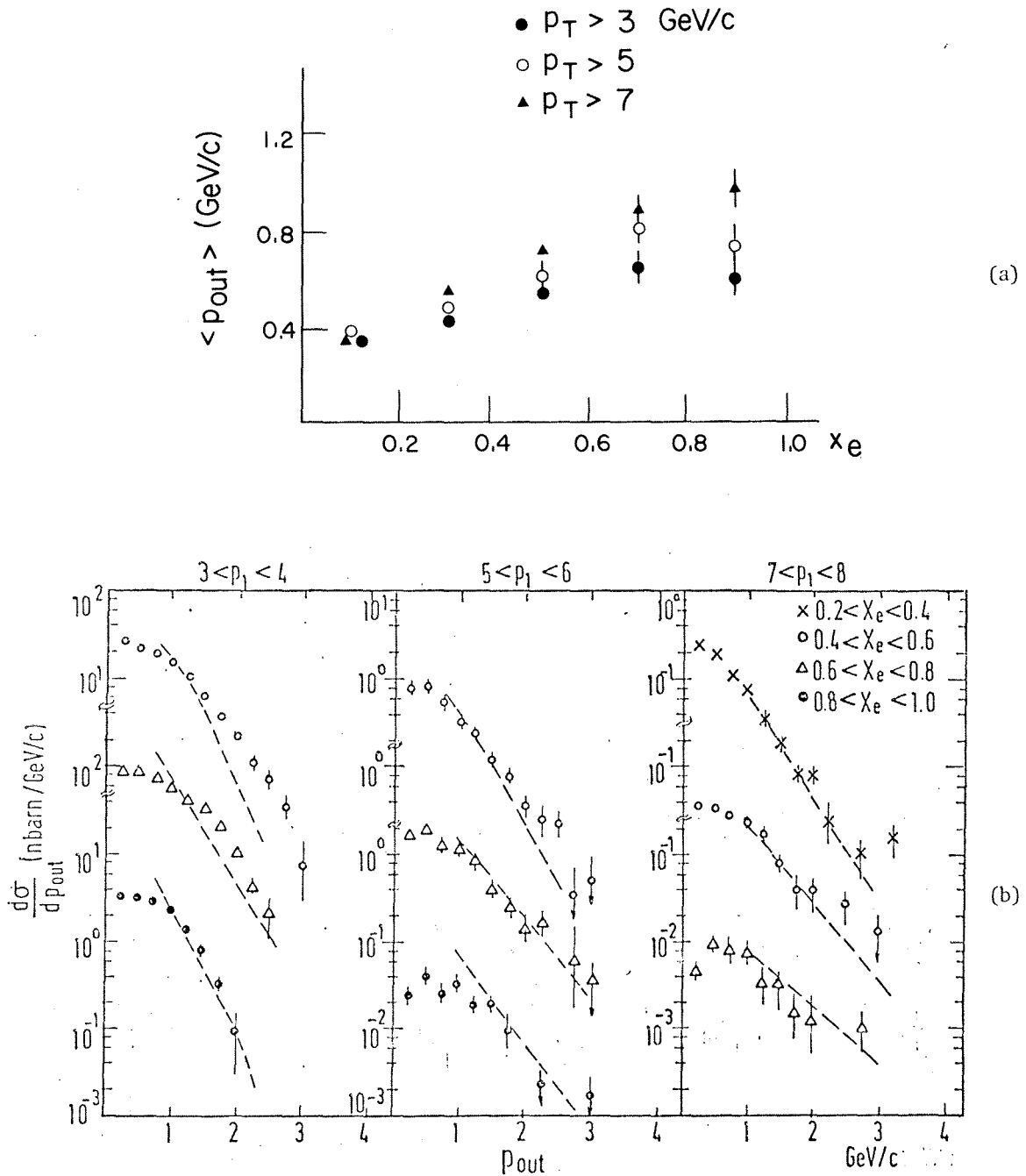

Figure 19.a) : The variation of  $\langle p_{out} \rangle$  with  $x_e$  for different trigger momenta. Data from the CERN-Columbia-Oxford-Rockefeller Collaboration, Ref. 13.

b) : The  $\langle p_{out} \rangle$ -distribution for different  $x_e$  ranges and different trigger momenta. Data from the Athens-Brookhaven-CERN-Syracuse Collaboration, Ref. 11. Also shown (dashed curves) are the results of a QCD calculation, following well the widening of the  $\langle p_{out} \rangle$  distribution with increasing  $p_T$ , Ref. 42.

$\gamma/\pi^0$  ratio at the 20% level at  $p_t \approx 6$  GeV/c<sup>47</sup>). The use of a liquid argon lead calorimeter is of great help in differentiating  $\pi^0$ 's and prompt photons. This is discussed in detail in the report by C. Fabjan<sup>48</sup>). The data are presented in Fig. 20.a). Also presented, in Fig. 20.b), are data obtained earlier by the Rome-Brookhaven-CERN-Adelphi Collaboration using a lead glass detector<sup>49</sup>). They are compatible with the newer and more precise data from the ABC Collaboration, which extend beyond 6 GeV/c. The observed ratios (Fig. 20.a)) can be considered to be in semi-quantitative agreement with calculations<sup>45,46</sup>). It is still premature to claim an  $x_t$  as opposed to a  $p_t$  dependence. This beautiful experimental result will certainly prompt further effort to extend the  $p_t$  range to higher values and, on the theorists side, for more involved calculations.

#### 5. ELASTIC SCATTERING AT WIDE ANGLES

From a theorist's point of view, the behaviour of elastic scattering at wide angle cannot be dissociated from the analysis of inelastic high- $p_t$  phenomena<sup>1</sup>). One expects a new regime to take over the overwhelming Regge contribution at small angle. The differential cross-section at fixed angle should eventually decrease with increasing energy as an inverse power only, namely:

$$\frac{d\sigma}{dt} \sim s^{-n} f(\theta) \quad (6)$$

The situation is a priori more complicated than when studying inclusive processes or jet production. Nevertheless, the same subprocesses should be at work. The smallness of the rates make such studies very difficult. At this Conference recent results on meson-proton scattering up to  $90^\circ$ , at 20 and 30 GeV/c incident momentum, have been reported by the CERN-Annecy-Genova-Copenhagen-Oslo-UC London Collaboration<sup>50</sup>). The agreement with dimensional counting rules is reasonable<sup>51</sup>). Figure 21.a) shows the  $\pi$ -p elastic scattering cross-section and the solid curves correspond to a CIM fit to the  $\pi$ +p data at 20 GeV/c. The fall of the cross-section at  $90^\circ$  which is followed over 4 orders of magnitude meets expectations. However, as shown in Fig. 21.b), agreement is only approximate. While these data contribute evidence for a new regime, which meets expectations based on hard scattering ideas, the question of elastic scattering at wide angle is only barely explored.

#### 6. CONCLUSION

Many new and important pieces of data have become available since the Tokyo Conference. We are now more knowledgeable about high- $p_t$  processes and, while perhaps not much wiser than a year ago, certainly far more confident in our understanding of the pertinent dynamics, insofar as previous assumptions have become fact. Expectations based on the parton model have met with great success. Quantum chromodynamics not only provides a promising framework but can now claim at least a semi-quantitative success<sup>52</sup>). High-

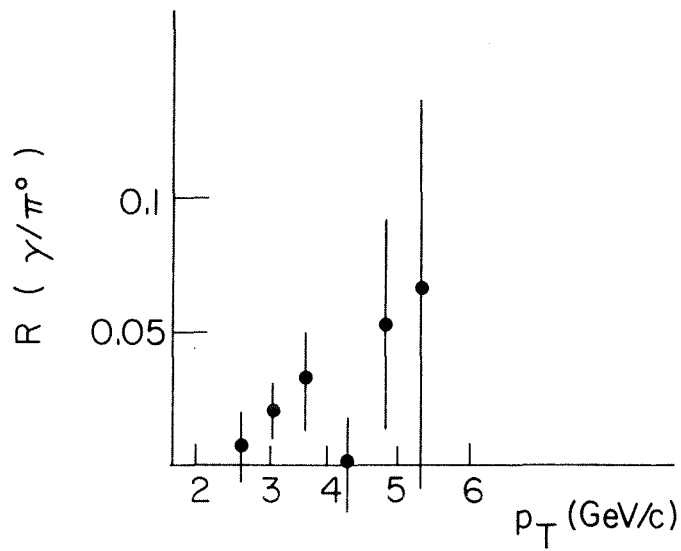
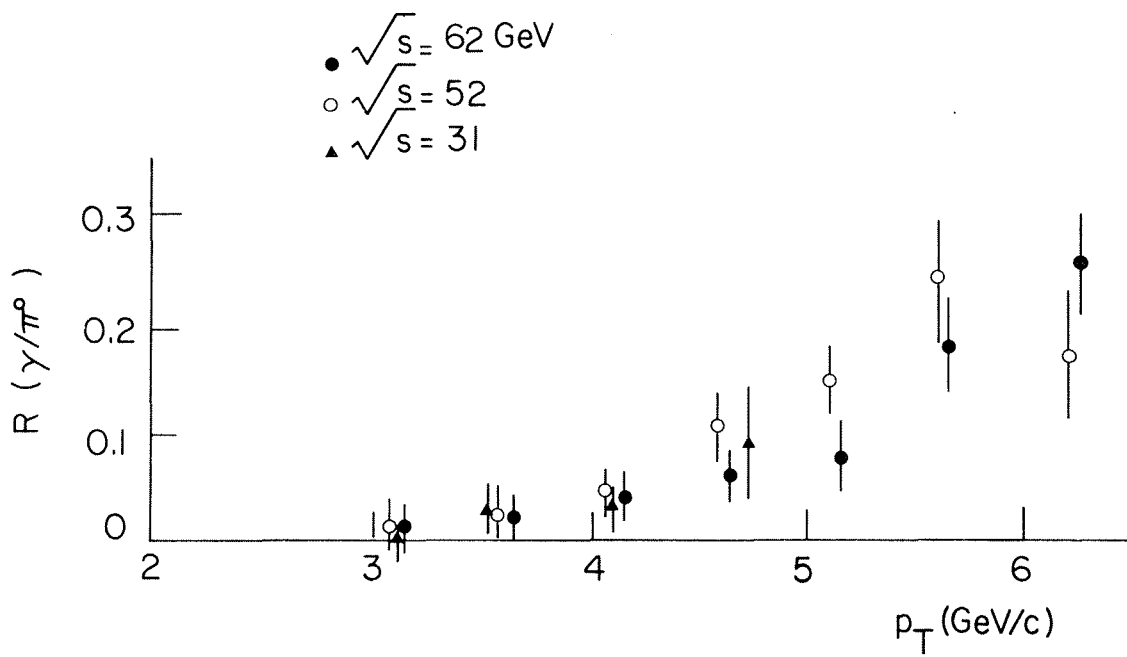

Figure 20.a) : The prompt photon yield. The  $\gamma/\pi^0$  ratio as a function of  $p_T$  at  $\sqrt{s} = 31, 52$  and  $62$  GeV. Data from the Athens-Brookhaven-CERN Collaboration, Refs. 45 and 46.

b) : The  $\gamma/\pi^0$  ratio as a function of  $p_T$  at  $\sqrt{s} = 52$  GeV. Data from the Rome-Brookhaven-CERN-Adelphi Collaboration, Ref. 47.

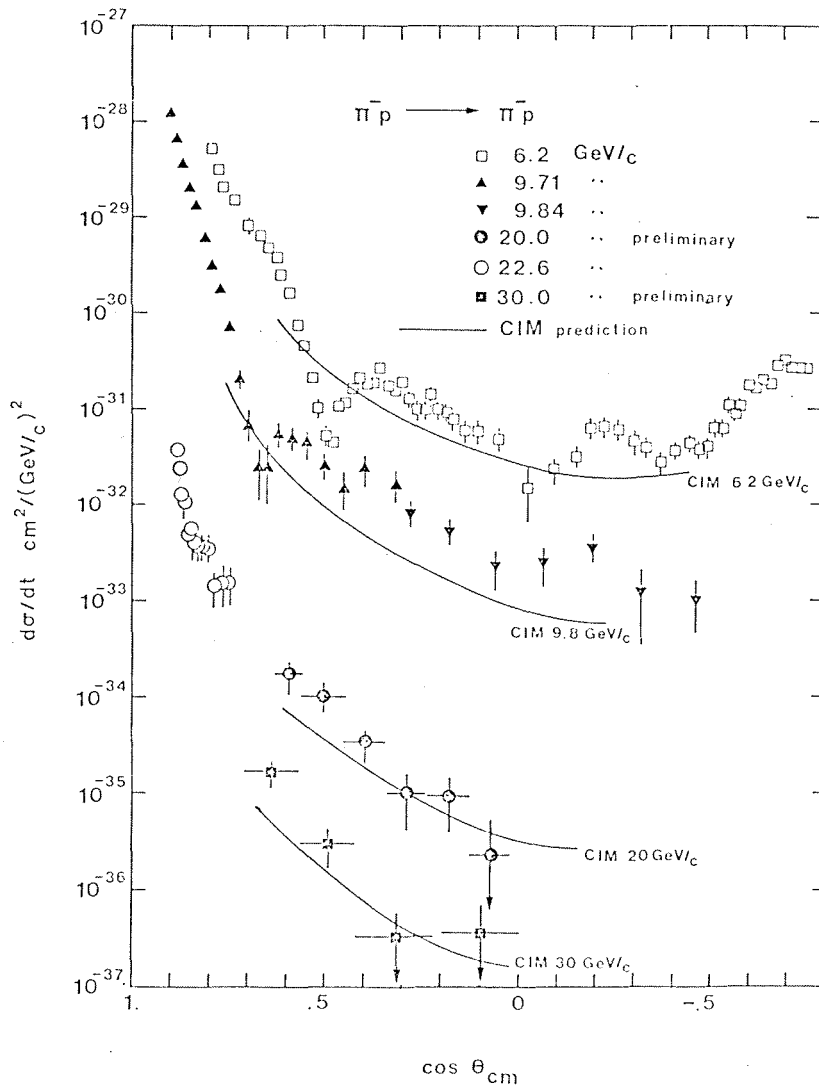

Figure 21.a) : Differential cross-section for  $\pi$ -p elastic scattering. The new results are at 20 and 30 GeV/c. CERN-Annecy-Genova-Copenhagen-Oslo-UC London Collaboration, Ref. 49. The solid lines correspond to a CIM fit to the  $\pi^+p$  data at 20 GeV/c.

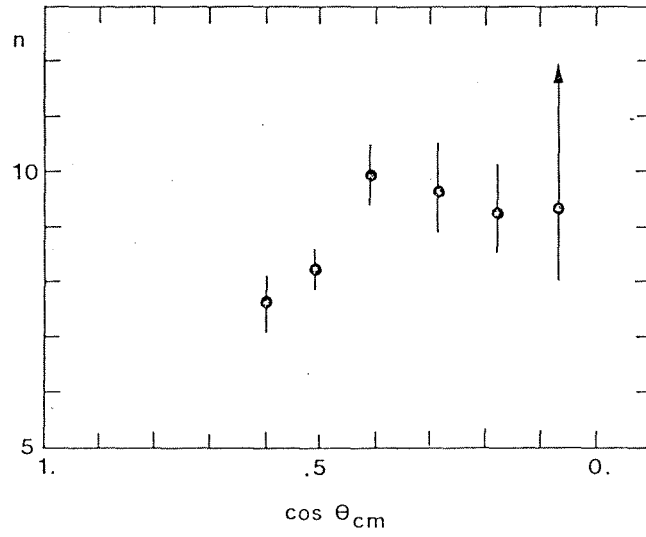

Figure 21.b) : The fitted  $n$  parameter at different scattering angles. It should be 8 in the CIM approach. Data at different energies (9.7 to 30 GeV) have been used.

$p_t$  phenomena stand out as a clear and beautiful example of hadron interactions at the constituent level.

At present one can see further investigations as developing along two main lines. On the one hand, and as already emphasized, great expectations are put on interactions at collider energies<sup>53</sup>). This is where spectacular effects are expected, with large counting rates for high- $p_t$  jets (Fig. 14) and where predictions based on QCD can be put to a thorough test. While many anticipated effects should show up in a clear way, or disprove through their absence some of our present ideas, it should be stressed that the values of  $x_t$  which will actually be accessible because of falling rates will remain small (at least at the  $p\bar{p}$  collider). Wide angle jets, which are more easily identifiable will thus be mainly associated with gluons according to present views. Clear valence-quark jets will have to be looked for as high-energy jets at small angles and sorting out jet fragments will be very difficult.

On the other hand, further studies at present energies (in the 200 - 2000 GeV range) thus offer the opportunity to analyse in some detail the relevance and fragmentation properties of different types of constituents. Extensive quantum number correlation studies and jet triggering should be possible with new detectors<sup>54</sup>). This should greatly enlarge the type of data available. While there is now some evidence that scaling violations and expected corrections are large enough to modify the basic QCD perturbative input in such a way as to reach reasonable agreement with the data, the actual amount of higher twist effects which may still be necessary is a challenging and topical question. Such processes could well contribute a significant amount to the single-particle trigger yield. Oddly enough, correlation studies with jet triggering could eventually be the best way to demonstrate their relevance. While QCD is a complete theory, what it predicts is not fully known yet and we may use experimentation for clues. The question of high- $p_t$  baryons and that of prompt photons certainly deserves further experimental investigation. In the latter case, the results reported at this Conference should be a great encouragement for further investigation.

#### ACKNOWLEDGEMENTS

I would like to express my gratitude to several experimental groups at the CERN-ISR for detailed discussions of their latest data, a fruitful collaboration with many colleagues which it is sad to translate here acrostically only: ABCS; BFS; CCHK; CCOR; CS. I am indebted to G. Fox for a very helpful exchange of correspondence and benefitted much from the reviews on high- $p_t$  physics presented by M. Tannenbaum, J. Owens and W. Selove at the 1979 Moriond meeting. I am indebted to R. Horgan for informative discussions and I would like to thank again here particularly P. Darriulat and P. Landshoff for a now long collaboration on high- $p_t$  physics. Ch. Redman has kindly brought this report to its present form.

## REFERENCES

- 1) High- $p_t$  phenomena have been discussed in a series of review articles which were written in turn as the analysis of high- $p_t$  hadronic processes gradually developed. An extensive survey is obtained from D. Sivers, S. Brodsky and R. Blankenbecler, Phys. Reports 23 C, 1 (1976); S. Ellis and R. Stroynowski, Rev. Mod. Physics 49, 753 (1977); M. Jacob and P.V. Landshoff, Phys. Reports 48, 285 (1978).
- 2) C.T. Sachrajda, Phys. Letters 40, 213 (1978); D. Amati, R. Petronzio and G. Veneziano, Nucl. Physics B 140, 54 (1978); 146, 29 (1978).
- 3) H.D. Politzer, Proc. XIX Internat. Conf. on High Energy Physics, Tokyo, 229 (1978 and M.K. Gaillard "QCD Phenomenology", Rapporteur talk at this Conference.
- 4) For a detailed survey of the applications of quantum chromodynamics to hard-scattering processes, see Yu. L. Dokshitzer, D.I. Dyakonov and S.I. Troyan, Phys. Reports, to be published (1979) and R. Field, La Jolla Lecture Notes (1978), Calt 68-696.
- 5) Proc. Copenhagen Meeting on "Jets in High Energy Collisions", Physica Scripta 19, 69 (1979).
- 6) Proc. XIX Internat. Conf. on High Energy Physics, Tokyo (1978). In particular: R. Sosnowski, 693 and R. Field, 743.
- 7) The new experimental results practically all come from the exploitation of large detectors which were already completed at the time of the Tokyo Conference. This review therefore does not have to present any of these detectors - a welcome excuse for a theorist rapporteur. The major new detectors of experiment R 807 at the CERN ISR is presently at the completion stage. References 1 and 5 can be consulted for a presentation of the major detectors at CERN and at Fermilab.
- 8) S. Brodsky, Physica Scripta 19, 154 (1979).
- 9) An extensive survey of precise rapidity correlations, as more recently obtained, is to be found in M.G. Albrow et al., Studies of Proton-Proton Collisions at the CERN-ISR with an identified charged hadron of high transverse momentum at  $90^\circ$ , Nucl. Phys. B, to be published (1979). CERN/EP/79-56.
- 10) R. Field and R.P. Feynman, Nucl. Phys. B 136, 1 (1978).
- 11) C. Kourkoumelis et al., Correlations of High Transverse Momentum  $\pi^0$  Pairs Produced at the CERN-ISR, CERN-EP 79-36, Nucl. Phys. to be published.
- 12) A. Clark et al., Large Transverse Momentum Jets in High Energy Proton-Proton Collisions, submitted to this Conference.
- 13) A. Angelis et al., Physica Scripta 19, 99 (1979), and contribution to this Conference.
- 14) G. Zech "Jets in  $e^+e^-$  Annihilation" Moriond meeting, Les Arcs (1979) - Preliminary Pluto data; P. Söding "Jet Analysis", Report to this Conference - Preliminary Tasso Data.
- 15) W.G. Scott "Neutrino '78", Int. Conf. on Neutrino Physics, Purdue University 1978 (ed. E.C.Fowler). J.C. Vander Welde, Physica Scripta 19, 173 (1979).
- 16) G. Sterman and S. Weinberg, Phys. Rev. Letters 39, 1436 (1977); E. Farhi, Phys. Rev. Letters 39, 1587 (1977).



- 17) This is the occasion to stress that quoting a mean value should not be enough since this assumes a particular shape which may change as  $p_t$  increases. To the extent that topical features are a Gaussian shape usually associated with the parametrization of the yet non-calculable fragmentation of each jet component, and a tailing distribution associated with the perturbative branching of the jet, having the full distribution is of great importance.

Even though there is at present no direct evidence in favour of QCD, it is impressive that no expectation based on QCD is found in sheer disagreement with any data. In view of the present interest raised by QCD it is therefore deemed appropriate to refer to its predictions at each stage at the risk of overdoing it.

- 18) S. Ellis et al., Nucl. Phys. B 108, 93 (1976); M. Jacob and P.V. Landshoff, Nucl. Phys. B 113, 395 (1976). The  $p_t^{-n}$  parametrization lumps together the  $p_t$  and  $x_t$  dependence, hence a rather high effective value for  $n$ . It is successful over a wide  $p_t$  range.
- 19) For a detailed discussion, see the general review of M. Tannenbaum, Proc. Moriond Meeting, Les Arcs (1979).
- 20) C. Bromberg et al., Phys. Rev. Letters 38, 1447 (1977); C. Bromberg et al., Nucl. Phys. B 134, 189 (1978); C. Bromberg et al., Phys. Rev. Letters 42, 1202 (1979).
- 21) R.P. Feynman, R. Field and G. Fox, Nucl. Phys. B 128, 1 (1977); Phys. Rev. D 18, 3320 (1978).
- 22) C. Bromberg et al., Jet Production in 200 GeV/c Hadron-Proton Collisions, Caltech preprint 1979. I am indebted to G. Fox for an exchange of correspondence. J. Rohlf, Caltech Thesis, in preparation.
- 23) D. Antreaseyan et al., Phys. Rev. Letters 38, 112, 115 (1978).
- 24) M. Deutschmann et al., Aachen III B/WA28-1 (1979).
- 25) W. Selove, High  $p_t$  Jet Studies at Fermilab, UPR-70 E (1979). Proceedings of the Moriond Meeting, Les Arcs (1979).
- 26) J.D. Björken, Acta Phys. Polon B 5, 145 (1974).
- 27) M.G. Albrow et al., Nucl. Phys. B 145, 305 (1978). K. Hansen, Proceedings of the Tokyo Conference.
- 28) H. Bøggild, Proc. Moriond Meeting, Les Arcs (1979); NBI/HE 79-6.
- 29) M.G. Albrow et al., Nucl. Phys. B 135, 461 (1978).
- 30) The Rapporteur has to trust the experimental collaborations in their reconstruction of the centre-of-mass energy for the two-jet system and their unfolding of all trigger bias effects. This requires involved Monte Carlo simulations.
- 31) G. Hanson, Moriond Meeting, Les Arcs (1978); SLAC PUB 2118 (1978); G. Hanson et al., Phys. Rev. Letters 35, 1609 (1975).
- 32) G. Wolf, "High Energy Trends", Rapporteur Talk at this Conference.
- 33) R. Horgan, CERN, private communication.
- 34) J. Gunion "The Realm of Gluons", UC Davis (1978); W. Furmanski and S. Pokorski, CERN th 2665 (1979). R. Field in Refs. 4, 5 and 6.
- 35) B. Combridge et al., Phys. Lett. 70 B, 234 (1978).
- 36) H. Jöstlein et al., Phys. Rev. Letters 42, 146 (1979).

- 37) R. Baier, J. Engels and B. Petersson, Symmetric Pairs at Large Transverse Momenta as a Test of Hard-Scattering Models, BI.TP 79/10.
- 38) B. Pope, Contribution to this Conference.
- 39) A. Contogouris et al., Phys. Rev. D 17, 2314 (1978).
- 40) J. Owens, Quantum Chromodynamics and Large Momentum Transfer Processes. Invited talk at the Coral Gables Conference "Orbis Scientiae" (1979).
- 41) C. Bromberg et al., "Production and Correlations of Charged Particles with High  $p_t$  in 200 GeV  $\pi^{\pm}p$ ,  $k^-p$  and  $pp$  Collisions", UCLA 1123 (1979).
- 42) D. Drijard et al., "Quantum Number Effects in Events with a Charged Particle at Large Transverse Momentum - 1", CERN/EP-78; "Quantum Number Effects in Events with a Charged Particle of Large Transverse Momentum - 2". Paper submitted to this Conference; D. Wegener, invited talk at this Conference.
- 43) C. Kourkoumelis et al., "Measurement of  $\pi^0$  Fragments from Jets Produced in  $pp$  Collisions at the CERN ISR", CERN-EP/79-57.
- 44) Z. Kunszt et al., DESY 79/28, 79/34 (1979). I am indebted to Z. Kunszt for an informative discussion on this point.
- 45) R. Field, Tokyo Conference, 743 (1978); A. Contogouris et al., Scale Violation Effects in Large  $p_t$  Direct Photon Production, McGill (1979).
- 46) R. Rückl et al., SLAC PUB 2115 (1978).
- 47) C. Kourkoumelis et al., Direct Production of High  $p_t$  Single Photons in  $pp$  Collisions at the CERN-ISR; paper contributed to this Conference.
- 48) C. Fabjan, Invited talk at this Conference.
- 49) E. Amaldi et al., Phys. Lett. 77 B, 240 (1978).
- 50) R. Almas et al., Meson-Proton Large-Angle Elastic Scattering at 20 and 30 GeV/c. Submitted paper to this Conference.
- 51) J. Gunion, Phys. Rev. D 8, 287 (1973).
- 52) R. Feynman, R. Field and G. Fox, Phys. Rev. D 18, 3320 (1978). G. Fox, "Application of Quantum Chromodynamics to High- $p_t$  Hadron Production". Invited talk at the Coral Gables Conference "Orbis Scientiae" (1978).
- 53) This applies to the SPS used as a  $p\bar{p}$  collider and later to the Fermilab doubler used the same way. This also applies to Isabelle; see BNL 50648.
- 54) Experiment R 807 for instance at the ISR. For a detailed review see ISR Workshop documents 2-7 and 2-14 (1977).