

The TOTEM Detector at LHC

G. Antchev¹, P. Aspell¹, I. Atanassov¹, V. Avati^{1,9}, V. Berardi⁴, M. Berretti⁵, M. Bozzo², E. Brücken⁶, A. Buzzo², F. Cafagna⁴, M. Calicchio⁴, M. G. Catanesi⁴, M. A. Ciocci⁵, M. Csanád¹⁰, T. Csörgő¹⁰, M. Deile¹, E. Dénes¹⁰, E. Dimovasil^{1,9}, M. Doubek¹¹, K. Eggert⁹, F. Ferro², F. Garcia⁶, S. Giani¹, V. Greco^{1,5}, L. Grzanka¹, J. Heino⁶, T. Hilden⁶, M. Janda¹¹, J. Kašpar^{1,7}, J. Kopal^{1,7}, V. Kundrať⁷, K. Kurvinen⁶, S. Lami⁵, G. Latino⁵, R. Lauhakangas⁶, E. Lippmaa⁸, M. Lokaříček⁷, M. Lo Vetere², F. Lucas Rodriguez¹, M. Macrí², G. Magazzù⁵, S. Minutoli², H. Niewiadomski^{1,9}, G. Notarnicola⁴, T. Novak¹⁰, E. Oliveri⁵, F. Oljemark⁶, R. Orava⁶, M. Oriunno¹, K. Österberg⁶, E. Pedreschi⁵, J. Petäjäljärvi⁶, M. Quinto⁴, E. Radermacher¹, E. Radicioni⁴, F. Ravotti¹, E. Robutti², L. Ropelewski¹, G. Ruggiero¹, A. Rummel⁸, H. Saarikko⁶, G. Sanguinetti⁵, A. Santroni², A. Scribano⁵, G. Sette², W. Snoeys¹, W. Spearman¹², F. Spinella⁵, A. Ster¹⁰, C. Taylor³, A. Trummal⁸, N. Turini^{1,5}, V. Vacek¹¹, M. Vitek¹¹, J. Whitmore⁹, J. Wu.¹

¹CERN, 1211 Geneve 23, Switzerland

²Università di Genova and Sezione INFN, Genova, Italy

³Case Western Reserve University, Dept. of Physics, Cleveland

⁴INFN Sezione di Bari and Politecnico di Bari, Bari, Italy

⁵INFN Sezione di Pisa and Università di Siena, Italy

⁶Helsinki Institute of Physics and Department of Physics, University of Helsinki, Finland

⁷Institute of Physics of the Academy of Sciences of the Czech Republic, Prague, Czech Republic

⁸National Institute of Chemical Physics and Biophysics NICPB, Tallinn, Estonia

⁹Penn State University, Dept. of Physics, University Park, PA, USA

¹⁰MTA KFKI RMKI, Budapest, Hungary

¹¹On leave from Czech Technical University, Prague, Czech Republic

¹²Fulbright fellow, individual participant from the University of Geneva, Switzerland.

The TOTEM experiment, small in size compared to the others at the LHC, is dedicated to the measurement of the total proton-proton cross-section with the luminosity-independent method and to the study of elastic and diffractive scattering. To achieve optimum forward coverage for charged particles emitted by the pp collisions in the interaction point IP5, two tracking telescopes, T1 and T2, are installed on each side in the pseudo-rapidity region between 3.1 and 6.5, and Roman Pot (RP) stations are placed at distances of 147 m and 220 m from IP5. The telescope closest to the interaction point (T1, centered at $z = 9$ m) consists of Cathode Strip Chambers (CSC), while the second one (T2, centered at 13.5 m), makes use of Gas Electron Multipliers (GEM). The proton detectors in the RPs are silicon devices designed by TOTEM with the specific objective of reducing down to a few tens of microns the insensitive area at the edge. High efficiency as close as possible to the physical detector boundary is an essential feature. It maximizes the experimental acceptance for protons scattered elastically or diffractively at polar angles down to a few micro-radians. To measure protons at the lowest possible emission angles, special beam optics have been developed, optimizing acceptance and resolution. The read-out of all TOTEM subsystems is based on the custom-designed digital VFAT chip with trigger capability.

1 Introduction

The Totem Experiment will measure the total pp cross-section and study elastic scattering and diffractive dissociation at LHC [1, 2]. The experimental apparatus is placed symmetrically with respect to the Interaction Point 5 (IP5) and the CMS experiment (Fig. 1). Two tracking

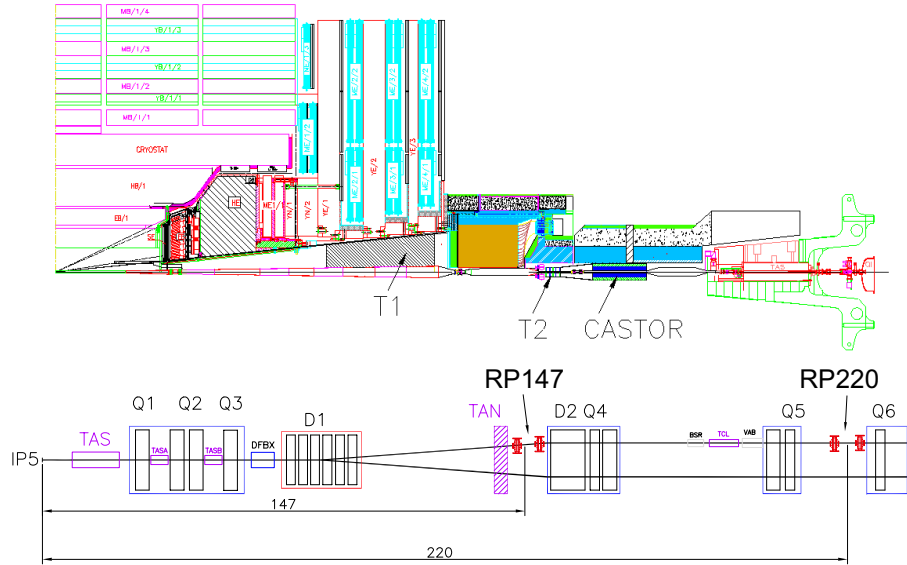

Figure 1: Top: The TOTEM forward telescopes T1 and T2 embedded in the CMS experiment together with the CMS forward calorimeter CASTOR. Bottom: The LHC beam line and the Roman Pots at 147 m (RP147) and 220 m (RP220).

telescopes, T1 and T2, will measure the inelastic interactions in the forward region covering an adequate acceptance over a rapidity interval of $3.2 \leq \eta \leq 6.5$. T1 is placed between two conical surfaces, the beam pipe and the inner envelope of the flux return yoke of the CMS end-cap, at a distance between 7.5 m and 10.5 m from the IP5, while T2 is installed at about 13.5 m in the forward shielding of CMS, between the vacuum chamber and the inner shielding of the HF calorimeter. The measurement of $\frac{d\sigma_{el}}{dt}$ down to $-t = 10^{-3} \text{ GeV}^2$ is accomplished by silicon detectors placed in Roman Pots located at 147 m and 220 m from IP5. Since the beam of the LHC is rather thin, with a 10σ envelope of about 1 mm, the detectors in the Roman Pot must have a very small dead zone at the mechanical edge facing the beam. In the following sections, the different detectors will be described and their status reviewed.

2 The Inelastic Telescopes T1 and T2

The T1 and T2 telescopes will be employed to trigger and partially reconstruct inelastic events. Together they must provide a fully inclusive trigger for diffractive events and enable the reconstruction of the vertex of an event, in order to disentangle beam-beam events from the background. Each telescope is made of two arms, symmetrically placed with respect to IP5.

Each arm of T1 is composed of five planes of Cathode Strip Chambers, with six chambers per plane covering roughly a region of 60° in ϕ . It is split in two halves and mounted on two different supports. A picture of one half of a T1 arm is shown in Fig. 2. In each chamber, the

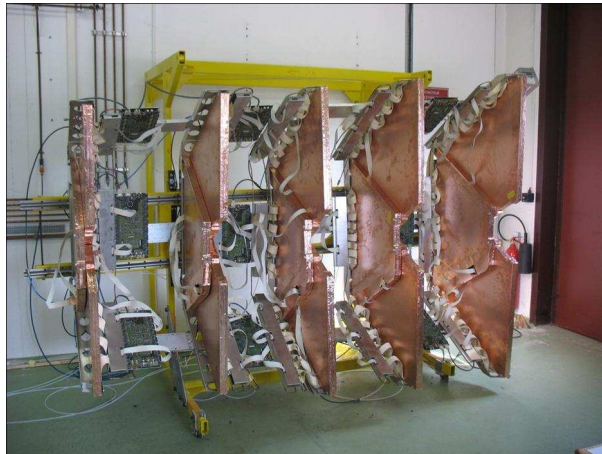

Figure 2: One quarter of the T1 telescope mounted on its support structure.

readout strips of the two cathode planes are oriented $\pm 60^\circ$ with respect to the anode wires. This allows the measurement of three coordinates for each particle track, which significantly helps in resolving multiple events. To improve pattern recognition, the planes are rotated by 3° with respect to each other. The production of the CSCs with their readout cards and the support structure has been completed and qualified, and the system is taking test data with cosmic rays. The T2 telescopes are made of triple Gas Electron Multipliers (GEM) [3]. GEMs are gas-filled detectors featuring the advantageous decoupling of the charge amplification structure from the charge collection and readout structure. Furthermore, they combine good spatial resolution with very high rate capability and a good resistance to radiation. Each of the two telescope arms is made of two sets of 10 aligned detector planes with almost semicircular shape, mounted on each side of the vacuum pipe. To avoid efficiency losses on the boundaries, the angular coverage of each half plane is more than 180° . The readout of the half planes has two separate layers with different patterns: one with 256 concentric rings, $80\ \mu\text{m}$ wide and with a pitch of $400\ \mu\text{m}$, providing the radial coordinates of traversing tracks with a good precision, and the other with a matrix of 1536 pads varying in size from $2 \times 2\ \text{mm}^2$ to $7 \times 7\ \text{mm}^2$, used for triggering. An illustration of a GEM chamber is shown in Fig. 3 (left). Both arms of T2 have been installed in their final locations. A picture of the T2 arm during the installation, right before the insertion in the CMS HF calorimeter is shown in Fig. 3 (right).

The production of the chambers has been followed by a series of acceptance tests before their assembly in half arms. Moreover, before the installation, each half arm of T2 has been extensively tested for data taking with cosmic rays. The measured and the simulated efficiency for each of the ten planes of one quarter of T2 are compared in Fig. 4.

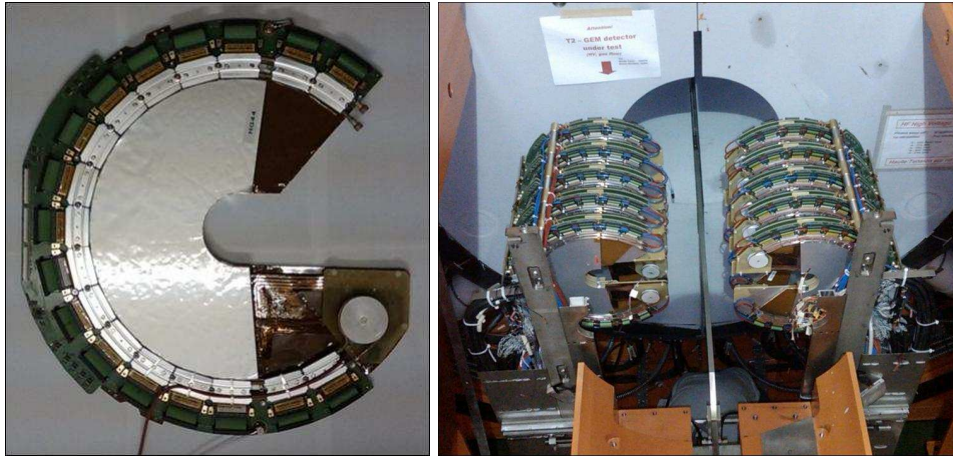

Figure 3: Left: GEM chamber assembled with its horseshoe-shaped readout card. Right: One arm of the T2 telescope just before the insertion in the CMS HF calorimeter.

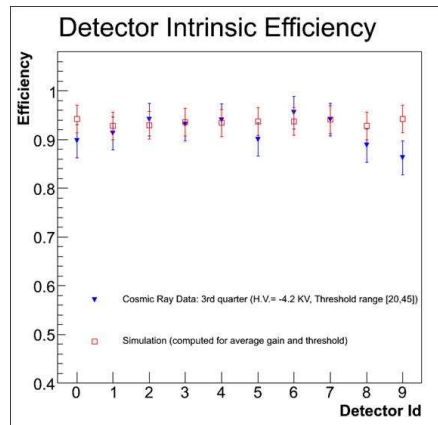

Figure 4: Comparison of the efficiency measured and simulated for each of the ten planes of the 3rd quarter of T2 with all the chambers at the nominal bias of 4.2 kV. For data taking, the threshold of the binary readout chips spanned the range from 20 to 45 DAC units, while for the simulation an average threshold was used for all the chips.

3 The Roman Pots

The Roman Pots are special beam pipe insertions, which allow bringing the detectors very close to the beam without interfering with the primary vacuum of the machine. Each RP station is made of two units separated by 4 m and equipped with one horizontal and two vertical pots. A photo of a fully installed unit is shown in Fig. 5 (left). Given the challenging constraints of the LHC machine, such as high beam energy, ultra high vacuum and the required physics performance of TOTEM, which needs to have active detectors at ~ 1 mm from the LHC beam centre, a special design has been developed. A main issue has been the welding technology

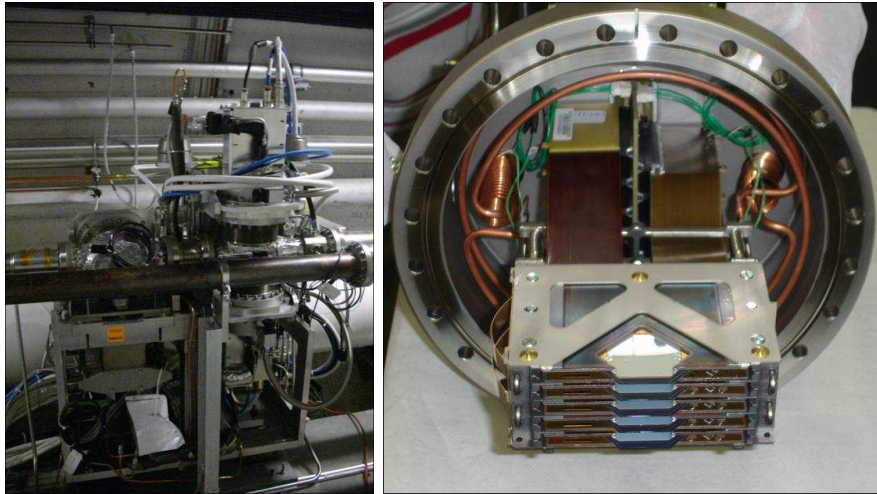

Figure 5: Left: A Roman Pot unit with two vertical and one horizontal pot installed in the LHC tunnel. Right: One of the detector packages mounted in all pots of the RP System.

employed for the thin window that separates the vacua of the machine and the Roman Pot, still minimizing the distance of the detector from the beam. As result of this development, a thickness and a planarity of less than $150\ \mu\text{m}$ and $20\ \mu\text{m}$ respectively have been achieved for the thin windows produced. In each pot, a detector package made of 10 planes is inserted, with the sensors approaching the thin window to few hundreds of microns. The single-sided silicon microstrip detectors have been fabricated with planar technology, with the special characteristic of reaching full sensitivity within $50\ \mu\text{m}$ from the cut edge. The detector package is operated at -30°C by means of evaporative cooling and is kept in a controlled atmosphere with pressure between 10 mbar and 100 mbar. The microstrip sensors have a diamond-like shape and parallel strips oriented at 45° with respect to the side of the sensor facing the beam. The planes of the detector package are mounted back-to-back in pairs (flipped around the vertical axis), in order to have their strips oriented mutually orthogonal. The strip pitch of $66\ \mu\text{m}$ is adequate to achieve a resolution of less than $20\ \mu\text{m}$. A photo of a detector package is shown in Fig. 5 (right).

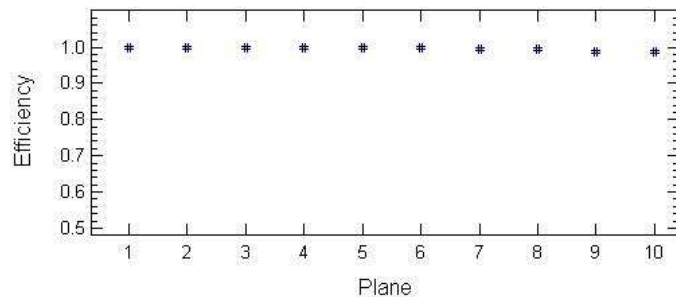

Figure 6: Efficiency measured for each of the ten planes of one detector package. The relative error on these measurements is less than 1%.

These silicon detectors, developed by the TOTEM Collaboration and also known as *planar edgeless silicon detectors with current-terminating structure (CTS)* [4], use a newly conceived design, which prevents breakdown and surface current injection at high bias, while simultaneously providing extremely reduced dead zones at the edges. Moreover, radiation hardness studies indicate that – when operated under moderate cooling – the detectors remain fully efficient up to a fluence of about 1.5×10^{14} p cm⁻². All the Roman Pot Stations equipped with thin windows have been installed in the LHC tunnel in 2007. The detector packages, on the other hand, are being assembled and installed as they become available. A sequence of tests is performed during their assembly, including a run of data taking with particle beams or cosmic rays. The efficiency for one of the assembled detector packages measured with muons is shown in Fig. 6.

The stations at 220 m have received the first detector packages during the summer of 2008, and are now all equipped, with the last installations completed in July 2009. The installation of the detector packages in the stations at 147 m are foreseen only after the first run of LHC.

4 The TOTEM Electronics System

The TOTEM sub-detector systems (RP, T1, T2), based on different sensor technologies, are controlled and read out independently. However, they make use of a common electronics system architecture, based on the VFAT [5] chip. The VFAT has been designed specifically for the readout of sensors in the TOTEM experiment and has trigger and tracking capabilities. Moreover, it is able, on one side, to accommodate the considerable differences in signal properties of the three detector types and, on the other side, to be fully compatible with the CMS readout in view of common runs at a later stage. Figure 7 shows a basic block diagram of the functional components used in the system. It is subdivided into geographically separated regions and data flow. The so-called “On Detector regions” are located as close as possible to the detector. The “Local Detector regions” coincide with the readout boards in the vicinity of the detector (where the distributing control signals are grouped). A detailed description of the TOTEM Electronics System can be found in [6].

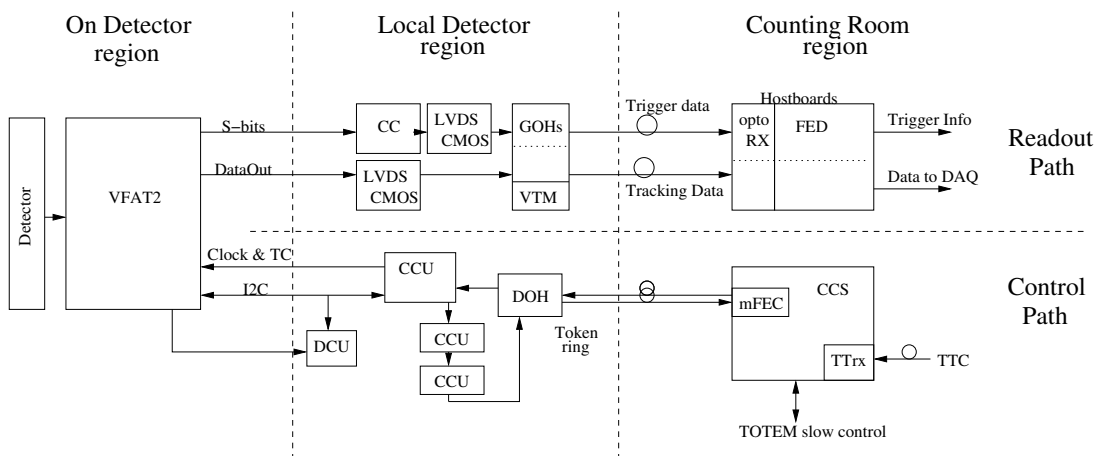

Figure 7: Functional block diagram of the TOTEM electronics system architecture.

5 Conclusions

The TOTEM Collaboration has installed most of its detectors in IP5. All the detectors are commissioned prior to the installation, including their electronics and readout systems. The relatively small dimension, the forward orientation and the specific placement of these detectors in the IP5 cavern and in the tunnel, have demanded a commissioning with particles on the surface with cosmic rays and – when possible – with particle beams. Today, the installation of the telescope T2 and of the Roman Pots at 220m is complete. Both detectors have been validated after a commissioning phase done with beam particles. The commissioning of the telescope T1 is taking place now.

Acknowledgements

This work was made possible by grants from CERN (Geneva, Switzerland), the Istituto Nazionale di Fisica Nucleare (Italy), the Institute of Physics of the ASCR, v.v.i. (Praha, Czech Republic), the Estonian Academy of Sciences (Tallinn, Estonia), the Hungarian National Science Fund OTKA (grants HA07-C 74458 and NK-73143), the Helsinki Institute of Physics HIP and Department of Physical Sciences (Helsinki, Finland), the Case Western Reserve University, Dept. of Physics, (Cleveland, OH, USA), and the Penn State University, Dept. of Physics (University Park, PA, USA). We gratefully acknowledge their support.

References

- [1] TOTEM TDR, CERN-LHCC-2004-002, TOTEM-TDR-001, 7 January 2004; addendum CERN-LHCC-2004-020.
- [2] G. Anelli et al., “The TOTEM Experiment at the CERN Large Hadron Collider”, 2008 JINST 3 S08007.
- [3] F. Sauli, “GEM: A new concept for electron amplification in gas detectors”, Nucl. Instrum.Meth. A 386 (1997) 531.
- [4] G. Ruggiero et al., “Planar edgeless silicon detectors for the TOTEM experiment”, IEEE Trans. Nucl. Sci. 52 (2005) 1899.
- [5] P. Aspell et al., “VFAT2: a front-end system on chip providing fast trigger information...”, proceedings of TWEPP-07, Topical Workshop on Electronics for Particle Physics, Prague Czech Republic (2007), <http://cdsweb.cern.ch/record/1069906> .
- [6] W. Snoeys et al.. “The TOTEM electronics system”, proceedings of TWEPP-07, Topical Workshop on Electronics for Particle Physics, Prague Czech Republic (2007), <http://cdsweb.cern.ch/record/1089268> .