

# One-loop $\overline{MHV}$ amplitudes using the unitarity bootstrap: the general helicity case

---

E. W. Nigel Glover, Pierpaolo Mastrolia<sup>Y</sup>, Ciaran Williams

Department of Physics, University of Durham, Durham, DH1 3LE, UK

<sup>Y</sup>Theory Division, CERN CH-1211 Geneva 23, Switzerland

E-mails: e.w.n.glover@durham.ac.uk, Pierpaolo.Mastrolia@cern.ch,  
Ciaran.Williams@durham.ac.uk.

**Abstract:** We consider a Higgs boson coupled to gluons via the five-dimensional effective operator  $H \text{tr} G^2$ . We treat  $H$  as the real part of a complex field that couples to the self-dual gluon field strengths and compute the one-loop corrections to the  $\overline{MHV}$  amplitudes involving  $n$ , two negative helicity gluons and an arbitrary number of positive helicity gluons. Our results generalise earlier work where the two negative helicity gluons were constrained to be colour adjacent. We use four-dimensional unitarity to construct the cut-containing contributions and the recently developed recursion relations to obtain the rational contribution for an arbitrary number of external gluons. We solve the recursion relations and give explicit results for up to four external gluons. These amplitudes are relevant for Higgs plus jet production via gluon fusion in the limit where the top quark mass is large compared to all other scales in the problem.

April 17, 2013

**Keywords:** QCD, Higgs boson, Hadron Colliders.

## 1. Introduction

The startup of the LHC anticipated for the autumn of 2008 heralds the arrival of a new arena for the exploration of particle physics. The large centre of mass energy is expected to produce complex multiparticle final states both as decay products of putative new physics Beyond the Standard Model and through the Standard Model itself. Extracting the signals of new phenomena and discriminating between different models of new physics is only possible if the predictions for the Standard Model, and its prominent extensions, have sufficient accuracy. The precision which can be achieved using calculations at leading order in perturbation theory is, in most cases, not sufficient for detailed studies of signals and especially backgrounds at the LHC. In many cases, the calculation of multi-particle final states at next to leading order (NLO) will be essential to the successful interpretation of the data. Over the past few years vast leaps in our understanding of the structure of one-loop amplitudes in gauge theories has led to the widespread belief that soon predictions for many multi-jet final states will soon become available.

The use of four-dimensional on-shell techniques, originally pioneered by Bern et al [1, 2] in the mid-90's has led to a vast reduction in the complexity of one-loop calculations. The use of gauge-invariant physical amplitudes (at tree level) as building blocks means that simplifications due to the large cancellation of Feynman diagrams occur in the preliminary stages of the calculation, rather than the latter. The unitarity method sews together four-dimensional tree-level amplitudes and, using unitarity to reconstruct the (poly)logarithmic cut-constructible part of the amplitude, successfully reproduces the coefficients of the cut-constructible pieces of a one-loop amplitude. This has extensive uses in supersymmetric Yang-Mills theories, which are cut-constructible i.e. the whole amplitude can be reconstructed from knowledge of its discontinuities.

The more modern applications of unitarity were kick-started by the discovery of the MHV rules by Witten and collaborators in 2004 [3]. The realisation that MHV tree amplitudes could be promoted to vertices which could be used to create amplitudes with any number of negative helicity gluons sparked a revolution in the field of on-shell QCD. In a series of remarkable papers, Brandhuber, Spence and Travaglini (BST) [4] showed how the MHV rules can be used at one-loop for the calculation of  $n$ -point gluonic MHV amplitudes. Around the same time, the quadruple cut [5] using complex momenta was introduced to reduce the determination of the coefficients of box integrals to simple algebraic manipulation of four tree level amplitudes. Double and triple unitarity cuts have led to direct techniques for extracting triangle and bubble integral coefficients analytically [6-9]. In cases where fewer than four denominators are cut, the loop momentum is not frozen, so the explicit integration over the phase space is still required. In the BCFM approach [6-8], double or triple cut phase-space integration has been reduced to extraction of residues in spinor variables, and, in the case of a triple cut, residues in a Feynman parameter. This method has been recently used for the evaluation of the complete six-photon amplitudes [10, 11].

Despite its success, the four-dimensional unitarity method does not give the complete

result for non-supersymmetric theories such as QCD, since there are missing rational functions which are cut-free and as result do not possess discontinuities in physical channels. The missing rational parts have only simple poles and are therefore tree-like. Since the rational pieces of one-loop amplitudes are tree like in their discontinuity structure they can be calculated using a straightforward generalization of the tree level recursion relations. One can then use the tree-level on-shell recursion relations [12, 13] to compute the rational pieces of one-loop amplitudes recursively. The ability to calculate the rational pieces of amplitudes independently of the cut-constructible terms lead to the development of the unitarity bootstrap approach [14-20]. Recently, an automated package BlackHat has been developed to compute these rational terms for pure QCD amplitudes [21].

Another approach is to extend use of unitarity to  $D = 4 - 2\epsilon$  dimensions [8, 22-27] and to take the cut particles into  $D = 4 - 2\epsilon$  dimensions. This approach has the great advantage of calculating both the cut containing and the elusive rational terms at once, but care must be taken with application of the four-dimensional spinor helicity formalism in  $D$  dimensions.

It has also been observed that the rational parts are related to the ultraviolet behaviour of the amplitude, and can be directly obtained from the traditional Feynman diagram approach [10, 28-30]. In a very interesting work, Ossola, Papadopoulos and Pittau [31] have applied the unitarity ideas directly to the integrand of the Feynman amplitude, without necessarily appealing to the simplified forms of the cut diagrams. They find algebraic identities which can be automatically solved to give the coefficients of the master integrals as well as the rational part. This approach is being further developed [32-38] with a view to providing automated computations of both cut-constructible and rational parts of one-loop scattering amplitudes. A summary of the current state of the art is given in Ref. [39].

In this paper, we exploit the unitarity bootstrap approach [14-19] which meshes together the calculation of the cut-constructible parts of an amplitude (via generalised unitarity, one-loop MHV rules etc.) with the ability of the BCFW recursion relations to calculate the rational pieces. As a result of the splitting the total amplitude is given by the combination

$$A_n^{(1)} = C_n + R_n : \tag{1.1}$$

Here the  $C_n$  are the purely cut-constructible pieces which arise from box, triangle and bubble (and in massive theories tadpole) loop integrals, the functions in  $C_n$  are those which contain discontinuities, in general poly-logarithms (and associated  $\epsilon^{-2}$  terms).  $C_n$  may contain unphysical singularities which are produced by tensor loop integrals and must be cancelled by rational contributions. To make this cancellation explicit, we add the cut-completion terms  $CR_n$ , so that the "full" cut-constructible pieces are defined as,

$$\hat{C}_n = C_n + CR_n : \tag{1.2}$$

These additional rational terms would be double counted if we naively calculated the rational terms with the BCFW recursion relations, so we redefine the rational pieces as

$$\hat{R}_n = R_n - CR_n; \quad (1.3)$$

The rational part now contains only simple poles, and can, in principle, be constructed recursively using the multiparticle factorisation properties of amplitudes. We label this direct recursive term by  $R_n^D$ . By construction, the recursive approach generates the complete residues of physical poles. However, the cut-completion term  $CR_n$  may also produce a contribution at the residue of the physical poles, and may lead to double counting. These potential unwanted contributions are removed by the overlap terms,  $O_n$ .

To generate the recursive contribution, one generally shifts two of the external momenta by an amount proportional to  $z$ . Complex analysis [13] then generates the correct amplitude provided that

$$A_n(z) \rightarrow 0 \quad \text{as} \quad z \rightarrow \infty; \quad (1.4)$$

For a generic tree-level process it is frequently possible to shift two momenta such that (1.4) is obeyed. Similarly, for one-loop processes, one can often make a similar shift. However, because the choice of  $CR_n$  is not unique, the shift may introduce a "spurious" large  $z$  behaviour in  $CR_n$ , labelled by  $\text{Inf}CR_n$ , which should be explicitly removed [18, 19]. The rational part (provided that  $A_n(z) \rightarrow 0$  as  $z \rightarrow \infty$ ) is given by,

$$\hat{R}_n = R_n^D + O_n - \text{Inf}CR_n; \quad (1.5)$$

while the physical one-loop amplitude is given by [18, 19],

$$A_n^{(1)} = C_n + CR_n + R_n^D + O_n - \text{Inf}CR_n; \quad (1.6)$$

In this paper, we focus on the  $\mathcal{M}HV$  amplitudes involving  $n$ , two negative helicity gluons and an arbitrary number of positive helicity gluons. Our results generalise earlier work [20] where the two negative helicity gluons were constrained to be colour adjacent. The paper proceeds as follows. In section 2, we give a brief overview of the Higgs couples to gluons, and how this is related to  $\mathcal{M}HV$  amplitudes. Section 3 reviews the four-dimensional unitarity methods for constructing the cut-containing contribution  $C_n$ . There are many similarities with the pure-gluon case, and we develop the derivation of the cut-constructible parts of pure-gluon  $\mathcal{M}HV$  amplitudes and  $\mathcal{M}HV$  amplitudes in sections 3.3 and 3.4. Section 4 deals with computation of the three separate rational pieces, the cut-reconstructible part  $CR_n$ , the on-shell recursive part  $R_n^D$  and the overlap term  $O_n$ . As an example, we derive the four-point amplitudes  $A_4^{(1)}(\gamma; 1^-, 2^+, 3^-, 4^+)$  and  $A_4^{(1)}(H; 1^-, 2^+, 3^-, 4^+)$  in section 5, while section 6 describes the checks we have performed on our result. Finally, in section 7, we present our conclusions. Two appendices detailing the explicit construction of the cut-completion terms and the forms of the one-loop basis functions are enclosed.

## 2. The Higgs Model

The coupling of the Higgs to gluons in the Standard Model is produced via a fermion loop. Since the Yukawa coupling depends on the mass of the fermion, the interaction is dominated by the top quark loop. For large  $m_t$  this can be integrated out, leading to an effective interaction,

$$L_H^{\text{int}} = \frac{C}{2} H \text{tr} G^2 \quad (2.1)$$

This approximation works very well when the kinematic scales involved are smaller than twice the top quark mass [40-42]. For the interesting  $pp \rightarrow H$  plus two jet process, the approximation is valid when  $m_H, p_{Tj} < m_t$  [43]. The strength of the interaction  $C$  has been calculated through to order  $O(\frac{4}{s})$  in the standard model [44]. To order  $O(\frac{2}{s})$  [45], this is

$$C = \frac{s}{6v} \left( 1 + \frac{11}{4} \frac{s}{4} + \dots \right) \quad (2.2)$$

The MHV-structure of Higgs-plus-gluons is best understood [46] by defining the Higgs to be the real part of a complex scalar  $\phi = \frac{1}{2}(H + iA)$  so that

$$L_H^{\text{int}} = C \left( \text{tr} G_{SD}^2 - G_{SD}^i G_{SD}^i + \text{tr} G_{ASD}^2 - G_{ASD}^i G_{ASD}^i \right) \quad (2.3)$$

where the purely selfdual (SD) and purely anti-selfdual gluon field strength tensors are given as

$$G_{SD} = \frac{1}{2}(G + \tilde{G}) \quad G_{ASD} = \frac{1}{2}(G - \tilde{G}); \quad (2.4)$$

with

$$\tilde{G} = \frac{i}{2} G^{\mu\nu} \epsilon_{\mu\nu\rho\sigma} G^{\rho\sigma} \quad (2.5)$$

Because of selfduality, the amplitudes for  $\phi$  and  $\tilde{\phi}$  have a simpler structure than those for the Higgs field [46]. The following relations allow for the construction of Higgs amplitudes from those involving  $\phi$  and  $\tilde{\phi}$ .

$$A_n^{(m)}(H; g_1^{-1}; \dots; g_n^{-1}) = A_n^{(m)}(\phi; g_1^{-1}; \dots; g_n^{-1}) + A_n^{(m)}(\tilde{\phi}; g_1^{-1}; \dots; g_n^{-1}); \quad (2.6)$$

$$A_n^{(m)}(A; g_1^{-1}; \dots; g_n^{-1}) = \frac{1}{i} \left( A_n^{(m)}(\phi; g_1^{-1}; \dots; g_n^{-1}) - A_n^{(m)}(\tilde{\phi}; g_1^{-1}; \dots; g_n^{-1}) \right); \quad (2.7)$$

Furthermore parity relates  $\phi$  and  $\tilde{\phi}$  amplitudes,

$$A_n^{(m)}(\tilde{\phi}; g_1^{-1}; \dots; g_n^{-1}) = A_n^{(m)}(\phi; g_1^{-1}; \dots; g_n^{-1}) \quad (2.8)$$

From now on, we will only consider  $\phi$ -amplitudes, knowing that all others can be obtained using eqs. (2.6)-(2.8).

The tree level amplitudes linking a quark with  $n$  gluons can be decomposed into colour ordered amplitudes as [47, 48],

$$A_n^{(0)}(k_i; i; a_i; g) = iC g^{n-2} \sum_{2S_n = Z_n} \text{tr}(T^{a_1} \dots T^{a_n}) A_n^{(0)}(1; (1^+; \dots; n^-)): \quad (2.9)$$

Here  $S_n = Z_n$  is the group of non-cyclic permutations on  $n$  symbols, and  $j^j$  labels the momentum  $p_j$  and helicity  $\lambda_j$  of the  $j^{\text{th}}$  gluon, which carries the adjoint representation index  $a_i$ . The  $T^{a_i}$  are fundamental representation  $SU(N_c)$  colour matrices, normalized so that  $\text{Tr}(T^a T^b) = \delta^{ab}$ . The strong coupling constant is  $\alpha_s = g^2/(4\pi)$ .

Tree-level amplitudes with a single quark-antiquark pair can be decomposed into colour-ordered amplitudes as follows,

$$A_n^{(0)}(k_i; i; a_i; g; k_j; j; a_j; g) = iC g^{n-2} \sum_{2S_{n-2}} (T^{a_1} \dots T^{a_{n-1}})_{i_1 i_n} A_n^{(0)}(1; (2^+; \dots; (n-1)^{n-1}); n^-): \quad (2.10)$$

where  $S_{n-2}$  is the set of permutations of  $(n-2)$  gluons. Quarks are characterised with fundamental colour label  $i_j$  and helicity  $\lambda_j$  for  $j = 1; n$ . By current conservation, the quark and antiquark helicities are related such that  $\lambda_1 = -\lambda_n$  where  $\lambda = \pm \frac{1}{2}$ .

The one-loop amplitudes which are the main subject of this paper follow the same colour ordering as the pure QCD amplitudes [1, 49] and can be decomposed as [20, 50, 51],

$$A_n^{(1)}(k_i; i; a_i; g) = iC g^n \sum_{c=1}^{n-2} \sum_{2S_n = S_{n,c}} G_{n,c}(1) A_n^{(1)}(1; (1^+; \dots; n^-)) \quad (2.11)$$

where

$$G_{n,c}(1) = N \text{tr}(T^{a_1} \dots T^{a_n}) \quad (2.12)$$

$$G_{n,c}(1) = \text{tr}(T^{a_1} \dots T^{a_c}) \text{tr}(T^{a_{c+1}} \dots T^{a_n}); c > 2: \quad (2.13)$$

The sub-leading terms can be computed by summing over various permutations of the leading colour amplitudes [1]

The tree level  $-M$  HV amplitude has the same form as the pure-gluon  $M$  HV amplitude,

$$A_n^{(0)}(1; 2^+; \dots; m^-; \dots; n^+) = \frac{h_{1m} i^4}{h_{12i} \dots h_{n1i}}: \quad (2.14)$$

The only difference between the gluon only and the  $-M$  HV amplitude being momentum conservation, here the sum of all the gluon momenta equals  $-p$ . Since we will encounter  $M$  HV diagrams in which a fermion circulates in the loop we will also need the amplitudes involving a quark with a quark-antiquark pair [52],

$$A_n^{(0)}(1_q; 2^+; \dots; m^-; \dots; n_{\bar{q}}^+) = \frac{h_{1m} i^3 h_{nmi}}{h_{12i} \dots h_{n1i}};$$

$$A_n^{(0)}(1_{\bar{q}}^+; 2^+; \dots; m^-; \dots; n_{\bar{q}}^-) = \frac{h_{nm} i^3 h_{1mi}}{h_{12i} \dots h_{n1i}}: \quad (2.15)$$

Also as a consequence of the 1-loop nature of the  $n$ -gluon vertex the following all minus amplitude is non-zero at tree-level;

$$A_n^{(0)}(1^-, 2^-, \dots, n^-) = (-1)^n \frac{m^4}{[12] \dots [n-1]}; \quad (2.16)$$

Amplitudes with fewer (but more than two) negative helicities have been computed with Feynman diagrams (up to 4 partons) in Ref. [48] and using MHV rules and on-shell recursion relations in Refs. [46, 52]. The MHV amplitude for an arbitrary number of gluons but with two adjacent negative helicity gluons was computed in Refs. [20, 53].

In this paper we concentrate on the general helicity case for the one-loop  $n$ -MHV amplitude. For definiteness, we focus on the specific helicity configuration  $(1^-, \dots, m^-, \dots, n^+)$ . Throughout, we will use the notation,

$$\begin{aligned} s_{i,j} &= (p_i + p_{i+1} + \dots + p_j)^2 = P_{(i,j)}^2 \\ s_{ij} &= 2(p_i \cdot p_j) = h_i h_j [j i]; \end{aligned} \quad (2.17)$$

with the exception of section 5 where we use the notation  $P_{abc}$  to represent  $p_a + p_b + p_c$ .

### 3. The cut-constructible parts

The calculation of the cut-constructible terms has been performed within both the BST approach [4] and the BBCFM approach [6, 7]. Both methods rely on reconstructing the amplitude using four-dimensional unitarity with a double cut. Compared to conventional methods, one is attempting to compute the (four-dimensional) coefficients of the loop integrals as efficiently as possible. The methods differ in how the integration over the phase space of the cut particles is carried out. The BST method uses Passarino-Veltman techniques to eliminate any remaining tensor integrals, and aims to cast the integrand into the form of well-known phase space integrals. It has been shown to work well for MHV amplitudes.

On the other hand, in the BBCFM method, the use of spinor variables yields an alternative to the Passarino-Veltman reduction of tensor integrals, based on spinor algebraic manipulation and integration of complex analytic functions. It has been applied successfully to non-MHV amplitudes. Here, we use both methods as a check of our results.

#### 3.1 The BST approach

In the BST approach [4] a generic diagram can be written:

$$D = \frac{1}{(2\pi)^4} \int^Z \frac{d^4 L_1}{L_1^2} \frac{d^4 L_2}{L_2^2} {}^{(4)}(L_1, L_2, P) A_L(l_1; P; l_2) A_R(l_2; P; l_1) \quad (3.1)$$

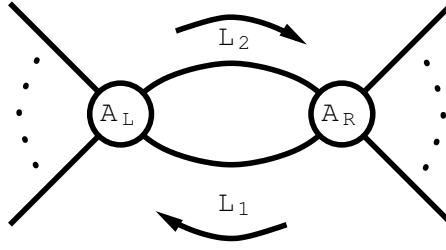

Figure 1: A generic one-loop MHV diagram or unitarity cut.

where  $A_{L(R)}$  are the amplitudes for the left(right) vertices and  $P$  is the sum of momenta incoming to the right hand amplitude. The key step in the evaluation of this expression is to re-write the integration measure as an integral over the on-shell degrees of freedom and a separate integral over the complex variable  $z$  [4]:

$$\begin{aligned} \frac{d^4 L_1}{L_1^2} \frac{d^4 L_2}{L_2^2} &= (4i)^2 \frac{dz_1}{z_1} \frac{dz_2}{z_2} d^4 l_1 d^4 l_2 \binom{+}{l_1^2} \binom{+}{l_2^2} \\ &= (4i)^2 \frac{2dzdz^0}{(z-z^0)(z+z^0)} d^4 l_1 d^4 l_2 \binom{+}{l_1^2} \binom{+}{l_2^2}; \end{aligned} \quad (3.2)$$

where  $z = z_1 - z_2$  and  $z^0 = z_1 + z_2$ . The integrand can only depend on  $z; z^0$  through the momentum conserving delta function,

$$\delta^{(4)}(L_1 + L_2 - P) = \delta^{(4)}(l_1 + l_2 - P + z) = \delta^{(4)}(l_1 + l_2 - \mathbb{P}); \quad (3.3)$$

where  $\mathbb{P} = P - z$ . This means that the integral over  $z^0$  can be performed so that,

$$\begin{aligned} D &= \frac{(4i)^2 2}{(2)^4} \int \frac{dz}{z} \frac{d^4 l_1 d^4 l_2 \binom{+}{l_1^2} \binom{+}{l_2^2} \delta^{(4)}(l_1 + l_2 - \mathbb{P}) A_L(l_1; P; l_2) A_R(l_2; P; l_1)}{z} \\ &= (4i)^2 2 \int \frac{dz}{z} \text{dLIPS}^{(4)}(l_1; l_2; \mathbb{P}) A_L(l_1; P; l_2) A_R(l_2; P; l_1); \end{aligned} \quad (3.4)$$

where,

$$\text{dLIPS}^{(4)}(l_1; l_2; \mathbb{P}) = \frac{1}{(2)^4} d^4 l_1 d^4 l_2 \binom{+}{l_1^2} \binom{+}{l_2^2} \delta^{(4)}(l_1 + l_2 - \mathbb{P}) \quad (3.5)$$

The phase space integral is regulated using dimensional regularisation. Tensor integrals arising from the product of tree amplitudes can be reduced to scalar integrals either by using spinor algebra or standard Passarino-Veltman reduction. The remaining scalar integrals have been evaluated previously by van Neerven [54].

At this point, one has obtained the discontinuity, or imaginary part, of the amplitude. However, by making a change of variables the real integration over the  $z$  variable can be cast as a dispersion integral

$$\frac{dz}{z} = \frac{d(\mathbb{P})^2}{\mathbb{P}^2 - P^2} \quad (3.6)$$

that reconstructs the full (cut-constructible part of the) amplitude.



### 3.2 Spinorial Integration

In the BBCFM approach [6, 7], we make a conventional double cut, so that a generic diagram can be written:

$$D = \frac{1}{(2\epsilon)^4} \int^Z \frac{d^4 l_1 d^4 l_2}{l_1^2 l_2^2} \delta^{(4)}(l_1 + l_2 - P) A_L(l_1; P; l_2) A_R(l_2; P; l_1); \quad (3.7)$$

with  $l_1^2 = l_2^2 = 0$ .

The double-cut can be written as,

$$D = \int^Z d\text{LIPS}^{(4)} A_L(l_1; P; l_2) A_R(l_2; P; l_1); \quad (3.8)$$

where the  $d\text{LIPS}^{(4)}$  can be parametrised in spinorial variables, as follows [3],

$$\begin{aligned} \int^Z d\text{LIPS}^{(4)} &= \frac{1}{(2\epsilon)^4} \int^Z d^4 l_1 d^4 l_2 \delta^{(+)}(l_1^2) \delta^{(+)}(l_2^2) \delta^{(4)}(l_1 + l_2 - P) \\ &= \frac{1}{(2\epsilon)^4} \int^Z \frac{h' d' i [d']}{h' j P j'} t dt \delta\left(t - \frac{P^2}{h' j P j'}\right); \end{aligned} \quad (3.9)$$

where the delta function eliminates the integration over  $l_2$ , and the remaining  $l_1$  integration variable has been rescaled,  $l_1 = t'$ , corresponding to,

$$j_{h'} i \frac{P^-}{t} j' i; \quad j_{h'} \frac{P^-}{t} j' \quad (3.10)$$

with  $l_1^2 = l_2^2 = 0$ . Accordingly, the double-cut can be written as,

$$D = \frac{1}{(2\epsilon)^4} \int^Z \frac{h' d' i [d']}{h' j P j'} t dt \delta\left(t - \frac{P^2}{h' j P j'}\right) A_L(t; j' i; j') A_R(t; j' i; j') \quad (3.11)$$

where we indicate only the dependence of the tree-level amplitudes on the integration variables. By means of Schouten identities, one can disentangle the dependence on  $j' i$  and  $j'$ , and express the result of the  $t$ -integration (trivialised by the presence of the  $\delta$ -function) as a combination of terms whose general form looks like,

$$D = \frac{1}{(2\epsilon)^4} \sum_i \int^Z h' d' i [d'] I_i; \quad (3.12)$$

with

$$I_i = \delta_i(j' i) \frac{[d']^n}{h' j P_1 j' j^{n+1} h' j P_2 j'} \quad (3.13)$$

where  $P_1$  and  $P_2$  can either be equal to the cut-momentum  $P$ , or be a linear combination of external vectors; and where the  $\delta_i$ 's depend solely on one spinor flavour, say  $j' i$  (and not on  $j'$ ), and may contain poles in  $j' i$  through factors like  $1 = h' i$  (with  $j' i$  being a massless spinor, either associated to any of the external legs, say  $k_i i$ , or to the action of a

vector on it, like  $\not{k}_i$ ).

The explicit form of the vectors  $P_1$  and  $P_2$  in eq. (3.13) is determining the nature of the double-cut, logarithmic or not, and correspondingly the topology of the diagram which is associated to. Let us distinguish among the two possibilities one encounters, in carrying on the spinor integration of  $I_i$ :

1.  $P_1 = P_2 = P$  (momentum across the cut). In this case, the result is rational, hence containing only the cut of the 2-point function with external momentum  $P$  (or degenerate 3-point functions which can be expressed as combination of 2-point ones).
2.  $P_1 = P, P_2 \notin P$ , or  $P_1 \notin P_2 \notin P$ . In this case, the result is logarithmic, hence containing the cut of a linear combination of  $n$ -point functions with  $n \geq 3$ .

If  $P_1 = P_2 = P$ ,

$$I_i = \int_{\mathcal{C}} \frac{[ \not{j} ]^n}{h' j P j^{\dagger+2}} ; \quad (3.14)$$

If, however,  $P_1 = P, P_2 \notin P$  or  $P_1 \notin P_2 \notin P$ . one proceeds by introducing a Feynman parameter, to write  $I_i$  as,

$$I_i = (n+1) \int_0^1 dx (1-x)^n \int_{\mathcal{C}} \frac{[ \not{j} ]^n}{h' j R j^{\dagger+2}} ; \quad (3.15)$$

with

$$R = x P_1 + (1-x) P_2 ; \quad (3.16)$$

The spinorial structure of eq. (3.14) and eq. (3.15) is the same. Therefore, we proceed with the spinor integration of eq. (3.15) because it is more general than the eq. (3.14), because of the presence of the Feynman parameter.

First, the order of the integrations over the spinor variables and over the Feynman parameter is exchanged and we perform the integration over the  $j$ -variable by parts, using [6]

$$\int_{\mathcal{C}} \frac{[ \not{j} ]^n}{h' j P j^{\dagger+2}} = \frac{[d' \not{R}]}{(n+1) h' j P j^{\dagger+1} h' j P j} \int_{\mathcal{C}} \frac{[ \not{j} ]^{n+1}}{h' j P j} ; \quad (3.17)$$

obtaining,

$$\begin{aligned} D_i &= \frac{1}{(2)^4} \int_{\mathcal{C}} h' d' i [d' \not{R}] I_i = \\ &= \frac{1}{(2)^4} \int_0^1 dx (1-x)^n \int_{\mathcal{C}} h' d' i [d' \not{R}] \frac{\int_{\mathcal{C}} \frac{[ \not{j} ]^{n+1}}{h' j R j^{\dagger+1} h' j R j} ; \end{aligned} \quad (3.18)$$

Afterwards, the integration over the  $j$ -variable is achieved using Cauchy's residues theorem, in the fashion of the holomorphic anomaly [55-57], by taking the residues at  $j = R j$

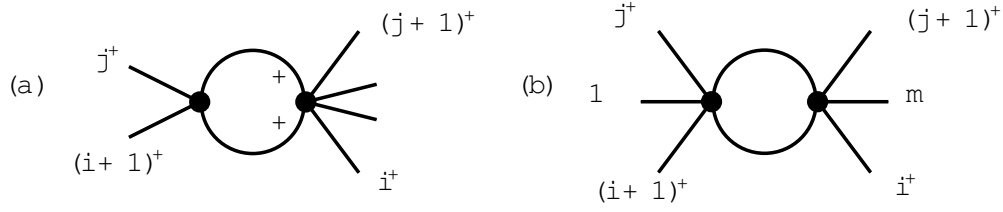

Figure 2: The MHV diagrams contributing to one-loop gluonic MHV amplitudes

and at the simple poles of  $x$ , say  $j^+ = j_{ij}^+$ ,

$$\begin{aligned}
 D_i &= \frac{1}{(2^+)^4} \int_{\mathbb{Z}} h' d^+ i [d^+] I_i = \\
 &= \frac{(2^+)^{\mathbb{Z}-1}}{(2^+)^4} \int_0^{\mathbb{Z}-1} dx (1-x)^n \frac{i(j^+)}{(R^2)^{n+1}} + \sum_j \lim_{j^+ \rightarrow j} h'_{ij} \frac{i(j^+) [j^+]^{n+1}}{h'_{jR} j^{j^+1} h'_{jR} j} : (3.19)
 \end{aligned}$$

To complete the integration of eq. (3.19), one has to perform the parametric integration which is finally responsible for the appearance of logarithmic terms in the double-cut. Alternatively, the spinorial integration of eq. (3.14) would generate a pure rational contribution. We remark that the role of  $j^+$  and  $j^-$  in the integration could be interchanged.

### 3.3 Gluonic amplitudes

We note that there are many similarities between  $n$ -amplitudes and pure glue amplitudes, and we will exploit this by first rederiving the cut-constructible contribution to pure glue MHV amplitudes with the same helicity configuration.

The graphs contributing to the one-loop gluonic amplitude  $A_n^{(1)}(1^+; \dots; m^-; \dots; n^+)$  are shown in Fig. 2. There are two distinct types of diagram, labelled (a) and (b). In type (a), only gluons circulate in the loop, while in type (b) gluons, fermions (and scalars) may circulate. They can be characterised by the following sums

$$\begin{aligned}
 \sum_{i=m}^{\mathbb{Z}-2} \sum_{j=i+2}^{\mathbb{Z}-n} &+ \sum_{i=1}^{\mathbb{Z}-3} \sum_{j=i+2}^{\mathbb{Z}-1} & \text{and} & \sum_{i=n}^{\mathbb{Z}-n} \sum_{j=2}^{\mathbb{Z}-1} &+ \sum_{i=m+1}^{\mathbb{Z}-1} \sum_{j=1}^{\mathbb{Z}-1} &+ \sum_{i=m}^{\mathbb{Z}-n} \sum_{j=1}^{\mathbb{Z}-2} : (3.20)
 \end{aligned}$$

The various contributions have been computed using the MHV rules in Refs. [4, 58, 59]. We note that contributions of type (a) associated with a cut in the  $s_{(j+1),i}$  channel have an integrand of the form,

$$\begin{aligned}
 (A_{LR})_{(j+1),i} &= \frac{h'_{12} i^4}{h'_{1(i+1)} i} \frac{h_{lm} i^4}{2ij h'_{21} i h'_{2(j+1)} i} \frac{h_{lm} i^4}{h_{1i} h'_{12} i} \\
 &= \frac{h_{lm} i^4}{h_{l2i} h_{m1i}} \mathcal{C}(i; i+1; j; j+1) \\
 &A_n^{(0)} \mathcal{C}(i; i+1; j; j+1) \quad (3.21)
 \end{aligned}$$

where

$$\mathcal{P}(i; i+1; j; j+1) = \frac{h'_2 i'_{1i} h i(i+1) i h'_1 i'_{2j} h(j+1) i}{h'_1 i h'_1(i+1) i h j'_2 i h'_2(j+1) i} : \quad (3.22)$$

For diagrams of type (b), there are three possible contributions – depending on whether gluons, fermions (or for supersymmetric theories scalars) are circulating in the loop. It is convenient to consider both (b)-type diagrams in the  $s_{(j+1)i}$  channel together. Immediately, we write down

$$\begin{aligned} (A_L A_R)_{(j+1)i}^{\text{gluons}} &= \frac{h l'_2 i^4 h m'_1 i^4 + h l'_1 i^4 h m'_2 i^4}{h'_1(i+1) i \quad \cancel{h j'_2 i'_{1i} h'_2(j+1) i} \quad \cancel{1 h h'_1 i'_{2i}}} \\ (A_L A_R)_{(j+1)i}^{\text{fermions}} &= \frac{h l'_1 i h l'_2 i^3 h m'_2 i h m'_1 i^3 + h l'_2 i h l'_1 i^3 h m'_1 i h m'_2 i^3}{h'_1(i+1) i \quad \cancel{h j'_2 i'_{1i} h'_2(j+1) i} \quad \cancel{1 h h'_1 i'_{2i}}} \\ (A_L A_R)_{(j+1)i}^{\text{scalars}} &= \frac{h l'_1 i^2 h l'_2 i^2 h m'_2 i^2 h m'_1 i^2}{h'_1(i+1) i \quad \cancel{h j'_2 i'_{1i} h'_2(j+1) i} \quad \cancel{1 h h'_1 i'_{2i}}} \end{aligned} \quad (3.23)$$

In each case, the denominator has the same structure as in the (a)-type diagrams and only the numerator changes with the particle type. We can exploit the Schouten identity

$$h l'_2 i h m'_1 i \quad h l'_1 i h m'_2 i + h l m i h'_1 i'_{2i} = 0 \quad (3.24)$$

to rewrite each of the numerators into a simpler form.

$$\begin{aligned} h l'_2 i^4 h m'_1 i^4 + h l'_1 i^4 h m'_2 i^4 &= h l m i^4 h'_1 i'_{2i}^4 \\ &+ 4 h l'_2 i h m'_1 i h l'_1 i h m'_2 i h l m i^2 h'_1 i'_{2i}^2 \\ &+ 2 h l'_2 i^2 h m'_1 i^2 h l'_1 i^2 h m'_2 i^2 \end{aligned} \quad (3.25)$$

$$\begin{aligned} h l'_1 i h l'_2 i^3 h m'_2 i h m'_1 i^3 + h l'_2 i h l'_1 i^3 h m'_1 i h m'_2 i^3 &= h l'_2 i h m'_1 i h l'_1 i h m'_2 i h l m i^2 h'_1 i'_{2i}^2 \\ &+ 2 h l'_2 i^2 h m'_1 i^2 h l'_1 i^2 h m'_2 i^2 \end{aligned} \quad (3.26)$$

We see that the first term on the RHS of eq. (3.25) corresponds to an (a)-type gluonic contribution which we label with  $G$ , while the third term looks like the scalar contribution of eq. (3.23) which we label with  $S$ . Similarly, the fermion contribution can be separated into a fermionic piece  $F$  and a scalar contribution  $S$ . We define the three contributions as,

$$\begin{aligned} (A_L A_R)_{(j+1)i}^G &= \frac{h l m i^4 h'_1 i'_{2i}^4}{h'_1(i+1) i \quad \cancel{h j'_2 i'_{1i} h'_2(j+1) i} \quad \cancel{1 h h'_1 i'_{2i}}} \\ &= A_n^{(0)} \mathcal{P}(i; i+1; j; j+1) \end{aligned} \quad (3.27)$$

$$\begin{aligned} (A_L A_R)_{(j+1)i}^F &= \frac{h l'_2 i h m'_1 i h l'_1 i h m'_2 i h l m i^2 h'_1 i'_{2i}^2}{h'_1(i+1) i \quad \cancel{h j'_2 i'_{1i} h'_2(j+1) i} \quad \cancel{1 h h'_1 i'_{2i}}} \\ &= A_n^{(0)} \mathcal{F}(i; i+1; j; j+1) \end{aligned} \quad (3.28)$$

$$\begin{aligned} (A_L A_R)_{(j+1)i}^S &= \frac{h l'_1 i^2 h l'_2 i^2 h m'_2 i^2 h m'_1 i^2}{h'_1(i+1) i \quad \cancel{h j'_2 i'_{1i} h'_2(j+1) i} \quad \cancel{1 h h'_1 i'_{2i}}} \\ &= A_n^{(0)} \mathcal{P}(i; i+1; j; j+1) \end{aligned} \quad (3.29)$$

where  $\mathcal{D}(i; i+1; j; j+1)$  is defined in eq. (3.22) and,

$$\mathcal{D}(i; i+1; j; j+1) = \frac{h_i(i+1)ih_j(j+1)ih'_1i'_1ih'_2i'_2ih'_2i'_2i}{h_{lm}i^2hi'_1ih'_1(i+1)ih'_2ih'_2(j+1)i} \quad (3.30)$$

$$\mathcal{D}(i; i+1; j; j+1) = \frac{h_i(i+1)ih_j(j+1)ih'_1i'^2i'_1i'^2ih'_2i'^2ih'_2i'^2i^2}{h_{lm}i^4h'_1i'^2hi'_1ih'_1(i+1)ih'_2ih'_2(j+1)i} \quad (3.31)$$

Restoring the particle multiplicities in supersymmetric theories, we see that for  $N = 4$  SYM with four fermions and six scalars (in the adjoint representation), only the "gluonic" part remains

$$(A_L A_R)_{(j+1)\tilde{i}}^{\text{gluons}} = 4 (A_L A_R)_{(j+1)\tilde{i}}^{\text{fermions}} + 6 (A_L A_R)_{(j+1)\tilde{i}}^{\text{scalars}} = (A_L A_R)_{(j+1)\tilde{i}}^G : \quad (3.32)$$

On the other hand, for QCD with  $N_F$  fermion flavours in the fundamental representation, the contribution from this graph is,

$$(A_L A_R)_{(j+1)\tilde{i}}^{\text{QCD}} = (A_L A_R)_{(j+1)\tilde{i}}^G + 4 \cdot 1 \cdot \frac{N_F}{4N} (A_L A_R)_{(j+1)\tilde{i}}^F + 2 \cdot 1 \cdot \frac{N_F}{N} (A_L A_R)_{(j+1)\tilde{i}}^S : \quad (3.33)$$

The functions  $\mathcal{X}^{\mathcal{D}}$  for  $X = G; F; S$  represent contributions to the cut amplitude. Performing the phase space and dispersion integrals generates the "cut-constructible" contribution to the full amplitude. We define,

$$\mathcal{X}^{\mathcal{D}}(i; i+1; j; j+1) = \int \frac{dz}{z} d^D \text{LIPS}(l_1; l_2; P) \mathcal{X}^{\mathcal{D}}(i; i+1; j; j+1) : \quad (3.34)$$

Explicit expressions for  $\mathcal{X}^{\mathcal{D}}(i; i+1; j; j+1)$  are written down in Appendix A. The one-loop gluonic MHV amplitude is thus obtained by summing combinations of the "cut-constructible" contributions according to eq. (3.20). As a result the one-loop gluonic MHV amplitude is given by,

$$C_{n\tilde{i}}(1; 2^+; \dots; m; \dots; n^+) = c A_n^{(0)} A_{n\tilde{i}}^G(m; n) + 4 \cdot 1 \cdot \frac{N_F}{4N} A_{n\tilde{i}}^F(m; n) + 2 \cdot 1 \cdot \frac{N_F}{N} A_{n\tilde{i}}^S(m; n) \quad (3.35)$$

where

$$A_{n\tilde{i}}^G(m; n) = \frac{1}{2} \sum_{i=1}^{X^n} F_4^{1m}(S_{i\tilde{i}+2}; S_{i\tilde{i}+1}; S_{i+1\tilde{i}+2}) + \frac{1}{4} \sum_{i=1}^{X^n} \sum_{j=i+3}^{X^{i-3}} F_4^{2m}(S_{i;j}; S_{i+1;j-1}; S_{i+1;j}; S_{i;j-1}) : \quad (3.36)$$

The terms associated with the fermion loop have the following form :

$$A_{n\tilde{i}}^F(m; n) = \sum_{i=m+1}^{X^n} \sum_{j=2}^{X^{i-1}} b_{1m}^{ij} F_4^{2m}(S_{i;j}; S_{i-1;j+1}; S_{i-1;j}; S_{i;j+1}) + \sum_{i=2}^{X^{i-1}} \sum_{j=m}^{X^n} \frac{\text{tr}(1; P_{(ij)}; i; m)}{s_{1m}^2} A_{1m}^{ij} T_1(P_{(i+1;j)}; P_{(ij)}) + \sum_{i=2}^{X^n} \sum_{j=m+1}^{X^n} \frac{\text{tr}(1; P_{(ij-1)}; j; m)}{s_{1m}^2} A_{1m}^{j(i-1)} T_1(P_{(ij-1)}; P_{(ij)}) : \quad (3.37)$$

Here we have introduced the shorthand notation

$$\text{tr} (abcd) = \text{habi} [\text{bc}] \text{hcdi} [\text{da}] \quad (3.38)$$

and the auxiliary functions,

$$b_{1m}^{ij} = \frac{\text{tr} (m ; i ; j ; 1) \text{tr} (m ; j ; i ; 1)}{s_{ij}^2 s_{1m}^2} \quad (3.39)$$

$$A_{1m}^{ij} = \frac{\text{tr} (1 ; i ; j ; m)}{s_{ij}} (j ! j + 1) ; \quad (3.40)$$

Note that  $b_{m1}^{ij}$  is symmetric under both  $i \S j$  and  $1 \S m$ , while  $A_{1m}^{ij}$  is antisymmetric under  $1 \S m$ . The function  $F_{4F}^{2m e}$  is the finite pieces of the two mass easy box function (or the finite pieces of the one mass box function in the limit where one of the massive legs becomes massless). We define the triangle function  $T_i(P; Q)$  as,

$$T_i(P; Q) = L_i(P; Q) = \frac{\text{log} (P^2 - Q^2)}{(P^2 - Q^2)^i} \quad P^2 \notin 0; Q^2 \notin 0: \quad (3.41)$$

If one of the invariants becomes massless then the triangle function becomes the divergent function,

$$T_i(P; Q) \rightarrow (-1)^i \frac{1}{(P^2)^i}; \quad Q^2 \rightarrow 0: \quad (3.42)$$

The terms associated with a scalar circulating in the loop have the form,

$$\begin{aligned} A_{n,1}^S(m; n) = & \sum_{i=m+1}^{X^n} \sum_{j=2}^{X^{n-1}} \text{tr} (1; P_{(i,j)}; i; m)^3 A_{1m}^{ij} T_3(P_{(i+1,j)}; P_{(i,j)}) \\ & + \sum_{i=2}^{X^{n-1}} \sum_{j=m}^{X^n} \frac{\text{tr} (1; P_{(i,j)}; i; m)^2}{2s_{1m}^4} K_{1m}^{ij} T_2(P_{(i+1,j)}; P_{(i,j)}) \\ & + \sum_{i=2}^{X^{n-1}} \sum_{j=m}^{X^n} \frac{\text{tr} (1; P_{(i,j)}; i; m)}{s_{1m}^4} I_{1m}^{ij} T_1(P_{(i+1,j)}; P_{(i,j)}) \\ & + \sum_{i=2}^{X^n} \sum_{j=m+1}^{X^n} \frac{\text{tr} (1; P_{(i,j-1)}; j; m)^3}{3s_{1m}^4} A_{1m}^{j(i-1)} T_3(P_{(i,j-1)}; P_{(i,j)}) \\ & + \sum_{i=2}^{X^n} \sum_{j=m+1}^{X^n} \frac{\text{tr} (1; P_{(i,j-1)}; j; m)^2}{2s_{1m}^4} K_{1m}^{j(i-1)} T_2(P_{(i,j-1)}; P_{(i,j)}) \\ & + \sum_{i=2}^{X^n} \sum_{j=m+1}^{X^n} \frac{\text{tr} (1; P_{(i,j-1)}; j; m)}{s_{1m}^4} I_{1m}^{j(i-1)} T_1(P_{(i,j-1)}; P_{(i,j)}) : \quad (3.43) \end{aligned}$$

Here we have introduced two further auxiliary functions which are defined as follows,

$$K_{1m}^{ij} = \frac{\text{tr} (1; i; j; m)^2}{s_{ij}^2} (j ! j + 1) ; \quad (3.44)$$

$$I_{1m}^{ij} = \frac{\text{tr} (1; i; j; m)^2 \text{tr} (1; j; i; m)}{s_{ij}^3} (j ! j + 1) : \quad (3.45)$$

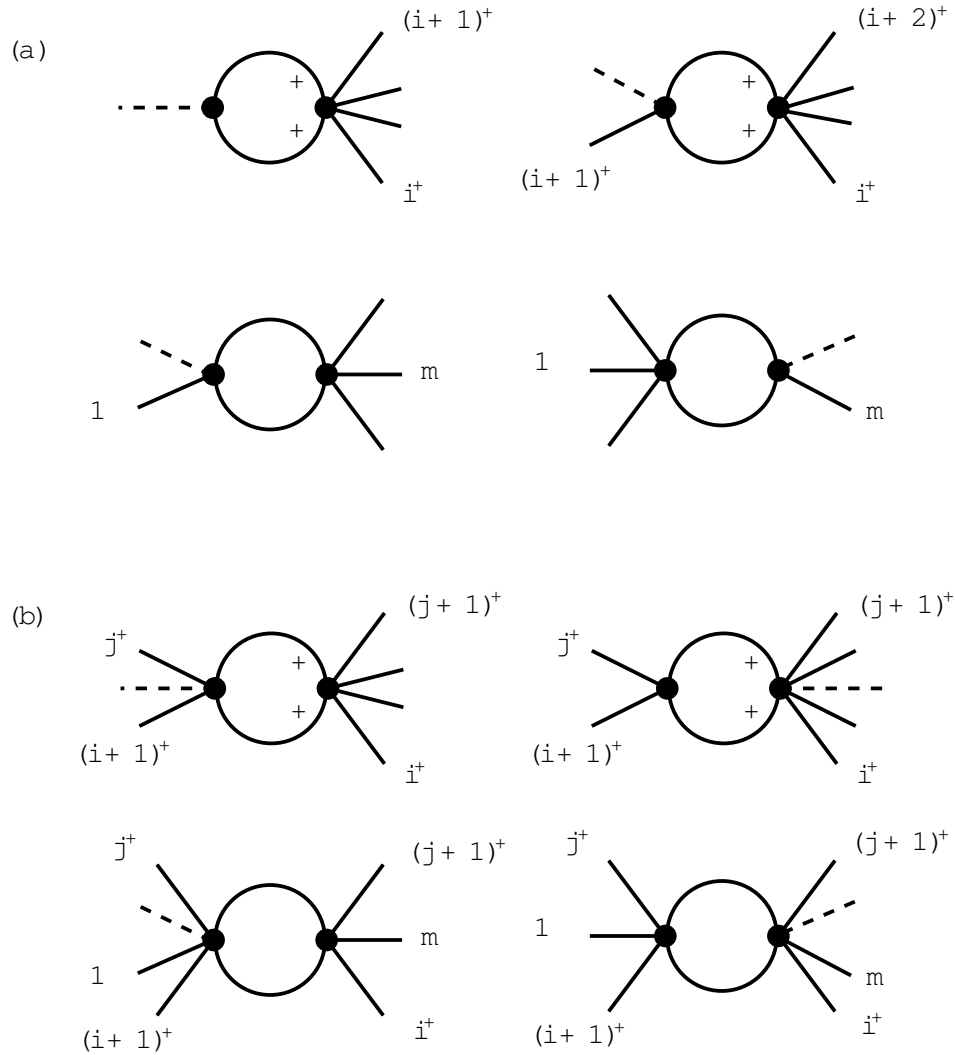

Figure 3: The MHV diagrams contributing to one-loop MHV amplitudes.

### 3.4 MHV amplitudes

The graphs contributing to one-loop MHV amplitudes are shown in Fig. 3. Diagrams of type (b) are the QCD graphs dressed with an additional  $\gamma$ , which may couple at either the left or right vertex. The presence of the  $\gamma$  does not alter the spinor structure of the amplitudes, so these graphs are exactly those for the pure-QCD amplitudes of the previous section, modified to account for the momentum carried by the  $\gamma$ . The ranges of summations correspond to those given in eq. (3.20).

On the other hand, the diagrams shown in Fig. 3(a) have no counterpart in pure-QCD. They all vanish in the limit where the four-momentum of the  $\gamma$  vanishes. The diagram

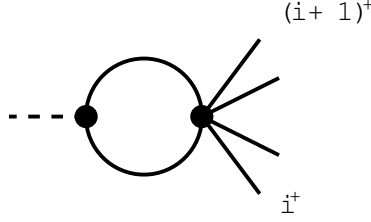

Figure 4: A one-loop diagram in the  $s_{i+1,i}$  channel

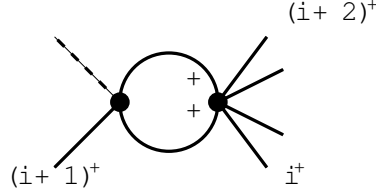

Figure 5: A one-loop diagram in the  $s_{i+2,i}$  channel

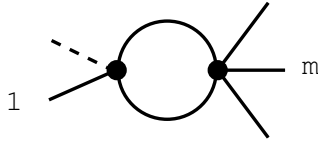

Figure 6: A one-loop diagram in the  $s_{2,m}$  channel

contributing to a cut in the  $s_{i+1,i}$  channel is shown in Fig. 4.

$$\begin{aligned}
 (A_L A_R)_{1,n} &= \frac{h'_1 h'_2 i^2 h l m i^4}{h'_2 (i+1) i} = A_n^{(0)} \frac{h i (i+1) i h'_1 h'_2 i}{h'_2 (i+1) i h i'_1 i} \\
 &= A_n^{(0)} (1 + G(i; i+1))
 \end{aligned} \tag{3.46}$$

with  $G(i; j)$  defined in eq. (A.2). The diagram contributing to a cut in the  $s_{i+2,i}$  channel is shown in Fig. 5.

$$\begin{aligned}
 (A_L A_R)_{i+2,i} &= \frac{h'_1 h'_2 i^4 h l m i^4}{h'_1 (i+1) i h (i+1) h'_2 i h'_1 h'_2 (i+2) i} \\
 &= A_n^{(0)} \Phi(i; i+1; i+1; i+2):
 \end{aligned} \tag{3.47}$$

The diagram contributing to a cut in the  $s_{2,m}$  channel is shown in Fig. 6. There are contributions from both gluon and fermion loops, and we find,

$$(A_L A_R)_{2,m}^{QCD} = A_n^{(0)} \left[ \Phi(n; 1; 1; 2) - \frac{N_F}{4N} \Phi(n; 1; 1; 2) + \frac{N_F}{N} \Phi(n; 1; 1; 2) \right] : \tag{3.48}$$

The diagram contributing to a cut in the  $s_{m+1,m-1}$  channel is shown in Fig. 7. There are



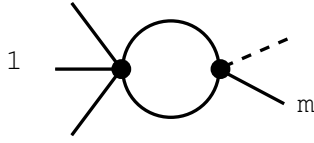

Figure 7: A one-loop diagram in the  $s_{m+1, m-1}$  channel

contributions from both gluon and fermion loops, and we find,

$$\begin{aligned}
 (A_L A_R)_{m+1, m-1}^{\text{QCD}} &= A_n^{(0)} \mathcal{P}(m; m+1; m-1; m) \left[ 4 - 1 - \frac{N_F}{4N} \right] \mathcal{P}(m; m+1; m-1; m) \\
 &+ 2 - 1 - \frac{N_F}{N} \mathcal{P}(m; m+1; m-1; m) : \quad (3.49)
 \end{aligned}$$

Combining all of the diagrams together we find that the cut-constructible pieces of the general  $M$  HV amplitude is given by,

$$\begin{aligned}
 C_{n, \lambda}(\lambda_1; 2^+; \dots; m^-; \dots; n^+) \\
 = c A_n^{(0)} A_{n, \lambda}^G(m; n) \left[ 4 - 1 - \frac{N_F}{4N} \right] A_{n, \lambda}^F(m; n) + 2 - 1 - \frac{N_F}{N} A_{n, \lambda}^S(m; n) ; \quad (3.50)
 \end{aligned}$$

where

$$\begin{aligned}
 A_{n, \lambda}^G(m; n) &= \frac{1}{2} \sum_{i=1}^n \sum_{j=i+3}^{n-1} F_4^{2m, e}(s_{ij}; s_{i+1, j-1}; s_{i+1, j}; s_{ij-1}) + \frac{1}{2} \sum_{i=1}^n F_4^{1m}(s_{i, i+2}; s_{i, i+1}; s_{i+1, i+2}) \\
 &+ \sum_{i=1}^n (F_3^{1m}(s_{i, n+i-2}) - F_3^{1m}(s_{i, n+i-1})): \quad (3.51)
 \end{aligned}$$

We notice that  $A_{n, \lambda}^G(m; n)$  is independent of the position of the two negative helicity gluons; this is exactly as one would expect from an  $N = 4$  theory. Nevertheless, the presence of the colourless scalar has removed the supersymmetry and as a result we see the appearance

of  $F_3^{1m}$  functions which are not present in eq. (3.36). We can write the fermionic pieces as,

$$\begin{aligned}
A_{n,i}^F(m;n) = & \sum_{i=2}^{X-1} \sum_{j=m+1}^{X^n} b_{1m}^{ij} F_{4F}^{2m} e(S_{i,j}; S_{i+1,j-1}; S_{i+1,j}; S_{i,j-1}) \\
& + \sum_{i=2}^{X-1} \sum_{j=m+1}^{X^n} b_{1m}^{ij} F_{4F}^{2m} e(S_{j,i}; S_{j+1,i-1}; S_{j+1,i}; S_{j,i-1}) \\
& + \sum_{i=2}^{X-1} \sum_{j=m}^{X^n} \frac{\text{tr}(m; P_{(i,j)}; i; 1)}{S_{1m}^2} A_{m-1}^{ij} L_1(P_{(i+1,j)}; P_{(i,j)}) \\
& + \sum_{i=2}^{X-1} \sum_{j=m+1}^{X^1} \frac{\text{tr}(1; P_{(j,i)}; i; m)}{S_{1m}^2} A_{1m}^{i(j-1)} L_1(P_{(j,i-1)}; P_{(j,i)}) \\
& + \sum_{i=2}^{X^n} \sum_{j=m+1}^{X^n} \frac{\text{tr}(m; P_{(i,j)}; j; 1)}{S_{1m}^2} A_{m-1}^{j(i-1)} L_1(P_{(i,j-1)}; P_{(i,j)}) \\
& + \sum_{i=1}^{X-1} \sum_{j=m+1}^{X^n} \frac{\text{tr}(1; P_{(j,i)}; j; m)}{S_{1m}^2} A_{1m}^{ji} L_1(P_{(j+1,i)}; P_{(j,i)}) \tag{3.52}
\end{aligned}$$

where the functions  $b_{m-1}^{ij}$  and  $A_{m-1}^{ij}$  are the same auxiliary functions as in the pure-gluon case and are given by eqs. (3.39) and (3.40) respectively.

Finally the scalar pieces are given by,

$$\begin{aligned}
A_{n;l}^S(m;n) = & \sum_{i=2}^{n-1} \sum_{j=m+1}^n (b_{1m}^{ij})^2 F_{4F}^{2m} e(s_{i,j}; s_{i+1,j-1}; s_{i+1,j}; s_{i,j-1}) \\
& \sum_{i=m+1}^n \sum_{j=2}^{n-1} (b_{1m}^{ij})^2 F_{4F}^{2m} e(s_{i,j}; s_{i+1,j-1}; s_{i+1,j}; s_{i,j-1}) \\
& + \sum_{i=2}^{n-1} \sum_{j=m}^{n-1} \frac{\text{tr}(m; P_{(i,j)}; i; 1)^3}{3s_{1m}^4} A_{m-1}^{ij} L_3(P_{(i+1,j)}; P_{(i,j)}) \\
& \quad + \frac{\text{tr}(m; P_{(i,j)}; i; 1)^2}{2s_{1m}^4} K_{m-1}^{ij} L_2(P_{(i+1,j)}; P_{(i,j)}) \quad \# \\
& \quad + \frac{\text{tr}(m; P_{(i,j)}; i; 1)}{s_{1m}^4} I_{m-1}^{ij} L_1(P_{(i+1,j)}; P_{(i,j)}) \\
& + \sum_{i=1}^{n-1} \sum_{j=m+1}^n \frac{\text{tr}(1; P_{(j,i)}; j; m)^3}{3s_{1m}^4} A_{1m}^{ji} L_3(P_{(j+1,i)}; P_{(j,i)}) \\
& \quad + \frac{\text{tr}(1; P_{(j,i)}; j; m)^2}{2s_{1m}^4} K_{1m}^{ji} L_2(P_{(j+1,i)}; P_{(j,i)}) \quad \# \\
& \quad + \frac{\text{tr}(1; P_{(j,i)}; j; m)}{s_{1m}^4} I_{1m}^{ji} L_1(P_{(j+1,i)}; P_{(j,i)}) \\
& + \sum_{i=2}^n \sum_{j=m+1}^{n-1} \frac{\text{tr}(m; P_{(i,j)}; j; 1)^3}{3s_{1m}^4} A_{m-1}^{j(i-1)} L_3(P_{(i,j-1)}; P_{(i,j)}) \\
& \quad + \frac{\text{tr}(m; P_{(i,j)}; j; 1)^2}{2s_{1m}^4} K_{m-1}^{j(i-1)} L_2(P_{(i,j-1)}; P_{(i,j)}) \quad \# \\
& \quad + \frac{\text{tr}(m; P_{(i,j)}; j; 1)}{s_{1m}^4} I_{m-1}^{j(i-1)} L_1(P_{(i,j-1)}; P_{(i,j)}) \\
& + \sum_{i=2}^{n-1} \sum_{j=m+1}^{n-1} \frac{\text{tr}(1; P_{(j,i)}; i; m)^3}{3s_{1m}^4} A_{1m}^{i(j-1)} L_3(P_{(j,i-1)}; P_{(j,i)}) \\
& \quad + \frac{\text{tr}(1; P_{(j,i)}; i; m)^2}{2s_{1m}^4} K_{1m}^{i(j-1)} L_2(P_{(j,i-1)}; P_{(j,i)}) \quad \# \\
& \quad + \frac{\text{tr}(1; P_{(j,i)}; i; m)}{s_{1m}^4} I_{1m}^{i(j-1)} L_1(P_{(j,i-1)}; P_{(j,i)}) \quad (3.53)
\end{aligned}$$

where the auxiliary functions  $K_{m-1}^{ij}$  and  $I_{m-1}^{ij}$  are the same as in the pure-gluon case and are given by eqs. (3.44) and (3.45) respectively.

The similarities and differences between the gluonic MHV and the  $\mathcal{N}=4$  MHV calculation are now most obvious. It is clear that both have the same type of auxiliary functions multiplying the one-loop basis functions, however the presence of the scalar has introduced a second set of summations. One difference is that in the  $\mathcal{N}=4$  MHV result there are no

degenerate triangles. This is a consequence of the absence of  $O(s^{-1})$  terms as predicted by the infrared pole structure.

### 3.5 Cross Check: The adjacent minus amplitude

The one-loop  $(s; 1; 2; \dots; n^+)$  amplitude has been calculated [20] and provides a check of our calculation. As mentioned earlier  $A_{n,1}^G$  is independent of  $m$  so we only need explicitly check the remaining two contributions, which collapse to,

$$A_{n,1}^F(2;n) = \sum_{i=3}^{X^n} \frac{\text{tr}(1; P_{(i+1;n)}; i; 2)}{s_{12}} L_1(P_{(i+1;n)}; P_{(i,1)}) + \sum_{i=4}^{X^n} \frac{\text{tr}(2; P_{(3;n-1)}; i; 1)}{s_{12}} L_1(P_{(2;n-1)}; P_{(2;n)}); \quad (3.54)$$

and

$$A_{n,1}^S(2;n) = \sum_{i=4}^{X^n} \frac{\text{tr}(2; P_{(3;n-1)}; i; 1)^3}{3s_{12}^3} L_3(P_{(2;n-1)}; P_{(2;n)}) + \frac{\text{tr}(2; P_{(3;n-1)}; i; 1)^2}{2s_{12}^2} L_2(P_{(2;n-1)}; P_{(2;n)}) + \sum_{i=3}^{X^{n-1}} \frac{\text{tr}(1; P_{(i+1;n)}; i; 2)^3}{3s_{12}^3} L_3(P_{(i+1;n)}; P_{(i,1)}) + \frac{\text{tr}(1; P_{(i+1;n)}; i; 2)^2}{2s_{12}^2} L_2(P_{(i+1;n)}; P_{(i,1)}); \quad (3.55)$$

respectively, and which is in agreement with the result of [20].

### 3.6 Cut-completion Terms

The basis-set of logarithmic functions in which the results are expressed contains unphysical singularities, which we remove by adding in rational pieces, the so-called cut completion terms. The new basis is given by the transformation,

$$\begin{aligned} L_1(s;t) &= \hat{L}_1(s;t); \\ L_2(s;t) &= \hat{L}_2(s;t) + \frac{1}{2(s-t)} \left( \frac{1}{t} + \frac{1}{s} \right); \\ L_3(s;t) &= \hat{L}_3(s;t) + \frac{1}{2(s-t)^2} \left( \frac{1}{t} + \frac{1}{s} \right); \end{aligned} \quad (3.56)$$

From the breakdown of our amplitude it is clear that only the scalar pieces contribute. When considering the overlap terms in the next section it proves most convenient to write

the cut-completion terms in the following form ,

$$\begin{aligned}
C R_n ( ; 1 ; \dots ; m ; \dots ; n^+ ) = & \quad n \\
\mathbb{X}^n \quad \mathbb{X}^n & \quad \sum_{i=2}^{j-1} \sum_{j=m+1}^n (P_{(i,j-1)}) \frac{1}{S_{i,j-1}} + \frac{1}{S_{i,j}} \quad \mathbb{X}^{-1} \mathbb{X}^n \quad \sum_{i=2}^{j-1} \sum_{j=m}^n (P_{(i+1,j)}) \frac{1}{S_{i+1,j}} + \frac{1}{S_{i,j}} \\
+ \quad \mathbb{X}^{-1} \mathbb{X}^{+1} & \quad \sum_{i=2}^{j-1} \sum_{j=m+1}^n (P_{(j,i-1)}) \frac{1}{S_{j,i-1}} + \frac{1}{S_{j,i}} \quad \mathbb{X}^{-1} \mathbb{X}^n \quad \sum_{i=1}^{j-1} \sum_{j=m+1}^n (P_{(j+1,i)}) \frac{1}{S_{j+1,i}} + \frac{1}{S_{j,i}} \quad ;
\end{aligned} \tag{3.57}$$

The factor  $n$  is given by,

$$n = \frac{c N_P}{2 \sum_{i=1}^n h_i + 1i} ; \tag{3.58}$$

and

$$a_{m-1}^{ab} (P_{(i,j)}) = \frac{m j P_{(i,j)} a j l^3}{3 a \mathcal{P}_{(i,j)} j a^2} A_{m-1}^{ab} + \frac{m \mathcal{P}_{(i,j)} a j l^2}{2 a \mathcal{P}_{(i,j)} j a} K_{m-1}^{ab} ; \tag{3.59}$$

with

$$A_{m-1}^{ab} = \frac{h m a i h b l i}{h a b i} \quad (b! \quad b+1) ; \tag{3.60}$$

$$K_{m-1}^{ab} = \frac{h m a i^2 h b l i^2}{h a b i^2} \quad (b! \quad b+1) ; \tag{3.61}$$

We have also introduced the short-hand notation ,

$$N_P = 2 \quad 1 \quad \frac{N_F}{N_c} \quad ; \tag{3.62}$$

#### 4. The Rational Pieces

In addition to the cut-constructible terms calculated in the previous section, one-loop amplitudes in non-supersymmetric theories also contain rational terms with no discontinuities. By definition this means that these terms can only contain simple poles in physical invariants, which makes these terms amenable to the BCFW recursion relation techniques. So far successful applications have included amplitudes in QCD [14{16] and the finite and adjacent minus amplitudes [50].

In an earlier section, we cancelled unphysical poles in  $C_n$  by introducing the cut-completion terms  $C R_n$ . If we naively set up the recursion relations we would double count on these rational pieces. To avoid this, we define the recursion relation as a function of the

physical poles  $\hat{R}_n = R_n - CR_n$ . We make a complex shift of the two negative gluons such that

$$\hat{j}_i = j_i + z j_n; \quad \hat{j}_m = j_m - z j_l; \quad (4.1)$$

ensuring that overall momentum is conserved since

$$p_1(z) = p_1 + \frac{z}{2} (m_j - j_l); \quad p_m(z) = p_m - \frac{z}{2} (m_j - j_l); \quad (4.2)$$

The recursion relation on  $\hat{R}_n$  is defined through the following integral,

$$\frac{1}{2} \int_{i_c}^I \frac{dz}{z} \hat{R}_n = \frac{1}{2} \int_{i_c}^I \frac{dz}{z} (R_n - CR_n); \quad (4.3)$$

Provided that  $z$  is chosen such that  $A(z) \neq 0$  as  $z$  goes to infinity, the integral vanishes. The residues of the integrand are fixed by multiparticle factorisation so that the rational pieces are given by:

$$\begin{aligned} \hat{R}_n(0) &= \sum_{\text{phys poles } z_i} \text{Res}_{z=z_i} \frac{(R_n(z) - CR_n(z))}{z} \\ &= \sum_i \frac{A_L^{(0)}(z)R_R(z) + R_L(z)A_R^{(0)}(z)}{P_i^2} + \sum_i \text{Res}_{z=z_i} \frac{CR_n(z)}{z}; \end{aligned} \quad (4.4)$$

The final piece of this equation is called the overlap term. Its calculation is relatively simple if the poles are all first order.

#### 4.1 Recursive terms

The direct recursive terms are obtained by using the following formula

$$R_n^D = \sum_i \frac{A_L^{(0)}(z)R_R(z) + R_L(z)A_R^{(0)}(z)}{P_i^2}; \quad (4.5)$$

For our chosen shift (4.1), the allowed diagrams are shown in Fig. 8, and the summation over these given by eq. (4.11). In the sum  $R$  is defined as the full rational part of the amplitude with fewer than  $n$  external legs. Due to our choice of shifts the tree amplitudes

$$A^{(0)}(j^+; \hat{1}^-; P_{(1;j)}^-); \quad A^{(0)}(j^+; \hat{m}^-; P_{(m;j)}^+)$$

are both zero, (here  $j \geq 2; n; (m-1)g$ ). These three point amplitudes are hence not included in either the diagram or the sum. Other terms that vanish are  $R_2(-; +)$  which is required to be zero by angular momentum conservation, and  $R(j^+; \hat{m}^-; \hat{P}^+)$  since the corresponding splitting function has no rational pieces.

Because the tree amplitudes with fewer than two negative helicities vanish, the one requires the one-loop contributions with one negative helicity. These are finite one-loop amplitudes and are entirely rational. The finite  $++\dots+$  amplitudes were computed

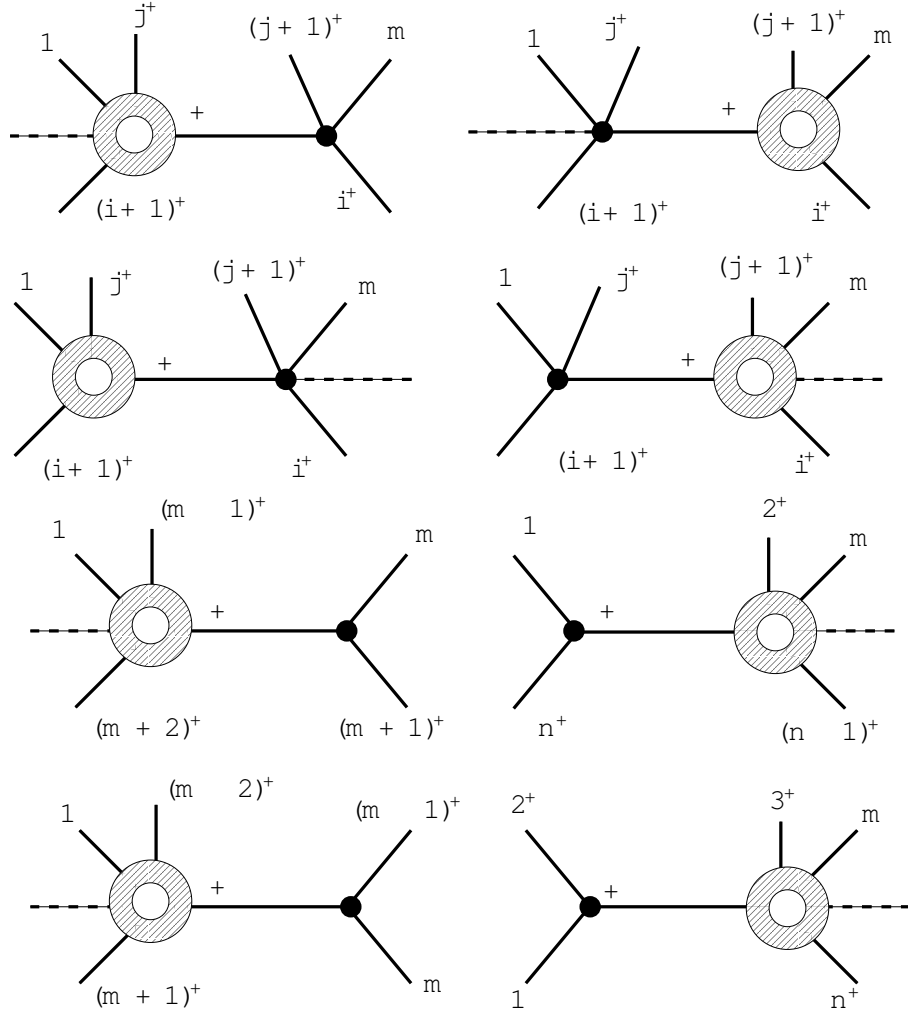

Figure 8: The direct recursive terms contributing to  $R_n(\dots; 1^+; \dots; m^+; \dots; n^+)$

for arbitrary numbers of positive helicity gluons in ref. [50]. As a concrete example, the three-gluon amplitude is given by,

$$R_3(\dots; 1^+; 2^+; 3^+) = \frac{N_P}{96} \frac{h[2,3,1]}{h[2,3]^2} = \frac{1}{8} A_3^{(0)}(\dots; 1^+; 2^+; 3^+); \quad (4.6)$$

Similarly, the pure QCD  $+\dots+$  amplitudes are given to all orders in ref. [14, 60]. In the four-gluon case, the result is,

$$R_4(1^+; 2^+; 3^+; 4^+) = \frac{N_P}{96} \frac{h[2,4]^3}{[1,2]h[2,3]h[3,4]h[4,1]} \quad (4.7)$$

Finally, there are the "homogenous" terms in the recursion which depend on the MHV

amplitude with one gluon fewer. The first few MHV amplitudes are known,

$$R_2(\hat{1}; 2^-) = \frac{1}{8} A^{(0)}(\hat{1}; 2^-); \quad (4.8)$$

$$R_3(\hat{1}; 2^-; 3^+) = \frac{1}{8} A^{(0)}(\hat{1}; 2^-; 3^+); \quad (4.9)$$

$$R_3(\hat{1}; 2^+; 3^-) = \frac{1}{8} A^{(0)}(\hat{1}; 2^+; 3^-); \quad (4.10)$$

Combining the various diagrams, we find that recursive terms obey the following relation,

$$\begin{aligned} R_n^D(\hat{1}; \dots; m^-; \dots; n^+) = & \\ & \sum_{i=m}^{X^n} \sum_{j=1}^{X^{n-1}} R(\hat{1}; \dots; j^+; \hat{P}_{(j+1,i)}^+; (i+1)^+) \frac{1}{S_{j+1,i}} A^{(0)}(\hat{P}_{(j+1,i)}^+; (j+1)^+; \dots; m^-; \dots; i^+) \\ & + \sum_{j=1}^{X^{n-1}} \sum_{i=m}^{X^n} A^{(0)}(\hat{1}; \dots; j^+; \hat{P}_{(j+1,i)}^+; (i+1)^+) \frac{1}{S_{j+1,i}} R(\hat{P}_{(j+1,i)}^+; (j+1)^+; \dots; m^-; \dots; i^+) \\ & + \sum_{j=1}^{X^{n-1}} \sum_{i=m}^{X^n} R(\hat{1}; \dots; j^+; \hat{P}_{(i+1,j)}^+; (i+1)^+) \frac{1}{S_{i+1,j}} A^{(0)}(\hat{P}_{(i+1,j)}^+; (j+1)^+; \dots; m^-; \dots; i^+) \\ & + \sum_{j=1}^{X^{n-1}} \sum_{i=m}^{X^n} A^{(0)}(\hat{1}; \dots; j^+; \hat{P}_{(i+1,j)}^+; (i+1)^+) \frac{1}{S_{i+1,j}} R(\hat{P}_{(i+1,j)}^+; (j+1)^+; \dots; m^-; \dots; i^+) \\ & + R(\hat{1}; \dots; (m-1)^+; \hat{P}_{(m,m+1)}^+; (m+2)^+) \frac{1}{S_{m,m+1}} A^{(0)}(\hat{P}_{(m,m+1)}^+; m^-; (m+1)^+) \\ & + R(\hat{1}; \dots; (m-2)^+; \hat{P}_{(m-1,m)}^+; (m+1)^+) \frac{1}{S_{m-1,m}} A^{(0)}(\hat{P}_{(m-1,m)}^+; (m-1)^+; m^-) \\ & + A^{(0)}(\hat{1}; \hat{P}_{(n,1)}^+; n^+) \frac{1}{S_{n,1}} R(\hat{P}_{(n,1)}^+; 2^+; \dots; m^-; \dots; (n-1)^+) \\ & + A^{(0)}(\hat{1}; \hat{P}_{(1,2)}^+; 2^+) \frac{1}{S_{1,2}} R(\hat{P}_{(1,2)}^+; 3^+; \dots; m^-; \dots; n^+); \end{aligned} \quad (4.11)$$

The value that  $z$  takes is obtained by requiring that the shifted momenta

$$\hat{p}_{(i,j)}^\pm = P_{(i,j)} \pm \frac{z}{2} [m_j - j]; \quad (4.12)$$

is on-shell. In this equation, the sign is positive when the momentum set  $\{p_i; p_j\}$  includes  $p_1$  and is negative when it includes  $p_m$ . There are six independent channels, each one specified by a particular invariant mass,  $S_{j+1,i}$ ,  $S_{j,i+1}$ , or by the double invariants,  $S_{m,m+1}$ ,  $S_{m-1,m}$ ,  $S_{n,1}$  and  $S_{1,2}$ . In each channel, we find that the value of  $z$  and the hatted variables



are given by,

$$\begin{aligned}
s_{j+1,i} \text{ channels} \quad z_{j+1,i} &= \frac{s_{j+1,i}}{m \mathcal{P}_{(j+1,i)} j 1} \\
\hat{j} i &= \frac{j(p_1 + P_{(j+1,i)}) P_{(j+1,i)} m i}{m \mathcal{P}_{(j+1,i)} j 1}; \quad \hat{j} \hat{n} ] = \frac{j(p_m + P_{(j+1,i)}) P_{(j+1,i)} 1 j}{m \mathcal{P}_{(j+1,i)} j 1}; \\
\hat{P}_{(j+1,i)} &= \frac{\mathcal{P}_{(j+1,i)} 1 j m P_{j+1,i} j}{m \mathcal{P}_{(j+1,i)} j 1} \\
s_{j,i+1} \text{ channels} \quad z_{j,i+1} &= \frac{s_{j,i+1}}{m \mathcal{P}_{(j,i+1)} j 1} \\
\hat{j} i &= \frac{j(p_1 + P_{(j,i+1)}) P_{(j,i+1)} m i}{m \mathcal{P}_{(j,i+1)} j 1}; \quad \hat{j} \hat{n} ] = \frac{j(p_m + P_{(j,i+1)}) P_{(j,i+1)} 1 j}{m \mathcal{P}_{(j,i+1)} j 1}; \\
\hat{P}_{(j,i+1)} &= \frac{\mathcal{P}_{(j,i+1)} 1 j m P_{(j,i+1)} j}{m \mathcal{P}_{(j,i+1)} j 1} \\
s_{m,m+1} \text{ channel} \quad z_{m,m+1} &= \frac{[(m+1)m]}{[(m+1)1]} \\
\hat{j} i &= \frac{j(p_1 + p_m) m + 1 j}{[1(m+1)]}; \quad \hat{j} \hat{n} ] = j n + 1 \frac{[1m]}{[1(m+1)]}; \quad \hat{P}_{(m,m+1)} = \frac{\mathcal{P}_{(m,m+1)} 1 j m + 1 j}{[(m+1)1]} \\
s_{m-1,m} \text{ channel} \quad z_{m-1,m} &= \frac{[(m-1)m]}{[(m-1)1]} \\
\hat{j} i &= \frac{j(p_1 + p_m) m - 1 j}{[1(m-1)]}; \quad \hat{j} \hat{n} ] = j n - 1 \frac{[1m]}{[1(m-1)]}; \quad \hat{P}_{(m-1,m)} = \frac{\mathcal{P}_{(m-1,m)} 1 j m - 1 j}{[(m-1)1]} \\
s_{n,i} \text{ channel} \quad z_{n,i} &= \frac{h 1 n i}{h m n i} \\
\hat{j} i &= j i \frac{h 1 m i}{h m m i}; \quad \hat{j} \hat{n} ] = \frac{j(p_1 + p_m) n i}{h m n i}; \quad \hat{P}_{(n,i)} = \frac{j i h m P_{(n,i)} j}{h m n i} \\
s_{1,2} \text{ channel} \quad z_{1,2} &= \frac{h 1 2 i}{h m 2 i} \\
\hat{j} i &= j i \frac{h 1 m i}{h 2 m i}; \quad \hat{j} \hat{n} ] = \frac{j(p_1 + p_m) 2 i}{h m 2 i}; \quad \hat{P}_{(1,2)} = \frac{j i h m P_{(1,2)} j}{h m 2 i}
\end{aligned}$$

#### 4.2 The large $z$ behaviour of the completion terms

In order for the direct recursive contribution to correctly generate the rational terms, the shifted amplitude  $A_n^{(1)}(z)$  must vanish as  $z \rightarrow 1$ . With the shift defined in eq. (4.1) acting on two negative helicity gluons this is indeed the case. However, the cut-completion term  $CR_n(z)$  introduced in eq. (3.57) to ensure that the cut constructible part does not have any spurious poles, does not vanish as  $z \rightarrow 1$ . We therefore have to explicitly remove the contribution at infinity from the rational part, which now becomes [18, 19],

$$\hat{R}_n = R_n^D + O_n \quad \text{Inf} CR_n; \quad (4.13)$$

where

$$\text{Inf} CR_n = \lim_{z \rightarrow 1} CR_n(z); \quad (4.14)$$

The calculation of  $\text{InfCR}_n$  is straightforward. For the special case of adjacent negative helicities, corresponding to  $m = 2$ , the cut-completion terms behaves as  $1/z$  as  $z \rightarrow 1$  so that,

$$\text{InfCR}_n(\epsilon_1, \epsilon_2, \dots, \epsilon_n^+) = 0; \quad (4.15)$$

For the general, non-adjacent, case, there is a contribution as  $z \rightarrow 1$  and we find the contribution to be subtracted is,

$$\begin{aligned} \text{InfCR}_n(\epsilon_1, \dots, \epsilon_m, \dots, \epsilon_n^+) &= \frac{c N_P}{2 \ln 2 i \ln m i^{\frac{n-1}{2}} h + 1 i} \\ & \sum_{i=3}^{X^n} \sum_{j=m+1}^{X^n} !^{j,i-1}(P_{(i,j)}) \frac{1}{m \mathcal{P}_{(i,j-1)} j 1} + \frac{1}{m \mathcal{P}_{(i,j)} j 1} \\ & \sum_{i=2}^{X^{1}} \sum_{j=m+1}^{X^n} !^{i,j}(P_{(i,j)}) \frac{1}{m \mathcal{P}_{(i+1,j)} j 1} + \frac{1}{m \mathcal{P}_{(i,j)} j 1} \\ & \sum_{i=2}^{X^{1}} \sum_{j=m+1}^{X^n} !^{j,i}(P_{(i,j)}) \frac{1}{m \mathcal{P}_{(i,j-1)} j 1} + \frac{1}{m \mathcal{P}_{(i,j)} j 1} \\ & + \sum_{i=2}^{X^{1}} \sum_{j=m}^{X^{1}} !^{i,j+1}(P_{(i,j)}) \frac{1}{m \mathcal{P}_{(i+1,j)} j 1} + \frac{1}{m \mathcal{P}_{(i,j)} j 1} \\ & + \sum_{i=2}^{X^{1}} \sum_{j=m+2}^{X^{1+1}} !^{i,j-1}(\mathcal{P}_{(j,i)}) \frac{1}{m \mathcal{P}_{(j,i-1)} j 1} + \frac{1}{m \mathcal{P}_{(j,i)} j 1} \\ & \sum_{i=2}^{X^{1}} \sum_{j=m+1}^{X^n} !^{j,i}(\mathcal{P}_{(j,i)}) \frac{1}{m \mathcal{P}_{(j+1,i)} j 1} + \frac{1}{m \mathcal{P}_{(j,i)} j 1} \\ & \sum_{i=2}^{X^{1}} \sum_{j=m+1}^{X^n} !^{i,j}(\mathcal{P}_{(j,i)}) \frac{1}{m \mathcal{P}_{(j,i-1)} j 1} + \frac{1}{m \mathcal{P}_{(j,i)} j 1} \\ & + \sum_{i=1}^{X^2} \sum_{j=m+1}^{X^n} !^{j,i+1}(\mathcal{P}_{(j,i)}) \frac{1}{m \mathcal{P}_{(j+1,i)} j 1} + \frac{1}{m \mathcal{P}_{(j,i)} j 1} ; \quad (4.16) \end{aligned}$$

with

$$!^{a,b}(P_{(i,j)}) = \frac{m \mathcal{P}_{(i,j)} a j m^2 \text{ham ihbm } i^2}{2 [1 a] \text{ha bi}^2}; \quad (4.17)$$

and  $\mathcal{P}_{(j,i)} = P_{(j,i)} - P_1$ .

### 4.3 Overlap Terms

The overlap terms are defined as [18, 20],

$$O_n = \sum_i^X \text{Res}_{z=z_i} \frac{C R_n(z)}{z}; \quad (4.18)$$

They can be obtained by evaluating the residue of the cut completion term  $CR_n$  given in eq. (3.57) in each of the physical channels. To expose the coefficients of the poles most clearly the cut-completion terms are rewritten as follows,

$$\begin{aligned}
CR_n = & \sum_{i=3}^X \sum_{j=m}^{X-1} \frac{1}{S_{ij}} \left[ \sum_{l=1}^{j-1} P_{(ij)}^{j-l} + \sum_{l=1}^{j+1} P_{(ij)}^{j-l} + P_{(ij)}^{ij} + P_{(ij)}^{i-1j} \right] \\
& + \sum_{i=m+1}^X \sum_{j=2}^{X-1} \frac{1}{S_{ij}} \left[ \sum_{l=1}^{j-1} P_{(ij)}^{j-l} + \sum_{l=1}^{j+1} P_{(ij)}^{j-l} + P_{(ij)}^{ij} + P_{(ij)}^{i-1j} \right] \\
& + \sum_{i=3}^X \frac{1}{S_{in}} \left[ \sum_{l=1}^{n-1} P_{(in)}^{n-l} + P_{(in)}^{in} + P_{(in)}^{i-1n} \right] \\
& + \sum_{i=m+1}^X \frac{1}{S_{i1}} \left[ \sum_{l=1}^{2i-1} P_{(i1)}^{2i-l} + P_{(i1)}^{i1} + P_{(i1)}^{i-11} \right] \\
& + \sum_{j=m}^{X-1} \frac{1}{S_{2j}} \left[ \sum_{l=1}^{j-1} P_{(2j)}^{j-l} + \sum_{l=1}^{j+1} P_{(2j)}^{j-l} + P_{(2j)}^{2j} \right] \\
& + \sum_{j=2}^{X-1} \frac{1}{S_{1j}} \left[ \sum_{l=1}^j P_{(1j)}^{jl} + \sum_{l=1}^{j+1} P_{(1j)}^{jl} + P_{(1j)}^{nj} \right] \\
& + \frac{1}{S_{2n}} \left[ \sum_{l=1}^{n-1} P_{(2n)}^{n-l} + P_{(2n)}^{2n} \right] ; \tag{4.19}
\end{aligned}$$

with  $\mathbb{a}_{lm}^{ab}$  defined in eq. (3.59).

The cut-completion terms contain many different simple poles in  $\mathbb{a}_{ij}$  but only those invariants which contain either  $p_1$  or  $p_m$  (but not both) have non-trivial overlap terms. We observe that the cut completion terms contain only simple residues, so for the  $P_{(ij)}$  pole, the overlap term is given by,

$$O_n^{ij} = CR_n(z_{ij}) \frac{\mathbb{a}_{ij}}{S_{ij}} \tag{4.20}$$

where  $z_{ij}$  is the value of  $z$  that puts  $P_{(ij)}$  on-shell. The multiplicative factor removes the  $\mathbb{a}_{ij}$  pole in  $CR_n$  and replaces it with the correct propagator  $S_{ij}$ .

The cut-completion terms also contribute to the overlap terms because of singularities associated with the multiplicative tree factor in eq. (3.57). The poles in  $h\hat{1}2i$  and  $h\hat{n}1i$  must be treated carefully, but, since the shift leaves  $lmj$  unaltered, there are no overlap terms generated by  $h(m+1)i$  or  $h(m-1)m i$ .

Splitting up the cut-completion terms in this way gives the overlap terms the following structure,

$$\begin{aligned}
O_n = & \sum_{i=3}^X \sum_{j=m}^{X-1} O_{m,n}^{ij} + \sum_{i=m+1}^X \sum_{j=2}^{X-1} O_{1,n}^{ij} + \sum_{i=3}^X O_n^{in} + \sum_{i=m+1}^X O_n^{i1} \\
& + \sum_{j=m}^{X-1} O_n^{2j} + \sum_{j=2}^{X-1} O_n^{1j} + O_n^{2n} + O_n^{12} + O_n^{n1} ; \tag{4.21}
\end{aligned}$$

We now describe in detail the derivation of each of these terms.

#### 4.3.1 The overlap term $O_{m,n}^{ij}$

The first overlap terms we consider are those arising from the  $s_{ij}$  channel when  $3 \leq i \leq m$  and  $m \leq j \leq n-1$ . Since it is always the case that  $p_m \geq P_{(ij)}$ , we use the shift  $z_1 = s_{ij} = m - P_{(ij)}$ . Under this shift the various functions become

$$n(z_1) = \frac{c N_P}{2^{n-1} h} \frac{m P_{(ij)} j!^2}{(p_1 + P_{(ij)}) j!^2 (p_1 + P_{(ij)}) P_{(ij)} j!^m}; \quad (4.22)$$

while,

$$A_{m-1}^{ab}(z_1) = \frac{h m a i^b j (p_1 + P_{(ij)}) P_{(ij)} j!^n}{h a b i^m P_{(ij)} j!} \quad (b! - b + 1)$$

$$K_{m-1}^{ab}(z_1) = \frac{h m a i^{2-b} j (p_1 + P_{(ij)}) P_{(ij)} j!^m}{h a b i^{2-m} P_{(ij)} j!^2} \quad (b! - b + 1) : \quad (4.23)$$

The prefactor multiplying the  $A$  and  $K$  functions is simplified since  $P_{(ij)}$  in the numerator is never shifted (as it is always adjacent to a  $h m j$ ),

$$\frac{h m P_{(ij)} a j!^n}{h a j!^m P_{(ij)} j!^{n-1}} = \frac{m P_{(ij)} j a}{m P_{(ij)} j!} \frac{a j (p_1 + P_{(ij)}) P_{(ij)} j!^n}{a P_{(ij)} j!^{n-1}} : \quad (4.24)$$

$O_{m,n}^{ij}$  is thus given by,

$$O_{m,n}^{ij} = n(z_1) \frac{1}{s_{ij}} \frac{m P_{(ij)} j!}{m P_{(ij)} j!} \frac{j j (p_1 + P_{(ij)}) P_{(ij)} j!^3}{3 j P_{(ij)} j!^2} A_{m-1}^{j(i-1)}(z_1)$$

$$+ \frac{j j (p_1 + P_{(ij)}) P_{(ij)} j!^2}{2 j P_{(ij)} j!} K_{m-1}^{j(i-1)}(z_1) + (j! - j + 1; P_{(ij)}!) P_{(ij)}$$

$$+ \frac{m P_{(ij)} j!}{m P_{(ij)} j!} \frac{i j (p_1 + P_{(ij)}) P_{(ij)} j!^3}{3 i P_{(ij)} j!^2} A_{m-1}^{ij}(z_1)$$

$$+ \frac{i j (p_1 + P_{(ij)}) P_{(ij)} j!^2}{2 i P_{(ij)} j!} K_{m-1}^{ij}(z_1) + (i! - i + 1; P_{(ij)}!) P_{(ij)} : \quad (4.25)$$

#### 4.3.2 The overlap terms $O_n^{in}$ , $O_n^{2j}$ and $O_n^{2n}$

The contributions in the  $s_{in}$ ,  $s_{2j}$  and  $s_{2n}$  channels are evaluated under the same shift as

$O_{m,n}^{ij}$ , such that,

$$\begin{aligned}
O_{m,n}^{i_1 n} &= {}_n(z_1) \frac{1}{s_{i_1 n}} \frac{m \mathcal{P}_{(i_1 n)} j_1}{m \mathcal{P}_{(i_1 n)} j_1} \frac{i_1 j_1 \mathcal{P}_{(i_1 l)} P_{(i_1 n)} j_n^3}{3 i_1 \mathcal{P}_{(i_1 n)} j_1^2} \frac{h m i i n \mathcal{P}_{(i_1 l)} P_{(i_1 n)} j_n}{h i n i m \mathcal{P}_{(i_1 n)} j_1} \\
&\quad + \frac{i \mathcal{P}_{(i_1 l)} P_{(i_1 n)} j_n^2}{2 i \mathcal{P}_{(i_1 n)} j_1} \frac{h m i i^2 n \mathcal{P}_{(i_1 l)} P_{(i_1 n)} j_n^2}{h i n i^2 m \mathcal{P}_{(i_1 n)} j_1^2} + (i! i-1; P_{(i_1 j)}! P_{(i_1 j)}) \\
&\quad + \frac{m \mathcal{P}_{(i_1 n)} j_n}{m \mathcal{P}_{(i_1 n)} j_1} \frac{n \mathcal{P}_{(i_1 l)} P_{(i_1 n)} j_n^3}{3 n \mathcal{P}_{(i_1 n)} j_1^2} A_{m-1}^{n(i-1)}(z_1) + \frac{n \mathcal{P}_{(i_1 l)} P_{(i_1 n)} j_n^2}{2 n \mathcal{P}_{(i_1 n)} j_1} K_{m-1}^{n(i-1)}(z_1) \\
O_{m,n}^{2j} &= {}_n(z_1) \frac{1}{s_{2j}} \frac{m \mathcal{P}_{(2j)} j_2}{m \mathcal{P}_{(2j)} j_1} \frac{j \mathcal{P}_{(1j)} P_{(2j)} j_n^3}{3 j \mathcal{P}_{(2j)} j_1^2} \frac{h m j i 2 \mathcal{P}_{(1j)} P_{(2j)} j_n}{h j 2 i m \mathcal{P}_{(2j)} j_1} \\
&\quad + \frac{j \mathcal{P}_{(1j)} P_{(2j)} j_n^2}{2 j \mathcal{P}_{(2j)} j_1} \frac{h m j i^2 2 \mathcal{P}_{(1j)} P_{(2j)} j_n^2}{h j 2 i^2 m \mathcal{P}_{(2j)} j_1^2} + (j! j+1; P_{(1j)}! P_{(1j)}) \\
&\quad + \frac{m \mathcal{P}_{(2j)} j_2}{m \mathcal{P}_{(2j)} j_1} \frac{2 \mathcal{P}_{(1j)} P_{(2j)} j_n^3}{3 2 \mathcal{P}_{(2j)} j_1^2} A_{m-1}^{2j}(z_1) \frac{2 \mathcal{P}_{(1j)} P_{(2j)} j_n^2}{2 2 \mathcal{P}_{(2j)} j_1} K_{m-1}^{2j}(z_1) ; \\
O_{m,n}^{2n} &= {}_n(z_1) \frac{1}{s_{2n}} \frac{m \mathcal{P}_{(2n)} j_n}{m \mathcal{P}_{(2n)} j_1} \frac{n \mathcal{P}_{(1n)} P_{(2n)} j_n^3}{3 n \mathcal{P}_{(2n)} j_1^2} \frac{h m n i 2 \mathcal{P}_{(1n)} P_{(2n)} j_n}{h 2 n i m \mathcal{P}_{(2n)} j_1} \\
&\quad + \frac{n \mathcal{P}_{(1n)} P_{(2n)} j_n^2}{2 n \mathcal{P}_{(2n)} j_1} \frac{h m n i^2 2 \mathcal{P}_{(1n)} P_{(2n)} j_n^2}{h 2 n i^2 m \mathcal{P}_{(2n)} j_1^2} \\
&\quad + \frac{m \mathcal{P}_{(2n)} j_2}{m \mathcal{P}_{(2n)} j_1} \frac{2 \mathcal{P}_{(1n)} P_{(2n)} j_n^3}{3 2 \mathcal{P}_{(2n)} j_1^2} \frac{h m 2 i n \mathcal{P}_{(1n)} P_{(2n)} j_n}{h 2 n i m \mathcal{P}_{(2n)} j_1} \\
&\quad + \frac{2 \mathcal{P}_{(1n)} P_{(2n)} j_n^2}{2 2 \mathcal{P}_{(2n)} j_1} \frac{h m 2 i^2 n \mathcal{P}_{(1n)} P_{(2n)} j_n^2}{h 2 n i^2 m \mathcal{P}_{(2n)} j_1^2} ; \tag{4.26}
\end{aligned}$$

#### 4.3.3 The overlap terms $O_{1,n}^{ij}$ , $O_n^{1j}$ and $O_n^{il}$

A similar set of overlap terms are generated in the  $s_{i_1 j}$ ,  $s_{1j}$  and  $s_{i_1 l}$  channels when  $p_1 = 2 P_{(i_1 j)}$ . We therefore use the shift  $z_2 = s_{i_1 j} = m \mathcal{P}_{(i_1 j)} j_1$ . Once again the tree factor, and the functions  $A$  and  $K$  must be evaluated under this shift;

$${}_n(z_2) = \frac{c N_P}{2^{n-1} h} \frac{m \mathcal{P}_{(i_1 j)} j_1^2}{(p_1 - P_{(i_1 j)}) j_2^n (p_1 - P_{(i_1 j)}) P_{(i_1 j)} j_n} ; \tag{4.27}$$

with,

$$\begin{aligned}
A_{1m}^{ab}(z_2) &= \frac{h m i m \mathcal{P}_{(i_1 j)} (p_1 - P_{(i_1 j)}) j_a}{h a b i m \mathcal{P}_{(i_1 j)} j_1} (b! b+1) ; \\
K_{1m}^{ab}(z_2) &= \frac{h m i^2 m j P_{(i_1 j)} (p_1 - P_{(i_1 j)}) j_a^2}{h a b i^2 m \mathcal{P}_{(i_1 j)} j_1^2} (b! b+1) ; \tag{4.28}
\end{aligned}$$

Finally the prefactor multiplying the A and K functions is given by,

$$\frac{h_1^j \mathcal{P}_{(i,j)} a_j m i^n}{h_1 \mathcal{P}_{(i,j)} j! P^{-1}} = (1)^n \frac{m \mathcal{P}_{(i,j)} j!}{m \mathcal{P}_{(i,j)} j!} \frac{(P_{(i,j)} - p_1)^{2n} h_1 m i^n}{a \mathcal{P}_{(i,j)} j!^{n-1}} : \quad (4.29)$$

The overlap contributions are given by,

$$\begin{aligned} O_{1n}^{ij} &= {}_n(z_2) \frac{1}{s_{ij}} \frac{m \mathcal{P}_{(i,j)} j!}{m \mathcal{P}_{(i,j)} j!} \frac{(P_{(i,j)} - p_1)^6 h_j m i^3}{3 j \mathcal{P}_{(i,j)} j!^2} A_{1m}^{j(i-1)}(z_2) \\ &+ \frac{(P_{(i,j)} - p_1)^4 h_j m i^2}{2 j \mathcal{P}_{(i,j)} j!} K_{1m}^{j(i-1)}(z_2) + (j! j+1; P_{(i,j)}! P_{(i,j)}) \\ &+ \frac{m \mathcal{P}_{(i,j)} j!}{m \mathcal{P}_{(i,j)} j!} \frac{(P_{(i,j)} - p_1)^6 h_i m i^3}{3 i \mathcal{P}_{(i,j)} j!^2} A_{1m}^{ij}(z_2) \\ &+ \frac{(P_{(i,j)} - p_1)^4 h_i m i^2}{2 i \mathcal{P}_{(i,j)} j!} K_{1m}^{ij}(z_2) + (i! i-1; P_{(i,j)}! P_{(i,j)}) \\ O_n^{1j} &= {}_n(z_2) \frac{1}{s_{1j}} \frac{m \mathcal{P}_{(1,j)} j!}{3 m \mathcal{P}_{(2,j)} j!} \frac{(P_{(2,j)})^6 h_n m i^3}{n \mathcal{P}_{(2,j)} j!^2} A_{1m}^{nj}(z_2) \frac{(P_{(2,j)})^4 h_n m i^2}{2 n \mathcal{P}_{(2,j)} j!} K_{1m}^{nj}(z_2) \\ &+ j! j+1; P_{aj}! P_{aj} \\ &+ \frac{(P_{(2,j)})^6 h_j m i^3}{3 j \mathcal{P}_{(2,j)} j!^2} \frac{h_n m i m j(p_1 - P_{nj}) P_{(1,j)} j!}{h_j n i m \mathcal{P}_{(1,j)} j!} + h_1 m i \\ &+ \frac{(P_{(2,j)})^4 h_j m i^2}{2 j \mathcal{P}_{(2,j)} j!} \frac{h_n m i^2 m j(p_1 - P_{nj}) P_{(1,j)} j!^2}{h_j n i^2 m \mathcal{P}_{(1,j)} j!^2} h_1 m i^2 \\ O_n^{i1} &= {}_n(z_2) \frac{1}{s_{i1}} \frac{m \mathcal{P}_{(i,1)} j!}{m \mathcal{P}_{(i,1)} j!} \frac{(P_{(i,n)})^6 h_i m i^3}{3 i \mathcal{P}_{(i,n)} j!^2} \frac{h_2 m i m \mathcal{P}_{(i,n)} P_{(i,1)} j!}{h_2 i i m \mathcal{P}_{(i,1)} j!} + h_1 m i \\ &+ \frac{(P_{(i,n)})^4 h_i m i^2}{2 i \mathcal{P}_{(i,n)} j!} \frac{h_2 m i^2 m \mathcal{P}_{(i,n)} P_{(i,1)} j!^2}{h_2 i i^2 m \mathcal{P}_{(i,1)} j!^2} + h_1 m i^2 + (i! i-1; P_{ia}! P_{ia}) \\ &+ \frac{m \mathcal{P}_{(i,1)} j!^2}{m \mathcal{P}_{(i,1)} j!} \frac{(P_{(i,n)})^6 h_2 m i^3}{3 \mathcal{P}_{(i,n)} j!^2} A_{1m}^{2(i-1)}(z_4) + \frac{(P_{(i,n)})^4 h_2 m i^2}{2 \mathcal{P}_{(i,n)} j!} K_{1m}^{2(i-1)}(z_4) \end{aligned} \quad (4.30)$$

At first glance there appear to be poles of order greater than one in  $s_2$  and  $s_{n1}$ , however the presence of the factor  $(P_{(i,j)} - p_1)^{2n}$  ensures that when  $i=1; j=2$  or  $i;j=1$  there are no issues with higher poles. As a result, poles in these channels are only generated by the multiplicative tree factor.

#### 4.3.4 The overlap terms $O_n^{1n}$ and $O_n^{12}$

The final two overlap terms have a more subtle origin than the previous contributions and since they come from the tree factor the form of the cut-completion terms, can be

compact. We will however, need to have forms for  $s_{i,j}$  when they acquire a  $z$  dependence (with  $z$  now in either the  $s_{12}$  or  $s_{n1}$  channel). We consider first the  $s_2$  channel ( $z_3 = h_1 2i = h_m 2i$ ), we use the following form for  $s_{i,j}$ , when  $p_m \geq P_{(i,j)}$ :

$$s_{i,j}(z_3) = \frac{m \mathcal{P}_{(i,j)} (P_{(i,j)} + p_1) j^2}{h_m 2i} : \quad (4.31)$$

We will also require the tree factor and the functions  $A$  and  $K$ :

$$n(z_3) = \frac{c N_P}{2^{n-1} h_1 + 1} \frac{h_2 m i}{h_m i h_n 2i h_1 2i} \quad (4.32)$$

$$A_{m1}^{ab}(z_3) = \frac{h_2 2i h_m i h_m a i}{h_2 m i h a b i} \quad (b! - b + 1) \quad (4.33)$$

$$K_{m1}^{ab}(z_3) = \frac{h_2 2i^2 h_m i^2 h_m a i^2}{h_2 m i^2 h a b i^2} \quad (b! - b + 1) \quad (4.34)$$

The overlap terms associated with this channel are defined by using the  $(1 \otimes m)$  symmetry of the cut-completion terms:

$$O_n^{12} = O_{m,n}^{12} + O_{1,n}^{12} \quad (4.35)$$

With  $O_{m,n}^{12}$  defined by,

$$\begin{aligned} O_{m,n}^{12} = & \sum_{i=3}^n \sum_{j=m}^n n(z_3) \frac{m \mathcal{P}_{(i,j)} j j^2 h_1 m i^3}{3 m j (P_{(i,j-1)} + p_1) + P_{(i,j-1)} j j^2} A_{m1}^{j(i-1)}(z_3) \\ & + \frac{m \mathcal{P}_{(i,j)} j j^2 h_1 m i^2}{2 m j (P_{(i,j-1)} + p_1) + P_{(i,j-1)} j j^2} K_{m1}^{j(i-1)}(z_3) \\ & \frac{1}{m \mathcal{P}_{(i,j)} (P_{(i,j)} + p_1) j^2} + \frac{1}{m \mathcal{P}_{(i,j-1)} (P_{(i,j-1)} + p_1) j^2} \\ & + \sum_{i=3}^n \sum_{j=m}^{i-1} \frac{m \mathcal{P}_{(i,j)} i j^2 h_1 m i^3}{3 m j (P_{(i+1,j)} + p_1) + P_{(i+1,j)} i j^2} A_{m1}^{ij}(z_3) \\ & \frac{m \mathcal{P}_{(i,j)} i j^2 h_1 m i^2}{2 m j (P_{(i+1,j)} + p_1) + P_{(i+1,j)} i j^2} K_{m1}^{ij}(z_3) \\ & \frac{1}{m \mathcal{P}_{(i,j)} (P_{(i,j)} + p_1) j^2} + \frac{1}{m \mathcal{P}_{(i+1,j)} (P_{(i+1,j)} + p_1) j^2} \\ & + \sum_{i=3}^n \frac{m \mathcal{P}_{(i,n)} i j^2 h_1 m i^3}{3 m j (P_{(i+1,n)} + P_{(i+1,n)}) i j^2} \frac{h_m i i h_n 2i h_1 m i}{h_i n i h_2 m i} \\ & \frac{m \mathcal{P}_{(i,n)} i j^2 h_1 m i^2}{2 m j (P_{(i+1,n)} + P_{(i+1,n)}) i j^2} \frac{h_m i i^2 h_n 2i^2 h_1 m i^2}{h_i n i^2 h_2 m i^2} \\ & \frac{1}{m \mathcal{P}_{(i,n)} P_{(i,n)} j^2} + \frac{1}{m \mathcal{P}_{(i+1,n)} P_{(i+1,n)} j^2} : \end{aligned} \quad (4.36)$$

For the second set of sums we will need to know  $s_{i,j}$  with  $p_1 \geq P_{(i,j)}$ ,

$$s_{i,j}(z_3) = \frac{m \mathcal{P}_{(i,j)}(P_{(i,j)} - p_1)j^2}{hm^2 i} ; \quad (4.37)$$

We also require,

$$A_{1m}^{ab}(z_3) = \frac{hbm^2 ihlm^2 ai}{h^2 m^2 i h a b i} \quad (b! - b + 1) ; \quad (4.38)$$

$$K_{1m}^{ab}(z_3) = \frac{hbm^2 i^2 hlm^2 i^2 h^2 ai^2}{h^2 m^2 i^2 h a b i^2} \quad (b! - b + 1) ; \quad (4.39)$$

so that,

$$\begin{aligned} O_{1m}^{12} = & \sum_{i=m+1}^n \sum_{j=2}^n (z_3) \frac{2jP_{(i,j)} j^m hlm^3 i^3}{3m^2 j(P_{(i,j)} - p_1) + P_{(i,j)} j^2} A_{1m}^{j(i-1)}(z_3) \\ & + \frac{2jP_{(i,j)} j^m hlm^2 i^2}{2m^2 j(P_{(i,j)} - p_1) + P_{(i,j)} j^2} K_{1m}^{j(i-1)}(z_3) \\ & \frac{1}{m \mathcal{P}_{(i,j)}(P_{(i,j)} - p_1)j^2} + \frac{1}{m \mathcal{P}_{(i,j-1)}(P_{(i,j-1)} - p_1)j^2} \\ & + \sum_{j=2}^n \frac{2jP_{(1,j)} j^m hlm^3 i^3}{3m^2 j(P_{(2,j)} - p_1) + P_{(1,j)} j^2} \frac{h^2 jilm^2 ihlm^2 i}{hjn^2 h^2 m^2 i} + hlm^2 i \\ & + \frac{2jP_{(1,j)} j^m hlm^2 i^2}{2m^2 j(P_{(2,j)} - p_1) + P_{(1,j)} j^2} \frac{h^2 j^2 nm^2 i^2 hlm^2 i^2}{hjn^2 h^2 m^2 i^2} hlm^2 i^2 \\ & \frac{1}{m \mathcal{P}_{(1,j)} P_{(3,j)} j^2} + \frac{1}{m \mathcal{P}_{(2,j-1)} P_{(3,j-1)} j^2} \\ & + \sum_{i=m+1}^n \sum_{j=2}^n \frac{2jP_{(i,j)} j^m hlm^3 i^3}{3m^2 j(P_{(i+1,j)} - p_1) + P_{(i+1,j)} j^2} A_{1m}^{ij}(z_3) \\ & \frac{2jP_{(i,j)} j^m hlm^2 i^2}{2m^2 j(P_{(i+1,j)} - p_1) + P_{(i+1,j)} j^2} K_{1m}^{ij}(z_3) \\ & \frac{1}{m \mathcal{P}_{(i,j)}(P_{(i,j)} - p_1)j^2} + \frac{1}{m \mathcal{P}_{(i+1,j)}(P_{(i+1,j)} - p_1)j^2} : \quad (4.40) \end{aligned}$$

In writing the above, we have used  $A_{m-1}^{11}(z_3) = 0$ .

The final overlap term is  $O_n^{n1}$  and is calculated noting the  $(n \geq 2)$  symmetry in the shift. Once again we define the usual functions under the shift  $(z) = hlni = hlni$ , When  $p_m \geq P_{(i,j)}$ ,

$$s_{i,j}(z_4) = \frac{m \mathcal{P}_{(i,j)}(P_{(i,j)} + p_1)j^n}{hlni} ; \quad (4.41)$$



together with,

$$n(z_4) = \frac{c N_P}{2^{n-1} h} \frac{h n m i}{+ i h l m i h m i h 2 n i}; \quad (4.42)$$

$$A_{m1}^{ab}(z_4) = \frac{h b n i h l m i h m a i}{h n m i h a b i} (b! b+1); \quad (4.43)$$

$$K_{m1}^{ab}(z_4) = \frac{h b n i^2 h l m i^2 h m a i^2}{h n m i^2 h a b i^2} (b! b+1); \quad (4.44)$$

The overlap terms in this channel are again split into two terms

$$O_n^{n1} = O_{m,n}^{n1} + O_{1,n}^{n1}; \quad (4.45)$$

with

$$\begin{aligned} O_{m,n}^{n1} = & \sum_{i=3}^n \sum_{j=m}^{n-1} n(z_4) \frac{m \mathcal{P}_{(i,j)} j j n^3 h l m i^3}{3 m j j (P_{(i,j-1)} + p_1) + P_{(i,j-1)} j j n} {}_2A_{m1}^{j(i-1)}(z_4) \\ & + \frac{m \mathcal{P}_{(i,j)} j j n^2 h l m i^2}{2 m j j (P_{(i,j-1)} + p_1) + P_{(i,j-1)} j j n} K_{m1}^{j(i-1)}(z_4) \\ & \frac{1}{m \mathcal{P}_{(i,j)} (P_{(i,j)} + p_1) j^2} + \frac{1}{m \mathcal{P}_{(i,j-1)} (P_{(i,j-1)} + p_1) j n} \\ & + \sum_{j=m}^{n-1} \frac{m j P_{(2,j)} j j n^3 h l m i^3}{3 m j j P_{(1,j-1)} + P_{(2,j-1)} j j n^2} \frac{h m j i h 2 n i h l m i}{h j 2 i h m i} \\ & \frac{m j P_{(2,j)} j j n^2 h l m i^2}{2 m j j P_{(1,j-1)} + P_{(2,j-1)} j j n} \frac{h m j i^2 h 2 n i^2 h l m i^2}{h j 2 i^2 h n m i^2} \\ & \frac{1}{m \mathcal{P}_{(2,j)} P_{(1,j)} j^2} + \frac{1}{m \mathcal{P}_{(2,j-1)} P_{(1,j-1)} j n} \\ & + \sum_{i=2}^n \sum_{j=m}^{n-1} \frac{m \mathcal{P}_{(i,j)} i j n^3 h l m i^3}{3 m j i (P_{(i+1,j)} + p_1) + P_{(i+1,j)} i j n} {}_2A_{m1}^{ij}(z_4) \\ & \frac{m j P_{(i,j)} i j n^2 h l m i^2}{2 m j i (P_{(i+1,j)} + p_1) + P_{(i+1,j)} i j n} K_{m1}^{ij}(z_3) \\ & \frac{1}{m \mathcal{P}_{(i,j)} (P_{(i,j)} + p_1) j n} + \frac{1}{m \mathcal{P}_{(i+1,j)} (P_{(i+1,j)} + p_1) j n} : \end{aligned} \quad (4.46)$$

For the second set of terms we need to evaluate  $s_{i,j}$  when  $p_1 \geq P_{(i,j)}$ , so that,

$$s_{i,j}(z_4) = \frac{m \mathcal{P}_{(i,j)} (P_{(i,j)} - p_1) j n}{h m n i}; \quad (4.47)$$

and,

$$A_{1m}^{ab}(z_4) = \frac{h b m i h l m i h m a i}{h n m i h a b i} (b! b+1); \quad (4.48)$$

$$K_{1m}^{ab}(z_4) = \frac{h b m i^2 h l m i^2 h m a i^2}{h n m i^2 h a b i^2} (b! b+1); \quad (4.49)$$

We find that,

$$\begin{aligned}
O_{1n}^{n1} = & \sum_{i=m+1}^n \sum_{j=2}^{X^n - X^{i-1}} \frac{X^n - X^{i-1}}{3m \ddot{j}(P_{(i,j)} - p_1) + P_{(i,j)}} \frac{n j P_{(i,j)} j j m^3 h_1 m i^3}{2} A_{1m}^{j(i-1)}(z_4) \\
& + \frac{n j P_{(i,j)} j j m^2 h_1 m i^2}{2m \ddot{j}(P_{(i,j)} - p_1) + P_{(i,j)}} K_{1m}^{j(i-1)}(z_4) \\
& \frac{1}{m \mathcal{P}_{(i,j)}(P_{(i,j)} - p_1) j n} + \frac{1}{m \mathcal{P}_{(i,j-1)}(P_{(i,j-1)} - p_1) j n} \\
& + \sum_{i=m+1}^n \sum_{j=2}^{X^n - X^{i-1}} \frac{X^n - X^{i-1}}{3m \ddot{j}(P_{(i+1,j)} - p_1) + P_{(i+1,j)}} \frac{n \mathcal{P}_{(i,j)} i j m^3 h_1 m i^3}{2} A_{1m}^{ij}(z_4) \\
& \frac{n \mathcal{P}_{(i,j)} i j m^2 h_1 m i^2}{2m \ddot{j}(P_{(i+1,j)} - p_1) + P_{(i+1,j)}} K_{1m}^{ij}(z_4) \\
& \frac{1}{m \mathcal{P}_{(i,j)}(P_{(i,j)} - p_1) j n} + \frac{1}{m \mathcal{P}_{(i+1,j)}(P_{(i+1,j)} - p_1) j n} \\
& + \sum_{i=m+1}^n \frac{X^n}{3m \ddot{j}P_{(i+1,n)} + P_{(i+1,l)}} \frac{n \mathcal{P}_{(i,l)} i j m^3 h_1 m i^3}{2} h_1 m i + \frac{h n i i h_1 m i h_2 m i}{h i 2 i h m m i} \\
& \frac{n \mathcal{P}_{(i,l)} i j m^2 h_1 m i^2}{2m \ddot{j}P_{(i+1,n)} + P_{(i+1,l)}} h_1 m i^2 + \frac{h n i i^2 h_1 m i^2 h_2 m i^2}{h i 2 i^2 h m m i^2} \\
& \frac{1}{m \mathcal{P}_{(i,l)} P_{(i,n)} j n} + \frac{1}{m \mathcal{P}_{(i+1,l)} P_{(i+1,n)} j n} : \tag{4.50}
\end{aligned}$$

## 5. The four point amplitude

The calculation of all Higgs plus four-gluon amplitudes at NLO in the heavy-top effective theory has been performed numerically in [61]. Here we provide an analytic form for the  $A_4^{(1)}(H; 1^-; 2^+; 3^-; 4^+)$  to illustrate the use of our results for the  $-M$  HV amplitude for general  $n$ .

The cut-constructible part of the  $-M$  HV four point amplitude is given by setting  $n = 4$  and  $m = 3$  in eq. (3.50), using the gluonic, fermionic and scalar contributions given

in eqs. (3.51), (3.52) and (3.53) respectively,

$$\begin{aligned}
C_4(\dots) = & A_4^{(0)} \frac{1}{2} X^4 F_4^{2m} e^{(S_{i,i+3}; S_{i+1,i+2}; S_{i+1,i+3}; S_{i,i+2})} \\
& \frac{1}{2} X^4 F_4^{1m} (S_{i,i+2}; S_{i,i+1}; S_{i+1,i+2}) + \frac{1}{2} X^4 (F_3^{1m}(S_{i,2+i}) F_3^{1m}(S_{i,3+i})) \\
& \frac{4}{4N_c} \frac{1}{2} \frac{\text{tr}(3241) \text{tr}(3421)}{s_{24}^2 s_{13}^2} F_{4F}^{1m}(s_{234}; s_{23}; s_{34}) \\
& \frac{\text{tr}(3241) \text{tr}(3421)}{s_{24} s_{13}^2} L_1(s_{23}; s_{234}) + (2 \text{ } \$ \text{ } 4) + (1 \text{ } \$ \text{ } 3) + (1 \text{ } \$ \text{ } 3; 2 \text{ } \$ \text{ } 4) \\
& \frac{2}{N_c} \frac{1}{2} \frac{\text{tr}(3241)^2 \text{tr}(3421)^2}{s_{24}^4 s_{13}^4} F_{4F}^{1m}(s_{234}; s_{23}; s_{34}) \\
& \frac{\text{tr}(3241) \text{tr}(3421)}{s_{13}^4} \frac{\text{tr}(3241)^2}{3s_{24}} L_3(s_{23}; s_{234}) \\
& + \frac{\text{tr}(3241) \text{tr}(3421)}{2s_{24}^2} L_2(s_{23}; s_{234}) + \frac{\text{tr}(3421) \text{tr}(3241)}{s_{24}^3} L_1(s_{23}; s_{234}) \\
& + (2 \text{ } \$ \text{ } 4) + (1 \text{ } \$ \text{ } 3) + (1 \text{ } \$ \text{ } 3; 2 \text{ } \$ \text{ } 4) \quad : \quad (5.1)
\end{aligned}$$

The cut completion terms are given by eq. (3.57),

$$\begin{aligned}
CR_4(\dots) = & \frac{N_P}{32^2} \frac{1}{h_1^2 h_2^3 h_3^4 h_4^1} \\
& \frac{h_3 j_{24} j_{li}^3}{3(s_{234} s_{23})^2} \frac{h_3 h_4 h_2 h_1}{h_4^2 h_2} \frac{h_3 j_{24} j_{li}^2}{2(s_{234} s_{23})} \frac{h_3 h_4 i^2 h_2 h_1^2}{h_4^2 h_2^2} \frac{1}{s_{23}} + \frac{1}{s_{234}} \\
& + (2 \text{ } \$ \text{ } 4) + (1 \text{ } \$ \text{ } 3) + (1 \text{ } \$ \text{ } 3; 2 \text{ } \$ \text{ } 4) : \quad (5.2)
\end{aligned}$$

The remaining rational contributions are obtained by shifting the two negative helicity gluons,

$$\hat{j}_i = j_i + z \beta_i; \quad \hat{\beta}_j = \beta_j - z j_j : \quad (5.3)$$

As discussed in subsection 4.2, this shift generates a non-vanishing contribution as  $z \rightarrow 1$  in the cut completion term  $CR_4$ . To compute this contribution, we use eq. (4.16) with  $m = 3$  and  $n = 4$  to find,

$$\text{Inf} CR_4(\dots) = \frac{N_P}{32^2} \frac{h_2^3 h_3^4 h_4^1 [24]^2}{h_2^4 h_4^2 [12][41]} : \quad (5.4)$$

The direct rational contribution is generated by the recursion relation (4.11), again

with  $m = 3$  and  $n = 4$  and is given by,

$$\begin{aligned}
R_4( ; 1 ; 2^+ ; 3 ; 4^+ ) &= A^{(0)}( ; \hat{1} ; \hat{P}_{234}^+ ) \frac{1}{s_{234}} R( \hat{P}_{234}^+ ; 2^+ ; \hat{3} ; 4^+ ) \\
&+ R( 4^+ ; \hat{1} ; 2^+ ; \hat{P}_{412}^+ ) \frac{1}{s_{412}} A^{(0)}( ; \hat{P}_{412}^+ ; \hat{3} ) \\
&+ R( ; \hat{1} ; 2^+ ; \hat{P}_{34}^+ ) \frac{1}{s_{34}} A^{(0)}( \hat{P}_{34}^+ ; \hat{3} ; 4^+ ) \\
&+ R( ; \hat{1} ; 4^+ ; \hat{P}_{23}^+ ) \frac{1}{s_{23}} A^{(0)}( \hat{P}_{23}^+ ; 2^+ ; \hat{3} ) \\
&+ A^{(0)}( \hat{1} ; \hat{P}_{41}^+ ; 4^+ ) \frac{1}{s_{41}} R( ; \hat{P}_{41}^+ ; 2^+ ; \hat{3} ) \\
&+ A^{(0)}( \hat{1} ; \hat{P}_{12}^+ ; 2^+ ) \frac{1}{s_{12}} R( ; \hat{P}_{12}^+ ; \hat{3} ; 4^+ ); \tag{5.5}
\end{aligned}$$

where we recycle the known lower point amplitudes. For the four-point amplitude, we require the rational parts of the with one minus and two positive helicity gluons (4.6), the two and three-point  $\overline{\text{MHV}}$  amplitudes given in eqs. (4.8), (4.9) and (4.10), as well as the pure four-gluon QCD amplitude with a single negative helicity of eq. (4.7).

We find that

$$R_4^{234} = \frac{N_P}{96^2} \frac{m_H^4}{s_{234}} \frac{h^2 4i [24] h^3 \mathcal{P}_{234} j_1^2}{h^4 \mathcal{P}_{234} j_1^2 h^2 \mathcal{P}_{234} j_1^2}; \tag{5.6}$$

Similarly,

$$\begin{aligned}
R_4^{24} &= \frac{1}{8^2} A^{(0)}( ; y; 4^+ ; 2^+ ; 3 ; 1 ) \frac{N_P}{96^2} s_{123} \frac{[24][21] h^4 \mathcal{P}_{123} j_2^2}{[31][23] h^4 \mathcal{P}_{123} j_1^2}; \\
R_4^{34} &= R_4^{23} \quad (2 \S 4); \tag{5.7}
\end{aligned}$$

In the other channels,

$$\begin{aligned}
R_4^{41} &= \frac{1}{8^2} A^{(0)}( ; 1 ; 3 ; 2^+ ; 4^+ ) \\
R_4^{12} &= R_4^{41} \quad (4 \S 2); \tag{5.8}
\end{aligned}$$

and finally,

$$R_4^{412} = \frac{N_P}{96^2} \frac{[24]^3}{s_{412}} \frac{h^3 \mathcal{P}_{412} j_1^2}{h^2 4i [12]^2 [41]^2}; \tag{5.9}$$

The overlap terms are given by,

$$O_4( ; 1 ; 2^+ ; 3 ; 4^+ ) = O_4^{234} + O_4^{23} + O_4^{34} + O_4^{41} + O_4^{12} + O_4^{412}; \tag{5.10}$$

The first term is generated by eq. (4.26) with  $n = 4$  and has the following form

$$\begin{aligned}
O_4^{234} &= \frac{N_P}{32^2 s_{234}} \frac{1}{3} \frac{h^3 j \mathcal{P}_{234} \mathcal{P}_{1234} j_2^2 [42]}{h^2 4i h^2 \mathcal{P}_{234} j_1^2} \\
&+ \frac{1}{2} \frac{h^3 2i h^3 \mathcal{P}_{234} \mathcal{P}_{1234} j_2 i h^3 \mathcal{P}_{234} \mathcal{P}_{1234} j_4 i [42]}{h^2 4i^2 h^2 \mathcal{P}_{234} j_1 h^3 \mathcal{P}_{234} j_1} + (2 \S 4); \tag{5.11}
\end{aligned}$$

The overlap pieces in the 23 and 34 channels are given by eq. (4.26) and eq. (4.26) (with  $i = j = 3$ ),

$$O_4^{23} = \frac{N_P}{32^2 s_{23}} \frac{h_3 2i^2 h_4 \mathcal{P}_{123} j_2^2 [24]}{3 h_4 \mathcal{P}_{123} j_1^2 h_4 2i} + \frac{h_3 2i h_3 4i [24] h_2 \mathcal{P}_{123} j_2 h_4 \mathcal{P}_{123} j_2]}{2 [12] h_4 2i^2 h_4 \mathcal{P}_{123} j_1} ; \quad (5.12)$$

$$O_4^{34} = O_4^{23} \quad (4 \leftrightarrow 2); \quad (5.13)$$

$O_4^{41}$  and  $O_4^{12}$  both vanish, while eq. (4.30) with  $i = 4; j = 2$  leads to,

$$O_4^{412} = \frac{N_P}{32^2 s_{412}} \frac{1 h_2 3i h_4 3i h_3 \mathcal{P}_{412} j_4 [42]^2}{2 h_2 4i h_3 \mathcal{P}_{412} j_1 [41]} \frac{1 h_2 3i^2 [42]^3}{3 h_2 4i [41]^2} + (2 \leftrightarrow 4) ; \quad (5.14)$$

Combining contributions, the full four-point amplitude is given by,

$$A_4^{(1)}(\gamma; 1^+; 2^+; 3^+; 4^+) = C_4(\gamma; 1^+; 2^+; 3^+; 4^+) + C R_4(\gamma; 1^+; 2^+; 3^+; 4^+) + \hat{R}_4(\gamma; 1^+; 2^+; 3^+; 4^+); \quad (5.15)$$

with

$$\hat{R}_4(\gamma; 1^+; 2^+; 3^+; 4^+) = O_4(\gamma; 1^+; 2^+; 3^+; 4^+) + R_4(\gamma; 1^+; 2^+; 3^+; 4^+) + \text{Inf} C R_4(\gamma; 1^+; 2^+; 3^+; 4^+); \quad (5.16)$$

After some algebra, the combination of overlapping and recursive terms can be written in the following form, free of spurious singularities<sup>1</sup>,

$$\hat{R}_4(\gamma; 1^+; 2^+; 3^+; 4^+) = \frac{1}{8^2} A^{(0)}(A; 1^+; 2^+; 3^+; 4^+) + \frac{N_P}{192^2} \frac{[24]^4}{[12][23][34][41]} \frac{s_{23}s_{34}}{s_{24}s_{412}} + 3 \frac{s_{23}s_{34}}{s_{24}^2} \frac{s_{12}s_{41}}{s_{24}s_{234}} + 3 \frac{s_{12}s_{41}}{s_{24}^2} ; \quad (5.17)$$

where  $A^{(0)}(A; 1^+; 2^+; 3^+; 4^+)$  is the difference of  $\gamma$  and  $\gamma$  amplitudes. Finally the full Higgs amplitude is given by the sum of  $\gamma$  and  $\gamma$  amplitudes

$$A_4^{(1)}(H; 1^+; 2^+; 3^+; 4^+) = A_4^{(1)}(\gamma; 1^+; 2^+; 3^+; 4^+) + A_4^{(1)}(\gamma; 1^+; 2^+; 3^+; 4^+); \quad (5.18)$$

with,

$$A_4^{(1)}(\gamma; 1^+; 2^+; 3^+; 4^+) = A_4^{(1)}(\gamma; 2^+; 3^+; 4^+; 1^+)_{hi j \leftrightarrow [i j]}; \quad (5.19)$$

We note that the rational terms not proportional to  $N_P$  in eq. (5.17) cancel when forming the Higgs amplitude, just as for the  $A_4^{(1)}(H; 1^+; 2^+; 3^+; 4^+)$  amplitude of ref. [20].

<sup>1</sup>Which we have checked with the aid of the package S@M [62]

The one-loop amplitudes in this paper are computed in the four-dimensional helicity scheme and are not renormalised. To perform an  $\overline{\text{MS}}$  renormalisation, one should subtract an  $\overline{\text{MS}}$  counterterm from  $A_n^{(1)}$ ,

$$A_n^{(1)} \rightarrow A_n^{(1)} - c \frac{n-0}{2} A_n^{(0)}; \quad (5.20)$$

The Wilson coefficient (2.2) produces an additional finite contribution,

$$A_n^{(1)} \rightarrow A_n^{(1)} + \frac{11}{2} A_n^{(0)}; \quad (5.21)$$

## 6. Cross Checks and Limits

### 6.1 Infrared poles

The infrared pole structure of a one-loop amplitude has the following form,

$$A_n^{(1)} = \frac{c}{2} A_n^{(0)} \sum_{i=1}^{X^n} \frac{z^2}{S_{i,i+1}} + O(\epsilon^0); \quad (6.1)$$

Since only  $A_{n,l}^{\mathcal{G}}(m;n)$  contributes at  $O(\epsilon^2)$  the IR pole structure of the general  $\mathcal{MHV}$  amplitude is identical to that of the adjacent minus case (apart from the trivial change in the tree amplitude). This combination was shown to have the correct IR behaviour in [20].

### 6.2 Collinear limits

The general behaviour of a one-loop amplitude when gluons  $i$  and  $j$  become collinear, such that  $p_i \rightarrow zK$  and  $p_{i+1} \rightarrow (1-z)K$ , is well known,

$$\begin{aligned} X \quad & A_n^{(1)}(\dots; i^i; i+1^{i+1}; \dots) \xrightarrow{ik_{i+1}} \\ & A_{n-1}^{(1)}(\dots; i^{i-1}; K^h; i+2^{i+2}; \dots) \text{Split}^{(0)}(K^h; i^i; i+1^{i+1}) \\ h= & + A_{n-1}^{(0)}(\dots; i^{i-1}; K^h; i+2^{i+2}; \dots) \text{Split}^{(1)}(K^h; i^i; i+1^{i+1}); \quad (6.2) \end{aligned}$$

The universal splitting functions are given by [1, 2, 63],

$$\text{Split}^{(0)}(K^+; 1^-; 2^+) = \mathbb{P} \frac{z^2}{z(1-z)h_{12i}}; \quad (6.3)$$

$$\text{Split}^{(0)}(K^+; 1^+; 2^-) = \mathbb{P} \frac{(1-z)^2}{z(1-z)h_{12i}}; \quad (6.4)$$

$$\text{Split}^{(0)}(K^-; 1^+; 2^+) = \mathbb{P} \frac{1}{z(1-z)h_{12i}}; \quad (6.5)$$

$$\text{Split}^{(0)}(K^-; 1^-; 2^-) = 0; \quad (6.6)$$

The one-loop splitting function can be written in terms of cut-constructible and rational components,

$$\text{Split}^{(1)}(K^h; 1^1; 2^2) = \text{Split}^{(1)\mathcal{C}}(K^h; 1^1; 2^2) + \text{Split}^{(1)\mathcal{R}}(K^h; 1^1; 2^2) \quad (6.7)$$

where

$$\begin{aligned} \text{Split}^{(1)\mathcal{C}}(K^-; 1^-; 2^+) &= \text{Split}^{(0)}(K^-; 1^-; 2^+) \frac{C}{2} \\ &\frac{2}{s_{12}} \left( 1 - {}_2F_1\left(1; -; \frac{z}{z-1}\right) - {}_2F_1\left(1; 1; \frac{z}{z-1}\right) \right); \quad (6.8) \end{aligned}$$

$$\begin{aligned} \text{Split}^{(1)\mathcal{C}}(K^+; 1^+; 2^-) &= \text{Split}^{(0)}(K^+; 1^+; 2^-) \frac{C}{2} \\ &\frac{2}{s_{12}} \left( 1 - {}_2F_1\left(1; -; \frac{z}{z-1}\right) - {}_2F_1\left(1; 1; \frac{z}{z-1}\right) \right); \quad (6.9) \end{aligned}$$

$$\text{Split}^{(1)\mathcal{C}}(K^-; 1^-; 2^-) = 0; \quad (6.10)$$

$$\text{Split}^{(1)\mathcal{R}}(K^-; 1^-; 2^+) = 0; \quad (6.11)$$

$$\text{Split}^{(1)\mathcal{R}}(K^+; 1^+; 2^-) = \frac{N_P}{96} \frac{p \sqrt{z(1-z)}}{[12]}; \quad (6.12)$$

$$\text{Split}^{(1)\mathcal{R}}(K^-; 1^-; 2^-) = \frac{N_P}{96} \frac{p \sqrt{z(1-z)} \ln 2i}{[12]^2}; \quad (6.13)$$

Explicitly, the cut-constructible parts should satisfy,

$$\begin{aligned} C_n(\dots; i^i; i+1^{i+1}; \dots) &\stackrel{ik_{i+1} X}{=} \\ &\stackrel{h=}{=} C_{n-1}(\dots; i^{i-1}; K^h; i+2^{i+2}; \dots) \text{Split}^{(0)}(K^h; i^i; i+1^{i+1}) \\ &+ A_{n-1}^{(0)}(\dots; i^{i-1}; K^h; i+2^{i+2}; \dots) \text{Split}^{(1)\mathcal{C}}(K^h; i^i; i+1^{i+1}); \quad (6.14) \end{aligned}$$

while the rational pieces obey,

$$\begin{aligned} R_n(\dots; i^i; i+1^{i+1}; \dots) &\stackrel{ik_{i+1} X}{=} \\ &\stackrel{h=}{=} R_{n-1}(\dots; i^{i-1}; K^h; i+2^{i+2}; \dots) \text{Split}^{(0)}(K^h; i^i; i+1^{i+1}) \\ &+ A_{n-1}^{(0)}(\dots; i^{i-1}; K^h; i+2^{i+2}; \dots) \text{Split}^{(1)\mathcal{R}}(K^h; i^i; i+1^{i+1}); \quad (6.15) \end{aligned}$$

### 6.3 Collinear factorisation of the cut-constructible contributions

In Ref. [20], it was demonstrated that the helicity independent cut-constructible gluonic contribution obeys,

$$\begin{aligned} C_n^{\text{fgg}}(\dots; i^i; i+1^{i+1}; \dots) &\stackrel{ik_{i+1} X}{=} \\ &\stackrel{h=}{=} C_{n-1}^{\text{fgg}}(\dots; i^{i-1}; K^h; i+2^{i+2}; \dots) \text{Split}^{(0)}(K^h; i^i; i+1^{i+1}) \\ &+ A_{n-1}^{(0)}(\dots; i^{i-1}; K^h; i+2^{i+2}; \dots) \text{Split}^{(1)\mathcal{C}}(K^h; i^i; i+1^{i+1}); \quad (6.16) \end{aligned}$$

Therefore to check the collinear behaviour of the general  $n$ -MHV amplitude, we simply need to check that the fermionic and scalar contributions satisfy the following relation,

$$\frac{C_n^{\text{fF Sg}}(\dots; i^i; i+1^{i+1}; \dots)^{ik_{i+1}}}{X_n} = \frac{C_n^{\text{fF Sg}}(\dots; i^{i-1}; K^h; i+2^{i+2}; \dots) \text{Split}^{(0)}(K^h; i^i; i+1^{i+1})}{h=}$$
 (6.17)

In other words, the F and S contributions should factorise onto the tree-level splitting amplitude for the helicity of the gluons considered. According to the definition of  $C_n$  in eq. (3.50), there is an overall factor  $A_n^{(0)}$ , which in the collinear limit produces the correct tree-level splitting function. It therefore remains to show that,

$$A_{n;l}^{\text{F};S} = A_{n;l}^{\text{F};S} \quad (6.18)$$

in the collinear limit with  $A_{n;l}^{\text{F}}(m;n)$  and  $A_{n;l}^{\text{S}}(m;n)$  given in eqs. (3.52) and (3.53) respectively.

### 6.3.1 Collinear behaviour of mixed helicity gluons

We first consider the limit where two adjacent gluons become collinear, one of which has negative helicity. For definiteness, we take the limit  $(m-1)k_m$ .

The coefficient of the box function  $b_{m-1}^{ij}$  enters both  $A^{\text{S}}$  and  $A^{\text{F}}$ . In this limit,

$$b_{m-1}^{ij} = \frac{\text{tr}(K; i; j; 1) \text{tr}(K; j; i; 1)}{s_{ij}^2 s_{1K}^2} b_{K-1}^{ij} \quad (6.19)$$

For the special cases,  $i = m-1$  and  $j = m-1$ , we have,

$$b_{m-1}^{m-1; j} = b_{m-1}^{i; m-1} = 0 \quad (6.20)$$

so that the box contribution correctly factorises onto the lower point amplitude.

The remaining terms in the sub-amplitudes are proportional to one of the auxiliary functions  $F_{m-1}^{ij}$  with  $F = A; K$  and  $I$  and which are defined in eqs. (3.40), (3.44) and (3.45). We shall see that these too have the correct factorisation properties. Let us first consider the ranges  $2 \leq i \leq m-1$  and  $m \leq j \leq n$ . When  $i = m-2$ , the momentum  $P_{(ij)}$  always contains both  $m-1$  and  $m$ , while  $P_{(ji)}$  never includes either  $m-1$  or  $m$ , and we find relations such as,

$$\frac{\text{tr}(m; P_{(ij)}; i; 1)}{s_{1m}^2} A_{m-1}^{ij} = \frac{\text{tr}(K; P_{(ij)}; i; 1)}{s_{1K}^2} A_{K-1}^{ij};$$

$$\frac{\text{tr}(1; P_{(ji)}; i; m)}{s_{1m}^2} A_{1m}^{i(j-1)} = \frac{\text{tr}(1; P_{(ji)}; i; K)}{s_{1K}^2} A_{1K}^{i(j-1)}; \quad (6.21)$$

We note that for the special case  $i = m-1$ ,

$$A_{m-1}^{m-1; j} = \frac{\text{tr}(m; j; m-1; 1)}{s_{m-1; j}} = \frac{\text{tr}(m; j; m; 1)}{s_{m; j}} = \frac{m-1}{m} \frac{1}{s_{m-1; j}} = 0;$$

$$A_{1m}^{m-1; j} = \frac{m-1}{m} \frac{1}{s_{1m}} = 0;$$

$$A_{m-1}^{i; m-1} = \frac{m-1}{m} \frac{1}{s_{m-1}} = 0; \quad (6.22)$$



Similar relations hold for the terms involving  $K$  and  $I$ . Therefore, all terms in the  $n$ -gluon version of  $A_{n,1}^F$  and  $A_{n,1}^S$  therefore either collapse onto similar terms, or vanish in such a way that the reduced summation precisely matches onto the corresponding  $A_{n-1,1}^F$  and  $A_{n-1,1}^S$ .

### 6.3.2 Two positive collinear limit

Next we consider the limit when two positive helicity gluons become collinear. We focus on the specific example where  $\ell = 1, k = 3$  with  $3 \leq m \leq 1$ . As in the previous subsection, let us first consider the ranges  $2 \leq i \leq m-1$  and  $m \leq j \leq n$ . We note that,

$$\begin{aligned} b_{1m}^{\ell=1, j} &= \frac{1!k!}{1!} b_{1m}^{K, j}; \\ b_{1m}^{\ell=j} &= \frac{1!k!}{1!} b_{1m}^{K, j}; \end{aligned} \quad (6.23)$$

The collinear factorisation of box functions has been well studied [1, 2, 63] and in this case, the relation,

$$\begin{aligned} b_{1m}^{\ell=1, j} &= F_{4F}^{2m, e}(s_{\ell=1, j}; s_{\ell=1, j-1}; s_{\ell=1, j}; s_{\ell=1, j-1}) + b_{1m}^{\ell=j} F_{4F}^{2m, e}(s_{\ell=j}; s_{\ell=j+1, j-1}; s_{\ell=j+1, j}; s_{\ell=j-1}) \\ &= \frac{1!k!}{1!} b_{1m}^{K, j} F_{4F}^{2m, e}(s_{K, j}; s_{\ell=j+1, j-1}; s_{K, j}; s_{\ell=j+1, j-1}) \end{aligned} \quad (6.24)$$

ensures the box terms correctly factorise onto the lower point amplitude.

The next set of functions we consider are the triangle functions which have  $j$  as the second index, these functions possess the general form :

$$X^{\ell} = \text{tr} (m; P_{(i, j)}; j; 1)^n F_{m-1}^{j(i-1)} L_n(P_{(i, j-1)}; P_{(i, j)}); \quad (6.25)$$

There is no contribution when  $i = \ell$ , because  $F_{m-1}^{j(\ell-1)} = F_{1m}^{j(\ell-1)} = 0$ , while the remaining  $i = \ell - 1$  contribution collapses onto the correct term,

$$\text{tr} (m; P_{(K, j)}; \ell-1; 1)^n F_{m-1}^{j(K-1)} L_n(P_{(K, j-1)}; P_{(K, j)}); \quad (6.26)$$

Similarly, when we consider

$$X^{\ell} = \text{tr} (m; P_{(j, i)}; j; 1)^n F_{1m}^{ji} L_n(P_{(j+1, i)}; P_{(j, i)}); \quad (6.27)$$

there is no contribution when  $i = \ell - 1$ , while for  $i = \ell$ , we recover the correct contribution.

The remaining types of triangle function are of the form

$$X^{\ell} = \text{tr} (m; P_{(i, j)}; i; 1)^n F_{m-1}^{ij} L_n(P_{(i+1, j)}; P_{(i, j)}); \quad (6.28)$$

Since  $F_{m1}^{(j)} = F_{m1}^{(j-1)}$  we have contributions from both terms, however, it is straightforward to show that,

$$\begin{aligned} \text{tr} (m; P_{(i-1,j)}; i'; 1; 1)^n L_n(P_{(i,j)}; P_{(i-1,j)}) + \text{tr} (m; P_{(i+1,j)}; i'; 1)^n L_n(P_{(i+1,j)}; P_{(i,j)}) \\ + \frac{1}{i!} \text{tr} (m; P_{(i+1,j)}; K; 1)^n L_n(P_{(i+1,j)}; P_{(K,j)}): \end{aligned} \quad (6.29)$$

Similar considerations apply to

$$\sum_{i=i'-1}^{X'} \text{tr} (1; P_{(j,i)}; i; m)^n F_{1m}^{i(j-1)} L_n(P_{(j,i-1)}; P_{(j,i)}); \quad (6.30)$$

thus ensuring the correct collinear factorisation.

#### 6.4 The cancellation of unphysical singularities

The cut-constructible terms eq. (3.52) – (3.53) contain poles in  $h_{ij}$ . For the most part,  $i$  and  $j$  are non-adjacent gluons and as such there should be no singularity as these become collinear. In the following section we prove that this is indeed the case. To be explicit, we consider the collinear limit  $i \rightarrow k \rightarrow j$  with,

$$\begin{aligned} i & \rightarrow zK; \\ j & \rightarrow (1-z)K; \end{aligned} \quad (6.31)$$

Let us consider the cut-constructible pieces associated with the fermionic loop contribution,  $A_{n1}^F(m; n)$  given in eq. (3.52). There are ten terms containing an explicit pole in

$s_{ij}$  which are given by,

$$\begin{aligned}
& b_{1m}^{ij} F_{4F}^{2m} e(s_{ij}; s_{i+1j-1}; s_{i+1j}; s_{ij-1}) \\
& + b_{1m}^{ij} F_{4F}^{2m} e(s_{j\dot{i}}; s_{j+1\dot{i}-1}; s_{j+1\dot{i}}; s_{j\dot{i}-1}) \\
& \frac{\text{tr}(m; P_{(i+1j)}; i; 1) \text{tr}(m; i; j; 1)}{s_{1m}^2 s_{ij}} L_1(P_{(i+1j)}; P_{(ij)}) \\
& + \frac{\text{tr}(m; P_{(i+1j-1)}; i; 1) \text{tr}(m; i; j; 1)}{s_{1m}^2 s_{ij}} L_1(P_{(i+1j-1)}; P_{(ij-1)}) \\
& \frac{\text{tr}(1; P_{(j\dot{i}-1)}; i; m) \text{tr}(1; i; j; m)}{s_{1m}^2 s_{ij}} L_1(P_{(j\dot{i}-1)}; P_{(j\dot{i})}) \\
& + \frac{\text{tr}(1; P_{(j+1\dot{i}-1)}; i; m) \text{tr}(1; i; j; m)}{s_{1m}^2 s_{ij}} L_1(P_{(j+1\dot{i}-1)}; P_{(j+1\dot{i})}) \\
& \frac{\text{tr}(m; P_{(ij-1)}; j; 1) \text{tr}(m; j; i; 1)}{s_{1m}^2 s_{ij}} L_1(P_{(ij-1)}; P_{(ij)}) \\
& + \frac{\text{tr}(m; P_{(i+1j-1)}; j; 1) \text{tr}(m; j; i; 1)}{s_{1m}^2 s_{ij}} L_1(P_{(i+1j-1)}; P_{(i+1j)}) \\
& \frac{\text{tr}(1; P_{(j+1\dot{i})}; j; m) \text{tr}(1; j; i; m)}{s_{1m}^2 s_{ij}} L_1(P_{(j+1\dot{i})}; P_{(j\dot{i})}) \\
& + \frac{\text{tr}(1; P_{(j+1\dot{i}-1)}; j; m) \text{tr}(1; j; i; m)}{s_{1m}^2 s_{ij}} L_1(P_{(j+1\dot{i}-1)}; P_{(j\dot{i}-1)}): \tag{6.32}
\end{aligned}$$

Using  $P_{(i+1j)} = P_{(i+1j-1)} + P_j$ ,  $P_{(j\dot{i}-1)} = P_{(j+1\dot{i}-1)} + P_j$ ,  $P_{(ij-1)} = P_{(i+1j-1)} + P_i$  and  $P_{(j+1\dot{i})} = P_{(j+1\dot{i}-1)} + P_i$ , as well as  $\text{tr}(1; j; i; m) = \text{tr}(1; i; j; m) + O(s_{ij})$  etc, we can rewrite these terms as

$$\begin{aligned}
& b_{1m}^{ij} F_{4F}^{2m} e(s_{ij}; s_{i+1j-1}; s_{i+1j}; s_{ij-1}) \quad s_{ij} L_1(P_{(i+1j)}; P_{(ij)}) \quad s_{ij} L_1(P_{(ij-1)}; P_{(ij)}) \\
& + b_{1m}^{ij} F_{4F}^{2m} e(s_{j\dot{i}}; s_{j+1\dot{i}-1}; s_{j+1\dot{i}}; s_{j\dot{i}-1}) \quad s_{ij} L_1(P_{(j\dot{i}-1)}; P_{(j\dot{i})}) \quad s_{ij} L_1(P_{(j+1\dot{i})}; P_{(j\dot{i})}) \\
& \frac{\text{tr}(m; P_{(i+1j-1)}; i; 1) \text{tr}(m; i; j; 1)}{s_{1m}^2 s_{ij}} \quad L_1(P_{(i+1j)}; P_{(ij)}) \quad L_1(P_{(i+1j-1)}; P_{(ij-1)}) \\
& + \frac{\text{tr}(m; P_{(i+1j-1)}; j; 1) \text{tr}(m; i; j; 1)}{s_{1m}^2 s_{ij}} \quad L_1(P_{(ij-1)}; P_{(ij)}) \quad L_1(P_{(i+1j-1)}; P_{(i+1j)}) \\
& \frac{\text{tr}(1; P_{(j+1\dot{i}-1)}; i; m) \text{tr}(1; i; j; m)}{s_{1m}^2 s_{ij}} \quad L_1(P_{(j\dot{i}-1)}; P_{(j\dot{i})}) \quad L_1(P_{(j+1\dot{i}-1)}; P_{(j+1\dot{i})}) \\
& + \frac{\text{tr}(1; P_{(j+1\dot{i}-1)}; j; m) \text{tr}(1; i; j; m)}{s_{1m}^2 s_{ij}} \quad L_1(P_{(j+1\dot{i})}; P_{(j\dot{i})}) \quad L_1(P_{(j+1\dot{i}-1)}; P_{(j\dot{i}-1)}): \tag{6.33}
\end{aligned}$$

Finally, in the  $ik \parallel j$  collinear limit,

$$\begin{aligned}
& \text{tr}(m; P_{(i+1j-1)}; i; 1) L_1(P_{(i+1j)}; P_{(ij)}) \quad L_1(P_{(i+1j-1)}; P_{(ij-1)}) \\
& ! \text{tr}(m; P_{(i+1j-1)}; j; 1) L_1(P_{(ij-1)}; P_{(ij)}) \quad L_1(P_{(i+1j-1)}; P_{(i+1j)}) \tag{6.34}
\end{aligned}$$

and noting that the combination,

$$F_{4F}^{2m_e}(s_{i,j}; s_{i+1,j-1}; s_{i+1,j}; s_{i,j-1}) - s_{ij} L_1(P_{(i+1,j)}; P_{(i,j)}) - s_{ij} L_1(P_{(i,j-1)}; P_{(i,j)}) \neq 0 (s_{ij}^2); \quad (6.35)$$

we see that all singularities cancel. The same arguments apply to the cut-constructible pieces associated with the scalar pieces.

## 6.5 Collinear factorisation of the rational pieces

This section is devoted to the collinear factorisation of the rational pieces of the four point amplitude. Since there is a  $(1 \leftrightarrow 3)$  and  $(2 \leftrightarrow 4)$  symmetry there are two independent limits  $1 \rightarrow k_2$  and  $2 \rightarrow k_3$ . We first consider the collinear limit  $2 \rightarrow k_3$ . It is straightforward to see that the amplitude correctly factorises onto:

$$\hat{R}_4(\dots; 1; 2^+; 3; 4^+) + CR_4(\dots; 1; 2^+; 3; 4^+) \stackrel{2 \rightarrow k_3}{\sim} R_3(\dots; 1; K^+; 4^+) \text{Split}^{(0)}(K^+; 2^+; 3) + R_3(\dots; 1; K^+; 4^+) \text{Split}^{(0)}(K^+; 2^+; 3): \quad (6.36)$$

In a similar fashion the remaining non-trivial collinear limit takes the form,

$$\hat{R}_4(\dots; 1; 2^+; 3; 4^+) + CR_4(\dots; 1; 2^+; 3; 4^+) \stackrel{1 \rightarrow k_2}{\sim} R_3(\dots; K^+; 3; 4^+) \text{Split}^{(0)}(K^+; 1; 2^+) + R_3(\dots; K^+; 3; 4^+) \text{Split}^{(0)}(K^+; 1; 2^+): \quad (6.37)$$

## 6.6 Soft limit of $A_4^{(1)}(\dots; 1; 2^+; 3; 4^+)$

The natural test is to take the limit as the momentum becomes soft. Our naive expectation is that in this limit, the field is essentially constant so that

$$C \text{tr} G_{SD} G_{SD}^i \neq \text{tr} G_{SD} G_{SD}^i: \quad (6.38)$$

In other words, the amplitude should collapse onto the gluon-only amplitude. Following [50], we expect that,

$$A_n^{(1)}(\dots; n, g; n_+, g^+) \stackrel{p \rightarrow 0}{\sim} n A_n^{(1)}(n, g; n_+, g^+); \quad (6.39)$$

while

$$A_n^{(1)}(\dots; n, g; n_+, g^+) \stackrel{p^y \rightarrow 0}{\sim} n_+ A_n^{(1)}(n, g; n_+, g^+): \quad (6.40)$$

We first consider the cut constructible contributions. These factorise onto the four gluon amplitude in rather trivial manner since in our construction we separated gluon-only

like diagrams and those which require a non-vanishing momentum. In the soft limit, the one and two mass easy box and triangle functions have smooth limits so that,

$$\frac{2}{m^2} \mathcal{P}^{!0} 0; \quad (6.41)$$

$$\frac{2}{s_i} \mathcal{P}^{!0} 0; \quad (6.42)$$

$$(6.43)$$

Furthermore, in the soft limit the  $L_k$  functions become the massless  $T_i$  functions defined in eq. (3.42),

$$L_k(s_{234}; s_{23}) = \frac{\text{Bub}(s_{234}) \text{Bub}(s_{23}) \mathcal{P}^{!0}}{(s_{234} s_{23})^k} \frac{(1)^k}{s_{23}^k (1-2)} \frac{2}{s_{23}} : \quad (6.44)$$

Altogether, we find that

$$C_4(1; 2^+; 3; 4^+) \mathcal{P}^{!0} 2C_4(1; 2^+; 3; 4^+); \quad (6.45)$$

where  $C_4(1; 2^+; 3; 4^+)$  is given by eq. (3.35) with  $n = 4$ . This confirms that the cut-constructible terms of the amplitude do follow the naive factorisation of eq. (6.39)

The rational terms of eqs. (5.17) and (5.2), are each apparently singular in this limit. However, careful combination reveals the soft behaviour,

$$\hat{R}_4(1; 2^+; 3; 4^+) + CR_4(1; 2^+; 3; 4^+) \mathcal{P}^{!0} \frac{N_{PC}}{3} A^{(0)}(1; 2^+; 3; 4^+); \quad (6.46)$$

This is similar to the soft limit found in ref. [20, 64] for the MHV amplitudes with adjacent negative helicities, but, as anticipated in ref. [50], is not consistent with the naive limit of eq. (6.39).

## 7. Conclusions

Previous analytic calculations of  $n$ -amplitudes at one-loop with arbitrary numbers of gluons are the adjacent minus MHV [20], the all minus [51], and the finite all plus and single plus [50]  $n$ -amplitudes. Higgs amplitudes produced by the effective interaction between Higgs and gluons induced by a heavy top quark loop, may be constructed from the sum of a  $n$ -amplitude and its parity conjugate  $\bar{y}$ . In this paper, we have extended the calculation of one-loop MHV  $n$ -amplitudes to include the general MHV configuration.

One-loop amplitudes naturally divide into cut-containing,  $C_n$ , and rational,  $R_n$ , parts. As in Ref. [20], we used the double-cut unitarity approach of ref. [4] to apply the one-loop MHV rules to derive all the multiplicity results for the cut-constructible contribution  $C_n$ . In this paper we also used the spinor integration technique of ref. [6, 7] to determine  $C_n$ , finding complete agreement between the two methods. We found that the cut-constructible terms had a natural decomposition in terms of the pure glue MHV amplitude, we discovered that the new diagrams which arose as a result of the  $\gamma$  interaction could be easily described by the basis functions used in the construction of the pure glue result. An explicit formula for the cut-constructible part of the  $n$ -amplitude are given in eq. (3.50), with the gluonic, fermionic and scalar contributions given in eqs. (3.51), (3.52) and (3.53).

The rational terms have several sources – first the cut-completion term  $CR_n$  which eliminates the unphysical poles present in  $C_n$ , second the direct on-shell recursion contribution  $R_n^D$ , third the overlap term  $O_n$  and finally from the large  $z$  limit of the cut completion terms  $\text{Inf}CR_n$ . Explicit formulae for each of these contributions are given in eqs. (3.57), (4.11), (4.21) and (4.16) respectively.

The four gluon case is worked through in detail, and an explicit solution for the  $n$ -amplitude with split helicities,  $A_4^{(1)}(\gamma; 1^-, 2^+, 3^-, 4^+)$ , together with instructions for how to assemble the Higgs amplitude  $A_4^{(1)}(H; 1^-, 2^+, 3^-, 4^+)$  are given in section 5. Numerical results for this amplitude have previously been obtained in Ref. [61]. We have checked our analytic expressions in the limit where two of the gluons are collinear, in the limit where the  $\gamma$  becomes soft and against previously known results for up to four gluons.

## Acknowledgments

Part of this work was carried out while two of the authors were attending the programme "Advancing Collider Physics: From Twistors to Monte Carlo" of the Galileo Galilei Institute for Theoretical Physics (GGI) in Florence. We thank the GGI for its hospitality and the Istituto Nazionale di Fisica Nucleare (INFN) for partial support. CW acknowledges the award of an STFC studentship.

A . Evaluation of the  $\mathcal{G}$ ,  $\mathcal{P}$  and  $\mathcal{S}$  functions.

A .1  $\mathcal{G}(i; i+1; j; j+1)$

The function  $\mathcal{G}$  is defined in eq. (3.22). Using the Schouten identity, we can rewrite it as,

$$\mathcal{G}(i; i+1; j; j+1) = G(i; j) + G(i+1; j+1) - G(i+1; j) - G(i; j+1); \quad (\text{A .1})$$

where the function  $G(i; j)$  is given by,

$$G(i; j) = \frac{h_i' h_j' i' i}{h_i' h_j' i' i} = \frac{T(i; j; i; j)}{2' p_i 2' p_j}; \quad (\text{A .2})$$

Clearly,

$$G(i; i) = 1; \quad (\text{A .3})$$

If  $i \neq j$  then

$$G(i; j) = 1 + \frac{P p_i}{2' p_i} - \frac{P p_j}{2' p_j} + \frac{N(P; p_i; p_j)}{2' p_i 2' p_j}; \quad (\text{A .4})$$

where

$$N(P; i; j) = P^2 p_i p_j - 2P p_i p_j; \quad (\text{A .5})$$

$G$  is now written in terms of scalar integrals so we can directly use the results of van Neerven [54] to perform the phase space integration:

$$\int_{\mathcal{D}} d^D \text{LIPS}(l_1; l_2; P) \frac{N(P; p_1; p_2)}{(l_1 + p_1)^2 (l_2 + p_2)^2} = \frac{c}{(4\pi)^2} 2i \sin(\theta)^2 \mathcal{P}^2 j {}_2F_1(1; \theta; 1) \frac{p_1 p_2 P^2}{N(P; p_1; p_2)} \quad (\text{A .6})$$

$$\int_{\mathcal{D}} d^D \text{LIPS}(l_1; l_2; P) \frac{2(P - p)}{(l_1 + p_1)^2} = \frac{c}{(4\pi)^2} 2i \sin(\theta)^2 \mathcal{P}^2 j \quad (\text{A .7})$$

$$\int_{\mathcal{D}} d^D \text{LIPS}(l_1; l_2; P) = \frac{c}{(4\pi)^2} (1 - 2\theta) 2i \sin(\theta)^2 \mathcal{P}^2 j \quad (\text{A .8})$$

where the factor  $c$  is given by,

$$c = (4\pi)^2 \frac{(1 + \theta)^2 (1 - \theta)}{(1 - 2\theta)}; \quad (\text{A .9})$$

The final integration is over the  $z$  variable. However, the only dependence on  $z$  appears through the quantity  $\mathcal{P}_{1,n}^2$  so it is convenient to make a change of variables,

$$\frac{dz}{z} = \frac{d(\mathcal{P})^2}{\mathcal{P}^2 - P^2} \quad (\text{A .10})$$

to produce a dispersion integral that will re-construct the parts of the cut-constructible amplitude proportional to  $(s_{1,n})^{-1}$ ,

$$\int_{\mathcal{D}} \frac{d(\mathcal{P})^2}{P^2 - \mathcal{P}^2} 2i \sin(\theta) \mathcal{P}^2 j = 2i(P^2); \quad (\text{A .11})$$

---

<sup>2</sup>Through a suitable choice of  $\theta$ , one can always ensure that  $N(P; p_1; p_2)$  is independent of  $z$  [4]

We define the function  $G(i;j)$  to be the reconstructed contribution after integration over phase space, and after performing the dispersion integration,

$$G(i;j) = \int \frac{dz}{z} \int d^D \text{LIPS}(l_1; l_2; P) G(i;j) : \quad (\text{A } .12)$$

Explicitly, we find that in the  $P^2$  channel

$$G(i;j) = \frac{c}{2} \frac{2}{P^2} \int_1^2 F_{1-1}(i; j) \frac{P_i P^2}{N(P; i; j)} + \frac{1}{1-2} \quad (\text{A } .13)$$

The terms associated with triangle and bubble contributions will always cancel in the summation of the  $G(i;j)$  leaving only the contributions from the hypergeometric function as one would expect.

### A .1.1 Spinorial Integration

Let us show how the function  $\hat{\mathcal{G}}$  can be computed via spinorial integration. It is convenient to rearrange the integrand by applying different Schouten identities from the ones used above, so that

$$\hat{G}(i; i+1; j; j+1) = (i;j) + (i+1;j) + (i;j+1) + (i+1;j+1) \quad (\text{A } .14)$$

where

$$(i;j) = \frac{h_{ij} h'_{1'2i}}{h_{i'1} h_{j'2i}} : \quad (\text{A } .15)$$

By using momentum conservation,  $l_2 = P + l_1$ , one can rewrite  $(i;j)$  in terms of  $l_1$ ,

$$(i;j) = P^2 \frac{h_{ij}}{h_{l_1 i} h_{j P} h_{l_1}} : \quad (\text{A } .16)$$

Then, one uses the rescaling in eq. (3.10), so that,

$$(i;j) = \frac{1}{t} P^2 \frac{h_{ij}}{h_{i'1} h_{j P} h_{j'}} : \quad (\text{A } .17)$$

The above expression is the integrand of the double-cut integration, defined as,

$$G^0(i;j) = \int d^D \text{LIPS}^{(4)}(i;j) : \quad (\text{A } .18)$$

By substituting the parametrization of  $d^D \text{LIPS}^{(4)}$  given in eq. (3.9), one has

$$\begin{aligned} (2^{-D})^4 G^0(i;j) &= \int \frac{h' d' i [d']}{h' j P j'} \int dt \int \frac{P^2}{h' j P j'} \frac{1}{t} P^2 \frac{h_{ij}}{h_{i'1} h_{j P} h_{j'}} \\ &= \int \frac{h' d' i [d'] P^2}{h_{i'1} h_{j P} h_{j'}} \frac{h_{ij}}{h_{i'1} h_{j P} h_{j'}} \\ &= \int \frac{h' d' i [d'] P^2}{h_{j P} h_{j'} h_{j P} h_{j'}} \frac{h_{ij} [i]}{h_{j P} h_{j'}} \end{aligned} \quad (\text{A } .19)$$



where the  $t$ -integration has been performed trivially. Before carrying through the spinor integration, we introduce a Feynman parameter to combine the two denominators depending on  $j|i$

$$G^0(i;j) = \frac{1}{(2)^4} \int_0^1 dx \int \mathcal{D}' d'i[d'] P^2 \frac{h'j|i[i]}{h'jP[j]} \frac{1}{h'jR[j]} \quad (\text{A } 20)$$

where

$$\mathcal{D}' = xK_i + (1-x)\mathcal{D}' : \quad (\text{A } 21)$$

Integrating-by-parts in  $j|i$ , using the identity,

$$\frac{h' d'i}{h'jR[j]^2} = h' d' @.i \frac{h'j|i}{h'jR[j]h'jR[j]} \quad (\text{A } 22)$$

we obtain,

$$G^0(i;j) = \frac{1}{(2)^4} \int_0^1 dx \int \mathcal{D}' d'i[d'] P^2 \frac{h'j|i[i]h'j|i}{h'jP[j]h'jR[j]h'jR[j]} : \quad (\text{A } 23)$$

The integration on  $j|$  can be performed by Cauchy's residues theorem, by taking the residues at the two poles,  $j| = \mathcal{D}' j|i$  and  $j| = \mathcal{D} j|i$ ,

$$G^0(i;j) = \frac{2 i}{(2)^4} \int_0^1 dx \frac{P^2 h'j|i h'jR[j]}{R^2 h'jP R j|i} - \frac{P^2 h'j|i h'jP[j] h'jP[j]}{h'jP R j|i h'jP R P j|i} \quad (\text{A } 24)$$

Inserting the definition of  $\mathcal{D}$  in terms of  $x$  (paying attention to  $R^2$  that is quadratic in  $x$ ), we can perform the parametric integration, and by using some spinor identities, find that

$$G^0(i;j) = \int \text{dLIPS}^{(4)}(i;j) = \frac{2 i}{(2)^4} \ln |1| P^2 \frac{h'j j|i}{h'jP[j] h'jP[j]} \quad (\text{A } 25)$$

$$= \frac{2 i}{(2)^4} \ln |1| P^2 \frac{(2p_i \cdot p)}{(2P \cdot p)(2P \cdot p)} ; \quad (\text{A } 26)$$

which corresponds to the (discontinuity of) the double-cut of (the finite part of) the one-loop box function.

A.2  $\hat{F}^{\text{D}}(i;i+1;j;j+1)$

The function  $\hat{F}^{\text{D}}$  is defined in eq. (3.30). Again we define

$$\hat{F}^{\text{D}}(i;i+1;j;j+1) = F(i;j) + F(i+1;j+1) - F(i+1;j) - F(i;j+1) \quad (\text{A } 27)$$

with,

$$F(i;j) = \frac{h' i m i h' l' _2 i h' l' _1 i}{h' i' _1 i h' j' _2 i h' l' m i^2} \quad (\text{A } 28)$$

Then after using the Schouten Identity twice this can be written as,

$$F(i;j) = \frac{hilihim ihjm ihl'_{1i}}{hijihl'_{1ihlm} i^2} + \frac{him ihjm ihl'_{2i}}{hijihl'_{2ihlm} i^2} + \frac{hilihim ihjlihjm ih'_{1'2i}}{hijihl'_{1ihj'2ihlm} i^2} \quad (\text{A } 29)$$

Promoting to traces

$$F(i;j) = \frac{\text{tr}(1;i;j;m) \text{tr}(1;'_1;i;m)}{s_{ij} s_{1m}^2 (2'_1 p_i)} + \frac{\text{tr}(1;j;i;m) \text{tr}(1;'_2;j;m)}{s_{ij} s_{1m}^2 (2'_2 p_j)} + \frac{\text{tr}(1;i;j;m) \text{tr}(1;j;i;m) \text{tr}(j;i;'_1;'_2)}{s_{ij}^2 s_{1m}^2 (2'_2 p_j)(2'_1 p_i)} \quad (\text{A } 30)$$

Which we recognise as two linear triangles and a box function similar to those in G. If we commute  $'_2$  and  $j$  in the final term we can get something which looks like eq. (A 4).

$$\frac{\text{tr}(j;i;'_1;'_2)}{(2'_1 p_i)(2'_2 p_j)} = 1 \frac{\text{tr}(j;'_1;i;'_2)}{(2'_1 p_i)(2'_2 p_j)} \quad (\text{A } 31)$$

The first term will cancel the bubbles which arise in the calculation and the remaining terms are triangles and boxes. However, since the coefficients of  $F$  depend on  $i$  and  $j$  there will no longer be a cancellation between the four terms. This is important in controlling the IR divergences of the amplitude, the triangle pieces are needed to cancel off the IR poles coming from the box functions. After performing Passarino-Veltman reduction on the tensor integrals and performing the dispersion integrals we find.

$$F(i;j) = \frac{c}{2} \frac{1}{P^2} \frac{\text{tr}(1;i;j;m) \text{tr}(1;j;i;m)}{s_{ij}^2 s_{1m}^2} (1 + 2F_1(1; i; j)) \frac{p_i \cdot p_j}{N(P; i; j)} + \frac{\text{tr}(1;i;j;m) \text{tr}(1;P;i;m)}{s_{ij} s_{1m}^2} \frac{1}{2(P p_i)} + \frac{\text{tr}(1;j;i;m) \text{tr}(1;P;j;m)}{s_{ij} s_{1m}^2} \frac{1}{2(P p_j)} \quad (\text{A } 32)$$

### A.2.1 Spinorial Integration

Alternatively the function  $F^D$  can be computed via spinorial integration. Using momentum conservation,  $l_2 = P + l_1$ , and the rescaling in eq. (3.10), one can rewrite  $F(i;j)$  of eq. (A 28) in terms of  $t$ , and  $t$ ,

$$F(i;j) = \frac{him ihjm ih'_{1ihl} jP'_{j'}}{hi'_{ihm} l i^2 h j jP'_{j'}} \quad (\text{A } 33)$$

The above expression, which turns out to be independent of  $t$ , is the integrand of the double-cut integration, defined as,

$$F^0(i;j) = \int dLIPS^{(4)} F(i;j) \quad (\text{A } 34)$$

By substituting the parametrization of dLIPS<sup>(4)</sup> given in eq. (3.9), and performing the phase-space integration with spinor-variables, one finds,

$$F^0(i;j) = \frac{[m\ j\ i\ j\ 1\ j\ n][m\ j\ j\ i\ 1\ j\ n]}{s_{ij}^2 s_{1m}^2} G^0(i;j) + \frac{2\ i}{(2\ )^4} \frac{[m\ j\ j\ i\ 1\ j\ n][m\ j\ i\ P\ 1\ j\ n]}{s_{ij} s_{1m}^2 [h\ i\ j\ P\ j]} + (i\ \$\ j) \quad ; \quad (\text{A } 35)$$

where  $G^0(i;j)$  was given in eq. (A.26). We remark that the term proportional to  $G^0(i;j)$  corresponds to the (discontinuity of) the double-cut of (the finite part of) the one-loop box function; while the rational part of eq. (A.35) corresponds to the discontinuity of logarithmic functions associated with a combination of 2-point and (1m- and 2m-) 3-point functions.

### A.3 $\mathcal{G}(i;i+1;j;j+1)$

The rational pieces of the amplitude, associated with the propagation of scalar particles around the loop, are the most complicated. The function  $\mathcal{G}$  is defined in eq. (3.31). In a similar fashion to the gluonic and fermionic pieces we define,

$$\hat{S}(i;i+1;j;j+1) = S(i;j) + S(i+1;j+1) - S(i+1;j) - S(i;j+1) \quad (\text{A } 36)$$

with

$$S(i;j) = \frac{[h\ i\ i^2\ h\ i\ i^2\ m\ i\ h\ m\ i\ h\ i\ m\ i\ h\ j\ m\ i]}{[h\ i\ m\ i^4\ h\ i\ i^2\ h\ i\ i\ h\ j\ i]} \quad (\text{A } 37)$$

After using the Schouten Identity the above can be reduced to a scalar box and third rank triangles which can be solved via Passarino-Veltman reduction generating,

$$S(i;j) = \frac{c}{2} \frac{2}{P^2} \frac{\text{tr}(1;i;j;m)^2 \text{tr}(1;j;i;m)^2}{s_{ij}^4 s_{1m}^4} {}_1F_1(1; ; 1) + \frac{p_i \cdot p^2}{N(P;i;j)} + \frac{1}{3} \frac{\text{tr}(1;i;j;m) \text{tr}(1;P;i;m)^3}{s_{ij} s_{1m}^4} \frac{1}{(2p_i \cdot P)^3} + (i\ \$\ j) + \frac{1}{2} \frac{\text{tr}(1;i;j;m)^2 \text{tr}(1;P;i;m)^2}{s_{ij}^2 s_{1m}^4} \frac{1}{(2p_i \cdot P)^2} + (i\ \$\ j) + \frac{\text{tr}(1;i;j;m)^2 \text{tr}(1;P;i;m) \text{tr}(1;j;i;m)}{s_{ij}^3 s_{1m}^4} \frac{1}{(2p_i \cdot P)} + (i\ \$\ j) \frac{1}{1-2} : \quad (\text{A } 38)$$

#### A.3.1 Spinorial Integration

Alternatively the function  $\mathcal{G}$  can be computed via spinorial integration. By using momentum conservation,  $l_2 = P + l_1$ , and the rescaling in eq. (3.10), one can rewrite eq. (A.37) in terms of  $l'$  and  $t$ ,

$$S(i;j) = t^2 \frac{[h\ i\ m\ i\ h\ j\ m\ i\ h\ m\ i\ h\ i\ l' \cdot l^2\ m\ j\ P\ j'] [h\ l\ j\ P\ j']^2}{P^4 [h\ i\ i\ h\ m\ l^4\ h\ j\ j\ P\ j']} : \quad (\text{A } 39)$$

By substituting the parametrization of  $dLIPS^{(4)}$  given in eq. (3.9), and performing the phase-space integration with spinor-variables, one obtains,

$$\begin{aligned}
S^0(i;j) &= \int dLIPS^{(4)} S(i;j) \\
&= \frac{\int \langle m j i j 1 j n \rangle^2 \int \langle m j j i 1 j n \rangle^2}{s_{ij}^4 s_{1m}^4} G^0(i;j) + \frac{2i}{(2-)^4} \left( \frac{\langle m j l i j j n \rangle \langle m j i P 1 j n \rangle}{s_{ij} s_{1m}^4 \langle hijP j \rangle} \right. \\
&\quad \left. + \frac{\langle m j i P 1 j n \rangle^2}{3 \langle hijP j \rangle^2} + \frac{\langle m j l i j j n \rangle \langle m j i P 1 j n \rangle}{2 s_{ij} \langle hijP j \rangle} \right) \\
&\quad + \frac{\langle m j l i j j n \rangle \langle m j i j 1 j n \rangle}{s_{ij}^2} + (i \leftrightarrow j) ; \tag{A.40}
\end{aligned}$$

where  $G^0(i;j)$  was given in eq. (A.26). We remark that the term proportional to  $G^0(i;j)$  corresponds to the (discontinuity of) the double-cut of (the finite part of) the one-loop box function; while the rational part of eq. (A.40) corresponds to the discontinuity of logarithmic functions associated with a combination of 2-point and (1m- and 2m-) 3-point functions.

## B. Scalar integrals

The one-loop functions that appear in the all-orders cut-constructible contribution  $C_n$  given in section 3 are defined by,

$$\begin{aligned}
F_4^{0m}(s;t) &= \frac{2}{2} \left[ \frac{2}{s} {}_2F_1\left(1; -; 1; \frac{u}{t}\right) \right. \\
&\quad \left. + \frac{2}{t} {}_2F_1\left(1; -; 1; \frac{u}{s}\right) \right]; \tag{B.1}
\end{aligned}$$

$$\begin{aligned}
F_4^{1m}(P^2; s;t) &= \frac{2}{2} \left[ \frac{2}{s} {}_2F_1\left(1; -; 1; \frac{u}{t}\right) \right. \\
&\quad \left. + \frac{2}{t} {}_2F_1\left(1; -; 1; \frac{u}{s}\right) \right. \\
&\quad \left. + \frac{2}{P^2} {}_2F_1\left(1; -; 1; \frac{uP^2}{st}\right) \right]; \tag{B.2}
\end{aligned}$$

$$\begin{aligned}
F_4^{2me}(P^2; Q^2; s;t) &= \frac{2}{2} \left[ \frac{2}{s} {}_2F_1\left(1; -; 1; \frac{us}{P^2 Q^2 st}\right) \right. \\
&\quad \left. + \frac{2}{t} {}_2F_1\left(1; -; 1; \frac{ut}{P^2 Q^2 st}\right) \right. \\
&\quad \left. + \frac{2}{P^2} {}_2F_1\left(1; -; 1; \frac{uP^2}{P^2 Q^2 st}\right) \right. \\
&\quad \left. + \frac{2}{Q^2} {}_2F_1\left(1; -; 1; \frac{uQ^2}{P^2 Q^2 st}\right) \right]; \tag{B.3}
\end{aligned}$$

and

$$F_3^{1m}(s) = \frac{1}{2} \frac{2}{s} ; \quad (B.4)$$

$$\text{Bub}(s) = \frac{1}{(1-2)} \frac{2}{s} : \quad (B.5)$$

## References

- [1] Z. Bern, L. J. Dixon, D. C. Dunbar and D. A. Kosower, One loop n-point gauge theory amplitudes, unitarity and collinear limits, Nucl. Phys. B 425 (1994) 217{260 [hep-ph/9403226].
- [2] Z. Bern, L. J. Dixon, D. C. Dunbar and D. A. Kosower, Fusing gauge theory tree amplitudes into loop amplitudes, Nucl. Phys. B 435 (1995) 59{101 [hep-ph/9409265].
- [3] F. Cachazo, P. Svrcek and E. Witten, MHV vertices and tree amplitudes in gauge theory, JHEP 09 (2004) 006 [hep-th/0403047].
- [4] A. Brandhuber, B. Spence and G. Travaglini, One-loop gauge theory amplitudes in N = 4 super Yang-Mills from MHV vertices, Nucl. Phys. B 706 (2005) 150{180 [hep-th/0407214].
- [5] R. Britto, F. Cachazo and B. Feng, Generalized unitarity and one-loop amplitudes in N = 4 super Yang-Mills, Nucl. Phys. B 725 (2005) 275{305 [hep-th/0412103].
- [6] R. Britto, E. Buchbinder, F. Cachazo and B. Feng, One-loop amplitudes of gluons in SQCD, Phys. Rev. D 72 (2005) 065012 [hep-ph/0503132].
- [7] R. Britto, B. Feng and P. Mastrolia, The cut-constructible part of QCD amplitudes, Phys. Rev. D 73 (2006) 105004 [hep-ph/0602178].
- [8] P. Mastrolia, On triple-cut of scattering amplitudes, Phys. Lett. B 644 (2007) 272{283 [hep-th/0611091].
- [9] D. Forde, Direct extraction of one-loop integral coefficients, Phys. Rev. D 75 (2007) 125019 [arXiv:0704.1835 [hep-ph]].
- [10] T. Binoth, J. P. Guillet and G. Heinrich, Algebraic evaluation of rational polynomials in one-loop amplitudes, JHEP 02 (2007) 013 [hep-ph/0609054].
- [11] T. Binoth, G. Heinrich, T. Gehrmann and P. Mastrolia, Six-Photon Amplitudes, Phys. Lett. B 649 (2007) 422{426 [hep-ph/0703311].
- [12] R. Britto, F. Cachazo and B. Feng, New recursion relations for tree amplitudes of gluons, Nucl. Phys. B 715 (2005) 499{522 [hep-th/0412308].
- [13] R. Britto, F. Cachazo, B. Feng and E. Witten, Direct proof of tree-level recursion relation in Yang-Mills theory, Phys. Rev. Lett. 94 (2005) 181602 [hep-th/0501052].

- [14] Z. Bern, L. J. Dixon and D. A. Kosower, On-shell recurrence relations for one-loop QCD amplitudes, *Phys. Rev. D* 71 (2005) 105013 [hep-th/0501240].
- [15] Z. Bern, L. J. Dixon and D. A. Kosower, The last of the finite loop amplitudes in QCD, *Phys. Rev. D* 72 (2005) 125003 [hep-ph/0505055].
- [16] Z. Bern, L. J. Dixon and D. A. Kosower, Bootstrapping multi-parton loop amplitudes in QCD, *Phys. Rev. D* 73 (2006) 065013 [hep-ph/0507005].
- [17] D. Forde and D. A. Kosower, All multiplicity one-loop corrections to MHV amplitudes in QCD, *Phys. Rev. D* 73 (2006) 061701 [hep-ph/0509358].
- [18] C. F. Berger, Z. Bern, L. J. Dixon, D. Forde and D. A. Kosower, Bootstrapping one-loop QCD amplitudes with general helicities, *Phys. Rev. D* 74 (2006) 036009 [hep-ph/0604195].
- [19] C. F. Berger, Z. Bern, L. J. Dixon, D. Forde and D. A. Kosower, All one-loop maximally helicity violating gluonic amplitudes in QCD, *Phys. Rev. D* 75 (2007) 016006 [hep-ph/0607014].
- [20] S. D. Badger, E. W. N. Glover and K. Risager, One-loop  $\phi$ -MHV amplitudes using the unitarity bootstrap, *JHEP* 07 (2007) 066 [arXiv:0704.3914 [hep-ph]].
- [21] C. F. Berger et. al., An Automated Implementation of On-Shell Methods for One-Loop Amplitudes, arXiv:0803.4180 [hep-ph].
- [22] A. Brandhuber, S. McNamara, B. Spence and G. Travaglini, Loop amplitudes in pure Yang-Mills from generalised unitarity, *JHEP* 10 (2005) 011 [hep-th/0506068].
- [23] C. Anastasiou, R. Britto, B. Feng, Z. Kunszt and P. Mastrolia, D-dimensional unitarity cut method, *Phys. Lett. B* 645 (2007) 213{216 [hep-ph/0609191].
- [24] R. Britto and B. Feng, Unitarity cuts with massive propagators and algebraic expressions for coefficients, *Phys. Rev. D* 75 (2007) 105006 [hep-ph/0612089].
- [25] C. Anastasiou, R. Britto, B. Feng, Z. Kunszt and P. Mastrolia, Unitarity cuts and reduction to master integrals in d dimensions for one-loop amplitudes, *JHEP* 03 (2007) 111 [hep-ph/0612277].
- [26] R. Britto, B. Feng and G. Yang, Complete One-Loop Amplitudes With Massless Propagators, arXiv: 0803.3147 [hep-ph].
- [27] R. Britto, B. Feng and P. Mastrolia, C-based-Form Decomposition of One-Loop Massive Amplitudes, arXiv:0803.1989 [hep-ph].
- [28] Z. Xiao, G. Yang and C.-J. Zhu, The rational part of QCD amplitude. I: The general formalism, *Nucl. Phys. B* 758 (2006) 1{34 [hep-ph/0607015].

- [29] X. Su, Z. Xiao, G. Yang and C.-J. Zhu, The rational part of QCD amplitude. II: The two-gluon, Nucl. Phys. B 758 (2006) 35{52 [hep-ph/0607016].
- [30] Z. Xiao, G. Yang and C.-J. Zhu, The rational part of QCD amplitude. III: The six-gluon, Nucl. Phys. B 758 (2006) 53{89 [hep-ph/0607017].
- [31] G. Ossola, C. G. Papadopoulos and R. Pittau, Reducing full one-loop amplitudes to scalar integrals at the integrand level, Nucl. Phys. B 763 (2007) 147{169 [hep-ph/0609007].
- [32] R. K. Ellis, W. T. Giele and Z. Kunszt, A Numerical Unitarity Formalism for Evaluating One-Loop Amplitudes, JHEP 03 (2008) 003 [arXiv:0708.2398 [hep-ph]].
- [33] G. Ossola, C. G. Papadopoulos and R. Pittau, CutTools: a program implementing the OPP reduction method to compute one-loop amplitudes, JHEP 03 (2008) 042 [arXiv:0711.3596 [hep-ph]].
- [34] W. T. Giele, Z. Kunszt and K. Melnikov, Full one-loop amplitudes from tree amplitudes, JHEP 04 (2008) 049 [arXiv:0801.2237 [hep-ph]].
- [35] G. Ossola, C. G. Papadopoulos and R. Pittau, On the Rational Terms of the one-loop amplitudes, arXiv:0802.1876 [hep-ph].
- [36] R. K. Ellis, W. T. Giele and Z. Kunszt, A Numerical Unitarity Formalism for One-Loop Amplitudes, JHEP 03 (2008) 003 [arXiv:0802.4227 [hep-ph]].
- [37] P. Mastrolia, G. Ossola, C. G. Papadopoulos and R. Pittau, Optimizing the Reduction of One-Loop Amplitudes, arXiv:0803.3964 [hep-ph].
- [38] T. Binoth, G. Ossola, C. G. Papadopoulos and R. Pittau, NLO QCD corrections to tri-boson production, arXiv:0804.0350 [hep-ph].
- [39] Z. Bern et. al., The NLO multi-leg working group: summary report, arXiv:0803.0494 [hep-ph].
- [40] M. Kramer, E. Laenen and M. Spira, Soft gluon radiation in higgs boson production at the LHC, Nucl. Phys. B 511 (1998) 523{549 [hep-ph/9611272].
- [41] U. Baur and E. W. N. Glover, Higgs boson production at large transverse momentum in hadronic collisions, Nucl. Phys. B 339 (1990) 38{66.
- [42] R. K. Ellis, I. Hinchli, M. Sobotka and J. J. van der Bij, Higgs decay to  $\gamma\gamma$ : A possible signature of intermediate mass higgs bosons at the SSC, Nucl. Phys. B 297 (1988) 221.
- [43] V. DelDuca, W. Kilgore, C. Oleari, C. Schmidt and D. Zeppenfeld, Gluon-fusion contributions to  $H + 2$  jet production, Nucl. Phys. B 616 (2001) 367 [arXiv:hep-ph/0108030].

- [44] K. G. Chetyrkin, B. A. Kniehl and M. Steinhauser, Decoupling relations to  $O(\frac{3}{s})$  and their connection to low-energy theorems, Nucl. Phys. B 510 (1998) 61{87 [hep-ph/9708255].
- [45] T. Inami, T. Kubota and Y. Okada, Effective gauge theory and the effect of heavy quarks in Higgs boson decays, Z. Phys. C 18 (1983) 69.
- [46] L. J. Dixon, E. W. N. Glover and V. V. Khoze, MHV rules for Higgs plus multi-gluon amplitudes, JHEP 12 (2004) 015 [hep-th/0411092].
- [47] S. Dawson and R. P. Kauffman, Higgs boson plus multi-jet rates at the SSC, Phys. Rev. Lett. 68 (1992) 2273{2276.
- [48] V. DelDuca, A. Frizzo and F. Maltoni, Higgs boson production in association with three jets, JHEP 05 (2004) 064 [hep-ph/0404013].
- [49] Z. Bern and D. A. Kosower, Color Decomposition of One Loop Amplitudes in Gauge Theories, Nucl. Phys. B 362 (1991) 389.
- [50] C. F. Berger, V. DelDuca and L. J. Dixon, Recursive construction of higgs+ multiparton loop amplitudes: The last of the finite loop amplitudes, Phys. Rev. D 74 (2006) 094021 [hep-ph/0608180].
- [51] S. D. Badger and E. W. N. Glover, One-loop helicity amplitudes for Higgs + gluons: The all-minus configuration, Nucl. Phys. Proc. Suppl. 160 (2006) 71{75 [hep-ph/0607139].
- [52] S. D. Badger, E. W. N. Glover and V. V. Khoze, MHV rules for Higgs plus multi-parton amplitudes, JHEP 03 (2005) 023 [hep-th/0412275].
- [53] S. D. Badger, E. W. N. Glover and K. Risager, Higgs Amplitudes From Twistor Inspired Methods, Acta Phys. Poln. B 38 (2007) 2273{2278 [0705.0264].
- [54] W. L. van Neerven, Dimensional regularization of mass and infrared singularities in two loop on-shell vertex functions, Nucl. Phys. B 268 (1986) 453.
- [55] F. Cachazo, P. Svrcek and E. Witten, Gauge theory amplitudes in twistor space and holomorphic anomaly, JHEP 10 (2004) 077 [hep-th/0409245].
- [56] F. Cachazo, Holomorphic anomaly of unitarity cuts and one-loop gauge theory amplitudes, hep-th/0410077.
- [57] R. Britto, F. Cachazo and B. Feng, Computing one-loop amplitudes from the holomorphic anomaly of unitarity cuts, Phys. Rev. D 71 (2005) 025012 [hep-th/0410179].
- [58] J. Bedford, A. Brandhuber, B. Spence and G. Travaglini, A twistor approach to one-loop amplitudes in  $N = 1$  supersymmetric Yang-Mills theory, Nucl. Phys. B 706 (2005) 100{126 [hep-th/0410280].



- [59] J. Bedford, A. Brandhuber, B. Spence and G. Travaglini, Non-supersymmetric loop amplitudes and MHV vertices, Nucl. Phys. B 712 (2005) 59{85 [hep-th/0412108].
- [60] G. Mahlon, Multi-gluon helicity amplitudes involving a quark loop, Phys. Rev. D 49 (1994) 4438{4453 [hep-ph/9312276].
- [61] J. M. Campbell, K. R. Ellis and G. Zanderighi, Next-to-leading order Higgs + 2 jet production via gluon fusion JHEP 10 (2006) 028 [hep-ph/0608194].
- [62] D. Maître P. Mastrolia S@M , a Mathematica Implementation of the Spinor-Helicity Formalism [0710.5559].
- [63] Z. Bern, V. DelDuca, W. B. Kilgore and C. R. Schmidt, The infrared behavior of one-loop QCD amplitudes at next-to-next-to-leading order, Phys. Rev. D 60 (1999) 116001 [hep-ph/9903516].
- [64] K. Risager, Unitarity and On-Shell Recursion Methods for Scattering Amplitudes, 0804.3310.