

INTERNATIONAL LINEAR COLLIDER REFERENCE DESIGN REPORT

**ILC Global Design Effort and
World Wide Study**

AUGUST, 2007

Volume 1: EXECUTIVE SUMMARY

Editors:

James Brau, Yasuhiro Okada, Nicholas Walker

Volume 2: PHYSICS AT THE ILC

Editors:

**Abdelhak Djouadi, Joseph Lykken, Klaus Mönig
Yasuhiro Okada, Mark Oreglia, Satoru Yamashita**

Volume 3: ACCELERATOR

Editors:

Nan Phinney, Nobukazu Toge, Nicholas Walker

Volume 4: DETECTORS

Editors:

Ties Behnke, Chris Damerell, John Jaros, Akiya Miyamoto

Volume 1: EXECUTIVE SUMMARY

Editors:

James Brau, Yasuhiro Okada, Nicholas Walker

List of Contributors

Gerald Aarons²⁰³, Toshinori Abe²⁹⁰, Jason Abernathy²⁹³, Medina Ablikim⁸⁷, Halina Abramowicz²¹⁶, David Adey²³⁶, Catherine Adloff¹²⁸, Chris Adolphsen²⁰³, Konstantin Afanaciev^{11,47}, Ilya Agapov^{192,35}, Jung-Keun Ahn¹⁸⁷, Hiroaki Aihara²⁹⁰, Mitsuo Akemoto⁶⁷, Maria del Carmen Alabau¹³⁰, Justin Albert²⁹³, Hartwig Albrecht⁴⁷, Michael Albrecht²⁷³, David Alesini¹³⁴, Gideon Alexander²¹⁶, Jim Alexander⁴³, Wade Allison²⁷⁶, John Amann²⁰³, Ramila Amirikas⁴⁷, Qi An²⁸³, Shozo Anami⁶⁷, B. Ananthanarayan⁷⁴, Terry Anderson⁵⁴, Ladislav Andricek¹⁴⁷, Marc Anduze⁵⁰, Michael Anerella¹⁹, Nikolai Anfimov¹¹⁵, Deepa Angal-Kalinin^{38,26}, Sergei Antipov⁸, Claire Antoine^{28,54}, Mayumi Aoki⁸⁶, Atsushi Aoza¹⁹³, Steve Aplin⁴⁷, Rob Appleby^{38,265}, Yasuo Arai⁶⁷, Sakae Araki⁶⁷, Tug Arkan⁵⁴, Ned Arnold⁸, Ray Arnold²⁰³, Richard Arnowitt²¹⁷, Xavier Artru⁸¹, Kunal Arya^{245,244}, Alexander Aryshev⁶⁷, Eri Asakawa^{149,67}, Fred Asiri²⁰³, David Asner²⁴, Muzaffer Atac⁵⁴, Grigor Atoian³²³, David Attié²⁸, Jean-Eudes Augustin³⁰², David B. Augustine⁵⁴, Bradley Ayres⁷⁸, Tariq Aziz²¹¹, Derek Baars¹⁵⁰, Frederique Badaud¹³¹, Nigel Baddams³⁵, Jonathan Bagger¹¹⁴, Sha Bai⁸⁷, David Bailey²⁶⁵, Ian R. Bailey^{38,263}, David Baker^{25,203}, Nikolai I. Balalykin¹¹⁵, Juan Pablo Balbuena³⁴, Jean-Luc Baldy³⁵, Markus Ball^{255,47}, Maurice Ball⁵⁴, Alessandro Ballestrero¹⁰³, Jamie Ballin⁷², Charles Baltay³²³, Philip Bambade¹³⁰, Syuichi Ban⁶⁷, Henry Band²⁹⁷, Karl Bane²⁰³, Bakul Banerjee⁵⁴, Serena Barbanotti⁹⁶, Daniele Barbareschi^{313,54,99}, Angela Barbaro-Galtieri¹³⁷, Desmond P. Barber^{47,38,263}, Mauricio Barbi²⁸¹, Dmitri Y. Bardin¹¹⁵, Barry Barish^{23,59}, Timothy L. Barklow²⁰³, Roger Barlow^{38,265}, Virgil E. Barnes¹⁸⁶, Maura Barone^{54,59}, Christoph Bartels⁴⁷, Valeria Bartsch²³⁰, Rahul Basu⁸⁸, Marco Battaglia^{137,239}, Yuri Batygin²⁰³, Jerome Baudot^{84,301}, Ulrich Baur²⁰⁵, D. Elwyn Baynham²⁷, Carl Beard^{38,26}, Chris Bebek¹³⁷, Philip Bechtel⁴⁷, Ulrich J. Becker¹⁴⁶, Franco Bedeschi¹⁰², Marc Bedjidian²⁹⁹, Prafulla Behera²⁶¹, Ties Behnke⁴⁷, Leo Bellantoni⁵⁴, Alain Bellerive²⁴, Paul Bellomo²⁰³, Lynn D. Bentson²⁰³, Mustapha Benyamna¹³¹, Thomas Bergauer¹⁷⁷, Edmond Berger⁸, Matthias Bergholz^{48,17}, Suman Beri¹⁷⁸, Martin Berndt²⁰³, Werner Bernreuther¹⁹⁰, Alessandro Bertolini⁴⁷, Marc Besancon²⁸, Auguste Besson^{84,301}, Andre Beteille¹³², Simona Bettoni¹³⁴, Michael Beyer³⁰⁵, R.K. Bhandari³¹⁵, Vinod Bharadwaj²⁰³, Vipin Bhatnagar¹⁷⁸, Satyaki Bhattacharya²⁴⁸, Gautam Bhattacharyya¹⁹⁴, Biplob Bhattacharjee²², Ruchika Bhuyan⁷⁶, Xiao-Jun Bi⁸⁷, Marica Biagini¹³⁴, Wilhelm Bialowons⁴⁷, Otmar Biebel¹⁴⁴, Thomas Bieler¹⁵⁰, John Bierwagen¹⁵⁰, Alison Birch^{38,26}, Mike Bisset³¹, S.S. Biswal⁷⁴, Victoria Blackmore²⁷⁶, Grahame Blair¹⁹², Guillaume Blanchard¹³¹, Gerald Blazey¹⁷¹, Andrew Blue²⁵⁴, Johannes Blümlein⁴⁸, Christian Boffo⁵⁴, Courtlandt Bohn^{171,*}, V. I. Boiko¹¹⁵, Veronique Boisvert¹⁹², Eduard N. Bondarchuk⁴⁵, Roberto Boni¹³⁴, Giovanni Bonvicini³²¹,

Stewart Boogert¹⁹², Maarten Boonekamp²⁸, Gary Boorman¹⁹², Kerstin Borrás⁴⁷,
 Daniela Bortoletto¹⁸⁶, Alessio Bosco¹⁹², Carlo Bosio³⁰⁸, Pierre Bosland²⁸, Angelo Bosotti⁹⁶,
 Vincent Boudry⁵⁰, Djamel-Eddine Boumediene¹³¹, Bernard Bouquet¹³⁰, Serguei Bourov⁴⁷,
 Gordon Bowden²⁰³, Gary Bower²⁰³, Adam Boyarski²⁰³, Ivanka Bozovic-Jelisavcic³¹⁶,
 Concezio Bozzi⁹⁷, Axel Brachmann²⁰³, Tom W. Bradshaw²⁷, Andrew Brandt²⁸⁸,
 Hans Peter Brasser⁶, Benjamin Brau²⁴³, James E. Brau²⁷⁵, Martin Breidenbach²⁰³,
 Steve Bricker¹⁵⁰, Jean-Claude Brient⁵⁰, Ian Brock³⁰³, Stanley Brodsky²⁰³,
 Craig Brooksby¹³⁸, Timothy A. Broome²⁷, David Brown¹³⁷, David Brown²⁶⁴,
 James H. Brownell⁴⁶, Mélanie Bruchon²⁸, Heiner Brueck⁴⁷, Amanda J. Brummitt²⁷,
 Nicole Brun¹³¹, Peter Buchholz³⁰⁶, Yulian A. Budagov¹¹⁵, Antonio Bulgheroni³¹⁰,
 Eugene Bulyak¹¹⁸, Adriana Bungau^{38,265}, Jochen Bürger⁴⁷, Dan Burke^{28,24},
 Craig Burkhart²⁰³, Philip Burrows²⁷⁶, Graeme Burt³⁸, David Burton^{38,136},
 Karsten Büsser⁴⁷, John Butler¹⁶, Jonathan Butterworth²³⁰, Alexei Buzulutskov²¹,
 Enric Cabruja³⁴, Massimo Caccia^{311,96}, Yunhai Cai²⁰³, Alessandro Calcaterra¹³⁴,
 Stephane Caliiier¹³⁰, Tiziano Camporesi³⁵, Jun-Jie Cao⁶⁶, J.S. Cao⁸⁷, Ofelia Capatina³⁵,
 Chiara Cappellini^{96,311}, Ruben Carcagno⁵⁴, Marcela Carena⁵⁴, Cristina Carloganu¹³¹,
 Roberto Carosi¹⁰², F. Stephen Carr²⁷, Francisco Carrion⁵⁴, Harry F. Carter⁵⁴,
 John Carter¹⁹², John Carwardine⁸, Richard Cassel²⁰³, Ronald Cassell²⁰³,
 Giorgio Cavallari²⁸, Emanuela Cavallo¹⁰⁷, Jose A. R. Cembranos^{241,269},
 Dhiman Chakraborty¹⁷¹, Frederic Chandez¹³¹, Matthew Charles²⁶¹, Brian Chase⁵⁴,
 Subhasis Chattopadhyay³¹⁵, Jacques Chauveau³⁰², Maximilien Chefdeville^{160,28},
 Robert Chehab¹³⁰, Stéphane Chel²⁸, Georgy Chelkov¹¹⁵, Chiping Chen¹⁴⁶,
 He Sheng Chen⁸⁷, Huai Bi Chen³¹, Jia Er Chen¹⁰, Sen Yu Chen⁸⁷, Shaomin Chen³¹,
 Shenjian Chen¹⁵⁷, Xun Chen¹⁴⁷, Yuan Bo Chen⁸⁷, Jian Cheng⁸⁷, M. Chevallier⁸¹,
 Yun Long Chi⁸⁷, William Chickering²³⁹, Gi-Chol Cho¹⁷⁵, Moo-Hyun Cho¹⁸²,
 Jin-Hyuk Choi¹⁸², Jong Bum Choi³⁷, Seong Youl Choi³⁷, Young-Il Choi²⁰⁸,
 Brajesh Choudhary²⁴⁸, Debajyoti Choudhury²⁴⁸, S. Rai Choudhury¹⁰⁹, David Christian⁵⁴,
 Glenn Christian²⁷⁶, Grojean Christophe^{35,29}, Jin-Hyuk Chung³⁰, Mike Church⁵⁴,
 Jacek Ciborowski²⁹⁴, Selcuk Cihangir⁵⁴, Gianluigi Ciovati²²⁰, Christine Clarke²⁷⁶,
 Don G. Clarke²⁶, James A. Clarke^{38,26}, Elizabeth Clements^{54,59}, Cornelia Coca²,
 Paul Coe²⁷⁶, John Cogan²⁰³, Paul Colas²⁸, Caroline Collard¹³⁰, Claude Colledani⁸⁴,
 Christophe Combaret²⁹⁹, Albert Comerma²³², Chris Compton¹⁵⁰, Ben Constance²⁷⁶,
 John Conway²⁴⁰, Ed Cook¹³⁸, Peter Cooke^{38,263}, William Cooper⁵⁴, Sean Corcoran³¹⁸,
 Rémi Cornat¹³¹, Laura Corner²⁷⁶, Eduardo Cortina Gil³³, W. Clay Corvin²⁰³,
 Angelo Cotta Ramusino⁹⁷, Ray Cowan¹⁴⁶, Curtis Crawford⁴³, Lucien M Cremaldi²⁷⁰,
 James A. Crittenden⁴³, David Cussans²³⁷, Jaroslav Cvach⁹⁰, Wilfrid Da Silva³⁰²,
 Hamid Dabiri Khah²⁷⁶, Anne Dabrowski¹⁷², Wladyslaw Dabrowski³, Olivier Dadoun¹³⁰,
 Jian Ping Dai⁸⁷, John Dainton^{38,263}, Colin Daly²⁹⁶, Chris Damerell²⁷, Mikhail Danilov⁹²,
 Witold Daniluk²¹⁹, Sarojini Daram²⁶⁹, Anindya Datta²², Paul Dauncey⁷², Jacques David³⁰²,
 Michel Davier¹³⁰, Ken P. Davies²⁶, Sally Dawson¹⁹, Wim De Boer³⁰⁴, Stefania De Curtis⁹⁸,
 Nicolo De Groot¹⁶⁰, Christophe De La Taille¹³⁰, Antonio de Lira²⁰³, Albert De Roeck³⁵,
 Riccardo De Sangro¹³⁴, Stefano De Santis¹³⁷, Laurence Deacon¹⁹², Aldo Deandrea²⁹⁹,
 Klaus Dehmelt⁴⁷, Eric Delagnes²⁸, Jean-Pierre Delahaye³⁵, Pierre Delebecque¹²⁸,
 Nicholas Delerue²⁷⁶, Olivier Delferriere²⁸, Marcel Demarteau⁵⁴, Zhi Deng³¹,
 Yu. N. Denisov¹¹⁵, Christopher J. Densham²⁷, Klaus Desch³⁰³, Nilendra Deshpande²⁷⁵,
 Guillaume Devanz²⁸, Erik Devetak²⁷⁶, Amos Dexter³⁸, Vito Di Benedetto¹⁰⁷,
 Ángel Diéguez²³², Ralf Diener²⁵⁵, Nguyen Dinh Dinh^{89,135}, Madhu Dixit^{24,226},

Sudhir Dixit²⁷⁶, Abdelhak Djouadi¹³³, Zdenek Dolezal³⁶, Ralph Dollan⁶⁹, Dong Dong⁸⁷,
 Hai Yi Dong⁸⁷, Jonathan Dorfan²⁰³, Andrei Dorokhov⁸⁴, George Doucas²⁷⁶,
 Robert Downing¹⁸⁸, Eric Doyle²⁰³, Guy Doziere⁸⁴, Alessandro Drago¹³⁴, Alex Dragt²⁶⁶,
 Gary Drake⁸, Zbynek Drásal³⁶, Herbert Dreiner³⁰³, Persis Drell²⁰³, Chafik Driouichi¹⁶⁵,
 Alexandr Drozhdin⁵⁴, Vladimir Drugakov^{47,11}, Shuxian Du⁸⁷, Gerald Dugan⁴³,
 Viktor Duginov¹¹⁵, Wojciech Dulinski⁸⁴, Frederic Dulucq¹³⁰, Sukanta Dutta²⁴⁹,
 Jishnu Dwivedi¹⁸⁹, Alexandre Dychkant¹⁷¹, Daniel Dzahini¹³², Guenter Eckerlin⁴⁷,
 Helen Edwards⁵⁴, Wolfgang Ehrenfeld^{255,47}, Michael Ehrlichman²⁶⁹, Heiko Ehrlichmann⁴⁷,
 Gerald Eigen²³⁵, Andrey Elagin^{115,217}, Luciano Elementi⁵⁴, Peder Eliasson³⁵, John Ellis³⁵,
 George Ellwood^{38,26}, Eckhard Elsen⁴⁷, Louis Emery⁸, Kazuhiro Enami⁶⁷, Kuninori Endo⁶⁷,
 Atsushi Enomoto⁶⁷, Fabien Eozénu²⁸, Robin Erbacher²⁴⁰, Roger Erickson²⁰³,
 K. Oleg Eyser⁴⁷, Vitaliy Fadeyev²⁴⁵, Shou Xian Fang⁸⁷, Karen Fant²⁰³, Alberto Fasso²⁰³,
 Michele Fauci Giannelli¹⁹², John Fehlberg¹⁸⁴, Lutz Feld¹⁹⁰, Jonathan L. Feng²⁴¹,
 John Ferguson³⁵, Marcos Fernandez-Garcia⁹⁵, J. Luis Fernandez-Hernando^{38,26},
 Pavel Fiala¹⁸, Ted Fieguth²⁰³, Alexander Finch¹³⁶, Giuseppe Finocchiaro¹³⁴,
 Peter Fischer²⁵⁷, Peter Fisher¹⁴⁶, H. Eugene Fisk⁵⁴, Mike D. Fitton²⁷, Ivor Fleck³⁰⁶,
 Manfred Fleischer⁴⁷, Julien Fleury¹³⁰, Kevin Flood²⁹⁷, Mike Foley⁵⁴, Richard Ford⁵⁴,
 Dominique Fortin²⁴², Brian Foster²⁷⁶, Nicolas Fourches²⁸, Kurt Francis¹⁷¹, Ariane Frey¹⁴⁷,
 Raymond Frey²⁷⁵, Horst Friedsam⁸, Josef Frisch²⁰³, Anatoli Frishman¹⁰⁷, Joel Fuerst⁸,
 Keisuke Fujii⁶⁷, Junpei Fujimoto⁶⁷, Masafumi Fukuda⁶⁷, Shigeki Fukuda⁶⁷,
 Yoshisato Funahashi⁶⁷, Warren Funk²²⁰, Julia Furletova⁴⁷, Kazuro Furukawa⁶⁷,
 Fumio Furuta⁶⁷, Takahiro Fusayasu¹⁵⁴, Juan Fuster⁹⁴, Karsten Gadow⁴⁷, Frank Gaede⁴⁷,
 Renaud Gaglione²⁹⁹, Wei Gai⁸, Jan Gajewski³, Richard Galik⁴³, Alexei Galkin¹⁷⁴,
 Valery Galkin¹⁷⁴, Laurent Gallin-Martel¹³², Fred Gannaway²⁷⁶, Jian She Gao⁸⁷, Jie Gao⁸⁷,
 Yuanning Gao³¹, Peter Garbincius⁵⁴, Luis Garcia-Tabares³³, Lynn Garren⁵⁴,
 Luís Garrido²³², Erika Garutti⁴⁷, Terry Garvey¹³⁰, Edward Garwin²⁰³, David Gascón²³²,
 Martin Gastal³⁵, Corrado Gatto¹⁰⁰, Raoul Gatto^{300,35}, Pascal Gay¹³¹, Lixin Ge²⁰³,
 Ming Qi Ge⁸⁷, Rui Ge⁸⁷, Achim Geiser⁴⁷, Andreas Gellrich⁴⁷, Jean-Francois Genat³⁰²,
 Zhe Qiao Geng⁸⁷, Simonetta Gentile³⁰⁸, Scot Gerbick⁸, Rod Gerig⁸, Dilip Kumar Ghosh²⁴⁸,
 Kirtiman Ghosh²², Lawrence Gibbons⁴³, Arnaud Giganon²⁸, Allan Gillespie²⁵⁰,
 Tony Gillman²⁷, Ilya Ginzburg^{173,201}, Ioannis Giomataris²⁸, Michele Giunta^{102,312},
 Peter Gladkikh¹¹⁸, Janusz Gluza²⁸⁴, Rohini Godbole⁷⁴, Stephen Godfrey²⁴,
 Gerson Goldhaber^{137,239}, Joel Goldstein²³⁷, George D. Gollin²⁶⁰,
 Francisco Javier Gonzalez-Sanchez⁹⁵, Maurice Goodrick²⁴⁶, Yuri Gornushkin¹¹⁵,
 Mikhail Gostkin¹¹⁵, Erik Gottschalk⁵⁴, Philippe Goudket^{38,26}, Ivo Gough Eschrich²⁴¹,
 Filimon Gournaris²³⁰, Ricardo Graciani²³², Norman Graf²⁰³, Christian Grah⁴⁸,
 Francesco Grancagnolo⁹⁹, Damien Grandjean⁸⁴, Paul Grannis²⁰⁶, Anna Grassellino²⁷⁹,
 Eugeni Graugés²³², Stephen Gray⁴³, Michael Green¹⁹², Justin Greenhalgh^{38,26},
 Timothy Greenshaw²⁶³, Christian Grefe²⁵⁵, Ingrid-Maria Gregor⁴⁷, Gerald Grenier²⁹⁹,
 Mark Grimes²³⁷, Terry Grimm¹⁵⁰, Philippe Gris¹³¹, Jean-Francois Grivaz¹³⁰,
 Marius Groll²⁵⁵, Jeffrey Gronberg¹³⁸, Denis Grondin¹³², Donald Groom¹³⁷, Eilam Gross³²²,
 Martin Grunewald²³¹, Claus Grupen³⁰⁶, Grzegorz Grzelak²⁹⁴, Jun Gu⁸⁷, Yun-Ting Gu⁶¹,
 Monoranjan Guchait²¹¹, Susanna Guiducci¹³⁴, Ali Murat Guler¹⁵¹, Hayg Guler⁵⁰,
 Erhan Gulmez^{261,15}, John Gunion²⁴⁰, Zhi Yu Guo¹⁰, Atul Gurtu²¹¹, Huy Bang Ha¹³⁵,
 Tobias Haas⁴⁷, Andy Haase²⁰³, Naoyuki Haba¹⁷⁶, Howard Haber²⁴⁵, Stephan Haensel¹⁷⁷,
 Lars Hage⁴⁷, Hiroyuki Hagura^{67,117}, Csaba Hajdu⁷⁰, Gunther Haller²⁰³,
 Johannes Haller²⁵⁵, Lea Hallermann^{47,255}, Valerie Halyo¹⁸⁵, Koichi Hamaguchi²⁹⁰,

Larry Hammond⁵⁴, Liang Han²⁸³, Tao Han²⁹⁷, Louis Hand⁴³, Virender K. Handu¹³,
 Hitoshi Hano²⁹⁰, Christian Hansen²⁹³, Jørn Dines Hansen¹⁶⁵, Jorgen Beck Hansen¹⁶⁵,
 Kazufumi Hara⁶⁷, Kristian Harder²⁷, Anthony Hartin²⁷⁶, Walter Hartung¹⁵⁰,
 Carsten Hast²⁰³, John Hauptman¹⁰⁷, Michael Hauschild³⁵, Claude Hauviller³⁵,
 Miroslav Havranek⁹⁰, Chris Hawkes²³⁶, Richard Hawkings³⁵, Hitoshi Hayano⁶⁷,
 Masashi Hazumi⁶⁷, An He⁸⁷, Hong Jian He³¹, Christopher Hearty²³⁸, Helen Heath²³⁷,
 Thomas Hebbeker¹⁹⁰, Vincent Hedberg¹⁴⁵, David Hedin¹⁷¹, Samuel Heifets²⁰³,
 Sven Heinemeyer⁹⁵, Sebastien Heini⁸⁴, Christian Helebrant^{47,255}, Richard Helms⁴³,
 Brian Heltsley⁴³, Sophie Henrot-Versille¹³⁰, Hans Henschel⁴⁸, Carsten Hensel²⁶²,
 Richard Hermel¹²⁸, Atilà Herms²³², Gregor Herten⁴, Stefan Hesselbach²⁸⁵,
 Rolf-Dieter Heuer^{47,255}, Clemens A. Heusch²⁴⁵, Joanne Hewett²⁰³, Norio Higashi⁶⁷,
 Takatoshi Higashi¹⁹³, Yasuo Higashi⁶⁷, Toshiyasu Higo⁶⁷, Michael D. Hildreth²⁷³,
 Karlheinz Hiller⁴⁸, Sonja Hillert²⁷⁶, Stephen James Hillier²³⁶, Thomas Himel²⁰³,
 Abdelkader Himmi⁸⁴, Ian Hinchliffe¹³⁷, Zenro Hioki²⁸⁹, Koichiro Hirano¹¹²,
 Tachishige Hirose³²⁰, Hiromi Hisamatsu⁶⁷, Junji Hisano⁸⁶, Chit Thu Hlaing²³⁹,
 Kai Meng Hock^{38,263}, Martin Hoferkamp²⁷², Mark Hohlfeld³⁰³, Yousuke Honda⁶⁷,
 Juho Hong¹⁸², Tae Min Hong²⁴³, Hiroyuki Honma⁶⁷, Yasuyuki Horii²²², Dezso Horvath⁷⁰,
 Kenji Hosoyama⁶⁷, Jean-Yves Hostachy¹³², Mi Hou⁸⁷, Wei-Shu Hou¹⁶⁴, David Howell²⁷⁶,
 Maxine Hronek^{54,59}, Yee B. Hsiung¹⁶⁴, Bo Hu¹⁵⁶, Tao Hu⁸⁷, Jung-Yun Huang¹⁸²,
 Tong Ming Huang⁸⁷, Wen Hui Huang³¹, Emil Huedem⁵⁴, Peter Huggard²⁷,
 Cyril Hugonie¹²⁷, Christine Hu-Guo⁸⁴, Katri Huitu^{258,65}, Youngseok Hwang³⁰,
 Marek Idzik³, Alexandr Ignatenko¹¹, Fedor Ignatov²¹, Hirokazu Ikeda¹¹¹,
 Katsumasa Ikematsu⁴⁷, Tatiana Ilicheva^{115,60}, Didier Imbault³⁰², Andreas Imhof²⁵⁵,
 Marco Incagli¹⁰², Ronen Ingbir²¹⁶, Hitoshi Inoue⁶⁷, Youichi Inoue²²¹, Gianluca Introzzi²⁷⁸,
 Katerina Ioakeimidi²⁰³, Satoshi Ishihara²⁵⁹, Akimasa Ishikawa¹⁹³, Tadashi Ishikawa⁶⁷,
 Vladimir Issakov³²³, Kazutoshi Ito²²², V. V. Ivanov¹¹⁵, Valentin Ivanov⁵⁴,
 Yury Ivanyushenkov²⁷, Masako Iwasaki²⁹⁰, Yoshihisa Iwashita⁸⁵, David Jackson²⁷⁶,
 Frank Jackson^{38,26}, Bob Jacobsen^{137,239}, Ramaswamy Jaganathan⁸⁸, Steven Jamison^{38,26},
 Matthias Enno Janssen^{47,255}, Richard Jaramillo-Echeverria⁹⁵, John Jaros²⁰³,
 Clement Jauffret⁵⁰, Suresh B. Jawale¹³, Daniel Jeans¹²⁰, Ron Jedziniak⁵⁴, Ben Jeffery²⁷⁶,
 Didier Jehanno¹³⁰, Leo J. Jenner^{38,263}, Chris Jensen⁵⁴, David R. Jensen²⁰³,
 Hairong Jiang¹⁵⁰, Xiao Ming Jiang⁸⁷, Masato Jimbo²²³, Shan Jin⁸⁷, R. Keith Jobe²⁰³,
 Anthony Johnson²⁰³, Erik Johnson²⁷, Matt Johnson¹⁵⁰, Michael Johnston²⁷⁶,
 Paul Joireman⁵⁴, Stevan Jokic³¹⁶, James Jones^{38,26}, Roger M. Jones^{38,265},
 Erik Jongewaard²⁰³, Leif Jönsson¹⁴⁵, Gopal Joshi¹³, Satish C. Joshi¹⁸⁹, Jin-Young Jung¹³⁷,
 Thomas Junk²⁶⁰, Aurelio Juste⁵⁴, Marumi Kado¹³⁰, John Kadyk¹³⁷, Daniela Käfer⁴⁷,
 Eiji Kako⁶⁷, Puneeth Kalavase²⁴³, Alexander Kalinin^{38,26}, Jan Kalinowski²⁹⁵,
 Takuya Kamitani⁶⁷, Yoshio Kamiya¹⁰⁶, Yukihide Kamiya⁶⁷, Jun-ichi Kamoshita⁵⁵,
 Sergey Kananov²¹⁶, Kazuyuki Kanaya²⁹², Ken-ichi Kanazawa⁶⁷, Shinya Kanemura²²⁵,
 Heung-Sik Kang¹⁸², Wen Kang⁸⁷, D. Kanjial¹⁰⁵, Frédéric Kapusta³⁰², Pavel Karataev¹⁹²,
 Paul E. Karchin³²¹, Dean Karlen^{293,226}, Yannis Karyotakis¹²⁸, Vladimir Kashikhin⁵⁴,
 Shigeru Kashiwagi¹⁷⁶, Paul Kasley⁵⁴, Hiroaki Katagiri⁶⁷, Takashi Kato¹⁶⁷, Yukihiro Kato¹¹⁹,
 Judith Katzy⁴⁷, Alexander Kaukher³⁰⁵, Manjit Kaur¹⁷⁸, Kiyotomo Kawagoe¹²⁰,
 Hiroyuki Kawamura¹⁹¹, Sergei Kazakov⁶⁷, V. D. Kekelidze¹¹⁵, Lewis Keller²⁰³,
 Michael Kelley³⁹, Marc Kelly²⁶⁵, Michael Kelly⁸, Kurt Kennedy¹³⁷, Robert Kephart⁵⁴,
 Justin Keung^{279,54}, Oleg Khainovski²³⁹, Sameen Ahmed Khan¹⁹⁵, Prashant Khare¹⁸⁹,
 Nikolai Khovansky¹¹⁵, Christian Kiesling¹⁴⁷, Mitsuo Kikuchi⁶⁷, Wolfgang Kilian³⁰⁶,

Martin Killenberg³⁰³, Donghee Kim³⁰, Eun San Kim³⁰, Eun-Joo Kim³⁷, Guinyun Kim³⁰,
 Hongjoo Kim³⁰, Hyoungsuk Kim³⁰, Hyun-Chui Kim¹⁸⁷, Jonghoon Kim²⁰³, Kwang-Je Kim⁸,
 Kyung Sook Kim³⁰, Peter Kim²⁰³, Seunghwan Kim¹⁸², Shin-Hong Kim²⁹², Sun Kee Kim¹⁹⁷,
 Tae Jeong Kim¹²⁵, Youngim Kim³⁰, Young-Kee Kim^{54,52}, Maurice Kimmitt²⁵²,
 Robert Kirby²⁰³, François Kircher²⁸, Danuta Kisielewska³, Olaf Kittel³⁰³,
 Robert Klanner²⁵⁵, Arkadiy L. Klebaner⁵⁴, Claus Kleinwort⁴⁷, Tatsiana Klimkovich⁴⁷,
 Esben Klinkby¹⁶⁵, Stefan Kluth¹⁴⁷, Marc Knecht³², Peter Kneisel²²⁰, In Soo Ko¹⁸²,
 Kwok Ko²⁰³, Makoto Kobayashi⁶⁷, Nobuko Kobayashi⁶⁷, Michael Kobel²¹⁴,
 Manuel Koch³⁰³, Peter Kodys³⁶, Uli Koetz⁴⁷, Robert Kohrs³⁰³, Yuuji Kojima⁶⁷,
 Hermann Kolanoski⁶⁹, Karol Kolodziej²⁸⁴, Yury G. Kolomensky²³⁹, Sachio Komamiya¹⁰⁶,
 Xiang Cheng Kong⁸⁷, Jacobo Konigsberg²⁵³, Volker Korb⁴⁷, Shane Koscielniak²²⁶,
 Sergey Kostromin¹¹⁵, Robert Kowalewski²⁹³, Sabine Kraml³⁵, Manfred Krammer¹⁷⁷,
 Anatoly Krasnykh²⁰³, Thorsten Krautscheid³⁰³, Maria Krawczyk²⁹⁵, H. James Krebs²⁰³,
 Kurt Krempetz⁵⁴, Graham Kribs²⁷⁵, Srinivas Krishnagopal¹⁸⁹, Richard Kriske²⁶⁹,
 Andreas Kronfeld⁵⁴, Jürgen Kroseberg²⁴⁵, Uladzimir Kruchonak¹¹⁵, Dirk Kruecker⁴⁷,
 Hans Krüger³⁰³, Nicholas A. Krumpa²⁶, Zinovii Krumshstein¹¹⁵, Yu Ping Kuang³¹,
 Kiyoshi Kubo⁶⁷, Vic Kuchler⁵⁴, Noboru Kudoh⁶⁷, Szymon Kulis³, Masayuki Kumada¹⁶¹,
 Abhay Kumar¹⁸⁹, Tatsuya Kume⁶⁷, Anirban Kundu²², German Kurevlev^{38,265},
 Yoshimasa Kurihara⁶⁷, Masao Kuriki⁶⁷, Shigeru Kuroda⁶⁷, Hirotoshi Kuroiwa⁶⁷,
 Shin-ichi Kurokawa⁶⁷, Tomonori Kusano²²², Pradeep K. Kush¹⁸⁹, Robert Kutschke⁵⁴,
 Ekaterina Kuznetsova³⁰⁸, Peter Kvasnicka³⁶, Youngjoon Kwon³²⁴, Luis Labarga²²⁸,
 Carlos Lacasta⁹⁴, Sharon Lackey⁵⁴, Thomas W. Lackowski⁵⁴, Remi Lafaye¹²⁸,
 George Lafferty²⁶⁵, Eric Lagorio¹³², Imad Laktineh²⁹⁹, Shankar Lal¹⁸⁹, Maurice Laloum⁸³,
 Briant Lam²⁰³, Mark Lancaster²³⁰, Richard Lander²⁴⁰, Wolfgang Lange⁴⁸,
 Ulrich Langenfeld³⁰³, Willem Langeveld²⁰³, David Larbalestier²⁹⁷, Ray Larsen²⁰³,
 Tomas Lastovicka²⁷⁶, Gordana Lastovicka-Medin²⁷¹, Andrea Latina³⁵, Emmanuel Latour⁵⁰,
 Lisa Laurent²⁰³, Ba Nam Le⁶², Duc Ninh Le^{89,129}, Francois Le Diberder¹³⁰,
 Patrick Le Du²⁸, Hervé Lebbolo⁸³, Paul Lebrun⁵⁴, Jacques Lecoq¹³¹, Sung-Won Lee²¹⁸,
 Frank Lehner⁴⁷, Jerry Leibfritz⁵⁴, Frank Lenkszus⁸, Tadeusz Lesiak²¹⁹, Aharon Levy²¹⁶,
 Jim Lewandowski²⁰³, Greg Leyh²⁰³, Cheng Li²⁸³, Chong Sheng Li¹⁰, Chun Hua Li⁸⁷,
 Da Zhang Li⁸⁷, Gang Li⁸⁷, Jin Li³¹, Shao Peng Li⁸⁷, Wei Ming Li¹⁶², Weiguo Li⁸⁷,
 Xiao Ping Li⁸⁷, Xue-Qian Li¹⁵⁸, Yuanjing Li³¹, Yulan Li³¹, Zenghai Li²⁰³, Zhong Quan Li⁸⁷,
 Jian Tao Liang²¹², Yi Liao¹⁵⁸, Lutz Lilje⁴⁷, J. Guilherme Lima¹⁷¹, Andrew J. Lintern²⁷,
 Ronald Lipton⁵⁴, Benno List²⁵⁵, Jenny List⁴⁷, Chun Liu⁹³, Jian Fei Liu¹⁹⁹, Ke Xin Liu¹⁰,
 Li Qiang Liu²¹², Shao Zhen Liu⁸⁷, Sheng Guang Liu⁶⁷, Shubin Liu²⁸³, Wanming Liu⁸,
 Wei Bin Liu⁸⁷, Ya Ping Liu⁸⁷, Yu Dong Liu⁸⁷, Nigel Lockyer^{226,238}, Heather E. Logan²⁴,
 Pavel V. Logatchev²¹, Wolfgang Lohmann⁴⁸, Thomas Lohse⁶⁹, Smaragda Lola²⁷⁷,
 Amparo Lopez-Virto⁹⁵, Peter Loveridge²⁷, Manuel Lozano³⁴, Cai-Dian Lu⁸⁷,
 Changguo Lu¹⁸⁵, Gong-Lu Lu⁶⁶, Wen Hui Lu²¹², Henry Lubatti²⁹⁶, Arnaud Lucotte¹³²,
 Björn Lundberg¹⁴⁵, Tracy Lundin⁶³, Mingxing Luo³²⁵, Michel Luong²⁸, Vera Luth²⁰³,
 Benjamin Lutz^{47,255}, Pierre Lutz²⁸, Thorsten Lux²²⁹, Pawel Luzniak⁹¹, Alexey Lyapin²³⁰,
 Joseph Lykken⁵⁴, Clare Lynch²³⁷, Li Ma⁸⁷, Lili Ma^{38,26}, Qiang Ma⁸⁷, Wen-Gan Ma^{283,87},
 David Macfarlane²⁰³, Arthur Maciel¹⁷¹, Allan MacLeod²³³, David MacNair²⁰³,
 Wolfgang Mader²¹⁴, Stephen Magill⁸, Anne-Marie Magnan⁷², Bino Maiheu²³⁰,
 Manas Maity³¹⁹, Millicent Majchrzak²⁶⁹, Gobinda Majumder²¹¹, Roman Makarov¹¹⁵,
 Dariusz Makowski^{213,47}, Bogdan Malaescu¹³⁰, C. Mallik³¹⁵, Usha Mallik²⁶¹,
 Stephen Malton^{230,192}, Oleg B. Malyshev^{38,26}, Larisa I. Malysheva^{38,263},

John Mammosser²²⁰, Mamta²⁴⁹, Judita Mamuzic^{48,316}, Samuel Manen¹³¹,
 Massimo Manghisoni^{307,101}, Steven Manly²⁸², Fabio Marcellini¹³⁴, Michal Marcisovsky⁹⁰,
 Thomas W. Markiewicz²⁰³, Steve Marks¹³⁷, Andrew Marone¹⁹, Felix Marti¹⁵⁰,
 Jean-Pierre Martin⁴², Victoria Martin²⁵¹, Gisèle Martin-Chassard¹³⁰, Manel Martinez²²⁹,
 Celso Martinez-Rivero⁹⁵, Dennis Martsch²⁵⁵, Hans-Ulrich Martyn^{190,47},
 Takashi Maruyama²⁰³, Mika Masuzawa⁶⁷, Hervé Mathez²⁹⁹, Takeshi Matsuda⁶⁷,
 Hiroshi Matsumoto⁶⁷, Shuji Matsumoto⁶⁷, Toshihiro Matsumoto⁶⁷, Hiroyuki Matsunaga¹⁰⁶,
 Peter Mättig²⁹⁸, Thomas Mattison²³⁸, Georgios Mavromanolakis^{246,54},
 Kentarou Mawatari¹²⁴, Anna Mazzacane³¹³, Patricia McBride⁵⁴, Douglas McCormick²⁰³,
 Jeremy McCormick²⁰³, Kirk T. McDonald¹⁸⁵, Mike McGee⁵⁴, Peter McIntosh^{38,26},
 Bobby McKee²⁰³, Robert A. McPherson²⁹³, Mandi Meidlinger¹⁵⁰, Karlheinz Meier²⁵⁷,
 Barbara Mele³⁰⁸, Bob Meller⁴³, Isabell-Alissandra Melzer-Pellmann⁴⁷, Hector Mendez²⁸⁰,
 Adam Mercer^{38,265}, Mikhail Merkin¹⁴¹, I. N. Meshkov¹¹⁵, Robert Messner²⁰³,
 Jessica Metcalfe²⁷², Chris Meyer²⁴⁴, Hendrik Meyer⁴⁷, Joachim Meyer⁴⁷, Niels Meyer⁴⁷,
 Norbert Meyners⁴⁷, Paolo Michelato⁹⁶, Shinichiro Michizono⁶⁷, Daniel Mihalcea¹⁷¹,
 Satoshi Mihara¹⁰⁶, Takanori Mihara¹²⁶, Yoshinari Mikami²³⁶,
 Alexander A. Mikhailichenko⁴³, Catia Milardi¹³⁴, David J. Miller²³⁰, Owen Miller²³⁶,
 Roger J. Miller²⁰³, Caroline Milstene⁵⁴, Toshihiro Mimashi⁶⁷, Irakli Minashvili¹¹⁵,
 Ramon Miquel^{229,80}, Shekhar Mishra⁵⁴, Winfried Mitaroff¹⁷⁷, Chad Mitchell²⁶⁶,
 Takako Miura⁶⁷, Akiya Miyamoto⁶⁷, Hitoshi Miyata¹⁶⁶, Ulf Mjörnmark¹⁴⁵,
 Joachim Mnich⁴⁷, Klaus Moenig⁴⁸, Kenneth Moffeit²⁰³, Nikolai Mokhov⁵⁴,
 Stephen Molloy²⁰³, Laura Monaco⁹⁶, Paul R. Monasterio²³⁹, Alessandro Montanari⁴⁷,
 Sung Ik Moon¹⁸², Gudrid A. Moortgat-Pick^{38,49}, Paulo Mora De Freitas⁵⁰, Federic Morel⁸⁴,
 Stefano Moretti²⁸⁵, Vasily Morgunov^{47,92}, Toshinori Mori¹⁰⁶, Laurent Morin¹³²,
 François Morisseau¹³¹, Yoshiyuki Morita⁶⁷, Youhei Morita⁶⁷, Yuichi Morita¹⁰⁶,
 Nikolai Morozov¹¹⁵, Yuichi Morozumi⁶⁷, William Morse¹⁹, Hans-Guenther Moser¹⁴⁷,
 Gilbert Moulta¹²⁷, Sekazi Mtingwa¹⁴⁶, Mihajlo Mudrinic³¹⁶, Alex Mueller⁸¹,
 Wolfgang Mueller⁸², Astrid Muennich¹⁹⁰, Milada Margarete Muhlleitner^{129,35},
 Bhaskar Mukherjee⁴⁷, Biswarup Mukhopadhyaya⁶⁴, Thomas Müller³⁰⁴, Morrison Munro²⁰³,
 Hitoshi Murayama^{239,137}, Toshiya Muto²²², Ganapati Rao Myneni²²⁰, P.Y. Nabhiraj³¹⁵,
 Sergei Nagaitsev⁵⁴, Tadashi Nagamine²²², Ai Nagano²⁹², Takashi Naito⁶⁷, Hirotaka Nakai⁶⁷,
 Hiromitsu Nakajima⁶⁷, Isamu Nakamura⁶⁷, Tomoya Nakamura²⁹⁰, Tsutomu Nakanishi¹⁵⁵,
 Katsumi Nakao⁶⁷, Noriaki Nakao⁵⁴, Kazuo Nakayoshi⁶⁷, Sang Nam¹⁸², Yoshihito Namito⁶⁷,
 Won Namkung¹⁸², Chris Nantista²⁰³, Olivier Napoly²⁸, Meenakshi Narain²⁰,
 Beate Naroska²⁵⁵, Uriel Nauenberg²⁴⁷, Ruchika Nayyar²⁴⁸, Homer Neal²⁰³,
 Charles Nelson²⁰⁴, Janice Nelson²⁰³, Timothy Nelson²⁰³, Stanislav Nemecek⁹⁰,
 Michael Neubauer²⁰³, David Neuffer⁵⁴, Myriam Q. Newman²⁷⁶, Oleg Nezhevenko⁵⁴,
 Cho-Kuen Ng²⁰³, Anh Ky Nguyen^{89,135}, Minh Nguyen²⁰³, Hong Van Nguyen Thi^{1,89},
 Carsten Niebuhr⁴⁷, Jim Niehoff⁵⁴, Piotr Niezurawski²⁹⁴, Tomohiro Nishitani¹¹²,
 Osamu Nitoh²²⁴, Shuichi Noguchi⁶⁷, Andrei Nomerotski²⁷⁶, John Noonan⁸,
 Edward Norbeck²⁶¹, Yuri Nosochkov²⁰³, Dieter Notz⁴⁷, Grazyna Nowak²¹⁹,
 Hannelies Nowak⁴⁸, Matthew Noy⁷², Mitsuaki Nozaki⁶⁷, Andreas Nyffeler⁶⁴,
 David Nygren¹³⁷, Piermaria Oddone⁵⁴, Joseph O'Dell^{38,26}, Jong-Seok Oh¹⁸²,
 Sun Kun Oh¹²², Kazumasa Ohkuma⁵⁶, Martin Ohlerich^{48,17}, Kazuhito Ohmi⁶⁷,
 Yukiyo Ohnishi⁶⁷, Satoshi Ohsawa⁶⁷, Norihito Ohuchi⁶⁷, Katsunobu Oide⁶⁷,
 Nobuchika Okada⁶⁷, Yasuhiro Okada^{67,202}, Takahiro Okamura⁶⁷, Toshiyuki Okugi⁶⁷,
 Shoji Okumi¹⁵⁵, Ken-ichi Okumura²²², Alexander Olchevski¹¹⁵, William Oliver²²⁷,

Bob Olivier¹⁴⁷, James Olsen¹⁸⁵, Jeff Olsen²⁰³, Stephen Olsen²⁵⁶, A. G. Olshevsky¹¹⁵,
 Jan Olsson⁴⁷, Tsunehiko Omori⁶⁷, Yasar Onel²⁶¹, Gulsen Onengut⁴⁴, Hiroaki Ono¹⁶⁸,
 Dmitry Onoprienko¹¹⁶, Mark Oreglia⁵², Will Oren²²⁰, Toyoko J. Orimoto²³⁹,
 Marco Oriunno²⁰³, Marius Ciprian Orlandea², Masahiro Oroku²⁹⁰, Lynne H. Orr²⁸²,
 Robert S. Orr²⁹¹, Val Oshea²⁵⁴, Anders Oskarsson¹⁴⁵, Per Osland²³⁵, Dmitri Ossetski¹⁷⁴,
 Lennart Österman¹⁴⁵, Francois Ostiguy⁵⁴, Hidetoshi Otono²⁹⁰, Brian Ottewell²⁷⁶,
 Qun Ouyang⁸⁷, Hasan Padamsee⁴³, Cristobal Padilla²²⁹, Carlo Pagani⁹⁶, Mark A. Palmer⁴³,
 Wei Min Pam⁸⁷, Manjiri Pande¹³, Rajni Pande¹³, V.S. Pandit³¹⁵, P.N. Pandita¹⁷⁰,
 Mila Pandurovic³¹⁶, Alexander Pankov^{180,179}, Nicola Panzeri⁹⁶, Zisis Papandreou²⁸¹,
 Rocco Paparella⁹⁶, Adam Para⁵⁴, Hwanbae Park³⁰, Brett Parker¹⁹, Chris Parkes²⁵⁴,
 Vittorio Parma³⁵, Zohreh Parsa¹⁹, Justin Parsons²⁶¹, Richard Partridge^{20,203},
 Ralph Pasquinelli⁵⁴, Gabriella Pásztor^{242,70}, Ewan Paterson²⁰³, Jim Patrick⁵⁴,
 Piero Patteri¹³⁴, J. Ritchie Patterson⁴³, Giovanni Pauletta³¹⁴, Nello Paver³⁰⁹,
 Vince Pavlicek⁵⁴, Bogdan Pawlik²¹⁹, Jacques Payet²⁸, Norbert Pchalek⁴⁷, John Pedersen³⁵,
 Guo Xi Pei⁸⁷, Shi Lun Pei⁸⁷, Jerzy Pelka¹⁸³, Giulio Pellegrini³⁴, David Pellett²⁴⁰,
 G.X. Peng⁸⁷, Gregory Penn¹³⁷, Aldo Penzo¹⁰⁴, Colin Perry²⁷⁶, Michael Peskin²⁰³,
 Franz Peters²⁰³, Troels Christian Petersen^{165,35}, Daniel Peterson⁴³, Thomas Peterson⁵⁴,
 Maureen Petterson^{245,244}, Howard Pfeffer⁵⁴, Phil Pfund⁵⁴, Alan Phelps²⁸⁶,
 Quang Van Phi⁸⁹, Jonathan Phillips²⁵⁰, Nan Phinney²⁰³, Marcello Piccolo¹³⁴,
 Livio Piemontese⁹⁷, Paolo Pierini⁹⁶, W. Thomas Piggott¹³⁸, Gary Pike⁵⁴, Nicolas Pillet⁸⁴,
 Talini Pinto Jayawardena²⁷, Phillippe Piot¹⁷¹, Kevin Pitts²⁶⁰, Mauro Pivi²⁰³,
 Dave Plate¹³⁷, Marc-Andre Pleier³⁰³, Andrei Poblaguev³²³, Michael Poehler³²³,
 Matthew Poelker²²⁰, Paul Poffenberger²⁹³, Igor Pogorelsky¹⁹, Freddy Poirier⁴⁷,
 Ronald Poling²⁶⁹, Mike Poole^{38,26}, Sorina Popescu², John Popielarski¹⁵⁰, Roman Pöschl¹³⁰,
 Martin Postranecky²³⁰, Prakash N. Potukochi¹⁰⁵, Julie Prast¹²⁸, Serge Prat¹³⁰,
 Miro Preger¹³⁴, Richard Prepost²⁹⁷, Michael Price¹⁹², Dieter Proch⁴⁷,
 Avinash Puntambekar¹⁸⁹, Qing Qin⁸⁷, Hua Min Qu⁸⁷, Arnulf Quadt⁵⁸,
 Jean-Pierre Quesnel³⁵, Veljko Radeka¹⁹, Rahmat Rahmat²⁷⁵, Santosh Kumar Rai²⁵⁸,
 Pantaleo Raimondi¹³⁴, Erik Ramberg⁵⁴, Kirti Ranjan²⁴⁸, Sista V.L.S. Rao¹³,
 Alexei Raspereza¹⁴⁷, Alessandro Ratti¹³⁷, Lodovico Ratti^{278,101}, Tor Raubenheimer²⁰³,
 Ludovic Raux¹³⁰, V. Ravindran⁶⁴, Sreerup Raychaudhuri^{77,211}, Valerio Re^{307,101},
 Bill Rease¹⁴², Charles E. Reece²²⁰, Meinhard Regler¹⁷⁷, Kay Rehlich⁴⁷, Ina Reichel¹³⁷,
 Armin Reichold²⁷⁶, John Reid⁵⁴, Ron Reid^{38,26}, James Reidy²⁷⁰, Marcel Reinhard⁵⁰,
 Uwe Renz⁴, Jose Repond⁸, Javier Resta-Lopez²⁷⁶, Lars Reuen³⁰³, Jacob Ribnik²⁴³,
 Tyler Rice²⁴⁴, François Richard¹³⁰, Sabine Riemann⁴⁸, Tord Riemann⁴⁸, Keith Riles²⁶⁸,
 Daniel Riley⁴³, Cécile Rimbault¹³⁰, Saurabh Rindani¹⁸¹, Louis Rinolfi³⁵, Fabio Risigo⁹⁶,
 Imma Riu²²⁹, Dmitri Rizhikov¹⁷⁴, Thomas Rizzo²⁰³, James H. Rochford²⁷,
 Ponciano Rodriguez²⁰³, Martin Roeben¹³⁸, Gigi Rolandi³⁵, Aaron Roodman²⁰³,
 Eli Rosenberg¹⁰⁷, Robert Roser⁵⁴, Marc Ross⁵⁴, François Rossel³⁰², Robert Rossmanith⁷,
 Stefan Roth¹⁹⁰, André Rouge⁵⁰, Allan Rowe⁵⁴, Amit Roy¹⁰⁵, Sendhunil B. Roy¹⁸⁹,
 Sourov Roy⁷³, Laurent Royer¹³¹, Perrine Royole-Degieux^{130,59}, Christophe Royon²⁸,
 Manqi Ruan³¹, David Rubin⁴³, Ingo Ruehl³⁵, Alberto Ruiz Jimeno⁹⁵, Robert Ruland²⁰³,
 Brian Rusnak¹³⁸, Sun-Young Ryu¹⁸⁷, Gian Luca Sabbi¹³⁷, Iftach Sadeh²¹⁶,
 Ziraddin Y Sadygov¹¹⁵, Takayuki Saeki⁶⁷, David Sagan⁴³, Vinod C. Sahn^{189,13},
 Arun Saini²⁴⁸, Kenji Saito⁶⁷, Kiwamu Saito⁶⁷, Gerard Sajot¹³², Shogo Sakanaka⁶⁷,
 Kazuyuki Sakaue³²⁰, Zen Salata²⁰³, Sabah Salih²⁶⁵, Fabrizio Salvatore¹⁹²,
 Joergen Samson⁴⁷, Toshiya Sanami⁶⁷, Allister Levi Sanchez⁵⁰, William Sands¹⁸⁵,

John Santic^{54,*}, Tomoyuki Sanuki²²², Andrey Sapronov^{115,48}, Utpal Sarkar¹⁸¹,
 Noboru Sasao¹²⁶, Kotaro Satoh⁶⁷, Fabio Sauli³⁵, Claude Saunders⁸, Valeri Saveliev¹⁷⁴,
 Aurore Savoy-Navarro³⁰², Lee Sawyer¹⁴³, Laura Saxton¹⁵⁰, Oliver Schäfer³⁰⁵,
 Andreas Schällicke⁴⁸, Peter Schade^{47,255}, Sebastien Schaetzel⁴⁷, Glenn Scheitrum²⁰³,
 Émilie Schibler²⁹⁹, Rafe Schindler²⁰³, Markus Schlösser⁴⁷, Ross D. Schlueter¹³⁷,
 Peter Schmid⁴⁸, Ringo Sebastian Schmidt^{48,17}, Uwe Schneekloth⁴⁷,
 Heinz Juergen Schreiber⁴⁸, Siegfried Schreiber⁴⁷, Henning Schroeder³⁰⁵, K. Peter Schüler⁴⁷,
 Daniel Schulte³⁵, Hans-Christian Schultz-Coulon²⁵⁷, Markus Schumacher³⁰⁶,
 Steffen Schumann²¹⁵, Bruce A. Schumm^{244,245}, Reinhard Schwienhorst¹⁵⁰,
 Rainer Schwierz²¹⁴, Duncan J. Scott^{38,26}, Fabrizio Scuri¹⁰², Felix Sefkow⁴⁷, Rachid Sefri⁸³,
 Nathalie Seguin-Moreau¹³⁰, Sally Seidel²⁷², David Seidman¹⁷², Sezen Sekmen¹⁵¹,
 Sergei Seletskiy²⁰³, Eibun Senaha¹⁵⁹, Rohan Senanayake²⁷⁶, Hiroshi Sendai⁶⁷,
 Daniele Sertore⁹⁶, Andrei Seryi²⁰³, Ronald Settles^{147,47}, Ramazan Sever¹⁵¹,
 Nicholas Shales^{38,136}, Ming Shao²⁸³, G. A. Shelkov¹¹⁵, Ken Shepard⁸,
 Claire Shepherd-Themistocleous²⁷, John C. Sheppard²⁰³, Cai Tu Shi⁸⁷, Tetsuo Shidara⁶⁷,
 Yeo-Jeong Shim¹⁸⁷, Hirotaka Shimizu⁶⁸, Yasuhiro Shimizu¹²³, Yuuki Shimizu¹⁹³,
 Tetsushi Shimogawa¹⁹³, Seunghwan Shin³⁰, Masaomi Shioden⁷¹, Ian Shipsey¹⁸⁶,
 Grigori Shirkov¹¹⁵, Toshio Shishido⁶⁷, Ram K. Shivpuri²⁴⁸, Purushottam Shrivastava¹⁸⁹,
 Sergey Shulga^{115,60}, Nikolai Shumeiko¹¹, Sergey Shuvalov⁴⁷, Zongguo Si¹⁹⁸,
 Azher Majid Siddiqui¹¹⁰, James Siegrist^{137,239}, Claire Simon²⁸, Stefan Simrock⁴⁷,
 Nikolai Sinev²⁷⁵, Bhartendu K. Singh¹², Jasbir Singh¹⁷⁸, Pitamber Singh¹³, R.K. Singh¹²⁹,
 S.K. Singh⁵, Monito Singini²⁷⁸, Anil K. Sinha¹³, Nita Sinha⁸⁸, Rahul Sinha⁸⁸,
 Klaus Sinram⁴⁷, A. N. Sissakian¹¹⁵, N. B. Skachkov¹¹⁵, Alexander Skrinsky²¹,
 Mark Slater²⁴⁶, Wojciech Slominski¹⁰⁸, Ivan Smiljanic³¹⁶, A J Stewart Smith¹⁸⁵,
 Alex Smith²⁶⁹, Brian J. Smith²⁷, Jeff Smith^{43,203}, Jonathan Smith^{38,136}, Steve Smith²⁰³,
 Susan Smith^{38,26}, Tonee Smith²⁰³, W. Neville Snodgrass²⁶, Blanka Sobloher⁴⁷,
 Young-Uk Sohn¹⁸², Ruelson Solidum^{153,152}, Nikolai Solyak⁵⁴, Dongchul Son³⁰,
 Nasuf Sonmez⁵¹, Andre Sopczak^{38,136}, V. Soskov¹³⁹, Cherrill M. Spencer²⁰³,
 Panagiotis Spentzouris⁵⁴, Valeria Speziali²⁷⁸, Michael Spira²⁰⁹, Daryl Sprehn²⁰³,
 K. Sridhar²¹¹, Asutosh Srivastava^{248,14}, Steve St. Lorant²⁰³, Achim Stahl¹⁹⁰,
 Richard P. Stanek⁵⁴, Marcel Stanitzki²⁷, Jacob Stanley^{245,244}, Konstantin Stefanov²⁷,
 Werner Stein¹³⁸, Herbert Steiner¹³⁷, Evert Stenlund¹⁴⁵, Amir Stern²¹⁶, Matt Sternberg²⁷⁵,
 Dominik Stockinger²⁵⁴, Mark Stockton²³⁶, Holger Stoeck²⁸⁷, John Strachan²⁶,
 V. Strakhovenko²¹, Michael Strauss²⁷⁴, Sergei I. Striganov⁵⁴, John Strologas²⁷²,
 David Strom²⁷⁵, Jan Strube²⁷⁵, Gennady Stupakov²⁰³, Dong Su²⁰³, Yuji Sudo²⁹²,
 Taikan Suehara²⁹⁰, Toru Suehiro²⁹⁰, Yusuke Suetsugu⁶⁷, Ryuhei Sugahara⁶⁷,
 Yasuhiro Sugimoto⁶⁷, Akira Sugiyama¹⁹³, Jun Suhk Suh³⁰, Goran Sukovic²⁷¹, Hong Sun⁸⁷,
 Stephen Sun²⁰³, Werner Sun⁴³, Yi Sun⁸⁷, Yipeng Sun^{87,10}, Leszek Suszycki³,
 Peter Sutcliffe^{38,263}, Rameshwar L. Suthar¹³, Tsuyoshi Suwada⁶⁷, Atsuto Suzuki⁶⁷,
 Chihiro Suzuki¹⁵⁵, Shiro Suzuki¹⁹³, Takashi Suzuki²⁹², Richard Swent²⁰³,
 Krzysztof Swientek³, Christina Swinson²⁷⁶, Evgeny Syresin¹¹⁵, Michal Szleper¹⁷²,
 Alexander Tadday²⁵⁷, Rika Takahashi^{67,59}, Tohru Takahashi⁶⁸, Mikio Takano¹⁹⁶,
 Fumihiko Takasaki⁶⁷, Seishi Takeda⁶⁷, Tateru Takenaka⁶⁷, Tohru Takeshita²⁰⁰,
 Yosuke Takubo²²², Masami Tanaka⁶⁷, Chuan Xiang Tang³¹, Takashi Taniguchi⁶⁷,
 Sami Tantawi²⁰³, Stefan Tapprogge¹¹³, Michael A. Tartaglia⁵⁴,
 Giovanni Francesco Tassielli³¹³, Toshiaki Tauchi⁶⁷, Laurent Tavian³⁵, Hiroko Tawara⁶⁷,
 Geoffrey Taylor²⁶⁷, Alexandre V. Telnov¹⁸⁵, Valery Telnov²¹, Peter Tenenbaum²⁰³,

Eliza Teodorescu², Akio Terashima⁶⁷, Giuseppina Terracciano⁹⁹, Nobuhiro Terunuma⁶⁷,
 Thomas Teubner²⁶³, Richard Teuscher^{293,291}, Jay Theilacker⁵⁴, Mark Thomson²⁴⁶,
 Jeff Tice²⁰³, Maury Tigner⁴³, Jan Timmermans¹⁶⁰, Maxim Titov²⁸, Nobukazu Toge⁶⁷,
 N. A. Tokareva¹¹⁵, Kirsten Tollefson¹⁵⁰, Lukas Tomasek⁹⁰, Savo Tomovic²⁷¹,
 John Tompkins⁵⁴, Manfred Tonutti¹⁹⁰, Anita Topkar¹³, Dragan Toprek^{38,265},
 Fernando Toral³³, Eric Torrence²⁷⁵, Gianluca Traversi^{307,101}, Marcel Trimpl⁵⁴,
 S. Mani Tripathi²⁴⁰, William Trischuk²⁹¹, Mark Trodden²¹⁰, G. V. Trubnikov¹¹⁵,
 Robert Tschirhart⁵⁴, Edisher Tskhadadze¹¹⁵, Kiyosumi Tsuchiya⁶⁷,
 Toshifumi Tsukamoto⁶⁷, Akira Tsunemi²⁰⁷, Robin Tucker^{38,136}, Renato Turchetta²⁷,
 Mike Tyndel²⁷, Nobuhiro Uekusa^{258,65}, Kenji Ueno⁶⁷, Kensei Umemori⁶⁷,
 Martin Ummenhofer³⁰³, David Underwood⁸, Satoru Uozumi²⁰⁰, Junji Urakawa⁶⁷,
 Jeremy Urban⁴³, Didier Uriot²⁸, David Urner²⁷⁶, Andrei Ushakov⁴⁸, Tracy Usher²⁰³,
 Sergey Uzunyan¹⁷¹, Brigitte Vachon¹⁴⁸, Linda Valerio⁵⁴, Isabelle Valin⁸⁴, Alex Valishev⁵⁴,
 Raghava Vamra⁷⁵, Harry Van Der Graaf^{160,35}, Rick Van Kooten⁷⁹, Gary Van Zandbergen⁵⁴,
 Jean-Charles Vanel⁵⁰, Alessandro Variola¹³⁰, Gary Varner²⁵⁶, Mayda Velasco¹⁷²,
 Ulrich Velte⁴⁷, Jaap Velthuis²³⁷, Sundir K. Vempati⁷⁴, Marco Venturini¹³⁷,
 Christophe Vescovi¹³², Henri Videau⁵⁰, Ivan Vila⁹⁵, Pascal Vincent³⁰², Jean-Marc Virey³²,
 Bernard Visentin²⁸, Michele Viti⁴⁸, Thanh Cuong Vo³¹⁷, Adrian Vogel⁴⁷, Harald Vogt⁴⁸,
 Eckhard Von Toerne^{303,116}, S. B. Vorozhtsov¹¹⁵, Marcel Vos⁹⁴, Margaret Votava⁵⁴,
 Vaclav Vrba⁹⁰, Doreen Wackerroth²⁰⁵, Albrecht Wagner⁴⁷, Carlos E. M. Wagner^{8,52},
 Stephen Wagner²⁴⁷, Masayoshi Wake⁶⁷, Roman Walczak²⁷⁶, Nicholas J. Walker⁴⁷,
 Wolfgang Walkowiak³⁰⁶, Samuel Wallon¹³³, Roberval Walsh²⁵¹, Sean Walston¹³⁸,
 Wolfgang Waltenberger¹⁷⁷, Dieter Walz²⁰³, Chao En Wang¹⁶³, Chun Hong Wang⁸⁷,
 Dou Wang⁸⁷, Faya Wang²⁰³, Guang Wei Wang⁸⁷, Haitao Wang⁸, Jiang Wang⁸⁷,
 Jiu Qing Wang⁸⁷, Juwen Wang²⁰³, Lanfa Wang²⁰³, Lei Wang²⁴⁴, Min-Zu Wang¹⁶⁴,
 Qing Wang³¹, Shu Hong Wang⁸⁷, Xiaolian Wang²⁸³, Xue-Lei Wang⁶⁶, Yi Fang Wang⁸⁷,
 Zheng Wang⁸⁷, Rainer Wanzenberg⁴⁷, Bennie Ward⁹, David Ward²⁴⁶,
 Barbara Warmbein^{47,59}, David W. Warner⁴⁰, Matthew Warren²³⁰, Masakazu Washio³²⁰,
 Isamu Watanabe¹⁶⁹, Ken Watanabe⁶⁷, Takashi Watanabe¹²¹, Yuichi Watanabe⁶⁷,
 Nigel Watson²³⁶, Nanda Wattimena^{47,255}, Mitchell Wayne²⁷³, Marc Weber²⁷,
 Harry Weerts⁸, Georg Weiglein⁴⁹, Thomas Weiland⁸², Stefan Weinzierl¹¹³, Hans Weise⁴⁷,
 John Weisend²⁰³, Manfred Wendt⁵⁴, Oliver Wendt^{47,255}, Hans Wenzel⁵⁴,
 William A. Wenzel¹³⁷, Norbert Wermes³⁰³, Ulrich Werthenbach³⁰⁶, Steve Wesseln⁵⁴,
 William Wester⁵⁴, Andy White²⁸⁸, Glen R. White²⁰³, Katarzyna Wichmann⁴⁷,
 Peter Wienemann³⁰³, Wojciech Wierba²¹⁹, Tim Wilksen⁴³, William Willis⁴¹,
 Graham W. Wilson²⁶², John A. Wilson²³⁶, Robert Wilson⁴⁰, Matthew Wing²³⁰,
 Marc Winter⁸⁴, Brian D. Wirth²³⁹, Stephen A. Wolbers⁵⁴, Dan Wolff⁵⁴,
 Andrzej Wolski^{38,263}, Mark D. Woodley²⁰³, Michael Woods²⁰³, Michael L. Woodward²⁷,
 Timothy Woolliscroft^{263,27}, Steven Worm²⁷, Guy Wormser¹³⁰, Dennis Wright²⁰³,
 Douglas Wright¹³⁸, Andy Wu²²⁰, Tao Wu¹⁹², Yue Liang Wu⁹³, Stefania Xella¹⁶⁵,
 Guoxing Xia⁴⁷, Lei Xia⁸, Aimin Xiao⁸, Liling Xiao²⁰³, Jia Lin Xie⁸⁷, Zhi-Zhong Xing⁸⁷,
 Lian You Xiong²¹², Gang Xu⁸⁷, Qing Jing Xu⁸⁷, Urjit A. Yajnik⁷⁵, Vitaly Yakimenko¹⁹,
 Ryuji Yamada⁵⁴, Hiroshi Yamaguchi¹⁹³, Akira Yamamoto⁶⁷, Hitoshi Yamamoto²²²,
 Masahiro Yamamoto¹⁵⁵, Naoto Yamamoto¹⁵⁵, Richard Yamamoto¹⁴⁶,
 Yasuchika Yamamoto⁶⁷, Takashi Yamanaka²⁹⁰, Hiroshi Yamaoka⁶⁷, Satoru Yamashita¹⁰⁶,
 Hideki Yamazaki²⁹², Wenbiao Yan²⁴⁶, Hai-Jun Yang²⁶⁸, Jin Min Yang⁹³, Jongmann Yang⁵³,
 Zhenwei Yang³¹, Yoshiharu Yano⁶⁷, Efe Yazgan^{218,35}, G. P. Yeh⁵⁴, Hakan Yilmaz⁷²,

Philip Yock²³⁴, Hakutaro Yoda²⁹⁰, John Yoh⁵⁴, Kaoru Yokoya⁶⁷, Hirokazu Yokoyama¹²⁶,
Richard C. York¹⁵⁰, Mitsuhiro Yoshida⁶⁷, Takuo Yoshida⁵⁷, Tamaki Yoshioka¹⁰⁶,
Andrew Young²⁰³, Cheng Hui Yu⁸⁷, Jaehoon Yu²⁸⁸, Xian Ming Yu⁸⁷, Changzheng Yuan⁸⁷,
Chong-Xing Yue¹⁴⁰, Jun Hui Yue⁸⁷, Josef Zacek³⁶, Igor Zagorodnov⁴⁷, Jaroslav Zalesak⁹⁰,
Boris Zalikhanov¹¹⁵, Aleksander Filip Zarnecki²⁹⁴, Leszek Zawiejski²¹⁹,
Christian Zeitnitz²⁹⁸, Michael Zeller³²³, Dirk Zerwas¹³⁰, Peter Zerwas^{47,190},
Mehmet Zeyrek¹⁵¹, Ji Yuan Zhai⁸⁷, Bao Cheng Zhang¹⁰, Bin Zhang³¹, Chuang Zhang⁸⁷,
He Zhang⁸⁷, Jiawen Zhang⁸⁷, Jing Zhang⁸⁷, Jing Ru Zhang⁸⁷, Jinlong Zhang⁸,
Liang Zhang²¹², X. Zhang⁸⁷, Yuan Zhang⁸⁷, Zhige Zhang²⁷, Zhiqing Zhang¹³⁰,
Ziping Zhang²⁸³, Haiwen Zhao²⁷⁰, Ji Jiu Zhao⁸⁷, Jing Xia Zhao⁸⁷, Ming Hua Zhao¹⁹⁹,
Sheng Chu Zhao⁸⁷, Tianchi Zhao²⁹⁶, Tong Xian Zhao²¹², Zhen Tang Zhao¹⁹⁹,
Zhengguo Zhao^{268,283}, De Min Zhou⁸⁷, Feng Zhou²⁰³, Shun Zhou⁸⁷, Shou Hua Zhu¹⁰,
Xiong Wei Zhu⁸⁷, Valery Zhukov³⁰⁴, Frank Zimmermann³⁵, Michael Ziolkowski³⁰⁶,
Michael S. Zisman¹³⁷, Fabian Zomer¹³⁰, Zhang Guo Zong⁸⁷, Osman Zorba⁷²,
Vishnu Zutshi¹⁷¹

List of Institutions

- ¹ *Abdus Salam International Centre for Theoretical Physics, Strada Costiera 11, 34014 Trieste, Italy*
- ² *Academy, RPR, National Institute of Physics and Nuclear Engineering ‘Horia Hulubei’ (IFIN-HH), Str. Atomistilor no. 407, P.O. Box MG-6, R-76900 Bucharest - Magurele, Romania*
- ³ *AGH University of Science and Technology Akademia Gorniczo-Hutnicza im. Stanislaw Staszica w Krakowie al. Mickiewicza 30 PL-30-059 Cracow, Poland*
- ⁴ *Albert-Ludwigs Universität Freiburg, Physikalisches Institut, Hermann-Herder Str. 3, D-79104 Freiburg, Germany*
- ⁵ *Aligarh Muslim University, Aligarh, Uttar Pradesh 202002, India*
- ⁶ *Amberg Engineering AG, Trockenloostr. 21, P.O.Box 27, 8105 Regensdorf-Watt, Switzerland*
- ⁷ *Angstromquelle Karlsruhe (ANKA), Forschungszentrum Karlsruhe, Hermann-von-Helmholtz-Platz 1, D-76344 Eggenstein-Leopoldshafen, Germany*
- ⁸ *Argonne National Laboratory (ANL), 9700 S. Cass Avenue, Argonne, IL 60439, USA*
- ⁹ *Baylor University, Department of Physics, 101 Bagby Avenue, Waco, TX 76706, USA*
- ¹⁰ *Beijing University, Department of Physics, Beijing, China 100871*
- ¹¹ *Belarusian State University, National Scientific & Educational Center, Particle & HEP Physics, M. Bogdanovich St., 153, 240040 Minsk, Belarus*
- ¹² *Benares Hindu University, Benares, Varanasi 221005, India*
- ¹³ *Bhabha Atomic Research Centre, Trombay, Mumbai 400085, India*
- ¹⁴ *Birla Institute of Technology and Science, EEE Dept., Pilani, Rajasthan, India*
- ¹⁵ *Bogazici University, Physics Department, 34342 Bebek / Istanbul, 80820 Istanbul, Turkey*
- ¹⁶ *Boston University, Department of Physics, 590 Commonwealth Avenue, Boston, MA 02215, USA*
- ¹⁷ *Brandenburg University of Technology, Postfach 101344, D-03013 Cottbus, Germany*
- ¹⁸ *Brno University of Technology, Antonínská; 548/1, CZ 601 90 Brno, Czech Republic*
- ¹⁹ *Brookhaven National Laboratory (BNL), P.O.Box 5000, Upton, NY 11973-5000, USA*
- ²⁰ *Brown University, Department of Physics, Box 1843, Providence, RI 02912, USA*
- ²¹ *Budkar Institute for Nuclear Physics (BINP), 630090 Novosibirsk, Russia*
- ²² *Calcutta University, Department of Physics, 92 A.P.C. Road, Kolkata 700009, India*
- ²³ *California Institute of Technology, Physics, Mathematics and Astronomy (PMA), 1200 East California Blvd, Pasadena, CA 91125, USA*
- ²⁴ *Carleton University, Department of Physics, 1125 Colonel By Drive, Ottawa, Ontario, Canada K1S 5B6*

- ²⁵ Carnegie Mellon University, Department of Physics, Wean Hall 7235, Pittsburgh, PA 15213, USA
- ²⁶ CCLRC Daresbury Laboratory, Daresbury, Warrington, Cheshire WA4 4AD, UK
- ²⁷ CCLRC Rutherford Appleton Laboratory, Chilton, Didcot, Oxton OX11 0QX, UK
- ²⁸ CEA Saclay, DAPNIA, F-91191 Gif-sur-Yvette, France
- ²⁹ CEA Saclay, Service de Physique Théorique, CEA/DSM/SPhT, F-91191 Gif-sur-Yvette Cedex, France
- ³⁰ Center for High Energy Physics (CHEP) / Kyungpook National University, 1370 Sankyuk-dong, Buk-gu, Daegu 702-701, Korea
- ³¹ Center for High Energy Physics (TUHEP), Tsinghua University, Beijing, China 100084
- ³² Centre de Physique Theorique, CNRS - Luminy, Universiti d'Aix - Marseille II, Campus of Luminy, Case 907, 13288 Marseille Cedex 9, France
- ³³ Centro de Investigaciones Energéticas, Medioambientales y Tecnológicas, CIEMAT, Avenia Complutense 22, E-28040 Madrid, Spain
- ³⁴ Centro Nacional de Microelectrónica (CNM), Instituto de Microelectrónica de Barcelona (IMB), Campus UAB, 08193 Cerdanyola del Vallès (Bellaterra), Barcelona, Spain
- ³⁵ CERN, CH-1211 Genève 23, Switzerland
- ³⁶ Charles University, Institute of Particle & Nuclear Physics, Faculty of Mathematics and Physics, V Holesovickach 2, CZ-18000 Praque 8, Czech Republic
- ³⁷ Chonbuk National University, Physics Department, Chonju 561-756, Korea
- ³⁸ Cockcroft Institute, Daresbury, Warrington WA4 4AD, UK
- ³⁹ College of William and Mary, Department of Physics, Williamsburg, VA, 23187, USA
- ⁴⁰ Colorado State University, Department of Physics, Fort Collins, CO 80523, USA
- ⁴¹ Columbia University, Department of Physics, New York, NY 10027-6902, USA
- ⁴² Concordia University, Department of Physics, 1455 De Maisonneuve Blvd. West, Montreal, Quebec, Canada H3G 1M8
- ⁴³ Cornell University, Laboratory for Elementary-Particle Physics (LEPP), Ithaca, NY 14853, USA
- ⁴⁴ Cukurova University, Department of Physics, Fen-Ed. Fakultesi 01330, Balcali, Turkey
- ⁴⁵ D. V. Efremov Research Institute, SINTEZ, 196641 St. Petersburg, Russia
- ⁴⁶ Dartmouth College, Department of Physics and Astronomy, 6127 Wilder Laboratory, Hanover, NH 03755, USA
- ⁴⁷ DESY-Hamburg site, Deutsches Elektronen-Synchrotron in der Helmholtz-Gemeinschaft, Notkestrasse 85, 22607 Hamburg, Germany
- ⁴⁸ DESY-Zeuthen site, Deutsches Elektronen-Synchrotron in der Helmholtz-Gemeinschaft, Platanenallee 6, D-15738 Zeuthen, Germany
- ⁴⁹ Durham University, Department of Physics, Ogen Center for Fundamental Physics, South Rd., Durham DH1 3LE, UK
- ⁵⁰ Ecole Polytechnique, Laboratoire Leprince-Ringuet (LLR), Route de Saclay, F-91128 Palaiseau Cedex, France
- ⁵¹ Ege University, Department of Physics, Faculty of Science, 35100 Izmir, Turkey
- ⁵² Enrico Fermi Institute, University of Chicago, 5640 S. Ellis Avenue, RI-183, Chicago, IL 60637, USA
- ⁵³ Ewha Womans University, 11-1 Daehyun-Dong, Seodaemun-Gu, Seoul, 120-750, Korea
- ⁵⁴ Fermi National Accelerator Laboratory (FNAL), P.O.Box 500, Batavia, IL 60510-0500, USA
- ⁵⁵ Fujita Gakuen Health University, Department of Physics, Toyoake, Aichi 470-1192, Japan

- ⁵⁶ Fukui University of Technology, 3-6-1 Gakuen, Fukui-shi, Fukui 910-8505, Japan
- ⁵⁷ Fukui University, Department of Physics, 3-9-1 Bunkyo, Fukui-shi, Fukui 910-8507, Japan
- ⁵⁸ Georg-August-Universität Göttingen, II. Physikalisches Institut, Friedrich-Hund-Platz 1,
37077 Göttingen, Germany
- ⁵⁹ Global Design Effort
- ⁶⁰ Gomel State University, Department of Physics, Ul. Sovietskaya 104, 246699 Gomel,
Belarus
- ⁶¹ Guangxi University, College of Physics science and Engineering Technology, Nanning,
China 530004
- ⁶² Hanoi University of Technology, 1 Dai Co Viet road, Hanoi, Vietnam
- ⁶³ Hanson Professional Services, Inc., 1525 S. Sixth St., Springfield, IL 62703, USA
- ⁶⁴ Harish-Chandra Research Institute, Chhatnag Road, Jhusi, Allahabad 211019, India
- ⁶⁵ Helsinki Institute of Physics (HIP), P.O. Box 64, FIN-00014 University of Helsinki,
Finland
- ⁶⁶ Henan Normal University, College of Physics and Information Engineering, Xinxiang,
China 453007
- ⁶⁷ High Energy Accelerator Research Organization, KEK, 1-1 Oho, Tsukuba, Ibaraki
305-0801, Japan
- ⁶⁸ Hiroshima University, Department of Physics, 1-3-1 Kagamiyama, Higashi-Hiroshima,
Hiroshima 739-8526, Japan
- ⁶⁹ Humboldt Universität zu Berlin, Fachbereich Physik, Institut für
Elementarteilchenphysik, Newtonstr. 15, D-12489 Berlin, Germany
- ⁷⁰ Hungarian Academy of Sciences, KFKI Research Institute for Particle and Nuclear
Physics, P.O. Box 49, H-1525 Budapest, Hungary
- ⁷¹ Ibaraki University, College of Technology, Department of Physics, Nakanarusawa 4-12-1,
Hitachi, Ibaraki 316-8511, Japan
- ⁷² Imperial College, Blackett Laboratory, Department of Physics, Prince Consort Road,
London, SW7 2BW, UK
- ⁷³ Indian Association for the Cultivation of Science, Department of Theoretical Physics and
Centre for Theoretical Sciences, Kolkata 700032, India
- ⁷⁴ Indian Institute of Science, Centre for High Energy Physics, Bangalore 560012,
Karnataka, India
- ⁷⁵ Indian Institute of Technology, Bombay, Powai, Mumbai 400076, India
- ⁷⁶ Indian Institute of Technology, Guwahati, Guwahati, Assam 781039, India
- ⁷⁷ Indian Institute of Technology, Kanpur, Department of Physics, IIT Post Office, Kanpur
208016, India
- ⁷⁸ Indiana University - Purdue University, Indianapolis, Department of Physics, 402 N.
Blackford St., LD 154, Indianapolis, IN 46202, USA
- ⁷⁹ Indiana University, Department of Physics, Swain Hall West 117, 727 E. 3rd St.,
Bloomington, IN 47405-7105, USA
- ⁸⁰ Institutio Catalana de Recerca i Estudis, ICREA, Passeig Lluís Companys, 23, Barcelona
08010, Spain
- ⁸¹ Institut de Physique Nucléaire, F-91406 Orsay, France
- ⁸² Institut für Theorie Elektromagnetischer Felder (TEMF), Technische Universität
Darmstadt, Schloßgartenstr. 8, D-64289 Darmstadt, Germany
- ⁸³ Institut National de Physique Nucleaire et de Physique des Particules, 3, Rue Michel-
Ange, 75794 Paris Cedex 16, France

- ⁸⁴ *Institut Pluridisciplinaire Hubert Curien, 23 Rue du Loess - BP28, 67037 Strasbourg Cedex 2, France*
- ⁸⁵ *Institute for Chemical Research, Kyoto University, Gokasho, Uji, Kyoto 611-0011, Japan*
- ⁸⁶ *Institute for Cosmic Ray Research, University of Tokyo, 5-1-5 Kashiwa-no-Ha, Kashiwa, Chiba 277-8582, Japan*
- ⁸⁷ *Institute of High Energy Physics - IHEP, Chinese Academy of Sciences, P.O. Box 918, Beijing, China 100049*
- ⁸⁸ *Institute of Mathematical Sciences, Taramani, C.I.T. Campus, Chennai 600113, India*
- ⁸⁹ *Institute of Physics and Electronics, Vietnamese Academy of Science and Technology (VAST), 10 Dao-Tan, Ba-Dinh, Hanoi 10000, Vietnam*
- ⁹⁰ *Institute of Physics, ASCR, Academy of Science of the Czech Republic, Division of Elementary Particle Physics, Na Slovance 2, CS-18221 Prague 8, Czech Republic*
- ⁹¹ *Institute of Physics, Pomorska 149/153, PL-90-236 Lodz, Poland*
- ⁹² *Institute of Theoretical and Experimental Physics, B. Chermushkinskawa, 25, RU-117259, Moscow, Russia*
- ⁹³ *Institute of Theoretical Physics, Chinese Academy of Sciences, P.O.Box 2735, Beijing, China 100080*
- ⁹⁴ *Instituto de Fisica Corpuscular (IFIC), Centro Mixto CSIC-UVEG, Edificio Investigacion Paterna, Apartado 22085, 46071 Valencia, Spain*
- ⁹⁵ *Instituto de Fisica de Cantabria, (IFCA, CSIC-UC), Facultad de Ciencias, Avda. Los Castros s/n, 39005 Santander, Spain*
- ⁹⁶ *Instituto Nazionale di Fisica Nucleare (INFN), Laboratorio LASA, Via Fratelli Cervi 201, 20090 Segrate, Italy*
- ⁹⁷ *Instituto Nazionale di Fisica Nucleare (INFN), Sezione di Ferrara, via Paradiso 12, I-44100 Ferrara, Italy*
- ⁹⁸ *Instituto Nazionale di Fisica Nucleare (INFN), Sezione di Firenze, Via G. Sansone 1, I-50019 Sesto Fiorentino (Firenze), Italy*
- ⁹⁹ *Instituto Nazionale di Fisica Nucleare (INFN), Sezione di Lecce, via Arnesano, I-73100 Lecce, Italy*
- ¹⁰⁰ *Instituto Nazionale di Fisica Nucleare (INFN), Sezione di Napoli, Complesso Università di Monte Sant'Angelo, via, I-80126 Naples, Italy*
- ¹⁰¹ *Instituto Nazionale di Fisica Nucleare (INFN), Sezione di Pavia, Via Bassi 6, I-27100 Pavia, Italy*
- ¹⁰² *Instituto Nazionale di Fisica Nucleare (INFN), Sezione di Pisa, Edificio C - Polo Fibonacci Largo B. Pontecorvo, 3, I-56127 Pisa, Italy*
- ¹⁰³ *Instituto Nazionale di Fisica Nucleare (INFN), Sezione di Torino, c/o Università' di Torino facoltà' di Fisica, via P Giuria 1, 10125 Torino, Italy*
- ¹⁰⁴ *Instituto Nazionale di Fisica Nucleare (INFN), Sezione di Trieste, Padriciano 99, I-34012 Trieste (Padriciano), Italy*
- ¹⁰⁵ *Inter-University Accelerator Centre, Aruna Asaf Ali Marg, Post Box 10502, New Delhi 110067, India*
- ¹⁰⁶ *International Center for Elementary Particle Physics, University of Tokyo, Hongo 7-3-1, Bunkyo District, Tokyo 113-0033, Japan*
- ¹⁰⁷ *Iowa State University, Department of Physics, High Energy Physics Group, Ames, IA 50011, USA*
- ¹⁰⁸ *Jagiellonian University, Institute of Physics, Ul. Reymonta 4, PL-30-059 Cracow, Poland*

- ¹⁰⁹ *Jamia Millia Islamia, Centre for Theoretical Physics, Jamia Nagar, New Delhi 110025, India*
- ¹¹⁰ *Jamia Millia Islamia, Department of Physics, Jamia Nagar, New Delhi 110025, India*
- ¹¹¹ *Japan Aerospace Exploration Agency, Sagamihara Campus, 3-1-1 Yoshinodai, Sagamihara, Kanagawa 220-8510, Japan*
- ¹¹² *Japan Atomic Energy Agency, 4-49 Muramatsu, Tokai-mura, Naka-gun, Ibaraki 319-1184, Japan*
- ¹¹³ *Johannes Gutenberg Universität Mainz, Institut für Physik, 55099 Mainz, Germany*
- ¹¹⁴ *Johns Hopkins University, Applied Physics Laboratory, 11100 Johns Hopkins RD., Laurel, MD 20723-6099, USA*
- ¹¹⁵ *Joint Institute for Nuclear Research (JINR), Joliot-Curie 6, 141980, Dubna, Moscow Region, Russia*
- ¹¹⁶ *Kansas State University, Department of Physics, 116 Cardwell Hall, Manhattan, KS 66506, USA*
- ¹¹⁷ *KCS Corp., 2-7-25 Muramatsukita, Tokai, Ibaraki 319-1108, Japan*
- ¹¹⁸ *Kharkov Institute of Physics and Technology, National Science Center, 1, Akademicheskaya St., Kharkov, 61108, Ukraine*
- ¹¹⁹ *Kinki University, Department of Physics, 3-4-1 Kowakae, Higashi-Osaka, Osaka 577-8502, Japan*
- ¹²⁰ *Kobe University, Faculty of Science, 1-1 Rokkodai-cho, Nada-ku, Kobe, Hyogo 657-8501, Japan*
- ¹²¹ *Kogakuin University, Department of Physics, Shinjuku Campus, 1-24-2 Nishi-Shinjuku, Shinjuku-ku, Tokyo 163-8677, Japan*
- ¹²² *Konkuk University, 93-1 Mojin-dong, Kwanglin-gu, Seoul 143-701, Korea*
- ¹²³ *Korea Advanced Institute of Science & Technology, Department of Physics, 373-1 Kusong-dong, Yusong-gu, Taejon 305-701, Korea*
- ¹²⁴ *Korea Institute for Advanced Study (KIAS), School of Physics, 207-43 Cheongryangri-dong, Dongdaemun-gu, Seoul 130-012, Korea*
- ¹²⁵ *Korea University, Department of Physics, Seoul 136-701, Korea*
- ¹²⁶ *Kyoto University, Department of Physics, Kitashirakawa-Oiwakecho, Sakyo-ku, Kyoto 606-8502, Japan*
- ¹²⁷ *L.P.T.A., UMR 5207 CNRS-UM2, Université Montpellier II, Case Courrier 070, Bât. 13, place Eugène Bataillon, 34095 Montpellier Cedex 5, France*
- ¹²⁸ *Laboratoire d'Annecy-le-Vieux de Physique des Particules (LAPP), Chemin de Bellevue, BP 110, F-74941 Annecy-le-Vieux Cedex, France*
- ¹²⁹ *Laboratoire d'Annecy-le-Vieux de Physique Theorique (LAPTH), Chemin de Bellevue, BP 110, F-74941 Annecy-le-Vieux Cedex, France*
- ¹³⁰ *Laboratoire de l'Accélérateur Linéaire (LAL), Université Paris-Sud 11, Bâtiment 200, 91898 Orsay, France*
- ¹³¹ *Laboratoire de Physique Corpusculaire de Clermont-Ferrand (LPC), Université Blaise Pascal, I.N.2.P.3./C.N.R.S., 24 avenue des Landais, 63177 Aubière Cedex, France*
- ¹³² *Laboratoire de Physique Subatomique et de Cosmologie (LPSC), Université Joseph Fourier (Grenoble 1), 53, ave. des Marthyrs, F-38026 Grenoble Cedex, France*
- ¹³³ *Laboratoire de Physique Theorique, Université de Paris-Sud XI, Batiment 210, F-91405 Orsay Cedex, France*
- ¹³⁴ *Laboratori Nazionali di Frascati, via E. Fermi, 40, C.P. 13, I-00044 Frascati, Italy*

- ¹³⁵ *Laboratory of High Energy Physics and Cosmology, Department of Physics, Hanoi National University, 334 Nguyen Trai, Hanoi, Vietnam*
- ¹³⁶ *Lancaster University, Physics Department, Lancaster LA1 4YB, UK*
- ¹³⁷ *Lawrence Berkeley National Laboratory (LBNL), 1 Cyclotron Rd, Berkeley, CA 94720, USA*
- ¹³⁸ *Lawrence Livermore National Laboratory (LLNL), Livermore, CA 94551, USA*
- ¹³⁹ *Lebedev Physical Institute, Leninsky Prospect 53, RU-117924 Moscow, Russia*
- ¹⁴⁰ *Liaoning Normal University, Department of Physics, Dalian, China 116029*
- ¹⁴¹ *Lomonosov Moscow State University, Skobeltsyn Institute of Nuclear Physics (MSU SINP), 1(2), Leninskie gory, GSP-1, Moscow 119991, Russia*
- ¹⁴² *Los Alamos National Laboratory (LANL), P.O.Box 1663, Los Alamos, NM 87545, USA*
- ¹⁴³ *Louisiana Technical University, Department of Physics, Ruston, LA 71272, USA*
- ¹⁴⁴ *Ludwig-Maximilians-Universität München, Department für Physik, Schellingstr. 4, D-80799 Munich, Germany*
- ¹⁴⁵ *Lunds Universitet, Fysiska Institutionen, Avdelningen för Experimentell Högenergifysik, Box 118, 221 00 Lund, Sweden*
- ¹⁴⁶ *Massachusetts Institute of Technology, Laboratory for Nuclear Science & Center for Theoretical Physics, 77 Massachusetts Ave., NW16, Cambridge, MA 02139, USA*
- ¹⁴⁷ *Max-Planck-Institut für Physik (Werner-Heisenberg-Institut), Föhringer Ring 6, 80805 München, Germany*
- ¹⁴⁸ *McGill University, Department of Physics, Ernest Rutherford Physics Bldg., 3600 University Ave., Montreal, Quebec, H3A 2T8 Canada*
- ¹⁴⁹ *Meiji Gakuin University, Department of Physics, 2-37 Shirokanedai 1-chome, Minato-ku, Tokyo 244-8539, Japan*
- ¹⁵⁰ *Michigan State University, Department of Physics and Astronomy, East Lansing, MI 48824, USA*
- ¹⁵¹ *Middle East Technical University, Department of Physics, TR-06531 Ankara, Turkey*
- ¹⁵² *Mindanao Polytechnic State College, Lapasan, Cagayan de Oro City 9000, Phillipines*
- ¹⁵³ *MSU-Iligan Institute of Technology, Department of Physics, Andres Bonifacio Avenue, 9200 Iligan City, Phillipines*
- ¹⁵⁴ *Nagasaki Institute of Applied Science, 536 Abamachi, Nagasaki-Shi, Nagasaki 851-0193, Japan*
- ¹⁵⁵ *Nagoya University, Fundamental Particle Physics Laboratory, Division of Particle and Astrophysical Sciences, Furo-cho, Chikusa-ku, Nagoya, Aichi 464-8602, Japan*
- ¹⁵⁶ *Nanchang University, Department of Physics, Nanchang, China 330031*
- ¹⁵⁷ *Nanjing University, Department of Physics, Nanjing, China 210093*
- ¹⁵⁸ *Nankai University, Department of Physics, Tianjin, China 300071*
- ¹⁵⁹ *National Central University, High Energy Group, Department of Physics, Chung-li, Taiwan 32001*
- ¹⁶⁰ *National Institute for Nuclear & High Energy Physics, PO Box 41882, 1009 DB Amsterdam, Netherlands*
- ¹⁶¹ *National Institute of Radiological Sciences, 4-9-1 Anagawa, Inaga, Chiba 263-8555, Japan*
- ¹⁶² *National Synchrotron Radiation Laboratory, University of Science and Technology of china, Hefei, Anhui, China 230029*
- ¹⁶³ *National Synchrotron Research Center, 101 Hsin-Ann Rd., Hsinchu Science Part, Hsinchu, Taiwan 30076*

- ¹⁶⁴ National Taiwan University, Physics Department, Taipei, Taiwan 106
- ¹⁶⁵ Niels Bohr Institute (NBI), University of Copenhagen, Blegdamsvej 17, DK-2100 Copenhagen, Denmark
- ¹⁶⁶ Niigata University, Department of Physics, Ikarashi, Niigata 950-218, Japan
- ¹⁶⁷ Nikken Sekkai Ltd., 2-18-3 Iidabashi, Chiyoda-Ku, Tokyo 102-8117, Japan
- ¹⁶⁸ Nippon Dental University, 1-9-20 Fujimi, Chiyoda-Ku, Tokyo 102-8159, Japan
- ¹⁶⁹ North Asia University, Akita 010-8515, Japan
- ¹⁷⁰ North Eastern Hill University, Department of Physics, Shillong 793022, India
- ¹⁷¹ Northern Illinois University, Department of Physics, DeKalb, Illinois 60115-2825, USA
- ¹⁷² Northwestern University, Department of Physics and Astronomy, 2145 Sheridan Road., Evanston, IL 60208, USA
- ¹⁷³ Novosibirsk State University (NGU), Department of Physics, Pirogov st. 2, 630090 Novosibirsk, Russia
- ¹⁷⁴ Obninsk State Technical University for Nuclear Engineering (IATE), Obninsk, Russia
- ¹⁷⁵ Ochanomizu University, Department of Physics, Faculty of Science, 1-1 Otsuka 2, Bunkyo-ku, Tokyo 112-8610, Japan
- ¹⁷⁶ Osaka University, Laboratory of Nuclear Studies, 1-1 Machikaneyama, Toyonaka, Osaka 560-0043, Japan
- ¹⁷⁷ Österreichische Akademie der Wissenschaften, Institut für Hochenergiephysik, Nikolsdorfergasse 18, A-1050 Vienna, Austria
- ¹⁷⁸ Panjab University, Chandigarh 160014, India
- ¹⁷⁹ Pavel Sukhoi Gomel State Technical University, ICTP Affiliated Centre & Laboratory for Physical Studies, October Avenue, 48, 246746, Gomel, Belarus
- ¹⁸⁰ Pavel Sukhoi Gomel State Technical University, Physics Department, October Ave. 48, 246746 Gomel, Belarus
- ¹⁸¹ Physical Research Laboratory, Navrangpura, Ahmedabad 380 009, Gujarat, India
- ¹⁸² Pohang Accelerator Laboratory (PAL), San-31 Hyoja-dong, Nam-gu, Pohang, Gyeongbuk 790-784, Korea
- ¹⁸³ Polish Academy of Sciences (PAS), Institute of Physics, Al. Lotnikow 32/46, PL-02-668 Warsaw, Poland
- ¹⁸⁴ Primera Engineers Ltd., 100 S Wacker Drive, Suite 700, Chicago, IL 60606, USA
- ¹⁸⁵ Princeton University, Department of Physics, P.O. Box 708, Princeton, NJ 08542-0708, USA
- ¹⁸⁶ Purdue University, Department of Physics, West Lafayette, IN 47907, USA
- ¹⁸⁷ Pusan National University, Department of Physics, Busan 609-735, Korea
- ¹⁸⁸ R. W. Downing Inc., 6590 W. Box Canyon Dr., Tucson, AZ 85745, USA
- ¹⁸⁹ Raja Ramanna Center for Advanced Technology, Indore 452013, India
- ¹⁹⁰ Rheinisch-Westfälische Technische Hochschule (RWTH), Physikalisches Institut, Physikzentrum, Sommerfeldstrasse 14, D-52056 Aachen, Germany
- ¹⁹¹ RIKEN, 2-1 Hirosawa, Wako, Saitama 351-0198, Japan
- ¹⁹² Royal Holloway, University of London (RHUL), Department of Physics, Egham, Surrey TW20 0EX, UK
- ¹⁹³ Saga University, Department of Physics, 1 Honjo-machi, Saga-shi, Saga 840-8502, Japan
- ¹⁹⁴ Saha Institute of Nuclear Physics, 1/AF Bidhan Nagar, Kolkata 700064, India
- ¹⁹⁵ Salalah College of Technology (SCOT), Engineering Department, Post Box No. 608, Postal Code 211, Salalah, Sultanate of Oman
- ¹⁹⁶ Saube Co., Hanabatake, Tsukuba, Ibaraki 300-3261, Japan

- ¹⁹⁷ Seoul National University, San 56-1, Shinrim-dong, Kwanak-gu, Seoul 151-742, Korea
- ¹⁹⁸ Shandong University, 27 Shanda Nanlu, Jinan, China 250100
- ¹⁹⁹ Shanghai Institute of Applied Physics, Chinese Academy of Sciences, 2019 Jiaruo Rd.,
Jiading, Shanghai, China 201800
- ²⁰⁰ Shinshu University, 3-1-1, Asahi, Matsumoto, Nagano 390-8621, Japan
- ²⁰¹ Sobolev Institute of Mathematics, Siberian Branch of the Russian Academy of Sciences,
4 Acad. Koptyug Avenue, 630090 Novosibirsk, Russia
- ²⁰² Sokenai, The Graduate University for Advanced Studies, Shonan Village, Hayama,
Kanagawa 240-0193, Japan
- ²⁰³ Stanford Linear Accelerator Center (SLAC), 2575 Sand Hill Road, Menlo Park, CA
94025, USA
- ²⁰⁴ State University of New York at Binghamton, Department of Physics, PO Box 6016,
Binghamton, NY 13902, USA
- ²⁰⁵ State University of New York at Buffalo, Department of Physics & Astronomy, 239
Franczak Hall, Buffalo, NY 14260, USA
- ²⁰⁶ State University of New York at Stony Brook, Department of Physics and Astronomy,
Stony Brook, NY 11794-3800, USA
- ²⁰⁷ Sumitomo Heavy Industries, Ltd., Natsushima-cho, Yokosuka, Kanagawa 237-8555,
Japan
- ²⁰⁸ Sungkyunkwan University (SKKU), Natural Science Campus 300, Physics Research
Division, Chunchun-dong, Jangan-gu, Suwon, Kyunggi-do 440-746, Korea
- ²⁰⁹ Swiss Light Source (SLS), Paul Scherrer Institut (PSI), PSI West, CH-5232 Villigen
PSI, Switzerland
- ²¹⁰ Syracuse University, Department of Physics, 201 Physics Building, Syracuse, NY
13244-1130, USA
- ²¹¹ Tata Institute of Fundamental Research, School of Natural Sciences, Homi Bhabha Rd.,
Mumbai 400005, India
- ²¹² Technical Institute of Physics and Chemistry, Chinese Academy of Sciences, 2 North 1st
St., Zhongguancun, Beijing, China 100080
- ²¹³ Technical University of Lodz, Department of Microelectronics and Computer Science, al.
Politechniki 11, 90-924 Lodz, Poland
- ²¹⁴ Technische Universität Dresden, Institut für Kern- und Teilchenphysik, D-01069
Dresden, Germany
- ²¹⁵ Technische Universität Dresden, Institut für Theoretische Physik, D-01062 Dresden,
Germany
- ²¹⁶ Tel-Aviv University, School of Physics and Astronomy, Ramat Aviv, Tel Aviv 69978,
Israel
- ²¹⁷ Texas A&M University, Physics Department, College Station, 77843-4242 TX, USA
- ²¹⁸ Texas Tech University, Department of Physics, Campus Box 41051, Lubbock, TX
79409-1051, USA
- ²¹⁹ The Henryk Niewodniczanski Institute of Nuclear Physics (NINP), High Energy Physics
Lab, ul. Radzikowskiego 152, PL-31342 Cracow, Poland
- ²²⁰ Thomas Jefferson National Accelerator Facility (TJNAF), 12000 Jefferson Avenue,
Newport News, VA 23606, USA
- ²²¹ Tohoku Gakuin University, Faculty of Technology, 1-13-1 Chuo, Tagajo, Miyagi
985-8537, Japan

- ²²² Tohoku University, Department of Physics, Aoba District, Sendai, Miyagi 980-8578, Japan
- ²²³ Tokyo Management College, Computer Science Lab, Ichikawa, Chiba 272-0001, Japan
- ²²⁴ Tokyo University of Agriculture Technology, Department of Applied Physics, Naka-machi, Koganei, Tokyo 183-8488, Japan
- ²²⁵ Toyama University, Department of Physics, 3190 Gofuku, Toyama-shi 930-8588, Japan
- ²²⁶ TRIUMF, 4004 Wesbrook Mall, Vancouver, BC V6T 2A3, Canada
- ²²⁷ Tufts University, Department of Physics and Astronomy, Robinson Hall, Medford, MA 02155, USA
- ²²⁸ Universidad Autònoma de Madrid (UAM), Facultad de Ciencias C-XI, Departamento de Física Teórica, Cantoblanco, Madrid 28049, Spain
- ²²⁹ Universitat Autònoma de Barcelona, Institut de Física d'Altes Energies (IFAE), Campus UAB, Edifici Cn, E-08193 Bellaterra, Barcelona, Spain
- ²³⁰ University College of London (UCL), High Energy Physics Group, Physics and Astronomy Department, Gower Street, London WC1E 6BT, UK
- ²³¹ University College, National University of Ireland (Dublin), Department of Experimental Physics, Science Buildings, Belfield, Dublin 4, Ireland
- ²³² University de Barcelona, Facultat de Física, Av. Diagonal, 647, Barcelona 08028, Spain
- ²³³ University of Abertay Dundee, Department of Physics, Bell St, Dundee, DD1 1HG, UK
- ²³⁴ University of Auckland, Department of Physics, Private Bag, Auckland 1, New Zealand
- ²³⁵ University of Bergen, Institute of Physics, Allegaten 55, N-5007 Bergen, Norway
- ²³⁶ University of Birmingham, School of Physics and Astronomy, Particle Physics Group, Edgbaston, Birmingham B15 2TT, UK
- ²³⁷ University of Bristol, H. H. Wills Physics Lab, Tyndall Ave., Bristol BS8 1TL, UK
- ²³⁸ University of British Columbia, Department of Physics and Astronomy, 6224 Agricultural Rd., Vancouver, BC V6T 1Z1, Canada
- ²³⁹ University of California Berkeley, Department of Physics, 366 Le Conte Hall, #7300, Berkeley, CA 94720, USA
- ²⁴⁰ University of California Davis, Department of Physics, One Shields Avenue, Davis, CA 95616-8677, USA
- ²⁴¹ University of California Irvine, Department of Physics and Astronomy, High Energy Group, 4129 Frederick Reines Hall, Irvine, CA 92697-4575 USA
- ²⁴² University of California Riverside, Department of Physics, Riverside, CA 92521, USA
- ²⁴³ University of California Santa Barbara, Department of Physics, Broida Hall, Mail Code 9530, Santa Barbara, CA 93106-9530, USA
- ²⁴⁴ University of California Santa Cruz, Department of Astronomy and Astrophysics, 1156 High Street, Santa Cruz, CA 05060, USA
- ²⁴⁵ University of California Santa Cruz, Institute for Particle Physics, 1156 High Street, Santa Cruz, CA 95064, USA
- ²⁴⁶ University of Cambridge, Cavendish Laboratory, J J Thomson Avenue, Cambridge CB3 0HE, UK
- ²⁴⁷ University of Colorado at Boulder, Department of Physics, 390 UCB, University of Colorado, Boulder, CO 80309-0390, USA
- ²⁴⁸ University of Delhi, Department of Physics and Astrophysics, Delhi 110007, India
- ²⁴⁹ University of Delhi, S.G.T.B. Khalsa College, Delhi 110007, India
- ²⁵⁰ University of Dundee, Department of Physics, Nethergate, Dundee, DD1 4HN, Scotland, UK

- ²⁵¹ University of Edinburgh, School of Physics, James Clerk Maxwell Building, The King's Buildings, Mayfield Road, Edinburgh EH9 3JZ, UK
- ²⁵² University of Essex, Department of Physics, Wivenhoe Park, Colchester CO4 3SQ, UK
- ²⁵³ University of Florida, Department of Physics, Gainesville, FL 32611, USA
- ²⁵⁴ University of Glasgow, Department of Physics & Astronomy, University Avenue, Glasgow G12 8QQ, Scotland, UK
- ²⁵⁵ University of Hamburg, Physics Department, Institut für Experimentalphysik, Luruper Chaussee 149, 22761 Hamburg, Germany
- ²⁵⁶ University of Hawaii, Department of Physics and Astronomy, HEP, 2505 Correa Rd., WAT 232, Honolulu, HI 96822-2219, USA
- ²⁵⁷ University of Heidelberg, Kirchhoff Institute of Physics, Albert Überle Strasse 3-5, DE-69120 Heidelberg, Germany
- ²⁵⁸ University of Helsinki, Department of Physical Sciences, P.O. Box 64 (Vaino Auerin katu 11), FIN-00014, Helsinki, Finland
- ²⁵⁹ University of Hyogo, School of Science, Kouto 3-2-1, Kamigori, Ako, Hyogo 678-1297, Japan
- ²⁶⁰ University of Illinois at Urbana-Champaign, Department of Phys., High Energy Physics, 441 Loomis Lab. of Physics 1110 W. Green St., Urbana, IL 61801-3080, USA
- ²⁶¹ University of Iowa, Department of Physics and Astronomy, 203 Van Allen Hall, Iowa City, IA 52242-1479, USA
- ²⁶² University of Kansas, Department of Physics and Astronomy, Malott Hall, 1251 Wescoe Hall Drive, Room 1082, Lawrence, KS 66045-7582, USA
- ²⁶³ University of Liverpool, Department of Physics, Oliver Lodge Lab, Oxford St., Liverpool L69 7ZE, UK
- ²⁶⁴ University of Louisville, Department of Physics, Louisville, KY 40292, USA
- ²⁶⁵ University of Manchester, School of Physics and Astronomy, Schuster Lab, Manchester M13 9PL, UK
- ²⁶⁶ University of Maryland, Department of Physics and Astronomy, Physics Building (Bldg. 082), College Park, MD 20742, USA
- ²⁶⁷ University of Melbourne, School of Physics, Victoria 3010, Australia
- ²⁶⁸ University of Michigan, Department of Physics, 500 E. University Ave., Ann Arbor, MI 48109-1120, USA
- ²⁶⁹ University of Minnesota, 148 Tate Laboratory Of Physics, 116 Church St. S.E., Minneapolis, MN 55455, USA
- ²⁷⁰ University of Mississippi, Department of Physics and Astronomy, 108 Lewis Hall, PO Box 1848, Oxford, Mississippi 38677-1848, USA
- ²⁷¹ University of Montenegro, Faculty of Sciences and Math., Department of Phys., P.O. Box 211, 81001 Podgorica, Serbia and Montenegro
- ²⁷² University of New Mexico, New Mexico Center for Particle Physics, Department of Physics and Astronomy, 800 Yale Boulevard N.E., Albuquerque, NM 87131, USA
- ²⁷³ University of Notre Dame, Department of Physics, 225 Nieuwland Science Hall, Notre Dame, IN 46556, USA
- ²⁷⁴ University of Oklahoma, Department of Physics and Astronomy, Norman, OK 73071, USA
- ²⁷⁵ University of Oregon, Department of Physics, 1371 E. 13th Ave., Eugene, OR 97403, USA

- ²⁷⁶ *University of Oxford, Particle Physics Department, Denys Wilkinson Bldg., Keble Road, Oxford OX1 3RH England, UK*
- ²⁷⁷ *University of Patras, Department of Physics, GR-26100 Patras, Greece*
- ²⁷⁸ *University of Pavia, Department of Nuclear and Theoretical Physics, via Bassi 6, I-27100 Pavia, Italy*
- ²⁷⁹ *University of Pennsylvania, Department of Physics and Astronomy, 209 South 33rd Street, Philadelphia, PA 19104-6396, USA*
- ²⁸⁰ *University of Puerto Rico at Mayaguez, Department of Physics, P.O. Box 9016, Mayaguez, 00681-9016 Puerto Rico*
- ²⁸¹ *University of Regina, Department of Physics, Regina, Saskatchewan, S4S 0A2 Canada*
- ²⁸² *University of Rochester, Department of Physics and Astronomy, Bausch & Lomb Hall, P.O. Box 270171, 600 Wilson Boulevard, Rochester, NY 14627-0171 USA*
- ²⁸³ *University of Science and Technology of China, Department of Modern Physics (DMP), Jin Zhai Road 96, Hefei, China 230026*
- ²⁸⁴ *University of Silesia, Institute of Physics, Ul. Uniwersytecka 4, PL-40007 Katowice, Poland*
- ²⁸⁵ *University of Southampton, School of Physics and Astronomy, Highfield, Southampton S017 1BJ, England, UK*
- ²⁸⁶ *University of Strathclyde, Physics Department, John Anderson Building, 107 Rottenrow, Glasgow, G4 0NG, Scotland, UK*
- ²⁸⁷ *University of Sydney, Falkiner High Energy Physics Group, School of Physics, A28, Sydney, NSW 2006, Australia*
- ²⁸⁸ *University of Texas, Center for Accelerator Science and Technology, Arlington, TX 76019, USA*
- ²⁸⁹ *University of Tokushima, Institute of Theoretical Physics, Tokushima-shi 770-8502, Japan*
- ²⁹⁰ *University of Tokyo, Department of Physics, 7-3-1 Hongo, Bunkyo District, Tokyo 113-0033, Japan*
- ²⁹¹ *University of Toronto, Department of Physics, 60 St. George St., Toronto M5S 1A7, Ontario, Canada*
- ²⁹² *University of Tsukuba, Institute of Physics, 1-1-1 Ten'nodai, Tsukuba, Ibaraki 305-8571, Japan*
- ²⁹³ *University of Victoria, Department of Physics and Astronomy, P.O.Box 3055 Stn Csc, Victoria, BC V8W 3P6, Canada*
- ²⁹⁴ *University of Warsaw, Institute of Physics, Ul. Hoza 69, PL-00 681 Warsaw, Poland*
- ²⁹⁵ *University of Warsaw, Institute of Theoretical Physics, Ul. Hoza 69, PL-00 681 Warsaw, Poland*
- ²⁹⁶ *University of Washington, Department of Physics, PO Box 351560, Seattle, WA 98195-1560, USA*
- ²⁹⁷ *University of Wisconsin, Physics Department, Madison, WI 53706-1390, USA*
- ²⁹⁸ *University of Wuppertal, Gaußstraße 20, D-42119 Wuppertal, Germany*
- ²⁹⁹ *Université Claude Bernard Lyon-I, Institut de Physique Nucléaire de Lyon (IPNL), 4, rue Enrico Fermi, F-69622 Villeurbanne Cedex, France*
- ³⁰⁰ *Université de Genève, Section de Physique, 24, quai E. Ansermet, 1211 Genève 4, Switzerland*
- ³⁰¹ *Université Louis Pasteur (Strasbourg I), UFR de Sciences Physiques, 3-5 Rue de l'Université, F-67084 Strasbourg Cedex, France*

- ³⁰² *Université Pierre et Marie Curie (Paris VI-VII) (6-7) (UPMC), Laboratoire de Physique Nucléaire et de Hautes Energies (LPNHE), 4 place Jussieu, Tour 33, Rez de chaussée, 75252 Paris Cedex 05, France*
- ³⁰³ *Universität Bonn, Physikalisches Institut, Nußallee 12, 53115 Bonn, Germany*
- ³⁰⁴ *Universität Karlsruhe, Institut für Physik, Postfach 6980, Kaiserstrasse 12, D-76128 Karlsruhe, Germany*
- ³⁰⁵ *Universität Rostock, Fachbereich Physik, Universitätsplatz 3, D-18051 Rostock, Germany*
- ³⁰⁶ *Universität Siegen, Fachbereich für Physik, Emmy Noether Campus, Walter-Flex-Str.3, D-57068 Siegen, Germany*
- ³⁰⁷ *Università de Bergamo, Dipartimento di Fisica, via Salvecchio, 19, I-24100 Bergamo, Italy*
- ³⁰⁸ *Università degli Studi di Roma La Sapienza, Dipartimento di Fisica, Istituto Nazionale di Fisica Nucleare, Piazzale Aldo Moro 2, I-00185 Rome, Italy*
- ³⁰⁹ *Università degli Studi di Trieste, Dipartimento di Fisica, via A. Valerio 2, I-34127 Trieste, Italy*
- ³¹⁰ *Università degli Studi di “Roma Tre”, Dipartimento di Fisica “Edoardo Amaldi”, Istituto Nazionale di Fisica Nucleare, Via della Vasca Navale 84, 00146 Roma, Italy*
- ³¹¹ *Università dell’Insubria in Como, Dipartimento di Scienze CC.FF.MM., via Valleggio 11, I-22100 Como, Italy*
- ³¹² *Università di Pisa, Dipartimento di Fisica ‘Enrico Fermi’, Largo Bruno Pontecorvo 3, I-56127 Pisa, Italy*
- ³¹³ *Università di Salento, Dipartimento di Fisica, via Arnesano, C.P. 193, I-73100 Lecce, Italy*
- ³¹⁴ *Università di Udine, Dipartimento di Fisica, via delle Scienze, 208, I-33100 Udine, Italy*
- ³¹⁵ *Variable Energy Cyclotron Centre, 1/AF, Bidhan Nagar, Kolkata 700064, India*
- ³¹⁶ *VINCA Institute of Nuclear Sciences, Laboratory of Physics, PO Box 522, YU-11001 Belgrade, Serbia and Montenegro*
- ³¹⁷ *Vinh University, 182 Le Duan, Vinh City, Nghe An Province, Vietnam*
- ³¹⁸ *Virginia Polytechnic Institute and State University, Physics Department, Blacksburg, VA 2406, USA*
- ³¹⁹ *Visva-Bharati University, Department of Physics, Santiniketan 731235, India*
- ³²⁰ *Waseda University, Advanced Research Institute for Science and Engineering, Shinjuku, Tokyo 169-8555, Japan*
- ³²¹ *Wayne State University, Department of Physics, Detroit, MI 48202, USA*
- ³²² *Weizmann Institute of Science, Department of Particle Physics, P.O. Box 26, Rehovot 76100, Israel*
- ³²³ *Yale University, Department of Physics, New Haven, CT 06520, USA*
- ³²⁴ *Yonsei University, Department of Physics, 134 Sinchon-dong, Sudaemoon-gu, Seoul 120-749, Korea*
- ³²⁵ *Zhejiang University, College of Science, Department of Physics, Hangzhou, China 310027*
* deceased

Acknowledgements

We would like to acknowledge the support and guidance of the International Committee on Future Accelerators (ICFA), chaired by A. Wagner of DESY, and the International Linear Collider Steering Committee (ILCSC), chaired by S. Kurokawa of KEK, who established the ILC Global Design Effort, as well as the World Wide Study of the Physics and Detectors.

We are grateful to the ILC Machine Advisory Committee (MAC), chaired by F. Willeke of DESY and the International ILC Cost Review Committee, chaired by L. Evans of CERN, for their advice on the ILC Reference Design. We also thank the consultants who participated in the Conventional Facilities Review at CalTech and in the RDR Cost Review at SLAC.

We would like to thank the directors of the institutions who have hosted ILC meetings: KEK, ANL/FNAL/SLAC/U. Colorado (Snowmass), INFN/Frascati, IIT/Bangalore, TRIUMF/U. British Columbia, U. Valencia, IHEP/Beijing and DESY.

We are grateful for the support of the Funding Agencies for Large Colliders (FALC), chaired by R. Petronzio of INFN, and we thank all of the international, regional and national funding agencies whose generous support has made the ILC Reference Design possible.

Each of the GDE regional teams in the Americas, Asia and Europe are grateful for the support of their local scientific societies, industrial forums, advisory committees and reviewers.

CONTENTS

| | | |
|----------|---|-----------|
| 1 | Physics at a Terascale e^+e^- Linear Collider | 1 |
| 1.1 | Questions about the Universe | 1 |
| 1.2 | The New Landscape of Particle Physics | 3 |
| 1.3 | Precision Requirements for ILC | 5 |
| 1.4 | Specifying Machine Parameters | 5 |
| 2 | The ILC Accelerator | 7 |
| 2.1 | Superconducting RF | 8 |
| 2.2 | The ILC Baseline Design | 11 |
| 2.2.1 | Beam Parameters | 11 |
| 2.2.2 | Electron Source | 14 |
| 2.2.3 | Positron Source | 14 |
| 2.2.4 | Damping Rings | 16 |
| 2.2.5 | Ring to Main Linac (RTML) | 17 |
| 2.2.6 | Main Linacs | 18 |
| 2.2.7 | Beam Delivery System | 20 |
| 2.3 | Sample Sites | 22 |
| 3 | Detectors | 25 |
| 3.1 | Challenges for Detector Design and Technology | 25 |
| 3.2 | Detector Concepts | 27 |
| 3.2.1 | The Silicon Detector (SiD) Concept | 28 |
| 3.2.2 | The Large Detector Concept (LDC) | 29 |
| 3.2.3 | The GLD Concept | 30 |
| 3.2.4 | Fourth Concept (“4 th ”) Detector | 31 |
| 3.3 | Detector and Physics Performance | 32 |
| 3.4 | Interfacing the Detector to the Machine | 34 |
| 4 | Value Estimates | 35 |
| 4.1 | The Accelerator | 35 |
| 4.2 | The Detectors | 36 |
| 5 | Next Steps: R&D and the Engineering Design Phase | 37 |
| 5.1 | Accelerator R&D | 37 |
| 5.2 | The Detector Roadmap: R&D and Engineering Designs | 39 |
| 5.3 | Towards the Engineering Design Report (EDR) | 39 |

CONTENTS

| | |
|------------------------|-----------|
| Bibliography | 41 |
| List of figures | 45 |
| List of tables | 47 |

CHAPTER 1

Physics at a Terascale e^+e^- Linear Collider

1.1 QUESTIONS ABOUT THE UNIVERSE

- *What is the universe? How did it begin?*
- *What are matter and energy? What are space and time?*

These basic questions have been the subject of scientific theories and experiments throughout human history. The answers have revolutionized the enlightened view of the world, transforming society and advancing civilization. Universal laws and principles govern everyday phenomena, some of them manifesting themselves only at scales of time and distance far beyond everyday experience. Particle physics experiments using particle accelerators transform matter and energy, to reveal the basic workings of the universe. Other experiments exploit naturally occurring particles, such as solar neutrinos or cosmic rays, and astrophysical observations, to provide additional insights.

The triumph of 20th century particle physics was the development of the Standard Model. Experiments determined the particle constituents of ordinary matter, and identified four forces binding matter and transforming it from one form to another. This success leads particle physicists to address even more fundamental questions, and explore deeper mysteries in science. The scope of these questions is illustrated by the summary from the report *Quantum Universe*[1]:

1. *Are there undiscovered principles of nature?*
2. *How can we solve the mystery of dark energy?*
3. *Are there extra dimensions of space?*
4. *Do all the forces become one?*
5. *Why are there so many particles?*
6. *What is dark matter? How can we make it in the laboratory?*
7. *What are neutrinos telling us?*
8. *How did the universe begin?*
9. *What happened to the antimatter?*

PHYSICS AT A TERASCALE E^+E^- LINEAR COLLIDER

A worldwide particle physics program explores this fascinating scientific landscape. The International Linear Collider (ILC)[2] is expected to play a central role in an era of revolutionary advances[3] with breakthrough impact on many of these fundamental questions.

The Standard Model includes a third component beyond particles and forces that has not yet been verified, the Higgs mechanism that gives mass to the particles. Many scientific opportunities for the ILC involve the Higgs particle and related new phenomena at Terascale energies. The Standard Model Higgs field permeates the universe, giving mass to elementary particles, and breaking a fundamental electroweak force into two, the electromagnetic and weak forces (Figure 1.1). But quantum effects should destabilize the Higgs of the Standard Model, preventing its operation at Terascale energies. The proposed antidotes for this quantum instability mostly involve dramatic phenomena accessible to the ILC: new forces, a new principle of nature called supersymmetry, or even extra dimensions of space.

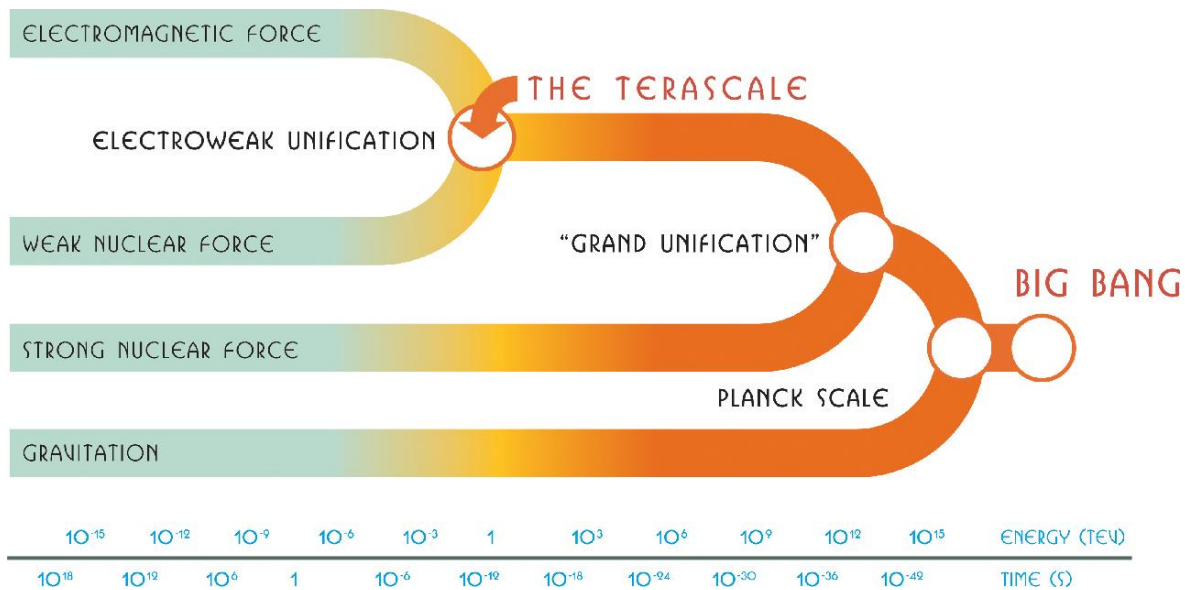

FIGURE 1.1. The electromagnetic and weak nuclear forces unify at the Terascale. The ILC will test unification at even high energy scales (from *Discovering the Quantum Universe*).

Thus the Higgs is central to a broad program of discovery. Is there really a Higgs? Or are there other mechanisms that give mass to particles and break the electroweak force? If there is a Higgs, does it differ from the Standard Model? Is there more than one Higgs particle? What new phenomena stabilize the Higgs at the Terascale?

Astrophysical data show that dark matter dominates the matter content of the universe, and cannot be explained by known particles. Dark matter may be comprised of new weakly interacting particles with Terascale masses. If such Terascale dark matter exists, experiments at the ILC should produce and study such particles, raising important questions (Figure 1.1). Do these new particles have all the properties of the dark matter? Can they alone account for all of the dark matter? How would they affect the evolution of the universe? How do they connect to new principles or forces of nature?

ILC experiments could test the idea that fundamental forces originate from a single “grand” unified force, and search for evidence of a related unified origin of matter involving

supersymmetry. They could distinguish among patterns of phenomena to judge different unification models, providing a telescopic view of the ultimate unification.

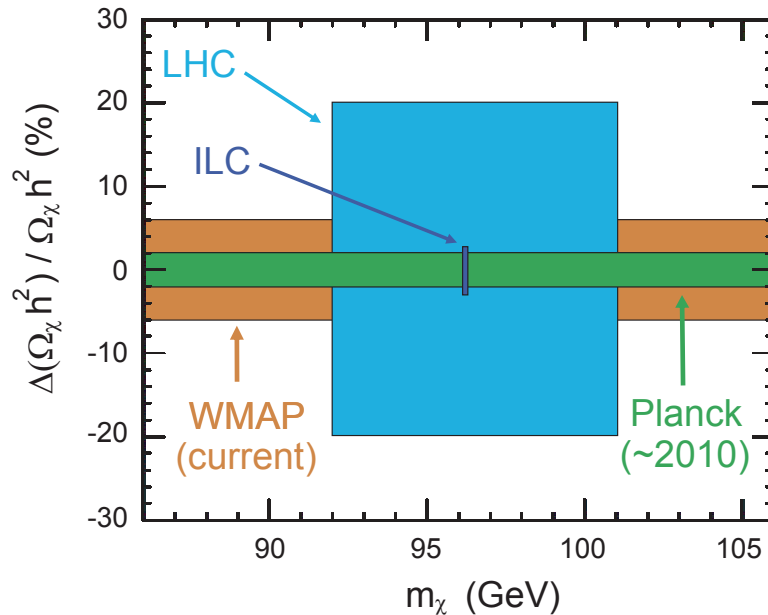

FIGURE 1.2. Accuracy of relic density ($\Omega_\chi h^2$) and mass determinations for neutralino dark matter. Comparison of the LHC and ILC data with that of the WMAP and Planck satellites test neutralinos as the dark matter. (ALCPG Cosmology Subgroup, from chapter 7, volume 2: Physics at the ILC, ILC Reference Design Report)

1.2 THE NEW LANDSCAPE OF PARTICLE PHYSICS

During the next few years, experiments at CERN's Large Hadron Collider will have the first direct look at Terascale physics. While those results are unpredictable [4], they could considerably enhance the physics case for the ILC. Possible discoveries include the Higgs particle, a recurrence of the Z boson (the Z'), evidence for extra dimensions, or observation of supersymmetry (SUSY) particles. Like the discovery of an uncharted continent, exploration of the Terascale could transform forever the geography of our universe. Equally compelling will be the interplay of LHC discoveries with other experiments and observations. Particle physics should be entering a new era of intellectual ferment and revolutionary advance.

If there is a Higgs boson, it is almost certain to be found at the LHC and its mass measured by the ATLAS and CMS experiments. If there is a multiplet of Higgs bosons, there is a good chance the LHC experiments will see more than one. However it will be difficult for the LHC to measure the spin and parity of the Higgs particle and thus to establish its essential nature; the ILC can make these measurements accurately. If there is more than one decay channel of the Higgs, the LHC experiments will determine the ratio of branching fractions (roughly 7-30%); the ILC will measure these couplings to quarks and vector bosons at the few percent level, and thus reveal whether the Higgs is the simple Standard Model object, or something more complex.

This first look at Terascale physics by the LHC can have three possible outcomes. The first possibility is that a Higgs boson consistent with Standard Model properties has been found. Then the ILC will be able to make a more complete and precise experimental analysis to verify if it is indeed Standard Model or something else. The second possibility is that a Higgs boson is found with gross features at variance with the Standard Model. Such discrepancies might be a Higgs mass significantly above Standard Model expectations, a large deviation in the predicted pattern of Higgs decay, or the discovery of multiple Higgs particles. The ILC measurements of couplings and quantum numbers will point to the new physics at work. The third possibility is that no Higgs boson is seen. In this case, the ILC precision measurements of top quark, Z and W boson properties will point the way to an alternate theory. In all cases, the ILC will be essential to a full understanding of the Higgs and its relation to other new fundamental phenomena.

The ATLAS and CMS experiments at LHC will have impressive capabilities to discover new heavy particles. They could detect a new Z' gauge boson as heavy as 5 TeV[5], or squarks and gluinos of supersymmetry up to 2.5 TeV[4]. New particles with mass up to a few TeV associated with the existence of extra spatial dimensions could be seen[4]. The discovery of a Z' particle would indicate a new fundamental force of nature. The question would be to deduce the properties of this force, its origins, its relation to the other forces in a unified framework, and its role in the earliest moments of the universe. The ILC would play a definitive role in addressing these questions.

If supersymmetry is responsible for stabilizing the electroweak unification at the Terascale and for providing a light Higgs boson, signals of superpartner particles should be seen at the LHC. But are the new heavy particles actually superpartners, with the right spins and couplings? Is supersymmetry related to unification at a higher energy scale? What was its role in our cosmic origins? Definitive answers to these questions will require precise measurements of the superpartner particles and the Higgs particles. This will require the best possible results from the LHC and the ILC in a combined analysis.

Supersymmetry illustrates the possible interplay between different experiments and observations. Missing energy signatures at the LHC may indicate a weakly interacting massive particle consistent with a supersymmetric particle. Direct or indirect dark matter searches may see a signal for weakly interacting exotic particles in our galactic halo. Are these particles neutralinos, responsible for some or all of the dark matter? Does the supersymmetry model preferred by collider data predict the observed abundance of dark matter (Figure 1.1), or do assumptions about the early history of the universe need to change? ILC measurements will be mandatory for these analyses.

Alternative possible structures of the new physics include phenomena containing extra dimensions, introducing connections between Terascale physics and gravity. One possibility is that the weakness of gravity could be understood by the escape of the gravitons into the new large extra dimensions. Events with unbalanced momentum caused by the escaping gravitons could be seen at both the LHC and the ILC. The ILC could confirm this scenario by observing anomalous electron positron pair production caused by graviton exchange.

Another possible extra-dimensional model (warped extra-dimensions) postulates two three-dimensional branes separated along one of the new dimensions. In this scenario, new resonances could appear at the colliders, and again pair production at the ILC would be critical to confirmation. The measurement of the couplings to leptons at the ILC would reveal the nature of the new states.

In these differing scenarios, the ILC has a critical role to play in resolving the confusing

possible interpretations. In some scenarios the new phenomena are effectively hidden from the LHC detectors, but are revealed as small deviations in couplings that could be measured at the ILC. In some cases the LHC experiments could definitively identify the existence of extra dimensions. Then the ILC would explore the size, shape, origins and impact of this expanded universe. A powerful feature of the ILC is its capability to explore new physics in a model independent way.

1.3 PRECISION REQUIREMENTS FOR ILC

ILC has an unprecedented potential for precision measurements, with new windows of exploration for physics beyond the Standard Model. This implies new requirements on theoretical and experimental accuracies. This in turn drives the need for more precise theoretical calculations for standard, Higgs and supersymmetry processes at the Terascale. There must be a corresponding effort to eliminate all known instrumental limitations which could compromise the precision of the measurements. These would include limits on the accuracy of momentum resolution, jet reconstruction, or reconstruction of short lived particles.

The ILC will search for invisible particles, candidates for the Dark Matter. This requires that the detector be as hermetic as possible. Machine backgrounds must be well controlled to reach the highest precision. The luminosity and polarisation of the beams must also be accurately known.

1.4 SPECIFYING MACHINE PARAMETERS

The accelerator described in Chapter 2 has been designed to meet the basic parameters required for the planned physics program [6]. The initial maximum center of mass energy is $\sqrt{s} = 500$ GeV. Physics runs are possible for every energy above $\sqrt{s} = 200$ GeV and calibration runs with limited luminosity are possible at $\sqrt{s} = 91$ GeV. The beam energy can be changed in small steps for mass measurement threshold scans.

The total luminosity required is 500 fb^{-1} within the first four years of operation and 1000 fb^{-1} during the first phase of operation at 500 GeV. The electron beam must have a polarisation larger than 80%. The positron source should be upgradable to produce a beam with more than $\pm 50\%$ polarisation[7]. Beam energy and polarisation must be stable and measurable at a level of about 0.1%.

An e^+e^- collider is uniquely capable of operation at a series of energies near the threshold of a new physical process. This is an extremely powerful tool for precision measurements of particle masses and unambiguous particle spin determinations. In a broad range of scenarios, including those with many new particles to explore and thresholds to measure, it is possible to achieve precision for all relevant observables in a reasonable time span.

All of the physics scenarios studied indicate that a $\sqrt{s} = 500$ GeV collider can have a great impact on understanding the physics of the Terascale. An energy upgrade up to $\sqrt{s} \sim 1$ TeV opens the door to even greater discoveries. With modest modifications, the ILC can also offer other options if required by physics, although these are not all explicitly included in the RDR design. For GigaZ, the ILC would run on the Z-resonance with high luminosity and both beams polarised, producing 10^9 hadronic Z decays in less than a year. The ILC could also run at the W-pair production threshold for a high precision W-mass measurement[8]. Both linacs could accelerate electrons for an e^-e^- collider[9], measuring the mass of a particular

PHYSICS AT A TERASCALE E^+E^- LINEAR COLLIDER

supersymmetric particle, the selectron, if it exists in the ILC energy range. Colliding electrons with a very intense laser beam near the interaction point can produce a high energy, high quality photon beam, resulting in an $e^- \gamma$ or $\gamma \gamma$ collider[10]. After operating below or at 500 GeV for a number of years, the ILC could be upgraded to higher energy or be modified for one of the options. It would then operate for several years in the new configuration.

CHAPTER 2

The ILC Accelerator

The ILC is based on 1.3 GHz superconducting radio-frequency (SCRF) accelerating cavities. The use of the SCRF technology was recommended by the International Technology Recommendation Panel (ITRP) in August 2004 [11], and shortly thereafter endorsed by the International Committee for Future Accelerators (ICFA). In an unprecedented milestone in high-energy physics, the many institutes around the world involved in linear collider R&D united in a common effort to produce a global design for the ILC. In November 2004, the 1st International Linear Collider Workshop was held at KEK, Tsukuba, Japan. The workshop was attended by some 200 physicists and engineers from around the world, and paved the way for the 2nd ILC Workshop in August 2005, held at Snowmass, Colorado, USA, where the ILC Global Design Effort (GDE) was officially formed. The GDE membership reflects the global nature of the collaboration, with accelerator experts from all three regions (Americas, Asia and Europe). The first major goal of the GDE was to define the basic parameters and layout of the machine – the Baseline Configuration. This was achieved at the first GDE meeting held at INFN, Frascati, Italy in December 2005 with the creation of the Baseline Configuration Document (BCD). During the next 14 months, the BCD was used as the basis for the detailed design work and value estimate culminating in the completion of the second major milestone, the publication of the draft ILC Reference Design Report (RDR).

The technical design and cost estimate for the ILC is based on two decades of world-wide Linear Collider R&D, beginning with the construction and operation of the SLAC Linear Collider (SLC). The SLC is acknowledged as a proof-of-principle machine for the linear collider concept. The ILC SCRF linac technology was pioneered by the TESLA collaboration¹, culminating in a proposal for a 500 GeV center-of-mass linear collider in 2001 [12]. The concurrent (competing) design work on a normal conducting collider (NLC with X-band [13] and GLC with X- or C-Band [14]), has advanced the design concepts for the ILC injectors, Damping Rings (DR) and Beam Delivery System (BDS), as well as addressing overall operations, machine protection and availability issues. The X- and C-band R&D has led to concepts for RF power sources that may eventually produce either cost and/or performance benefits. Finally, the European XFEL [15] to be constructed at DESY, Hamburg, Germany, will make use of the TESLA linac technology, and represents a significant on-going R&D effort of great benefit for the ILC.

The current ILC baseline assumes an average accelerating gradient of 31.5 MV/m in the cavities to achieve a center-of-mass energy of 500 GeV. The high luminosity requires the

¹Now known as the TESLA Technology Collaboration (TTC); see <http://tesla.desy.de>

use of high power and small emittance beams. The choice of 1.3 GHz SCRF is well suited to the requirements, primarily because the very low power loss in the SCRF cavity walls allows the use of long RF pulses, relaxing the requirements on the peak-power generation, and ultimately leading to high wall-plug to beam transfer efficiency.

The primary cost drivers are the SCRF Main Linac technology and the Conventional Facilities (including civil engineering). The choice of gradient is a key cost and performance parameter, since it dictates the length of the linacs, while the cavity quality factor (Q_0) relates to the required cryogenic cooling power. The achievement of 31.5 MV/m as the baseline average operational accelerating gradient – requiring a minimum performance of 35 MV/m during cavity mass-production acceptance testing – represents the primary challenge to the global ILC R&D

With the completion of the RDR, the GDE will begin an engineering design study, closely coupled with a prioritized R&D program. The goal is to produce an Engineering Design Report (EDR) by 2010, presenting the matured technology, design and construction plan for the ILC, allowing the world High Energy Physics community to seek government-level project approvals, followed by start of construction in 2012. When combined with the seven-year construction phase that is assumed in studies presented in RDR, this timeline will allow operations to begin in 2019. This is consistent with a technically driven schedule for this international project.

2.1 SUPERCONDUCTING RF

The primary cost driver for the ILC is the superconducting RF technology used for the Main Linacs, bunch compressors and injector linacs. In 1992, the TESLA Collaboration began R&D on 1.3 GHz technology with a goal of reducing the cost per MeV by a factor of 20 over the then state-of-the-art SCRF installation (CEBAF). This was achieved by increasing the operating accelerating gradient by a factor of five from 5 MV/m to 25 MV/m, and reducing the cost per meter of the complete accelerating module by a factor of four for large-scale production.



FIGURE 2.1. A TESLA nine-cell 1.3 GHz superconducting niobium cavity.

The TESLA cavity R&D was based on extensive existing experience from CEBAF (Jefferson Lab), CERN, Cornell University, KEK, Saclay and Wuppertal. The basic element of the technology is a nine-cell 1.3 GHz niobium cavity, shown in Figure 2.1. Approximately

160 of these cavities have been fabricated by industry as part of the on-going R&D program at DESY; some 17,000 are needed for the ILC.

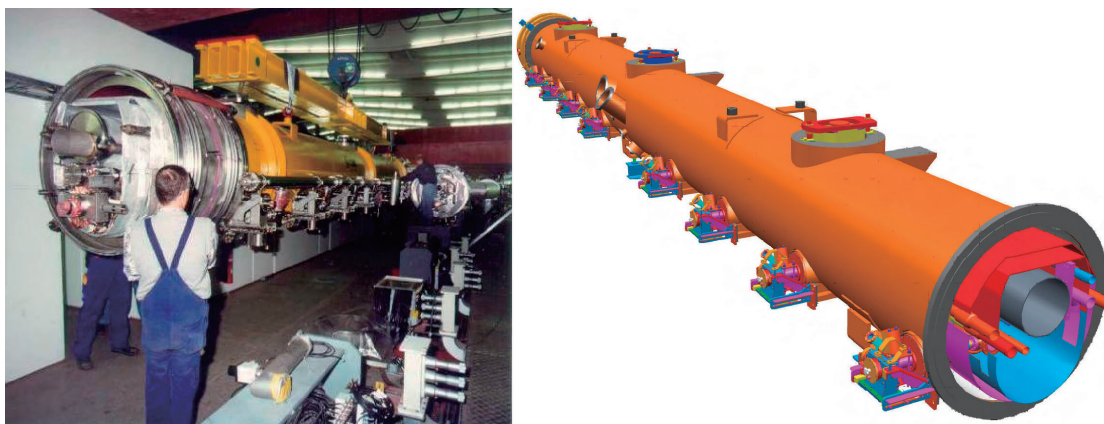

FIGURE 2.2. SCRF Cryomodules. Left: an 8 cavity TESLA cryomodule is installed into the FLASH linac at DESY. Right: design for the 4th generation ILC prototype cryomodule, due to be constructed at Fermilab National Laboratory.

A single cavity is approximately 1 m long. The cavities must be operated at 2 K to achieve their performance. Eight or nine cavities are mounted together in a string and assembled into a common low-temperature cryostat or *cryomodule* (Figure 2.2), the design of which is already in the third generation. Ten cryomodules have been produced to-date, five of which are currently installed in the VUV free-electron laser (FLASH)² at DESY, where they are routinely operated. DESY is currently preparing for the construction of the European XFEL facility, which will have a ~ 20 GeV superconducting linac containing 116 cryomodules.

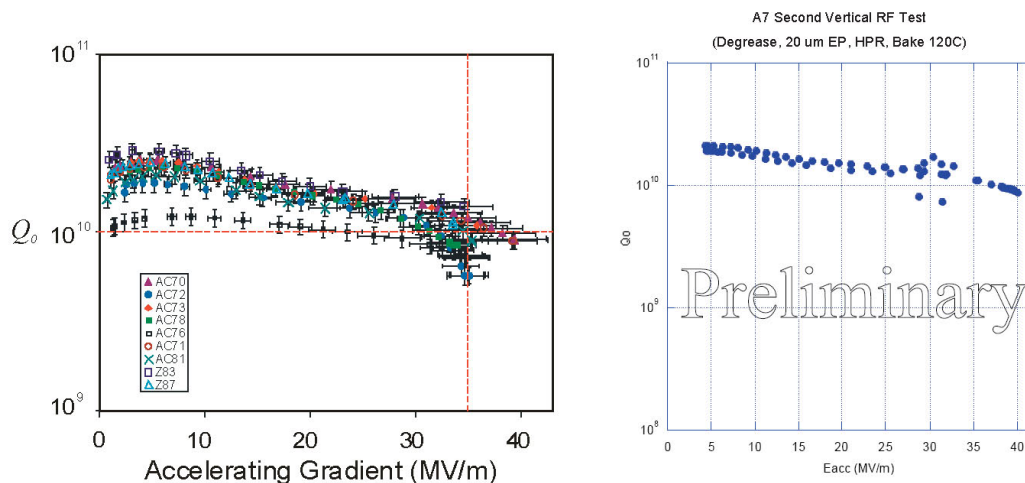

FIGURE 2.3. High-performance nine-cell cavities. Left: Examples of DESY nine-cell cavities achieving ≥ 35 MV/m. Right: Recent result from Jefferson Lab of nine-cell cavity achieving 40 MV/m.

The ILC community has set an aggressive goal of routinely achieving³ 35 MV/m in nine-cell cavities, with a minimum production yield of 80%. Several cavities have already achieved

²Originally known as the TESLA Test Facility (TTF).

³Acceptance test.

THE ILC ACCELERATOR

these and higher gradients (see Figure 2.3), demonstrating proof of principle. Records of over 50 MV/m have been achieved in single-cell cavities at KEK and Cornell[16]. However, it is still a challenge to achieve the desired production yield for nine-cell cavities at the mass-production levels ($\sim 17,000$ cavities) required.

The key to high-gradient performance is the ultra-clean and defect-free inner surface of the cavity. Both cavity preparation and assembly into cavity strings for the cryomodules must be performed in clean-room environments (Figure 2.4).



FIGURE 2.4. Clean room environments are mandatory. Left: the assembly of eight nine-cell TESLA cavities into a cryomodule string at DESY. Right: an ICHIRO nine-cell cavity is prepared for initial tests at the Superconducting RF Test Facility (STF) at KEK.

The best cavities have been achieved using electropolishing, a common industry practice which was first developed for use with superconducting cavities by CERN and KEK. Over the last few years, research at Cornell, DESY, KEK and Jefferson Lab has led to an agreed standard procedure for cavity preparation, depicted in Figure 2.5. The focus of the R&D is now to optimize the process to guarantee the required yield. The ILC SCRF community has developed an internationally agreed-upon plan to address the priority issues.

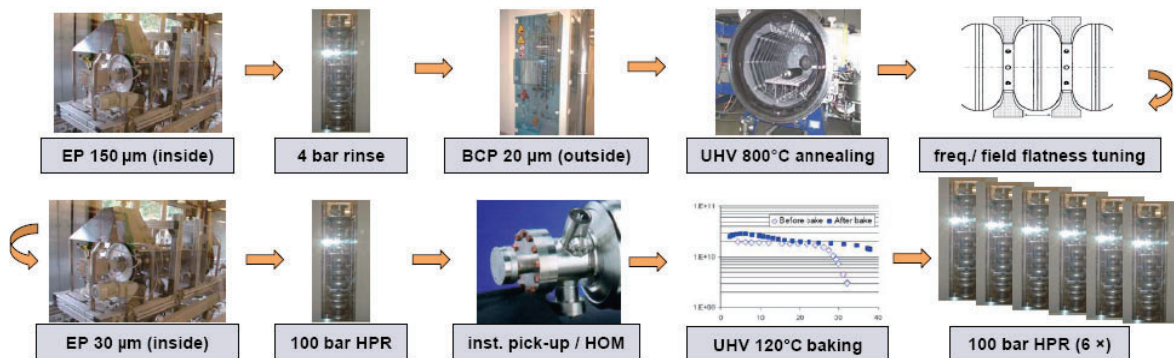

FIGURE 2.5. Birth of a nine-cell cavity: basic steps in surface treatment needed to achieve high-performance superconducting cavities. (EP = electropolishing; HPR = high-pressure rinsing.)

The high-gradient SCRF R&D required for ILC is expected to ramp-up world-wide over

the next years. The U.S. is currently investing in new infrastructure for nine-cell cavity preparation and string and cryomodule assembly. These efforts are centered at Fermilab (ILC Test Accelerator, or ILCTA), together with ANL, Cornell University, SLAC and Jefferson Lab. In Japan, KEK is developing the Superconducting RF Test Facility (STF). In Europe, the focus of R&D at DESY has shifted to industrial preparation for construction of the XFEL. There is continued R&D to support the high-gradient program, as well as other critical ILC-related R&D such as high-power RF couplers (LAL, Orsay, France) and cavity tuners (CEA Saclay, France; INFN Milan, Italy).

The quest for high-gradient and affordable SCRF technology for high-energy physics has revolutionized accelerator applications. In addition to the recently completed Spallation Neutron Source (SNS) in Oak Ridge, Tennessee and the European XFEL under construction, many linac-based projects utilizing SCRF technology are being developed, including 4th-generation light sources such as single-pass FELs and energy-recovery linacs. For the large majority of new accelerator-based projects, SCRF has become the technology of choice.

2.2 THE ILC BASELINE DESIGN

The overall system design has been chosen to realize the physics requirements with a maximum CM energy of 500 GeV and a peak luminosity of $2 \times 10^{34} \text{ cm}^{-2}\text{s}^{-1}$. Figure 2.6 shows a schematic view of the overall layout of the ILC, indicating the location of the major sub-systems:

- a polarized electron source based on a photocathode DC gun;
- an undulator-based positron source, driven by the 150 GeV main electron beam;
- 5 GeV electron and positron damping rings (DR) with a circumference of 6.7 km, housed in a common tunnel at the center of the ILC complex;
- beam transport from the damping rings to the main linacs, followed by a two-stage bunch compressor system prior to injection into the main linac;
- two 11 km long main linacs, utilizing 1.3 GHz SCRF cavities, operating at an average gradient of 31.5 MV/m, with a pulse length of 1.6 ms;
- a 4.5 km long beam delivery system, which brings the two beams into collision with a 14 mrad crossing angle, at a single interaction point which can be shared by two detectors.

The total footprint is ~ 31 km. The electron source, the damping rings, and the positron auxiliary (‘keep-alive’) source are centrally located around the interaction region (IR). The plane of the damping rings is elevated by ~ 10 m above that of the BDS to avoid interference.

To upgrade the machine to $E_{\text{cms}} = 1$ TeV, the linacs and the beam transport lines from the damping rings would be extended by another ~ 11 km each. Certain components in the beam delivery system would also need to be augmented or replaced.

2.2.1 Beam Parameters

The nominal beam parameter set, corresponding to the design luminosity of $2 \times 10^{34} \text{ cm}^{-2}\text{s}^{-1}$ at $E_{\text{cms}} = 500$ GeV is given in Table 2.1. These parameters have been chosen to optimize between known accelerator physics and technology challenges throughout the whole accelerator complex. Examples of such challenges are:

THE ILC ACCELERATOR

- beam instability and kicker hardware constraints in the damping rings;
- beam current, beam power, and pulse length limitations in the main linacs;
- emittance preservation requirements, in the main linacs and the BDS;
- background control and kink instability issues in the interaction region.

Nearly all high-energy physics accelerators have shown unanticipated difficulties in reaching their design luminosity. The ILC design specifies that each subsystem support a range of beam parameters. The resulting flexibility in operating parameters will allow identified

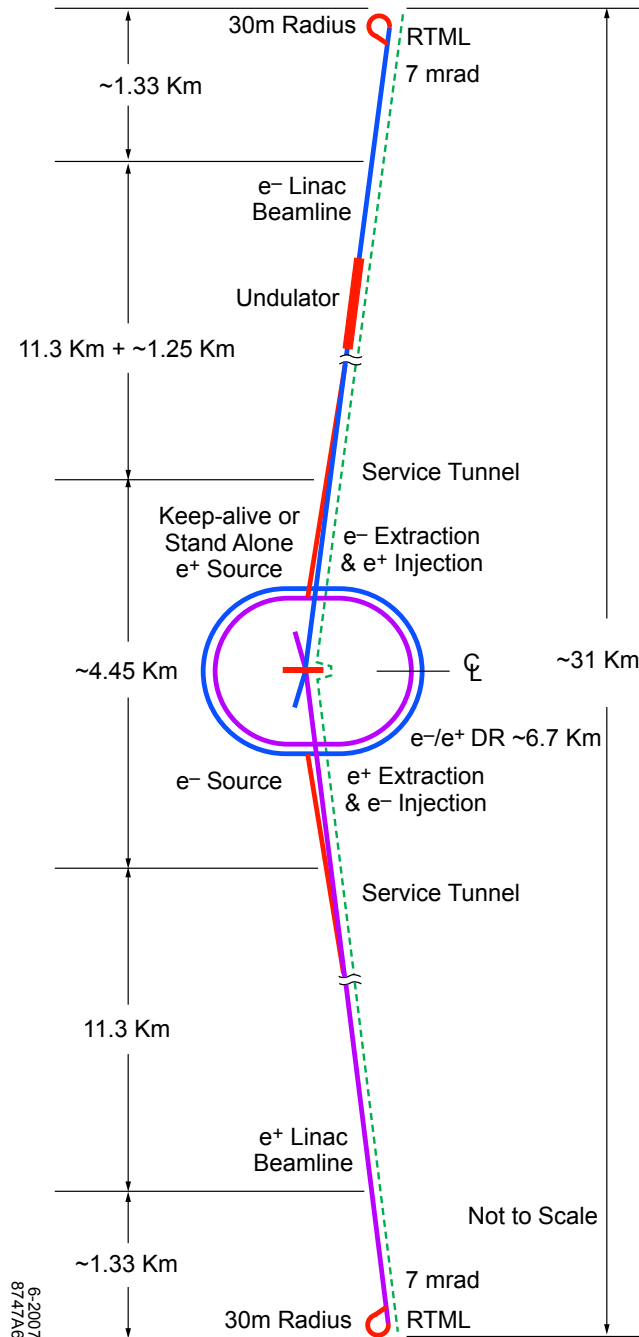

FIGURE 2.6. Schematic layout of the ILC complex for 500 GeV CM.

TABLE 2.1

Basic design parameters for the ILC (^a values at 500 GeV center-of-mass energy).

| Parameter | Unit | |
|--|-------------------------------|--------------------|
| Center-of-mass energy range | GeV | 200 - 500 |
| Peak luminosity ^{a)} | $\text{cm}^{-2}\text{s}^{-1}$ | 2×10^{34} |
| Average beam current in pulse | mA | 9.0 |
| Pulse rate | Hz | 5.0 |
| Pulse length (beam) | ms | ~ 1 |
| Number of bunches per pulse | | 1000 - 5400 |
| Charge per bunch | nC | 1.6 - 3.2 |
| Accelerating gradient ^{a)} | MV/m | 31.5 |
| RF pulse length | ms | 1.6 |
| Beam power (per beam) ^{a)} | MW | 10.8 |
| Typical beam size at IP ^{a)} ($h \times v$) | nm | 640×5.7 |
| Total AC Power consumption ^{a)} | MW | 230 |

problems in one area to be compensated for in another. The nominal IP beam parameters and design ranges are presented in Table 2.2.

TABLE 2.2

Nominal and design range of beam parameters at the IP. The min. and max. columns do not represent consistent sets of parameters, but only indicate the span of the design range for each parameter. (Nominal vertical emittance assumes a 100% emittance dilution budget from the damping ring to the IP.)

| | min | nominal. | max. | unit |
|---|------|----------|------|------------------|
| Bunch population | 1 | 2 | 2 | $\times 10^{10}$ |
| Number of bunches | 1260 | 2625 | 5340 | |
| Linac bunch interval | 180 | 369 | 500 | ns |
| RMS bunch length | 200 | 300 | 500 | μm |
| Normalized horizontal emittance at IP | 10 | 10 | 12 | mm-mrad |
| Normalized vertical emittance at IP | 0.02 | 0.04 | 0.08 | mm-mrad |
| Horizontal beta function at IP | 10 | 20 | 20 | mm |
| Vertical beta function at IP | 0.2 | 0.4 | 0.6 | mm |
| RMS horizontal beam size at IP | 474 | 640 | 640 | nm |
| RMS vertical beam size at IP | 3.5 | 5.7 | 9.9 | nm |
| Vertical disruption parameter | 14 | 19.4 | 26.1 | |
| Fractional RMS energy loss to beamstrahlung | 1.7 | 2.4 | 5.5 | % |

2.2.2 Electron Source

Functional Requirements

The ILC polarized electron source must:

- generate the required bunch train of polarized electrons ($> 80\%$ polarization);
- capture and accelerate the beam to 5 GeV;
- transport the beam to the electron damping ring with minimal beam loss, and perform an energy compression and spin rotation prior to injection.

System Description

The polarized electron source is located on the positron linac side of the damping rings. The beam is produced by a laser illuminating a photocathode in a DC gun. Two independent laser and gun systems provide redundancy. Normal-conducting structures are used for bunching and pre-acceleration to 76 MeV, after which the beam is accelerated to 5 GeV in a superconducting linac. Before injection into the damping ring, superconducting solenoids rotate the spin vector into the vertical, and a separate superconducting RF structure is used for energy compression. The layout of the polarized electron source is shown in Figure 2.7.

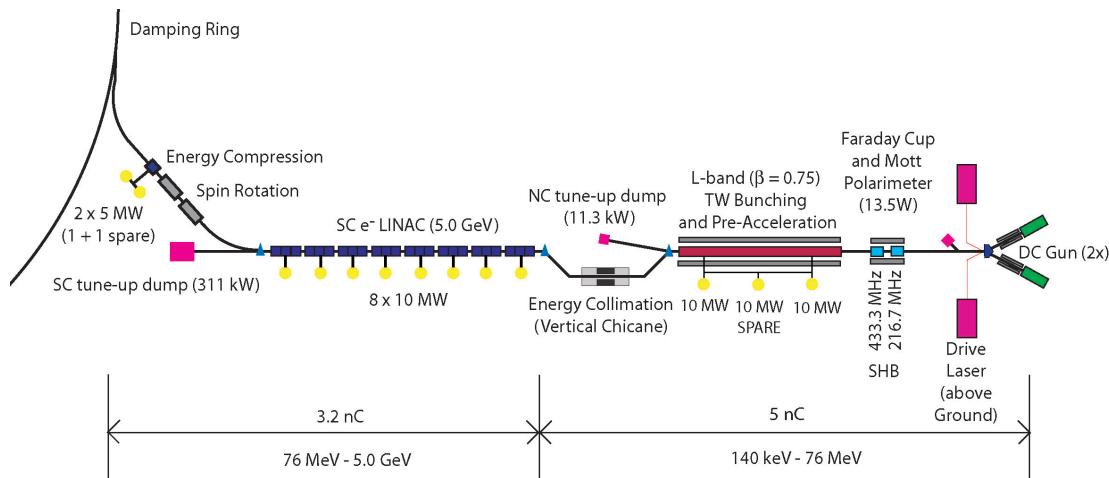

FIGURE 2.7. Schematic View of the Polarized Electron Source.

Challenges

The SLC polarized electron source already meets the requirements for polarization, charge and lifetime. The primary challenge for the ILC electron source is the 1 ms long bunch train, which demands a laser system beyond that used at any existing accelerator.

2.2.3 Positron Source

Functional requirements

The positron source must perform several critical functions:

- generate a high-power multi-MeV photon production drive beam in a suitably short-period, high K-value helical undulator;

- produce the needed positron bunches in a metal target that can reliably deal with the beam power and induced radioactivity;
- capture and accelerate the beam to 5 GeV ;
- transport the beam to the positron damping ring with minimal beam loss, and perform an energy compression and spin rotation prior to injection.

System Description

The major elements of the ILC positron source are shown in Figure 2.8. The source uses photoproduction to generate positrons. After acceleration to 150 GeV, the electron beam is diverted into an offset beamline, transported through a 150-meter helical undulator, and returned to the electron linac. The high-energy (~ 10 MeV) photons from the undulator are directed onto a rotating 0.4 radiation-length Ti-alloy target ~ 500 meters downstream, producing a beam of electron and positron pairs. This beam is then matched using an optical-matching device into a normal conducting (NC) L-band RF and solenoidal-focusing capture system and accelerated to 125 MeV. The electrons and remaining photons are separated from the positrons and dumped. The positrons are accelerated to 400 MeV in a NC L-band linac with solenoidal focusing. The beam is transported 5 km through the rest of the electron main linac tunnel, brought to the central injector complex, and accelerated to 5 GeV using superconducting L-band RF. Before injection into the damping ring, superconducting solenoids rotate the spin vector into the vertical, and a separate superconducting RF structure is used for energy compression.

The baseline design is for unpolarized positrons, although the beam has a polarization of 30%, and beamline space has been reserved for an eventual upgrade to 60% polarization.

To allow commissioning and tuning of the positron systems while the high-energy electron beam is not available, a low-intensity auxiliary (or “keep-alive”) positron source is provided. This is a conventional positron source, which uses a 500 MeV electron beam impinging on a heavy-metal target to produce $\sim 10\%$ of the nominal positron beam. The keep-alive and primary sources use the same linac to accelerate from 400 MeV to 5 GeV.

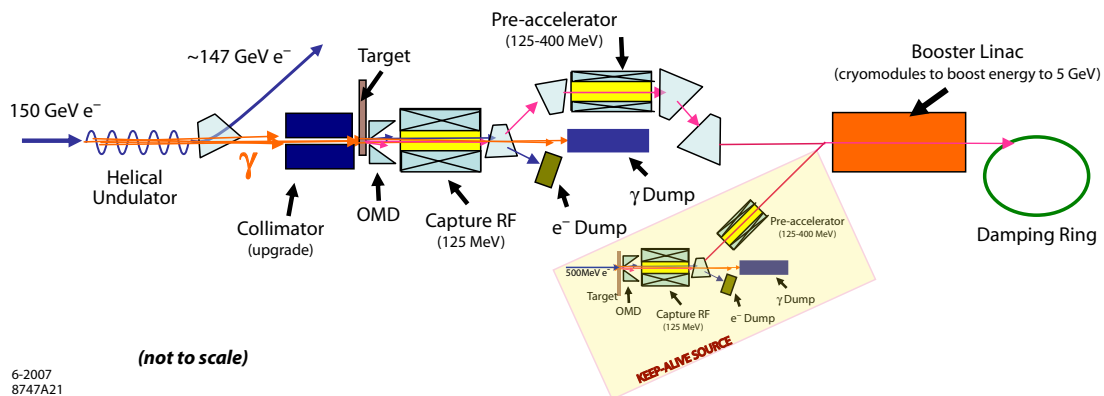

FIGURE 2.8. Overall Layout of the Positron Source.

Challenges

The most challenging elements of the positron source are:

- the 150 m long superconducting helical undulator, which has a period of 1.15 cm and a K-value of 0.92, and a 6 mm inner diameter vacuum chamber;

- the Ti-alloy target, which is a cylindrical wheel 1.4 cm thick and 1 m in diameter, which must rotate at 100 m/s in vacuum to limit damage by the photon beam;
- the normal-conducting RF system which captures the positron beam, which must sustain high accelerator gradients during millisecond-long pulses in a strong magnetic field, while providing adequate cooling in spite of high RF and particle-loss heating.

The target and capture sections are also high-radiation areas which present remote handling challenges.

2.2.4 Damping Rings

Functional requirements

The damping rings must perform four critical functions:

- accept e^- and e^+ beams with large transverse and longitudinal emittances and damp to the low emittance beam required for luminosity production (by five orders of magnitude for the positron vertical emittance), within the 200 ms between machine pulses;
- inject and extract individual bunches without affecting the emittance or stability of the remaining stored bunches;
- damp incoming beam jitter (transverse and longitudinal) and provide highly stable beams for downstream systems;
- delay bunches from the source to allow feed-forward systems to compensate for pulse-to-pulse variations in parameters such as the bunch charge.

System Description

The ILC damping rings include one electron and one positron ring, each 6.7 km long, operating at a beam energy of 5 GeV. The two rings are housed in a single tunnel near the center of the site, with one ring positioned directly above the other. The plane of the DR tunnel is located ~ 10 m higher than that of the beam delivery system. This elevation difference gives adequate shielding to allow operation of the injector system while other systems are open to human access.

The damping ring lattice is divided into six arcs and six straight sections. The arcs are composed of TME cells; the straight sections use a FODO lattice. Four of the straight sections contain the RF systems and the superconducting wigglers. The remaining two sections are used for beam injection and extraction. Except for the wigglers, all of the magnets in the ring, are normal-conducting. Approximately 200 m of superferric wigglers are used in each damping ring. The wigglers are 2.5 m long devices, operating at 4.5K, with a peak field of 1.67 T.

The superconducting RF system is operated CW at 650 MHz, and provides 24 MV for each ring. The frequency is chosen to be half the linac RF frequency to easily accommodate different bunch patterns. The single-cell cavities operate at 4.5 K and are housed in eighteen 3.5 m long cryomodules. Although a number of 500 MHz CW RF systems are currently in operation, development work is required for this 650 MHz system, both for cavities and power sources.

The momentum compaction of the lattice is relatively large, which helps to maintain single bunch stability, but requires a relatively high RF voltage to achieve the design RMS bunch length (9 mm). The dynamic aperture of the lattice is sufficient to allow the large emittance injected beam to be captured with minimal loss.

Challenges

The principal challenges in the damping ring are:

- control of the electron cloud effect in the positron damping ring. This effect, which can cause instability, tune spread, and emittance growth, has been seen in a number of other rings and is relatively well understood. Simulations indicate that it can be controlled by proper surface treatment of the vacuum chamber to suppress secondary emission, and by the use of solenoids and clearing electrodes to suppress the buildup of the cloud.
- control of the fast ion instability in the electron damping ring. This effect can be controlled by limiting the pressure in the electron damping ring to below 1 nTorr, and by the use of short gaps in the ring fill pattern.
- development of a very fast rise and fall time kicker for single bunch injection and extraction in the ring. For the most demanding region of the beam parameter range, the bunch spacing in the damping ring is ~ 3 ns, and the kicker must have a rise plus fall time no more than twice this. Short stripline kicker structures can achieve this, but the drive pulser technology still needs development.

2.2.5 Ring to Main Linac (RTML)

Functional requirements

The RTML must perform several critical functions for each beam:

- transport the beam from the damping ring to the upstream end of the linac;
- collimate the beam halo generated in the damping ring;
- rotate the polarization from the vertical to any arbitrary angle required at the IP;
- compress the long Damping Ring bunch length by a factor of $30 \sim 45$ to provide the short bunches required by the Main Linac and the IP;

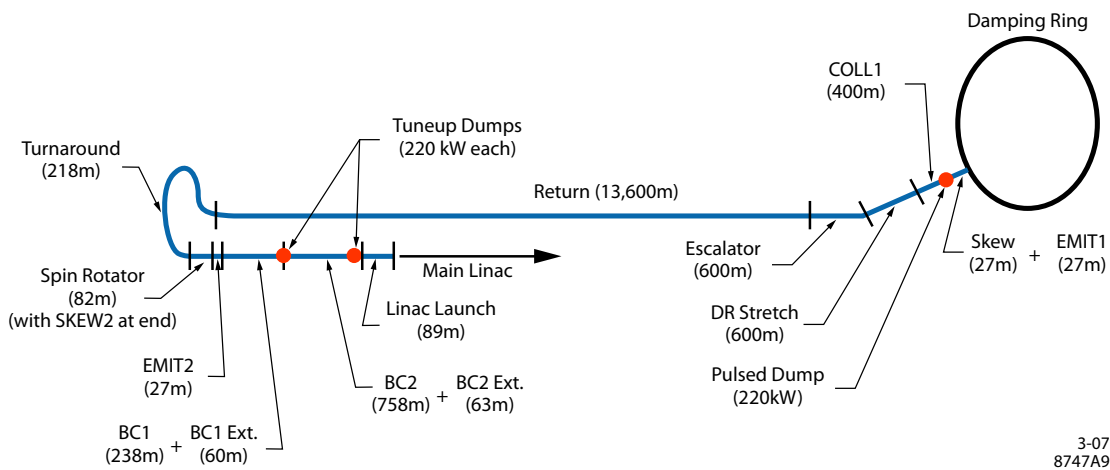

FIGURE 2.9. Schematic of the RTML.

System Description

The layout of the RTML is identical for both electrons and positrons, and is shown in Figure 2.9. The RTML consists of the following subsystems:

- an ~ 15 km long 5 GeV transport line;
- betatron and energy collimation systems;
- a 180° turn-around, which enables feed-forward beam stabilization;
- spin rotators to orient the beam polarization to the desired direction;
- a 2-stage bunch compressor to compress the beam bunch length from several millimeters to a few hundred microns as required at the IP.

The bunch compressor includes acceleration from 5 GeV to 13-15 GeV in order to limit the increase in fractional energy spread associated with bunch compression.

Challenges

The principal challenges in the RTML are:

- control of emittance growth due to static misalignments, resulting in dispersion and coupling. Simulations indicate that the baseline design for beam-based alignment can limit the emittance growth to tolerable levels.
- suppression of phase and amplitude jitter in the bunch compressor RF, which can lead to timing errors at the IP. RMS phase jitter of 0.24° between the electron and positron RF systems results in a 2% loss of luminosity. Feedback loops in the bunch compressor low-level RF system should be able to limit the phase jitter to this level.

2.2.6 Main Linacs

Functional requirements

The two main linacs accelerate the electron and positron beams from their injected energy of 15 GeV to the final beam energy of 250 GeV, over a combined length of 23 km. The main linacs must:

- accelerate the beam while preserving the small bunch emittances, which requires precise orbit control based on data from high resolution beam position monitors, and also requires control of higher-order modes in the accelerating cavities;
- maintain the beam energy spread within the design requirement of $\sim 0.1\%$ at the IP;
- not introduce significant transverse or longitudinal jitter, which could cause the beams to miss at the collision point.

System description

The ILC Main Linacs accelerate the beam from 15 GeV to a maximum energy of 250 GeV at an average accelerating gradient of 31.5 MV/m. The linacs are composed of RF units, each of which are formed by three contiguous SCRF cryomodules containing 26 nine-cell cavities. The layout of one unit is illustrated in Figure 2.10. The positron linac contains 278 RF units, and the electron linac has 282 RF units⁴.

⁴Approximately 3 GeV of extra energy is required in the electron linac to compensate for positron production.

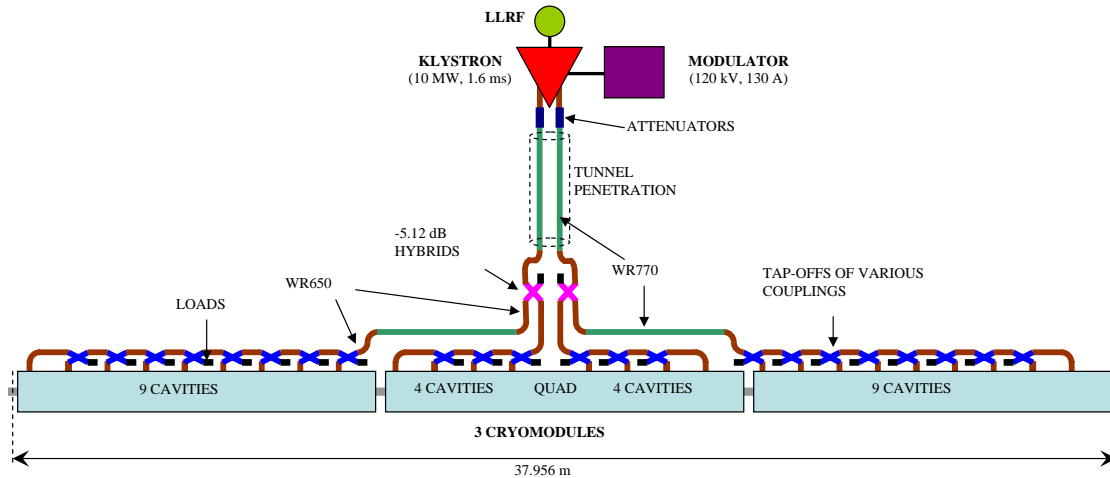

FIGURE 2.10. RF unit layout.

Each RF unit has a stand-alone RF source, which includes a conventional pulse-transformer type high-voltage (120 kV) modulator, a 10 MW multi-beam klystron, and a waveguide system that distributes the RF power to the cavities (see Figure 2.10). It also includes the low-level RF (LLRF) system to regulate the cavity field levels, interlock systems to protect the source components, and the power supplies and support electronics associated with the operation of the source.

The cryomodule design is a modification of the Type-3 version (Figure 2.2) developed and used at DESY. Within the cryomodules, a 300 mm diameter helium gas return pipe serves as a strongback to support the cavities and other beam line components. The middle cryomodule in each RF unit contains a quad package that includes a superconducting quadrupole magnet at the center, a cavity BPM, and superconducting horizontal and vertical corrector magnets. The quadrupoles establish the main linac magnetic lattice, which is a weak focusing FODO optics with an average beta function of ~ 80 m. All cryomodules are 12.652 m long, so the active-length to actual-length ratio in a nine-cavity cryomodule is 73.8%. Every cryomodule also contains a 300 mm long high-order mode beam absorber assembly that removes energy through the 40-80 K cooling system from beam-induced higher-order modes above the cavity cutoff frequency.

To operate the cavities at 2 K, they are immersed in a saturated He II bath, and helium gas-cooled shields intercept thermal radiation and thermal conduction at 5-8 K and at 40-80 K. The estimated static and dynamic cryogenic heat loads per RF unit at 2 K are 5.1 W and 29 W, respectively. Liquid helium for the main linacs and the RTML is supplied from 10 large cryogenic plants, each of which has an installed equivalent cooling power of ~ 20 kW at 4.5 K. The main linacs follow the average Earth's curvature to simplify the liquid helium transport.

The Main Linac components are housed in two tunnels, an accelerator tunnel and a service tunnel, each of which has an interior diameter of 4.5 meters. To facilitate maintenance and limit radiation exposure, the RF source is housed mainly in the service tunnel as illustrated in Figure 2.11.

The tunnels are typically hundreds of meters underground and are connected to the surface through vertical shafts⁵. Each of the main linacs includes three shafts, roughly 5 km apart

⁵Except for the Asian sample site: see Section 2.3.

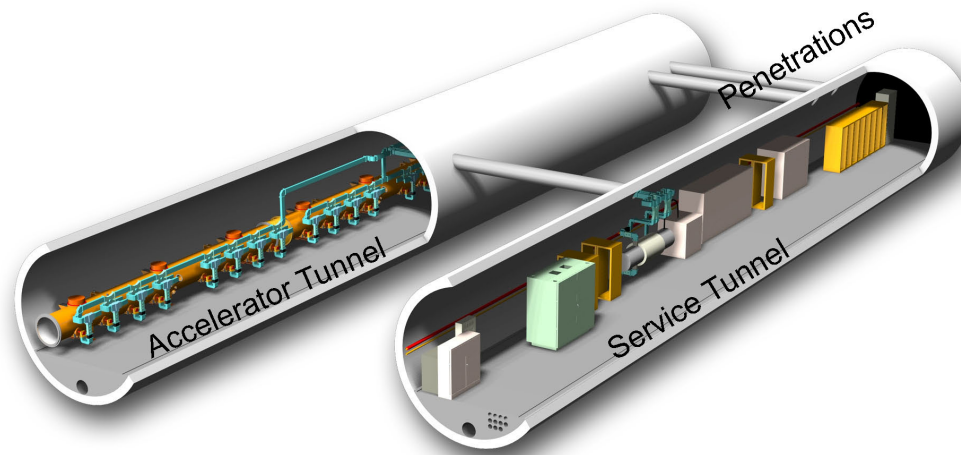

FIGURE 2.11. Cutaway view of the linac dual-tunnel configuration.

as dictated by the cryogenic system. The upstream shafts in each linac have diameters of 14 m to accommodate lowering cryomodules horizontally, and the downstream shaft in each linac is 9 m in diameter, which is the minimum size required to accommodate tunnel boring machines. At the base of each shaft is a 14,100 cubic meter cavern for staging installation; it also houses utilities and parts of the cryoplant, most of which are located on the surface.

Challenges

The principal challenges in the main linac are:

- achieving the design average accelerating gradient of 31.5 MV/m. This operating gradient is higher than that typically achievable today and assumes further progress will be made during the next few years in the aggressive program that is being pursued to improve cavity performance.
- control of emittance growth due to static misalignments, resulting in dispersion and coupling. Beam-based alignment techniques should be able to limit the single-bunch emittance growth. Long-range multibunch effects are mitigated via HOM damping ports on the cavities, HOM absorbers at the quadrupoles, and HOM detuning. Coupling from mode-rotation HOMs is limited by splitting the horizontal and vertical betatron tunes.
- control of the beam energy spread. The LLRF system monitors the vector sum of the fields in the 26 cavities of each RF unit and makes adjustments to flatten the energy gain along the bunch train and maintain the beam-to-RF phase constant. Experience from FLASH and simulations indicate that the baseline system should perform to specifications.

2.2.7 Beam Delivery System

Functional requirements

The ILC Beam Delivery System (BDS) is responsible for transporting the e^+e^- beams from the exit of the high energy linacs, focusing them to the sizes required to meet the ILC luminosity goals, bringing them into collision, and then transporting the spent beams to the main beam dumps. In addition, the BDS must perform several other critical functions:

- measure the linac beam and match it into the final focus;
- protect the beamline and detector against mis-steered beams from the main linacs;
- remove any large amplitude particles (beam-halo) from the linac to minimize background in the detectors;
- measure and monitor the key physics parameters such as energy and polarization before and after the collisions.

System Description

The layout of the beam delivery system is shown in Figure 2.12. There is a single collision point with a 14 mrad total crossing angle. The 14 mrad geometry provides space for separate extraction lines but requires crab cavities to rotate the bunches in the horizontal plane for effective head-on collisions. There are two detectors in a common interaction region (IR) hall in a so-called “push-pull” configuration. The detectors are pre-assembled on the surface and then lowered into the IR hall when the hall is ready for occupancy.

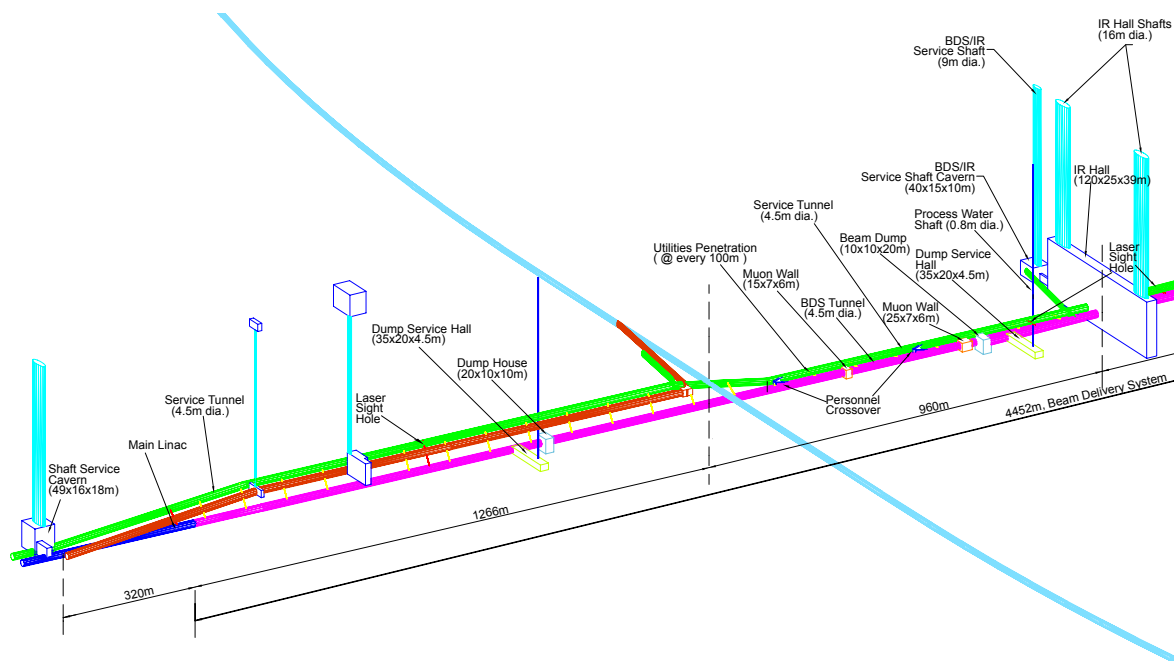

FIGURE 2.12. BDS layout, beam and service tunnels (shown in magenta and green), shafts, experimental hall. The line crossing the BDS beamline at right angles is the damping ring, located 10 m above the BDS tunnels.

The BDS is designed for 500 GeV center-of-mass energy but can be upgraded to 1 TeV with additional magnets.

The main subsystems of the beam delivery, starting from the exit of the main linacs, are:

- a section containing post-linac emittance measurement and matching (correction) sections, trajectory feedback, polarimetry and energy diagnostics;
- a fast pulsed extraction system used to extract beams in case of a fault, or to dump the beam when not needed at the IP;

THE ILC ACCELERATOR

- a collimation section which removes beam halo particles that would otherwise generate unacceptable background in the detector, and also contains magnetized iron shielding to deflect muons;
- the final focus (FF) which uses strong compact superconducting quadrupoles to focus the beam at the IP, with sextupoles providing local chromaticity correction;
- the interaction region, containing the experimental detectors. The final focus quadrupoles closest to the IP are integrated into the detector to facilitate detector “push-pull”;
- the extraction line, which has a large enough bandwidth to cleanly transport the heavily disrupted beam to a high-powered water-cooled dump. The extraction line also contains important polarization and energy diagnostics.

Challenges

The principal challenges in the beam delivery system are:

- tight tolerances on magnet motion (down to tens of nanometers), which make the use of fast beam-based feedback systems mandatory, and may well require mechanical stabilization of critical components (e.g. final doublets).
- uncorrelated relative phase jitter between the crab cavity systems, which must be limited to the level of tens of femtoseconds.
- control of emittance growth due to static misalignments, which requires beam-based alignment and tuning techniques similar to the RTML.
- control of backgrounds at the IP via careful tuning and optimization of the collimation systems and the use of the tail-folding octupoles.
- clean extraction of the high-powered disrupted beam to the dump. Simulations indicate that the current design is adequate over the full range of beam parameters.

2.3 SAMPLE SITES

Conventional Facilities and Siting (CFS) is responsible for civil engineering, power distribution, water cooling and air conditioning systems. The value estimate (see Section 4) for the CFS is approximately 38% of the total estimated project value.

In the absence of a single agreed-upon location for the ILC, a sample site in each region was developed. Each site was designed to support the baseline design described in Section 2.2. Although many of the basic requirements are identical, differences in geology, topography and local standards and regulations lead to different construction approaches, resulting in a slight variance in value estimates across the three regions. Although many aspects of the CFS (and indeed machine design) will ultimately depend on the specific host site chosen, the approach taken here is considered sufficient for the current design phase, while giving a good indication of the influence of site-specific issues on the project as a whole.

Early in the RDR process, the regional CFS groups agreed upon a matrix of criteria for any sample site. All three sites satisfied these criteria, including the mandatory requirement that the site can support the extension to the 1 TeV center-of-mass machine.

The three sample sites have the following characteristics:

- The Americas sample site lies in Northern Illinois near Fermilab. The site provides a range of locations to position the ILC in a north-south orientation. The site chosen

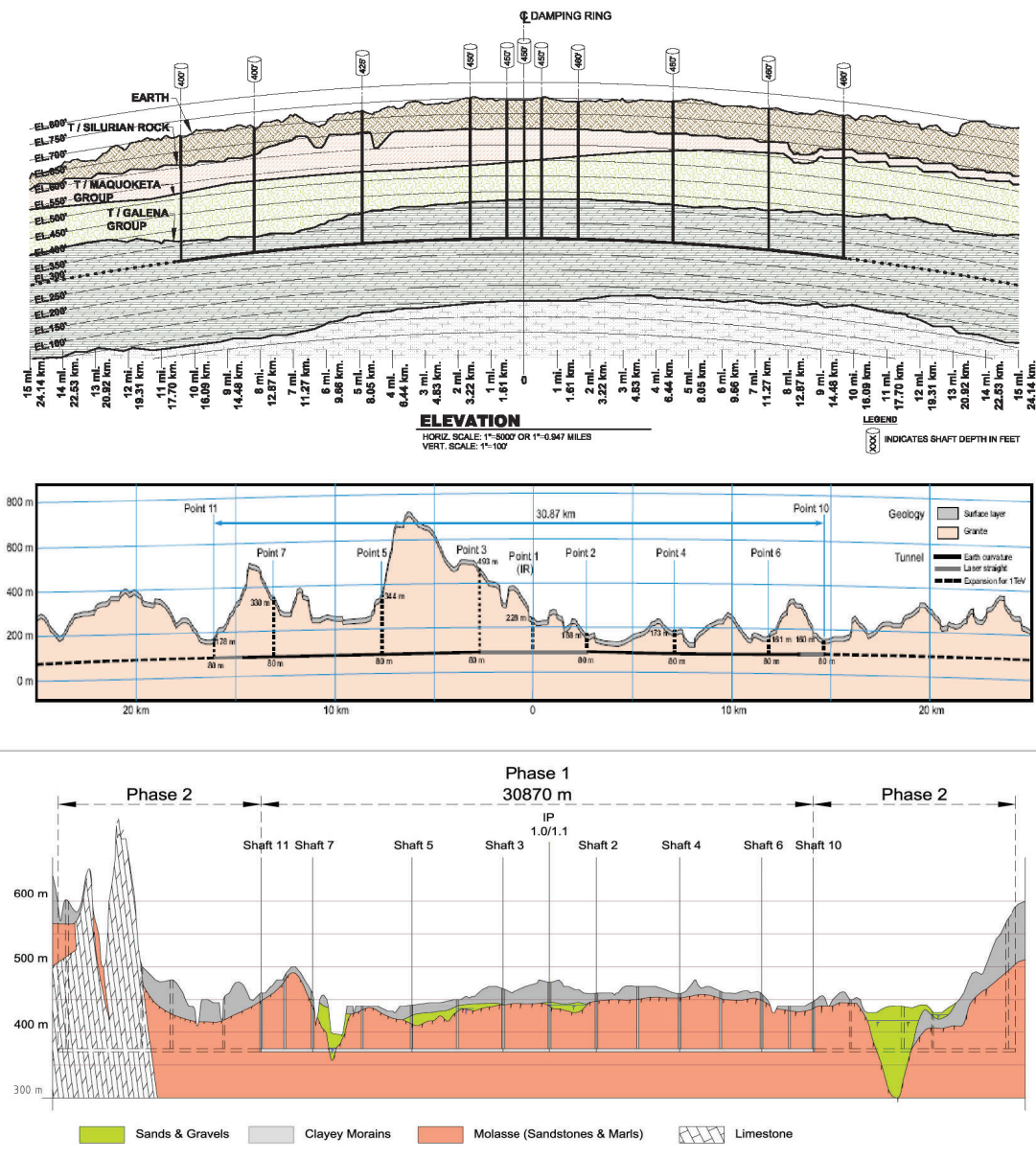

FIGURE 2.13. Geology and tunnel profiles for the three regional sites, showing the location of the major access shafts (tunnels for the Asian site). Top: the Americas site close to Fermilab. Middle: the Asian site in Japan. Bottom: the European site close to CERN.

has approximately one-quarter of the machine on the Fermilab site. The surface is primarily flat. The long tunnels are bored in a contiguous dolomite rock strata (Galena Platteville), at a typical depth of 30-100 m below the surface.

- The Asian site has been chosen from several possible ILC candidate sites in Japan. The sample site has a uniform terrain located along a mountain range, with a tunnel depth ranging from 40 m to 600 m. The chosen geology is uniform granite highly suited to modern tunneling methods. One specific difference for the Asian site is the use of long sloping access tunnels instead of vertical shafts, the exception being the experimental hall at the Interaction Region, which is accessed via two 112 m deep vertical shafts. The sloping access tunnels take advantage of the mountainous location.

THE ILC ACCELERATOR

- The European site is located at CERN, Geneva, Switzerland, and runs parallel to the Jura mountain range, close to the CERN site. The majority of the machine is located in the ‘Molasse’ (a local impermeable sedimentary rock), at a typical depth of 370 m.

The elevations of the three sample sites are shown in Figure 2.13. The tunnels for all three sites would be predominantly constructed using Tunnel Boring Machines (TBM), at typical rates of 20–30 m per day. The Molasse of the European site near CERN requires a reinforced concrete lining for the entire tunnel length. The Asian site (granite) requires rock bolts and a 5 cm ‘shotcrete’ lining. The US site is expected to require a concrete lining for only approximately 20% of its length, with rock-bolts being sufficient for permanent structural support.

A second European sample site near DESY, Hamburg, Germany, has also been developed. This site is significantly different from the three reported sites, both in geology and depth (25 m deep), and requires further study.

In addition, the Joint Institute for Nuclear Research has submitted a proposal to site the ILC in the neighborhood of Dubna, Russian Federation.

The three sites reported in detail here are all ‘deep-tunnel’ solutions. The DESY and Dubna sites are examples of ‘shallow’ sites. A more complete study of shallow sites – shallow tunnel or cut-and-cover – will be made in the future as part of the Engineering Design phase.

CHAPTER 3

Detectors

The challenge for the ILC detectors is to optimize the scientific results from a broad experimental program aimed at understanding the mechanism of mass generation and electroweak symmetry breaking. This includes the search for supersymmetric particles, and their detailed study if they are found, and the hunt for signs of extra space-time dimensions and quantum gravity. Precision measurements of Standard Model processes can reveal new physics at energy scales beyond direct reach. The detectors must also be prepared for the unexpected.

Experimental conditions at the ILC provide an ideal environment for the precision study of particle production and decay, and offer the unparalleled cleanliness and well-defined initial conditions conducive to recognizing new phenomena. Events are recorded without trigger bias, with detectors designed for optimal physics performance. The physics poses challenges, pushing the limits of jet energy resolution, tracker momentum resolution, and vertex impact parameter resolution. Multi-jet final states and supersymmetry (SUSY) searches put a premium on hermeticity and full solid angle coverage. Although benign by LHC standards, the ILC environment poses challenges of its own.

The World Wide Study of Physics and Detectors for Future Linear Colliders has wrestled with these challenges for more than a decade, advancing the technologies needed for ILC detectors. Different concepts for detectors have evolved[12, 17], as the rapid collider progress has spurred the experimental community. Four concept reports[18, 19, 20, 21] were presented in Spring, 2006. All of these detectors meet the ILC physics demands, and can be built with technologies that are within reach today. There is a growing community involved in refining and optimizing these designs, and advancing the technologies. Full detector engineering designs and proof of principle technology demonstrations can be completed on the timetable proposed for the ILC Engineering Design Report as long as there is adequate support for detector R&D and integrated detector studies.

3.1 CHALLENGES FOR DETECTOR DESIGN AND TECHNOLOGY

The relatively low radiation environment of the ILC allows detector designs and technologies not possible at the LHC, but the demanding physics goals still challenge the state of the art, particularly in readout and sensor technologies.

Many interesting ILC physics processes appear in multi-jet final states, often accompanied

by charged leptons or missing energy. Precision mass measurements require a jet energy resolution of $\frac{\sigma_{E_{jet}}}{E_{jet}} = \frac{30\%}{\sqrt{E_{jet}}}$ for E_{jet} up to approximately 100 GeV, and $\frac{\sigma_{E_{jet}}}{E_{jet}} \leq 3\%$ beyond, more than a factor of 2 better than achieved at LEP/SLC.

Detailed studies of leptons from W and Z decays require efficient electron and muon ID and accurate momentum measurements over the largest possible solid angle. Excellent identification of electrons and muons within jets is critical because they indicate the presence of neutrinos from heavy quark decays, and tag the jet flavor and quark charge.

The jet mass resolution appears achievable if the detector has an excellent, highly efficient, nearly hermetic tracking system and a finely segmented calorimeter. Charged tracks reconstructed in the tracker can be isolated in the calorimeter, and their contributions removed from the calorimeter energy measurement. This “particle flow” concept has motivated the development of high granularity calorimeters, and highly efficient tracking systems. The main challenge is the separation of neutral and charged contributions within a dense jet environment.

It is possible to satisfy the calorimeter granularity required for the particle flow concept with electromagnetic cell sizes of about $1 \times 1 \text{ cm}^2$, and comparable or somewhat larger hadronic cells. An electromagnetic energy resolution of $\sim 15\%/\sqrt{E}$ and a hadronic resolution of $\sim 40\%/\sqrt{E}$ is sufficient.

The momentum resolution required to satisfy the demands of particle flow calorimetry and missing energy measurements is particularly challenging and exceeds the current state of the art. Good momentum resolution from the beam energy down to very low momentum is needed over the full solid angle. Pattern recognition must be robust and highly efficient even in the presence of backgrounds. This requires minimal material to preserve lepton ID and permit high performance calorimetry.

“Higgs-strahlung” production in association with a Z is a particularly powerful physics channel. It allows precision Higgs mass determination, precision studies of the Higgs branching fractions, measurement of the production cross section and accompanying tests of SM couplings, and searches for invisible Higgs decays. The resolution of the recoil mass from a Z decaying to leptons depends on beam energy accuracy, beam energy spread and tracking precision. Figure 3.1 shows an example of the recoil mass distribution[22] opposite the Z. The tracker is also critical to mass determination of kinematically accessible sleptons and neutralinos, and accurate measurements of the center of mass energy.

Vertex detection identifies heavy particle decay vertices, enabling flavor and charge tagging. Multilayer vertex detection also provides efficient stand-alone pattern recognition, momentum measurement for soft tracks, and seeds for tracks in outer trackers. The ILC physics goals push vertex detector efficiency, angular coverage, and impact parameter resolution beyond the current state of the art, even surpassing the SLD CCD vertex detector[23]. The ILC beamstrahlung e^+e^- pairs present a background of up to 100 hits/mm²/train for the innermost detector elements. It is essential to reduce the number of background hits, either by time-slicing the bunch train into pieces of less than 150 bunch crossings, or by discriminating charged tracks from background. The simultaneous challenges of rapid readout, constrained power budget, transparency and high resolution are being actively addressed by several efforts. The ILCs low data rates and low radiation loads allow consideration of new technologies that reach beyond LHC capabilities.

The very forward region of the ILC detector is instrumented with a calorimeter (BeamCal) that extends calorimeter hermeticity to small angles. To search for new particles, this instru-

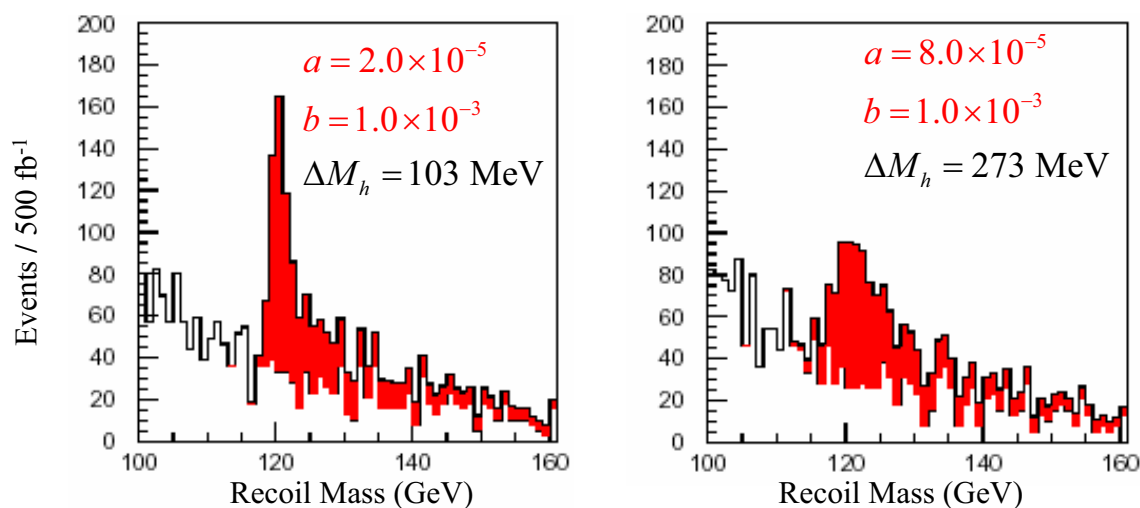

FIGURE 3.1. Higgs recoil mass spectra for tracker momentum resolution, $\frac{\delta p_t}{p_t} = a \oplus \frac{b}{p_t \sin \theta}$, for 120 GeV Higgs mass, $\sqrt{s} = 350$ GeV, and 500 fb^{-1} .

ment must veto electrons in a high radiation and high background environment. Measurement of the energy deposited by beamstrahlung pairs and photons in the BeamCal and associated photon calorimeter (GamCal) provides a bunch-by-bunch luminosity measurement that can be used for intra-train luminosity optimization. Beam parameters can also be determined from the shapes of the observed energy depositions given sufficiently fast readout electronics and adequate high bandwidth resolution. Near the beampipe the absorbed radiation dose is up to 10 MGy per year.

Polarimetry and beam energy spectrometry must be able to achieve very low systematic errors, with beam energy measured to 200 ppm, and polarization to 0.1%. High-field superconducting solenoid designs must be refined, with development of new conductors. The solenoid design must also accommodate dipole and solenoid compensation, have high field uniformity, and support push-pull. Muon detectors must be developed.

Detector system integration depends on engineering and design work in several areas. Stable, adjustable, vibration free support of the final quadrupoles is needed. Support of the fragile beampipe with its massive masking is also a concern. The detectors are required to move on and off beamline quickly and reproducibly (“push-pull”). The detectors must be calibrated, aligned, and accessed, without compromising performance.

Research and development on all of these detector issues must be expanded in order to achieve the needed advances.

3.2 DETECTOR CONCEPTS

Four detector concepts are being studied as candidate detectors for the ILC experimental program. These represent complementary approaches and technology choices. Each concept is designed with an inner vertex detector, a tracking system based on either a gaseous Time Projection Chamber or silicon detectors, a calorimeter to reconstruct jets, a muon system, and a forward system of tracking and calorimetry. Table 3.1 presents some of the key parameters

DETECTORS

of each of the four detector concepts. GLD, LDC and SiD employ particle flow for jet energy measurements. SiD has the strongest magnetic field and the smallest radius, while LDC and GLD rely on smaller fields with larger tracking radii. Each approach uses different emphasis to address the optimization. The 4th concept employs a dual-readout fiber calorimeter and a novel outer muon system.

TABLE 3.1
Some key parameters of the four detector concepts.

| Concept | Tracking Technology | Solenoidal Field Strength (Tesla) | Solenoid Radius, Length (m) | Vertex Inner Radius (mm) | ECAL Barrel Inner Radius, Half-Length (m) | Overall Detector Outer Radius, Half-Length (m) |
|-----------------|---------------------|-----------------------------------|-----------------------------|--------------------------|---|--|
| GLD | TPC/Si | 3 | 4 | 20 | 2.1 | 7.20 |
| | | | 9.5 | | 2.8 | 7.50 |
| LDC | TPC/Si | 4 | 3 | 16 | 1.60 | 6.00 |
| | | | 6.6 | | 2.3 | 6.20 |
| SiD | Silicon | 5 | 2.5 | 14 | 1.27 | 6.45 |
| | | | 5.5 | | 1.27 | 5.89 |
| 4 th | TPC or drift | 3.5 | 3 | 15 | 1.5 | 5.50 |
| | | | 8 | | 1.8 | 6.50 |

Software models of the detectors have produced realistic simulations of the physics performance, making it clear that the detectors can do the physics. The community is also preparing for the evolution to collaborations.

3.2.1 The Silicon Detector (SiD) Concept

The SiD concept is based on silicon tracking and a silicon-tungsten sampling calorimeter, complemented by a powerful pixel vertex detector, outer hadronic calorimeter, and muon system. Silicon detectors are fast and robust, and can be finely segmented. Most SiD systems can record backgrounds from a single bunch crossing accompanying a physics event, maximizing event cleanliness. The vertex detector, the tracker and the calorimeter can all absorb significant radiation bursts without “tripping” or sustaining damage, maximizing running efficiency. The SiD Starting Point[18] is illustrated in Figure 3.2.

A highly pixellated silicon-tungsten electromagnetic calorimeter and a multilayer, highly segmented hadron calorimeter, inside the solenoid, are chosen to optimize particle flow calorimetry. Cost and performance considerations dictate a 5 Tesla solenoid, at relatively small radius.

SiD tracking works as an integrated system, incorporating the pixellated vertex detector (5 barrels and 4 endcap layers), the central silicon microstrip tracker (5 layers, barrels and endcaps), and the electromagnetic calorimeter. The vertex detector plays a key role in pattern

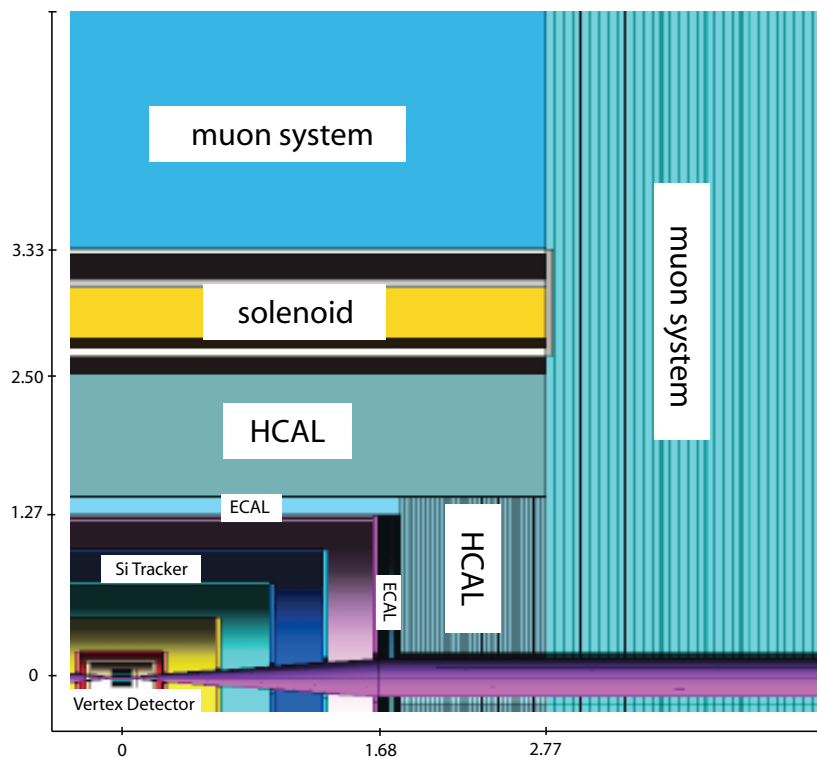

FIGURE 3.2. Illustration of a quadrant of SiD.

recognition; tracks produced by decays beyond the second layer of the central tracker, but within the ECAL, are captured with a calorimeter-assisted tracking algorithm. The resolution of the combined system is $\frac{\sigma_p}{p^2} < 2 \times 10^{-5} \text{ GeV}^{-1}$ at high momentum.

The SiD electromagnetic calorimeter consists of layers of tungsten and large-area silicon diode detectors in one mm gaps. The hadronic calorimeter sandwich employs steel absorber plates and resistive plate chambers (RPCs). Options include tungsten absorber, glass RPCs, GEM foils, Micromegas, and scintillating tiles with silicon photomultipliers. Muon detectors (following 6λ at 3.5 m radius) fill some gaps between iron plates of the flux return. Two technologies are under consideration for the muon system, strip-scintillator detectors and RPCs.

3.2.2 The Large Detector Concept (LDC)

The LDC[19] is based on a precision, highly redundant and reliable Time Projection Chamber (TPC) tracking system, and particle flow as a means to complete event reconstruction, all inside a large volume magnetic field of up to 4 Tesla, completed by a precision muon system covering nearly the complete solid angle outside the coil. A view of the simulated detector is shown in Figure 3.3 (left).

The TPC provides up to 200 precise measurements along a track, supplemented by Si-based tracking detectors. A silicon vertex detector gives unprecedented precision in the reconstruction of long lived particles.

The proposed LDC detector has the following components:

- a five layer pixel-vertex detector
- a system of silicon strip and pixel detectors extending the vertex detector

DETECTORS

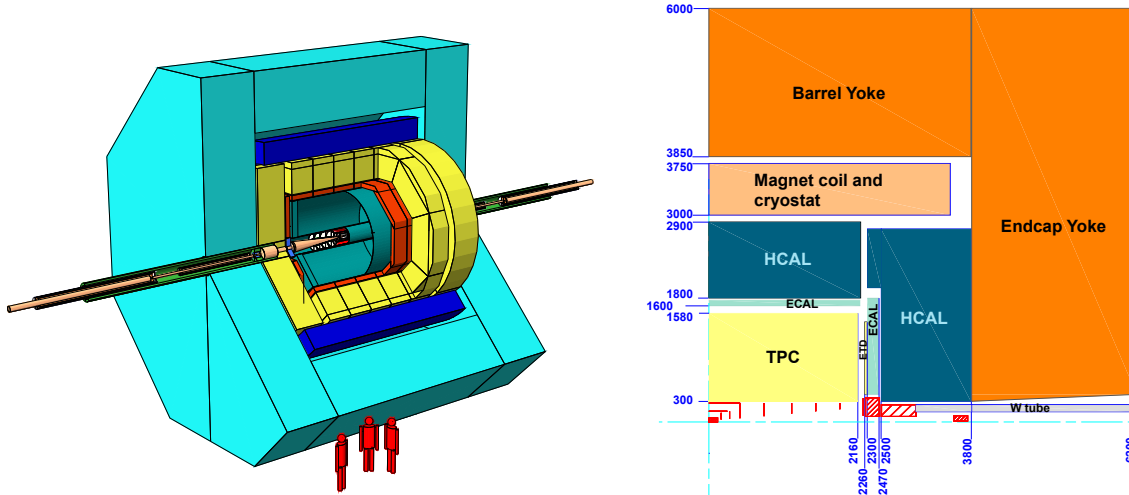

FIGURE 3.3. View of the LDC detector concept, as simulated with the MOKKA simulation package (left). 1/4 view of the LDC detector concept (right).

- a large volume TPC
 - a system of “linking” detectors behind the endplate of the TPC and in between the TPC outer radius and the ECAL inner radius
 - a granular Si-W electromagnetic calorimeter
 - a granular Fe-Scintillator hadronic calorimeter, gas hadronic calorimeter is an option
 - a system of high precision extremely radiation hard calorimetric detectors in the very forward region, to measure luminosity and to monitor collision quality
 - a large volume superconducting coil, with longitudinal B-field of 4 Tesla
 - an iron return yoke, instrumented to serve as a muon filter and detector.
- A schematic view of one quarter of this detector is shown in Figure 3.3 (right).

3.2.3 The GLD Concept

The GLD detector[20] concept has a large gaseous tracker and finely granulated calorimeter within a large bore 3 Tesla solenoid. Figure 3.4 shows a schematic view of two different quadrants of the baseline design of GLD.

The baseline design has the following sub-detectors:

- a Time Projection Chamber as a large gaseous central tracker
- a highly segmented electromagnetic calorimeter placed at large radius and based on a tungsten-scintillator sandwich structure
- a highly segmented hadron calorimeter with a lead-scintillator sandwich structure and radial thickness of $\sim 6\lambda$
- forward electromagnetic calorimeters which provide nearly full solid angle coverage down to very forward angles
- a precision silicon (FPCCD) micro-vertex detector
- silicon inner and endcap trackers
- a beam profile monitor in front of a forward electromagnetic calorimeter
- a scintillator strip muon detector interleaved with the iron plates of the return yoke
- a solenoidal magnet to generate the 3 Tesla magnetic field.

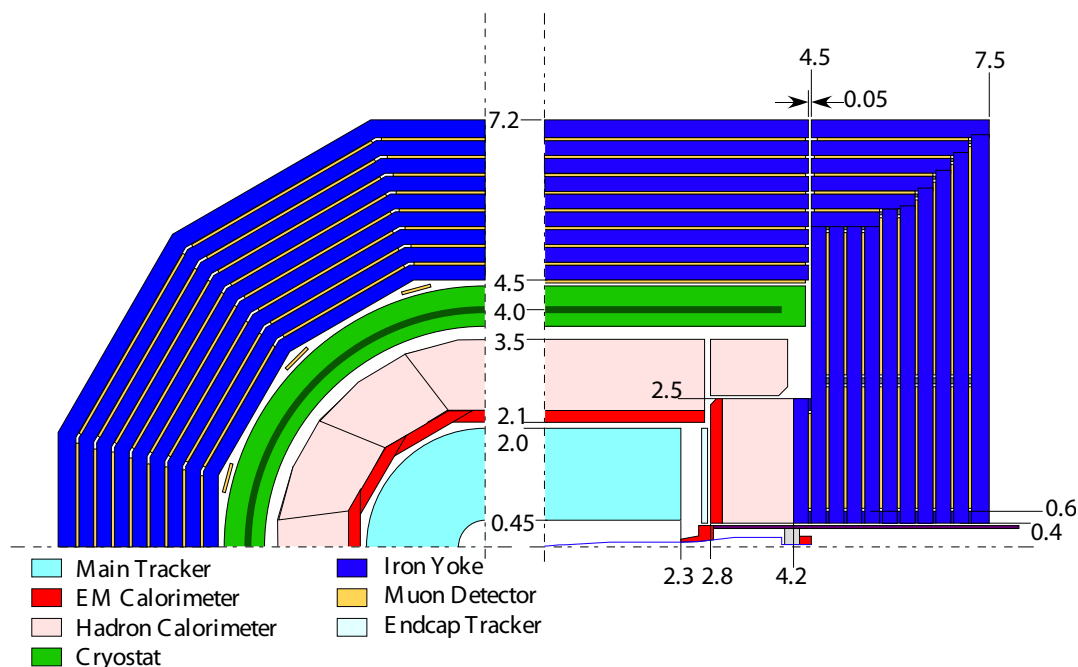

FIGURE 3.4. Schematic view of two different quadrants of the GLD Detector. The left figure shows the ϕ view and the right shows the rz view. Dimensions are given in meters. The vertex detector and the silicon inner tracker are not shown.

3.2.4 Fourth Concept (“4th”) Detector

The Fourth Concept detector[21] consists of four essential detector systems. The calorimeter is a spatially fine-grained dual-readout fiber sampling calorimeter augmented with the ability to measure the neutron content of a shower. The dual fibers are scintillation and Cerenkov for separation of hadronic and electromagnetic components of hadronic showers[24]. A separate crystal calorimeter with dual readout in front of the fiber calorimeter is being studied.

The muon system is a dual-solenoid magnetic field configuration in which the flux from the inner solenoid is returned through the annulus between this inner solenoid and an outer solenoid. The magnetic field between the two solenoids back-bends the muons for a second measurement of the momentum (with drift tubes after the calorimeter).

The iron-free magnetic field is confined to a cylinder with negligible fringe fields and with the capability to control the fields at the beam. The twist compensation solenoid just outside the wall of coils is shown in Figure 3.5 (right). The iron-free configuration may allow mounting of all beam line elements on a single support, which could reduce the effect of vibrations at the final focus (FF) as the beams move coherently up and down together. In addition, the FF elements can be brought close to the vertex chamber for better control of the beam crossing. The iron-free magnetic field configuration allows any crossing angle.

The pixel vertex detector is the SiD detector design. The Time Projection Chamber (TPC) is very similar to those being developed by the GLD and LDC concepts.

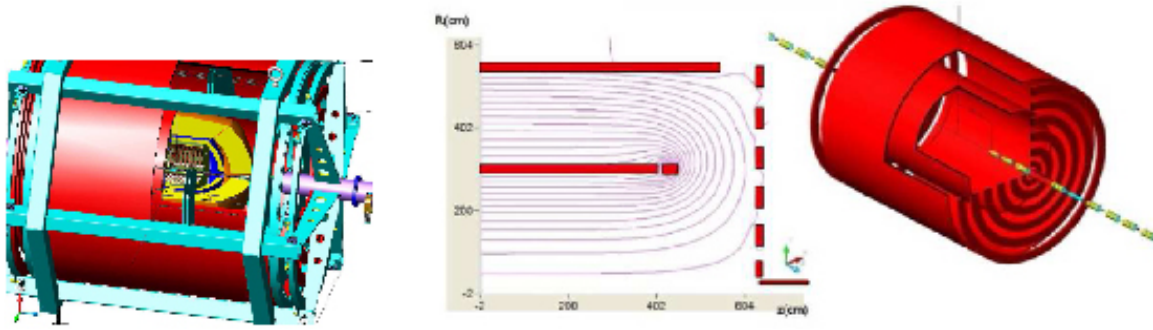

FIGURE 3.5. Cut-away view of the 4th Detector (left). Drawings showing the two solenoids and the “wall of coils” and resulting field lines in an r-z view (right). This field is uniform to 1% at 3.5 T in the TPC tracking region, and also uniform and smooth at -1.5 T in the muon tracking annulus between the solenoids.

3.3 DETECTOR AND PHYSICS PERFORMANCE

Significant progress has been made in the development of complete simulation and reconstruction software systems for the ILC detectors, lending reality and credibility to studies of detector performance and physics studies. These are available in software repositories[25].

The detectors have tracking systems composed of a number of different sub-systems. Using realistic algorithms, and including a simulation of the expected background rates, track reconstruction efficiencies close to 99% have been demonstrated, with momentum resolutions of $\frac{\sigma_{p_t}}{p_t} < 1 \times 10^{-4} \text{ GeV}^{-1}$.

Below 1 TeV the best event reconstruction resolution is believed to result from a particle flow algorithm. Simulations have shown jet-energy resolutions are near the goal of $\frac{\sigma_{E_{jet}}}{E_{jet}} = \frac{30\%}{\sqrt{E_{jet}}}$ for E_{jet} up to approximately 100 GeV, and $\frac{\sigma_{E_{jet}}}{E_{jet}} \leq 3\%$ beyond. Table 3.2 presents some recent results for jet energy resolution using particle flow in detailed, realistic simulations [26].

TABLE 3.2
Jet energy resolutions based on simulations of LDC.

| E_{jet} | $\sigma_{E_{jet}}$ |
|-----------|--------------------|
| 45 GeV | 4.4% |
| 100 GeV | 3.0% |
| 180 GeV | 3.1% |
| 250 GeV | 3.4% |

Figure 3.6 presents a calculation of the energy rms for 90% of $\sqrt{s} = 91.2 \text{ GeV}$ events (RMS90) as a function of the production angle of the jets for GLD. In the barrel the averaged energy resolution is 2.97 GeV, which corresponds to 3.3%.

Particle Flow Algorithm (PFA) resolution is expected to improve as the calorimeter radius and magnetic field increase. In order to achieve the PFA performance goal with an acceptable detector cost, SiD adopts the strongest magnetic field with the smallest radius, GLD the

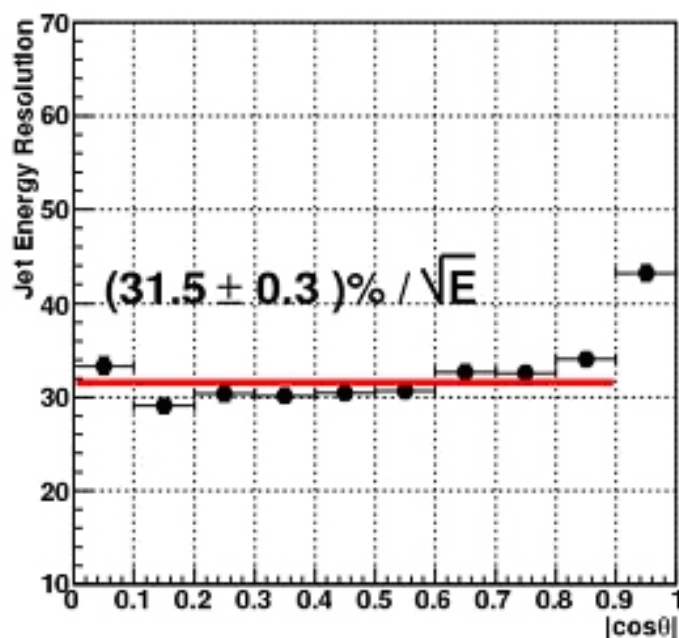

FIGURE 3.6. Energy resolution for 90% of events (RMS90) as a function of $|\cos\theta_q|$ for $e^+e^- \rightarrow q\bar{q}$ (light quarks) events at $\sqrt{s} = 91.2$ GeV in the GLD detector.

weakest magnetic field but the largest radius, with LDC in between. The performances as a function of TPC radius for a few magnetic field values are shown in Figure 3.7. As expected, the jet energy resolution improves with increasing calorimeter radius when the magnetic field is fixed.

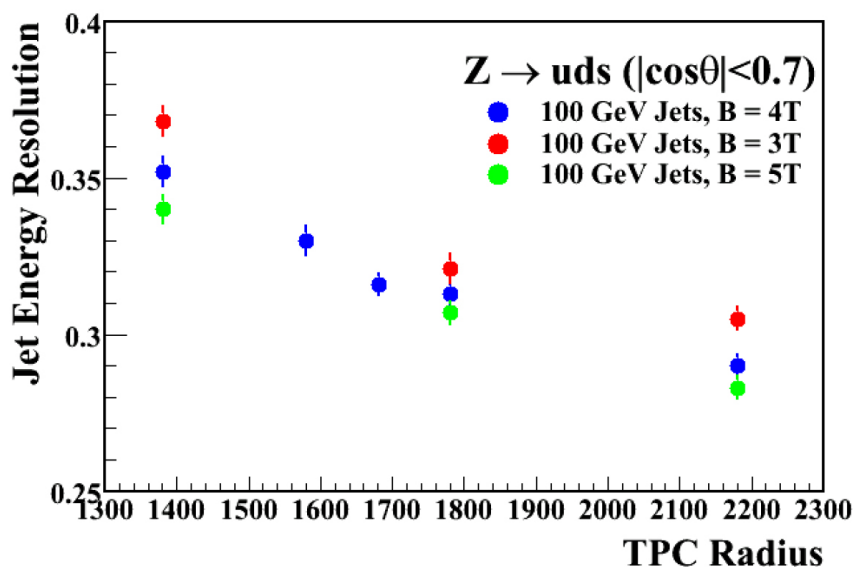

FIGURE 3.7. The jet energy resolution expressed as $\sigma_{jet}\sqrt{E_{jet}}$, as a function of the TPC radius for a few magnetic field values. The TPC radius is equivalent to the inner radius of calorimeter.

Study of Higgs boson properties could be a major focus of the ILC physics program. The challenging measurement of the Higgs mass using the recoil mass method is presented in

Figure 3.1. In a related study, the precision on the mass measurement for a 120 GeV Higgs boson at $\sqrt{s} = 350$ GeV is shown to be 135 MeV with SiD.

3.4 INTERFACING THE DETECTOR TO THE MACHINE

The interaction region is the interface between the detector and the accelerator. Its complexity motivates integration of the beam delivery system with the detector design.

The beams are delivered through the largest possible apertures en route to the collision point, but are constrained to pass through a beampipe of minimal radius at the IP to optimize vertex detector performance. A series of detectors record the remnants from the beam interactions in the very forward direction, monitor the beam properties, and measure the delivered luminosity. Tungsten masks shield most of the detector from the backgrounds produced in the collision.

Several beam processes create backgrounds which are potentially problematic for the detector. The main background is large numbers of very forward going photons and electron-positron pairs produced by “beamstrahlung”. Other backgrounds include synchrotron radiation, muons produced upstream of the IR when beam tails impinge on collimators, and neutrons created by the absorption of beamstrahlung photons and pairs on beamline elements.

To guide the disrupted beam and charged background particles out of the detector and to minimize backgrounds, the detector magnetic field is perturbed to point in the direction of the outgoing beam. This is done by superposing a small dipole field on the detector’s main solenoidal field. This Detector Integrated Dipole (DID) is beneficial once the crossing angle increases beyond a few mrad.

The detectors most sensitive to pair backgrounds are the vertex detector and the beamcal. The innermost layer of the vertex detector sits between 1.3 and 1.55 cm from the interaction point, and must contend with ~ 100 particles/mm²/bunch train, which generates high occupancies. The beamcal must contend with an energy deposition of 100 TeV/ beam crossing, which results in a high radiation dose. The number of particles passing outside the vertex detector, at radii beyond 10 cm, is rather small. For a silicon based tracking system it is not a real concern. In a TPC based tracking system, where many bunches are integrated into one image of the tracker, the total occupancy is expected to be below one percent, and is not a problem.

The ILC reference design has one interaction region with beams crossing at 14 mrad, and is equipped with two detectors which can be moved quickly into and out of the interaction region (push-pull operation) to share luminosity. The option with two beam delivery systems continues to be investigated. Push-pull is being engineered to proceed efficiently, allowing for quick vacuum and cryogenic disconnects, signal and power umbilicals, and the means to reestablish alignment and calibration quickly. The two detectors provide redundancy, cross-checks and insurance against mishaps.

Precise knowledge of the beam energy and polarization is critical to the physics program, and they can be measured both upstream and downstream of the detector, using energy spectrometers and polarimeters.

CHAPTER 4

Value Estimates

4.1 THE ACCELERATOR

A preliminary cost analysis has been performed for the ILC Reference Design. A primary goal of the estimate was to allow cost-to-performance optimization in the Reference Design, before entering into the engineering design phase. Over the past year, the component costs were estimated, various options compared and the design evolved through about ten significant cost-driven changes, resulting in a cost reduction of about 25%, while still maintaining the physics performance goals.

The ILC cost estimates have been performed using a “value” costing system, which provides basic agreed-to value costs for components in ILC Units¹, and an estimate of the explicit labor (in person hours) that is required to support the project. The estimates are based on making world-wide tenders (major industrialized nations), using the lowest reasonable price for the required quality. There are three classes of costs:

- site-specific costs, where a separate estimate was made in each of the three regions;
- conventional costs for items where there is global capability – here a single cost was determined;
- costs for specialized high-tech components (e.g. the SCRF linac technology), where industrial studies and engineering estimates were used.

The total estimated value for the shared ILC costs for the Reference Design is 4.79 Billion (ILC Units). An important outcome of the value costing has been to provide a sound basis for determining the relative value of the various components or work packages. This will enable equitable division of the commitments of the world-wide collaboration.

In addition, the site specific costs, which are related to the direct costs to provide the infrastructure required to site the machine, are estimated to be 1.83 Billion (ILC Units). These costs include the underground civil facilities, water and electricity distribution and buildings directly supporting ILC operations and construction on the surface. The costs were determined to be almost identical for the Americas, Asian, and European sample sites. It should be noted that the actual site-specific costs will depend on where the machine is constructed, and the facilities that already exist at that location.

¹For this value estimate, 1 ILC Unit = 1 US 2007\$ (= 0.83 Euro = 117 Yen).

Finally, the explicit labor required to support the construction project is estimated at 24 million person-hours; this includes administration and project management, installation and testing. This labor may be provided in different ways, with some being contracted and some coming from existing labor in collaborating institutions.

The ILC Reference Design cost estimates and the tools that have been developed will play a crucial role in the engineering design effort, both in terms of studying options for reducing costs or improving performance, and in guiding value engineering studies, as well as supporting the continued development of a prioritized R&D program.

The total estimated value cost for the ILC, defined by the Reference Design, including shared value costs, site specific costs and explicit labor, is comparable to other recent major international projects, e.g. ITER, and the CERN LHC when the cost of pre-existing facilities are taken into account. The GDE is confident that the overall scale of the project has been reliably estimated and that cost growth can be contained in the engineering phase, leading to a final project cost consistent with that determined at this early stage in the design.

4.2 THE DETECTORS

Three detector concepts, GLD, LDC, and SiD, estimated the costs of their respective detector designs. Each used a complete work breakdown structure, and identified the significant costs associated with subsystems, and costs associated with assembly and installation. Estimates were guided by the GDE costing rules, and included approximately 35% contingency. The three estimates are reasonably consistent, but are divided differently between M&S and labor, a result of regional accounting differences.

The cost drivers for the M&S budgets are the calorimeters and the solenoidal magnet and flux return iron. Integration, transportation, and computing have been included, as have indirect costs associated with both M&S and labor.

The coil costs for each of the concepts were consistent with the costs for the BaBar, Aleph, and CMS coils when compared as a function of stored energy. The cost breakdowns across detector subsystems for each of three concepts differ concept to concept. This is to be expected, as SiD has costed electronics, installation, and management as separate items whereas LDC and GLD have embedded these in the subdetectors. In another example, GLD chooses to cost both hadron and electromagnetic calorimeters as a single item, since the detectors used are similar. LDC and SiD have separated these expenses, because the detection techniques are quite different.

Based on the SiD and LDC estimates, the value (M&S) cost is in the range 360-420 Million (ILC Units) each. GLD does not estimate M&S separately. Manpower for SiD and LDC (including contingency) is estimated at 1250-1550 person-years. Combining M&S and person-years, the total detector cost lies in the range of 460-560 Million (ILC Units) for any of the detector concepts. The cost scale for the two detectors envisioned for the ILC is about 10% of the cost of the machine.

CHAPTER 5

Next Steps: R&D and the Engineering Design Phase

5.1 ACCELERATOR R&D

For the last year, the focus of the core GDE activity has been on producing the RDR and value estimate. In parallel, ILC R&D programs around the world have been ramping up to face the considerable challenges ahead. The GDE Global R&D Board – a group of twelve GDE members from the three regions – has evaluated existing programs, and has convened task forces of relevant experts to produce an internationally agreed-upon prioritized R&D plan for the critical items. The highest-priority task force (S0/S1) addresses the SCRF accelerating gradient:

- S0: high-gradient cavity – aiming to achieve 35 MV/m nine-cell cavity performance with an 80% production yield;
- S1: high-gradient cryomodule – the development of one or more high-gradient ILC cryomodules with an average operational gradient of 31.5 MV/m.

The S0/S1 task force has already produced focused and comprehensive R&D plans. Other task forces (S2: test linac; S3: Damping Ring; S4: Beam Delivery System, etc.) are in the process of either completing their reports, or just beginning their work.

For the cost- and performance-critical SCRF, the primary focus of S0/S1 remains the baseline choice, the relatively mature TESLA nine-cell elliptical cavity. However, additional research into alternative cavity shapes and materials continues in parallel. One promising technique is the use of ‘large-grain’ niobium [27], as opposed to the small-grain material that has been used in the past (Figure 5.1). Use of large grain material may remove the need for electropolishing, since the same surface finish can potentially be achieved with Buffered Chemical Polishing (BCP) – a possible cost saving. Several single-cells have achieved gradients in excess of 35 MV/m (without electropolishing) and more recent nine-cell cavity tests have shown very promising results.

Various new and promising cavity shapes are also being investigated, primarily at KEK and Cornell. While the basic nine-cell form remains, the exact shape of the ‘cells’ is modified to reduce the peak magnetic field at the niobium surface. In principle these new shapes can achieve higher gradients, or higher quality factors (Q_0). Single-cells at KEK (ICHIRO) and Cornell (reentrant) have achieved the highest gradients to date (~ 50 MV/m, see Figure 5.1).

NEXT STEPS: R&D AND THE ENGINEERING DESIGN PHASE

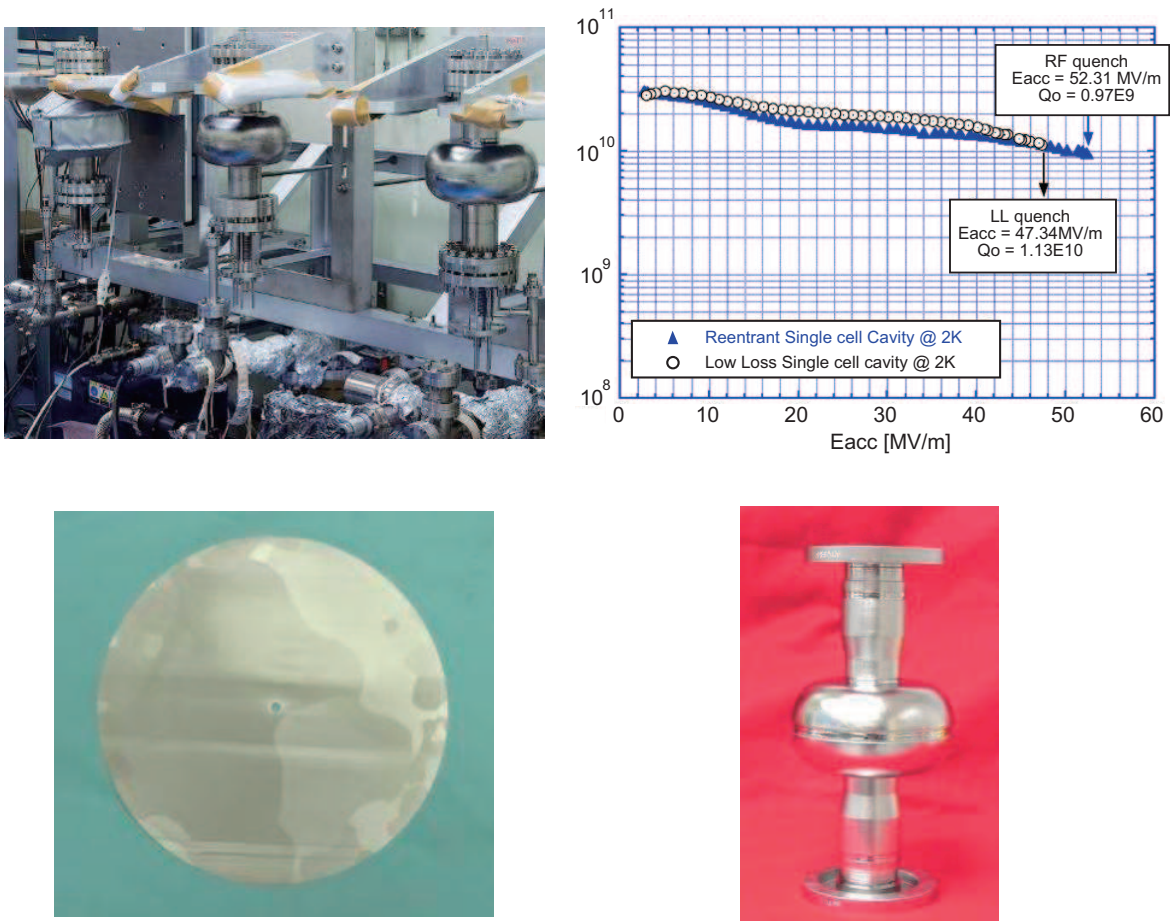

FIGURE 5.1. Cutting-edge SCRF R&D. Top-left: ICHIRO single-cells being prepared for testing at KEK. Top-right: world-record performance from novel shape single-cells (ICHIRO and Cornell's reentrant cavity). Bottom-left: large-grain niobium disk (Jefferson Lab). Bottom-right: single-cell cavity produced from large-grain niobium material (Jefferson Lab).

R&D towards making high-performance nine-cell cavities using these designs continues as future possible alternatives to the ILC baseline cavity.

The GDE formally supports R&D on alternative designs for components other than the cavities, where the new designs promise potential cost and/or performance benefits. Some key examples are alternative RF power source components, of which the Marx modulator is currently the most promising. In addition, R&D on critical technologies will continue through the EDR. Topics include items such as the damping ring kickers and electron-cloud mitigation techniques, the positron target and undulator, the magnets around the beam interaction point, and global issues that require very high availability such as the control system, the low-level RF, and the magnet power supplies.

5.2 THE DETECTOR ROADMAP: R&D AND ENGINEERING DESIGNS

The detector R&D and integrated detector design efforts must keep pace with progress on the ILC. The detector R&D program, which has already developed over many years, includes efforts in all regions, with inter-regional collaboration in some cases, and inter-regional coordination in all cases. The R&D is reviewed within the global context by the World Wide Study. This R&D is critical to the success of the ILC experimental program.

To focus integrated detector design efforts over the next few years, the current studies for four distinct concepts will be concentrated into two engineering design efforts, in time for the submission of two detector EDRs at the same time as the ILC machine EDR. The ILCSC will issue a call for Letters of Intent to the ILC detector community during Summer 2007 to initiate this process. The next steps are still being developed by the ILCSC, but will include appointing a Research Director, who will be responsible for developing the ILC experimental program, and establishing an International Detector Advisory Group, which will help define the two experiments suitable for engineering design. The resulting two detectors are expected to have complementary and contrasting strengths, as well as broad international participation. The two detector concepts should be defined by early 2009, and their engineering designs will then be completed over the next two or three years.

5.3 TOWARDS THE ENGINEERING DESIGN REPORT (EDR)

While investment into the critical R&D remains a priority, a significant ramping-up of global engineering resources will now be required to produce an engineered technical design by 2010. An important aspect of this work will be the refinement and control of the published cost estimate by value engineering. The EDR phase will also require a restructuring of the GDE to support the expanded scope. A more traditional project structure will be adopted based on the definition of a discrete set of Work Packages. The responsibility for achieving the milestones and deliverables of each Work Package will be assigned to either a single institute, or consortium of institutes, under the overall coordination of a central project management team. The Work Packages need to be carefully constructed to accommodate the direct needs of the Engineering Design phase, while at the same time reflecting the global nature of the project. An important goal of the current planning is to integrate the engineering design and fundamental R&D efforts, since these two aspects of the project are clearly not independent. The new project structure will be in place by mid 2007.

The GDE remains committed to the technically-driven schedule of supplying the EDR in 2010, making start of construction possible as early as 2012 consistent with expected early results from the LHC. The critical path and cost drivers have been clearly identified during the RDR phase, and they define the priorities for the next three years of the Engineering Design phase. The R&D program will be fine-tuned to mitigate the remaining identified technical risks of the design. A key element of the engineering activity will be the formation of a qualified industrial base in each region for the SCRF linac technology. A equally critical focus will be on the civil construction and conventional facilities the second primary cost driver where an early site selection would clearly be advantageous.

Finally, the GDE also remains committed to completing these challenging goals as a truly international organization, by building on and consolidating the successful collaboration

NEXT STEPS: R&D AND THE ENGINEERING DESIGN PHASE

which produced the RDR. The support of the world-wide funding agencies is critical in this endeavor. The GDE together with the leaders of the particle physics community will continue to work with the regional funding agencies and governments to begin construction of this project in the early part of the next decade.

BIBLIOGRAPHY

- [1] A. Albrecht, *et al.*, Report of the DOE/NSF High Energy Physics Advisory Panel (2004).
- [2] H. Shapiro *et al.*, “Report of the Committee on Elementary Particle Physics in the 21st Century,” Board of Physics and Astronomy, National Research Council, National Academies Press, Washington D.C. (2006); “The European Strategy for Particle Physics,” Report of CERN Council Strategy Group (2006); GLC Project: “Linear Collider for TeV Physics” ,KEK-REPORT-2003-7; I. Corbett *et al.*, “Report of the Consultative Group on High-Energy Physics,” OECD Global Science Forum (2002); S. Yamada *et al.*, “Report of the JLC Globalization Committee” (2002); Aguilar-Saavedra, J. A. *et al.*, “TESLA Technical Design Report Part III: Physics at an e+e- Linear Collider,” hep-ph/0106315; ACFA Linear Collider Working Group, “Particle Physics Experiments at JLC,” hep-ph/0109166; Abe, T. and *et al.*, “Linear Collider Physics Resource Book for Snowmass,” American Linear Collider Working Group (2001).
- [3] J. Bagger *et al.*, “Discovering the Quantum Universe: The Role of Particle Colliders,” Report of the DOE/NSF High Energy Physics Advisory Panel (2006).
- [4] ATLAS Collaboration, “ATLAS Physics Technical Design Report,” CERN-LHCC-99-14 and CERN-LHCC-99-15, <http://atlas.web.cern.ch/Atlas/GROUPS/PHYSICS/TDR/TDR.html>; “CMS Physics TDR,” CERN/LHCC/2006-021 (2006).
- [5] R. Cousins, J. Mumford and V. Valuev, “Forward-Backward Asymmetry of Simulated and Reconstructed Z-prime $\rightarrow \mu^+\mu^-$ Events in CMS” CERN-CMS-NOTE-2005-022 (2005)
- [6] “Parameters for the Linear Collider,” http://www.fnal.gov/directorate/icfa/LC_parameters.pdf (2003) and <http://www.fnal.gov/directorate/icfa/para-Nov20-final.pdf> (2006).
- [7] G. Moortgat-Pick *et al.*, “The Role of Polarized Positrons and Electrons in Revealing Fundamental Interactions at the Linear Collider,” hep-ph/0507011 (2005).
- [8] R. Hawkings and K. Moenig, “Electroweak and CP violation physics at a Linear Collider Z-factory,” hep-ex/9910022 (1999).
- [9] C. A. Heusch, “The International Linear Collider in its Electron-Electron Version,” Int. J. Mod. Phys.A20 (2005).
- [10] I. F. Ginzburg, G. L. Kotkin, V. G. Serbo and V. I. Telnov, JETP Lett. 34 (1981) 491; Badelek, B. *et al.*, hep-ex/0108012.

BIBLIOGRAPHY

- [11] ITRP Recommendation, http://www.fnal.gov/directorate/icfa/ITRP_Report_Final.pdf (2004).
- [12] R. Brinkmann *et al.*, eds., “TESLA Technical Design Report,” DESY-2001-011 (March, 2001).
- [13] T. O. Raubenheimer *et al.*, eds., “Zeroth Order Design Report for the Next Linear Collider,” SLAC-R-474 (1996); N. Phinney, ed., “2001 Report on the Next Linear Collider: A report submitted to Snowmass ’01,” SLAC-R-571 (2001).
- [14] “GLC project: Linear Collider for TeV Physics,” KEK-Report-2003-7, <http://lcdev.kek.jp/Roadmap/> (2003)
- [15] M. Altarelli *et al.*, “The European X-Ray Free-Electron Laser Technical Design Report,” DESY 2006-097 (2006).
- [16] F. Furuta *et al.*, “Experimental Comparison at KEK of High Gradient Performance of Different Single-Cell Superconducting Cavity Designs,” EPAC06 (2006); R. L. Geng *et al.*, “High-Gradient Activities at Cornell: Re-entrant Cavities,” SRF 2005 (2005).
- [17] K. Abe *et al.*, “Particle Physics Experiments at JLC,” KEK-Report-2001-11 and hep-ph/0109166 (2001); T. Abe *et al.*, “Linear Collider Physics Resource Book for Snowmass 2001,” BNL-52627, CLNS01/1279, FERMILAB-Pub-01/058-E, LBNL-47813, SLAC-R-570, UCRL-ID-143810-DR (2001).
- [18] The SiD Concept Group, “SiD Detector Outline Document, <http://physics.uoregon.edu/~lc/wwstudy/concepts/> (2006).
- [19] The LDC Concept Group, “LDC Detector Outline Document,” <http://www.ilcldc.org> (2006).
- [20] GLD Concept Study Group, “GLD Detector Outline Document,” physics/0607154 (2006).
- [21] The 4th Concept Group, “Detector Outline Document,” <http://physics.uoregon.edu/~lc/wwstudy/concepts/> (2006).
- [22] H. J. Schreiber, “Branching fraction measurements of the SM higgs with a mass of 160 GeV at future linear colliders,” LC-PHSM-2000-035 (2000); T. Barklow, “Physics impact of detector performance,” 2005 ILC Workshop, <http://www-conf.slac.stanford.edu/lcws05/program/talks/18mar2005.ppt> (2005); H.-J. Yang and K. Riles, “Impact of tracker design on higgs and slepton measurements,” physics/0506198 (2005).
- [23] T. Abe, “A Study of Topological Vertexing for Heavy Quark Tagging” , SLAC-PUB-8775 (2001).
- [24] N. Akchurin *et al.*, NIM **A537**, 537-561 (2005).
- [25] F. Gaede *et al.*, <http://ilcsoft.desy.de/marlin>; T. Johnson *et al.*, “lcorg.sim: A Java-based Reconstruction and Analysis Toolkit,” <http://www.lcsim.org>; C. Gatto *et al.*, <http://www.fisica.unile.it/~danieleb/IlcRoot>.

- [26] M. Thomson, Paris ILC Software Meeting (2007).
- [27] P. Kneisel *et al.*, “Preliminary Results from Single Crystal and Very Large Crystal Niobium Cavities,” PAC05 (2005).

BIBLIOGRAPHY

LIST of FIGURES

| | | |
|------|---|----|
| 1.1 | The electromagnetic and weak nuclear forces unify at the Terascale. | 2 |
| 1.2 | Relic density and mass determinations for neutralino dark matter. | 3 |
| 2.1 | A TESLA nine-cell 1.3 GHz superconducting niobium cavity. | 8 |
| 2.2 | SCRF Cryomodules. | 9 |
| 2.3 | High-performance nine-cell cavities. | 9 |
| 2.4 | Clean room environments are mandatory. | 10 |
| 2.5 | Birth of a nine-cell cavity. | 10 |
| 2.6 | Schematic layout of the ILC complex for 500 GeV CM. | 12 |
| 2.7 | Schematic View of the Polarized Electron Source. | 14 |
| 2.8 | Overall Layout of the Positron Source. | 15 |
| 2.9 | Schematic of the RTML. | 17 |
| 2.10 | RF unit layout. | 19 |
| 2.11 | Cutaway view of the linac dual-tunnel configuration. | 20 |
| 2.12 | BDS layout, beam and service tunnels. | 21 |
| 2.13 | Geology and tunnel profiles for the three regional sites. | 23 |
| 3.1 | Higgs recoil mass spectra | 27 |
| 3.2 | Illustration of a quadrant of SiD. | 29 |
| 3.3 | View of the LDC detector concept | 30 |
| 3.4 | Schematic view of two different quadrants of the GLD Detector. | 31 |
| 3.5 | Cut-away view of the 4th Detector | 32 |
| 3.6 | RMS90 as a function of $ \cos \theta_q $ | 33 |
| 3.7 | The jet energy resolution | 33 |
| 5.1 | Cutting-edge SCRF R&D. | 38 |

LIST OF FIGURES

LIST of TABLES

| | | |
|-----|--|----|
| 2.1 | Basic design parameters for the ILC. | 13 |
| 2.2 | Nominal and design range of beam parameters at the IP. | 13 |
| 3.1 | Some key parameters of the four detector concepts. | 28 |
| 3.2 | Jet energy resolutions based on simulations of LDC. | 32 |