

## PERFORMANCE OF THE FONT3 FAST ANALOGUE INTRA-TRAIN BEAM-BASED FEEDBACK SYSTEM AT ATF

P.N. Burrows, G. Christian, C. Clarke, H. Dabiri Khah, T. Hartin, C. Perry, G.R. White, John Adams Institute, Oxford University, UK; A. Kalinin, Daresbury Laboratory, UK; D. McCormick, S. Molloy, M. Ross, SLAC, USA.

### Abstract

We report results of beam tests of the FONT3 intra-train position feedback system prototype at the Accelerator Test Facility (ATF) at KEK. The feedback system incorporates a novel beam position monitor (BPM) processor with latency below 5 nanoseconds, and a kicker driver amplifier with similar low latency. The 56 nanosecond-long bunchtrain in the ATF extraction line was used to test the prototype feedback system. The achieved latency of 23ns provides a demonstration of intra-train feedback on very short timescales relevant even for the CLIC Linear Collider design.

### INTRODUCTION

A number of fast beam-based feedback systems are required at the International electron-positron Linear Collider (ILC) [1]. At the interaction point (IP) a very fast system, operating on nanosecond timescales within each bunchtrain, is required to compensate for residual vibration-induced jitter on the final-focus magnets by steering the electron and positron beams into collision. A pulse-to-pulse feedback system is envisaged for optimising the luminosity on timescales corresponding to 5 Hz. Slower feedbacks, operating in the 0.1 – 1 Hz range, will control the beam orbit through the Linacs and Beam Delivery System.

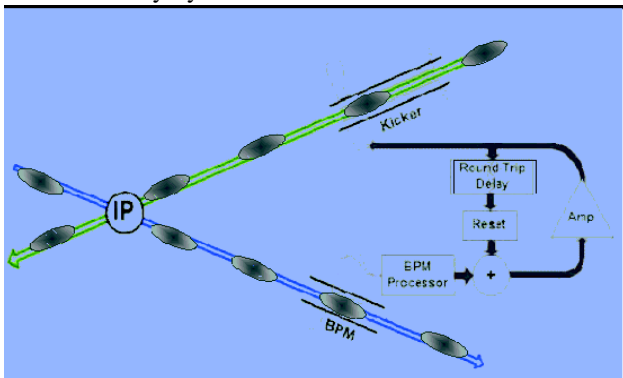

Figure 1: Schematic of IP intra-train feedback system for an interaction region with a crossing angle. The deflection of the outgoing beam is registered in a BPM and a correcting kick applied to the incoming other beam.

The key components of each such system are beam position monitors (BPMs) for registering the beam orbit; fast signal processors to translate the raw BPM pickoff signals into a normalised position output; feedback circuits, including delay loops, for applying gain and taking account of system latency; amplifiers to provide the required output drive signals; and kickers for applying the position (or angle) correction to the beam. A schematic of the IP intra-train feedback is shown in Figure 1, for the case in which the electron and positron beams cross with a small angle.

A critical issue for the intra-train feedback performance is the latency of the system, as this affects the number of corrections that can be made within the duration of the bunchtrain. Here we report on an all-analogue feedback design that is optimised for short latency. Originally conceived for the ‘warm’ design of the Linear Collider [2] with a bunchtrain length of c.270ns, the system is also directly applicable at CLIC [3] where the current design incorporates a very short bunchtrain of length less than 100ns.

### FONT 3

Feedback On Nanosecond Timescales (FONT) is a collaboration between UK academic groups (Oxford, Daresbury) and the ILC Group at SLAC with the purpose of prototyping and testing IP feedback components. Two rounds of earlier tests have taken place (FONT1, FONT2) with the 65 MeV electron beam at the NLC Test Accelerator (NLCTA) at SLAC [4,5]. At NLCTA the train length was c. 170ns, and an intra-train feedback system was demonstrated with a latency of 54ns and a correction ratio of 14/1.

Here we report on beam tests of the FONT3 prototype, which we operated at the Accelerator Test Facility extraction line at KEK. The bunchtrain comprised 20 electron bunches separated by 2.8ns with a beam energy of c. 1.3 GeV. The total train length of 56ns presents a severe challenge for an intra-train feedback system. Hence we designed FONT3 as a fast-analogue system with a goal of 20ns total latency, which includes the beam time-of-flight and signal propagation delays (Table 1).

Source of delay	Contribution to latency (ns)
Beam time-of-flight	4
Signal return time	6
BPM processor	5
Amplifier risetime	5
<b>Total</b>	<b>20</b>

Table 1: Design parameters for the FONT3 system.

A schematic of the experimental configuration in the ATF extraction beamline is shown in Figure 2. The layout is functionally equivalent to the ILC intra-train feedback system. An upstream dipole corrector magnet can be used to steer the beam so as to introduce a controllable vertical position offset in stripline BPM ML11X. A signal processor and a feedback circuit provide a correction signal to drive the adjustable-gap stripline kicker [6] so as to steer the beam back into nominal vertical position. BPMs ML12X and ML13X serve as independent witnesses of the beam position. The experimental setup is illustrated in Figures 3 and 4.

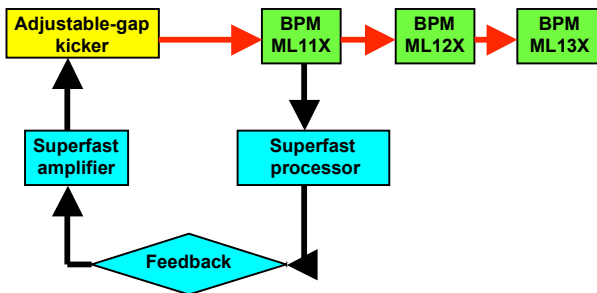

Figure 2: Schematic of the ATF extraction beamline showing the relative locations of the kicker, BPMs and feedback system.

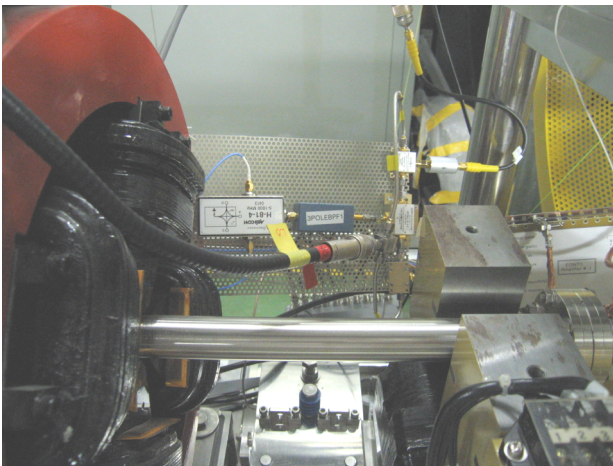

Figure 3: Downstream section of the ATF beamline showing the BPM signal processor.

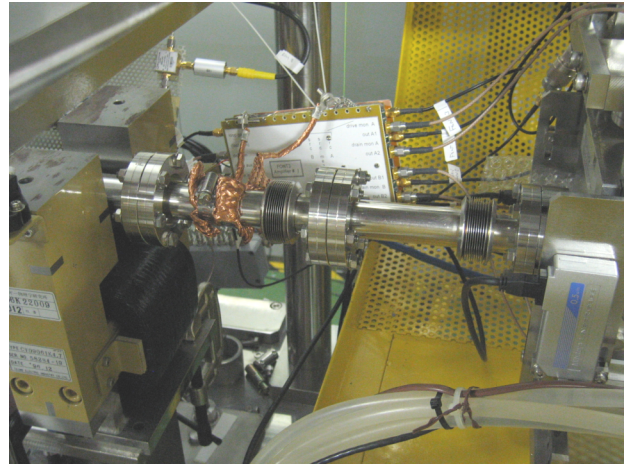

Figure 4: Upstream section of the ATF beamline showing the integrated amplifier and feedback board.

## SIGNAL PROCESSOR

The design of the BPM signal processor [7] is illustrated in Figure 5. The top and bottom stripline signals were subtracted using a hybrid. The resulting difference signal was band-pass filtered and down-mixed with a 714 MHz local oscillator signal which was phase-locked to the beam. The resulting baseband signal is low-pass filtered. The hybrid, filters and mixer were selected to have latencies of order 1ns, in an attempt to yield a total processor latency of less than 5ns. The performance of the signal processor was reported previously [8]; a latency of c. 4.3ns was achieved with a position resolution of 3 $\mu$ m.

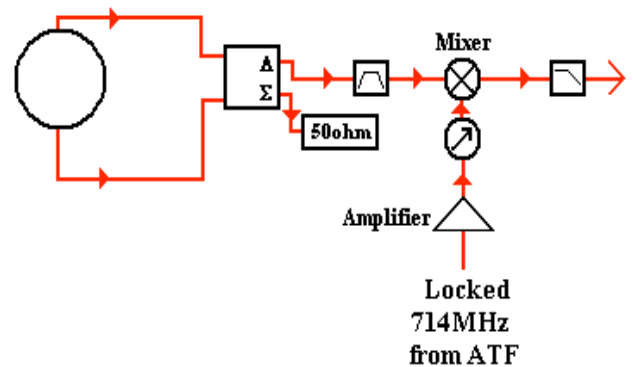

Figure 5: Schematic of BPM signal processor.

## BEAM FEEDBACK TESTS

A 200W-level solid-state amplifier, and fast-analogue feedback circuit using the BPM processor output as its input, were fabricated for closed-loop feedback tests in the ATF beamline in June 2005. The amplifier latency was designed to match that of the BPM processor, yielding c. 10ns total electronics latency. The beam flight time between the kicker and the BPM was c. 4ns, and the return signal path propagation time was c. 6ns (Table 1).

With such a total latency of c. 20ns it was aimed to demonstrate closed-loop feedback, with delay-loop action, within the bunchtrain length of 56ns. The amplifier power and BPM resolution are similar to those required for the IP feedback system at the ILC.

The performance of the FONT3 system is summarised in Figure 6. The beam was steered in turn to one of five vertical positions, corresponding to a range of 200um in vertical offset at BPM ML11X (Figure 6 top). For each position setting, the feedback was activated. In the first instance the delay-loop function was not enabled (Figure 6 middle). After the first latency period the beam position was corrected, and after the second period the beam started to return to its original offset. In the second instance the delay loop was enabled (Figure 6 bottom). In this case the system attempted to preserve the correction for the duration of the bunchtrain.

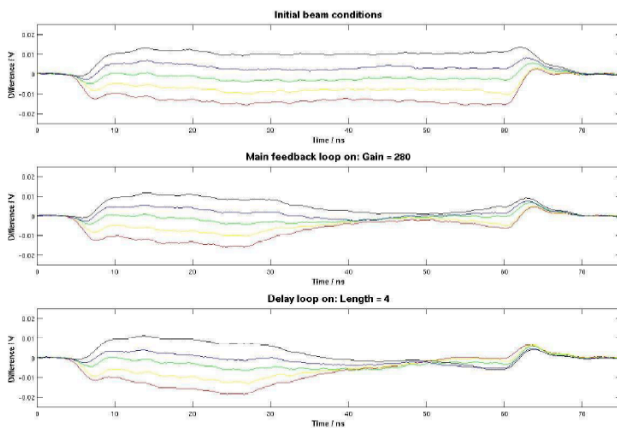

Figure 6: Average beam position (arbitrary units) vs. time in nanoseconds. The bunchtrain starts at c. 6ns and ends at c. 62ns. Each trace is the average of the respective 40 sequential beam pulses shown in Figure 7.

It can be seen that, for each initial position setting, the beam was steered towards nominal zero position offset. From these results the latency of the system was measured to be c. 23ns [7]. From Figure 6 it is apparent that the main loop gain, and delay-loop gain, were not fully optimised, as there is still variance in the corrected beam position: the main loop appears to over-correct, and the delay loop to under-correct. Attempts to optimise these gains were hampered by poor and variable beam conditions, including intra-train beam jitter and train-to-train jitter of similar order to the difference in initial beam offset settings. This situation is illustrated in Figure 7

## SUMMARY AND OUTLOOK

The ultra-low latency of the FONT3 system was designed to match the bunch spacing (c. 1ns) and train length (100-300ns) of the 'warm' Linear Collider designs. The

achieved latency of 23ns represents a proof of principle even for CLIC. In August 2004 superconducting Nb linac technology was selected for the ILC. In this design the bunch spacing is 337ns and the total train length is c. 1ms. Although the FONT3 analogue technology could be deployed at ILC, the longer bunch interval and large number of bunches allow for a digital approach to signal processing, and hence the implementation of more sophisticated feedback algorithms. We are now pursuing the design of such a prototype digital feedback system, FONT4, for ILC [9].

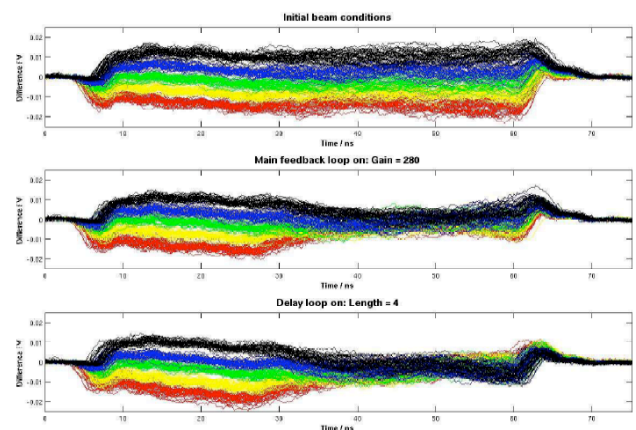

Figure 7: Beam position (arbitrary units) vs. time in nanoseconds. The bunchtrain starts at c. 6ns and ends at c. 62ns. 40 sequential beam pulses per position setting are shown.

**This work is supported by the Commission of the European Communities under the 6th Framework Programme "Structuring the European Research Area", contract number RIDS-011899, and by the UK Particle Physics & Astronomy Research Council.**

## REFERENCES

- [1] ILC: <http://www.linearcollider.org/cms/>
- [2] NLC: <http://www-project.slac.stanford.edu/nlc/>  
GLC: <http://acfahep.kek.jp>
- [3] CLIC: <http://clic-study.web.cern.ch/CLIC-Study/>
- [4] FONT1: P.N. Burrows et al, Proceedings PAC03, Portland, Oregon, May 2003, p. 687.
- [5] FONT2: P.N. Burrows et al, Proceedings EPAC04, Lucerne, July 2004, p. 785.
- [6] FEATHER:  
<http://acfahep.kek.jp/subg/ir/feather/index.html>
- [7] S. Molloy, Ph.D. thesis, University of London, February 2006.
- [8] P.N. Burrows et al, Proceedings PAC05, Knoxville, TN, May 2005, p. 1359.
- [9] FONT4: P.N. Burrows et al, these proceedings.