

THE FAST SHAVING EJECTION FOR
BEAM TRANSFER FROM THE CPS TO THE CERN 300 GeV MACHINE

C. Bovet, D. Fiander, L. Henny, A. Krusche, G. Plass
CERN, Geneva, Switzerland

Summary

A fast shaving ejection during 10 or 11 turns is the most promising system for the transfer of the CPS beam to the 300 GeV machine under construction for which the CPS is to be the injector. The scheme uses a pair of fast kickers which shift the beam in 10 or 11 steps across an electrostatic septum, located at a position where the amplitude function is increased to near 100m and the momentum compaction function reduced to near zero. A prototype system has been installed in the CPS and tests have been carried out at 10 GeV/c with bunched and adiabatically debunched beams. The stability of the operation, ejection efficiency, emittance and momentum spread of the ejected beam are of major interest and have been measured. The test results are in agreement with theory and no serious difficulties have been observed.

Introduction

The extraction of a proton beam during a few tens of revolutions was already proposed in 1966¹⁾ but detailed studies started later when the CERN PS became of interest as an injector for the future 300 GeV machine²⁾. The multiturn shaving ejection ("continuous transfer system") allows a uniform filling of the SPS circumference which is of special interest to avoid longitudinal instabilities. Furthermore, this scheme copes with a bunched or debunched beam, so that debunching in the SPS can be avoided, thus resulting in a smaller longitudinal bunch area.

Another advantage of the system is the reduction of the horizontal beam emittance to about one third of that of the CPS. Firstly, a numerical analysis³⁾ established the feasibility of the scheme, then tests were performed on the machine. Results of both will be reported hereafter.

paction factor α_p nearly zero (see Fig. 2). The local blow-up helps to reduce beam losses on the ES, and $\alpha_p \approx 0$ reduces the momentum shift during the peeling process to a negligible value. The pair of quadrupoles is matched such that the phase advance between the fast bumpers is exactly $3\pi/2$ (see Fig. 1), and the relative strength of the fast bumpers is adjusted to avoid coherent oscillations.

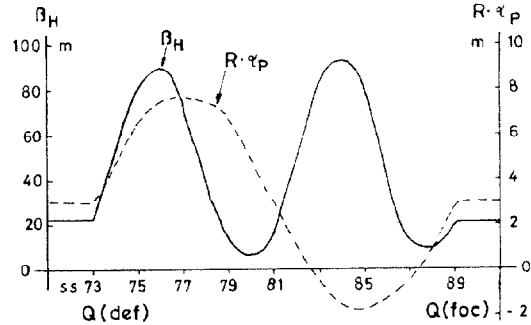

FIG. 2: β_H AND MOMENTUM COMPACTION BETWEEN EJECTION QUADRUPOLES

Hardware Description

The slow bumpers, quadrupoles and the extractor magnet are standard devices and will not be described here. The electrostatic septum (ES) is normally used for slow ejection⁵⁾, the working conditions are listed below. The fast bumpers FB71 and FB95 and the associated programmed pulse generator were designed specially for these tests^{6,7)}. Its block diagram is shown in Fig. 3. It consists of 22 thyratrons, 11 of which are connected in series via cables acting as storage lines. The discharge length of each cable is slightly longer than the revolution time of the particles in the CPS (2.1 μ s) in order to

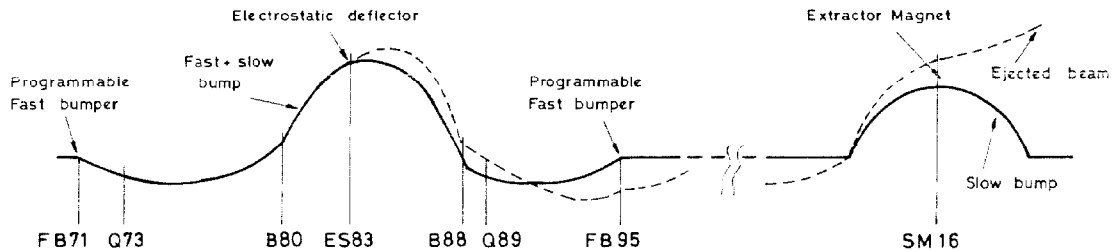

FIG. 1: SCHEME OF SHAVING EJECTION

Test Arrangement

The test arrangement has been worked out so that as many elements as possible of existing ejection schemes could be used⁴⁾. Fig. 1 shows the location of the hardware in the CPS ring together with the schematic orbits. The slow bumpers B80 and B88 push the beam onto the electrostatic septum ES83, across which the beam is shifted progressively by means of the programmed fast bumpers FB71 and FB95. Two quadrupoles Q73 and Q89 are added in order to achieve a beam blow up at the ES position and at the same time to make the momentum com-

avoid holes in the programme pulse. The lines are charged by 11 resonant power supplies allowing an individual voltage adjustment of every step of the programme pulse. Fig. 4c shows a typical magnet current pulse used during the tests.

Specifications:

- Fast bumpers FB71 + 95:
- max. bending angle: 0.75mrad at 10 GeV/c,
- inductance: 9.6 μ H,
- rise and fall time: \sim 450ns.

Generator:

- 11 programmable steps;
- max. current 850A;
- step pulse length 2.1 μ s;
- impedance 25 Ω ;
- max. voltage ~ 45 kV.

Electrostatic septum:

- septum thickness 0.1mm;
- length 0.8m;
- field strength 120 kV over 10mm gap;

Quadrupoles:

- $|K| = 0.07\text{m}^{-1}$.

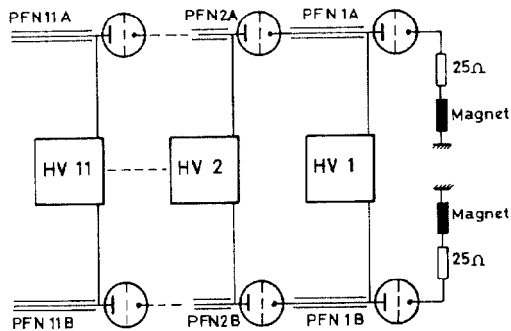

FIG. 3: BLOCK DIAGRAM OF THE STAIRCASE PULSE GENERATOR

Instrumentation

Besides the standard CPS equipment for beam observation, specialized fast beam transformers were used for the circulating and the ejected beam. The droop of the transformer was compensated electronically. The RF bunch structure of the signal was filtered out in order to be independent of the bunch form. This technique allows to observe the signal contour comfortably on a storage scope. Moreover, an analog divider unit controlled by the internal beam intensity permitted a display of normalized signal height.

Test Results

General. All the tests were carried out at 10 GeV/c but under various machine conditions: during normal acceleration, on a magnetic flat top, with high or reduced RF voltage, after adiabatic debunching. Several horizontal betatron oscillation frequencies were tried out ($6.23 \leq Q_H \leq 6.28$) as well as several betatron amplitudes at the ES position. Various tuning of the quadrupole pair and compensation of the pair of fast bumpers were applied in order to modify the residual coherent oscillations. It is easier to compensate for them when $Q_H \approx 6.28$, but in fact they have little importance because their effect on the ejected beam can always be cancelled by appropriate adjustment of the fast bumper programme. Whatever the set of conditions chosen, it was always possible to eject the beam without difficulties. The machine intensity during the tests was between 120 and $180 \cdot 10^{10}$ ppp.

The standard operation was an 11 turn ejection, but after readjustment of the staircase pulse of the fast bumpers, ejection within 10 or fewer turns was easily possible.

Figs. 4a,b,c show the internal beam current decreasing during 23 μ s in 11 steps together with the ejected beam signal and the related staircase pulse of the fast bumpers.

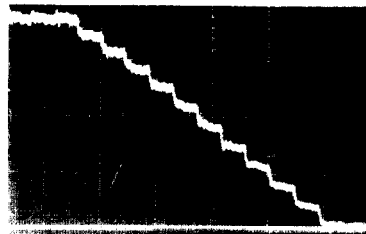

FIG. 4 a)
FALLING INTENSITY OF
CPS BEAM OVER 11 TURNS
(5 μ s/cm; RF STRUCTURE
FILTERED OUT)

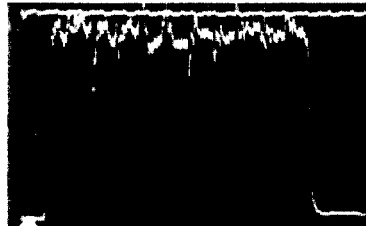

FIG. 4 b)
TYPICAL EJECTED BEAM
INTENSITY
(5 μ s/cm; RF STRUCTURE
FILTERED OUT)

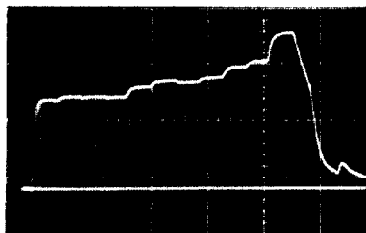

FIG. 4 c)
TYPICAL CURRENT OF FAST
BUMPERS
(5 μ s/cm)

The rise and fall time of the ejected beam are determined by the properties of the fast bumpers and are here of the order of 450ns (10 to 90% of amplitude).

Efficiency of 11 Turn Shaving Ejection

The efficiency of the operation is rather important, not so much from the beam transfer point of view, but rather concerning the induced radioactivity in the CPS.

The computer simulation gave approx. 8% loss under the following assumptions: apparent thickness of the electrostatic septum $d = 0.15\text{mm}$, horizontal emittance $\epsilon = 1.3\mu\text{rad}\cdot\text{m}$, $\beta = 90\text{m}$ at ES, all particles hitting the septum being lost.

The efficiency was measured by comparison with a fast extracted beam (the 20 bunch fast extraction is virtually lossless) and by calibration of a loss monitor near the ES. The horizontal emittance was measured at the same time. The measured efficiencies were 90% and 91% respectively with an emittance of $1\mu\text{rad}\cdot\text{m}$.

The efficiency is expected to increase with higher intensity in the CPS because of the conjoint increase of emittance (the computed efficiency is over 96% for $\epsilon = 6\mu\text{rad}\cdot\text{m}$).

Profile Measurements

The peeling process implies an emittance reduction of the ejected beam which changes with time. An emittance measurement is difficult because of the complicated shapes of the beam cuts and the influence of the momentum spread. In order to check the predictions, the beam profile was measured in locations where it shows significant changes from turn to turn.

Figs. 5a,b, show the computed beam profiles of the ejected beam in these locations and Figs. 6a,b, show examples of measurements made with a charge collecting scanning target whose analog signals were sampled as a function of time and horizontal displacement. The curves are in qualitative agreement.

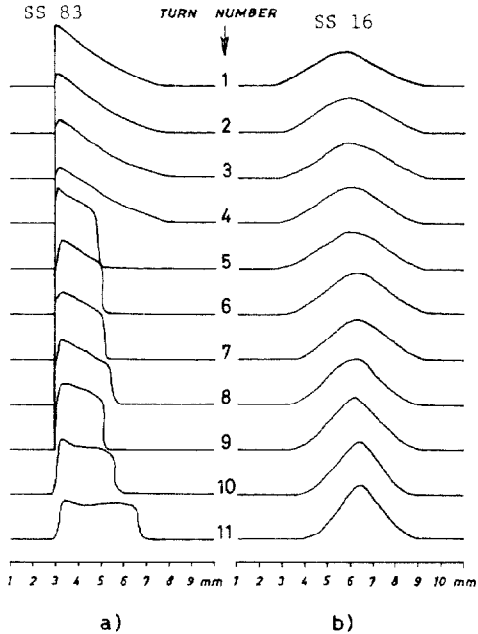

FIG. 5: COMPUTED PROFILE OF EJECTED BEAM
 $Q_H = 6.250$; TOTAL MOMENTUM SPREAD $1.2 \cdot 10^{-3}$

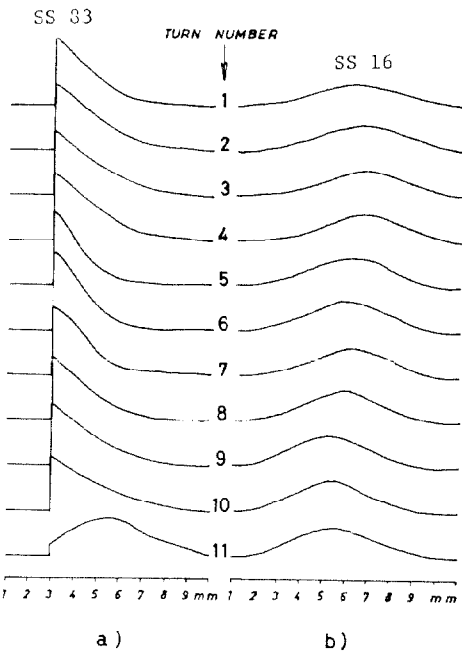

FIG. 6: EXPERIMENTAL PROFILE EVOLUTION OF EJECTED BEAM
 $Q_H = 6.246$; TOTAL MOMENTUM SPREAD $1.2 \cdot 10^{-3}$

Ejection of a Debunched Beam

Ejection tests were also made with an adiabatically debunched beam⁸⁾ in order to reduce the momentum spread. No difficulties were observed in conjunction with the shaving process. Figs. 7 a and b show a typical ejected beam current signal after debunching. The structure of the ejected beam is due to imperfect debunching; unwanted coupling impedances of CPS equipment are likely causes of the structure.

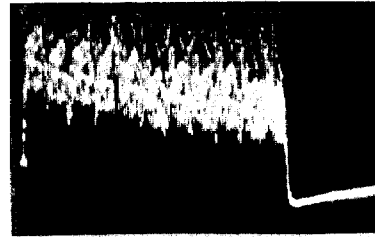

FIG. 7 a)
 (5ps/cm; unfiltered)

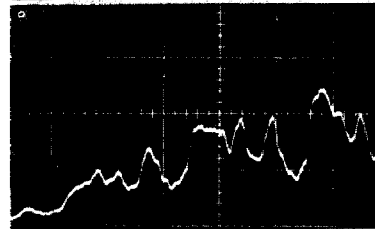

FIG. 7 b)
 (100ns/cm; unfiltered)

FIGS. 7 a + b: STRUCTURE OF EJECTED BEAM AFTER DEBUNCHING

Stability of the Shaving Operation

The pulse-to-pulse stability of the peeling process achievable with the experimental set-up can be inferred from Fig. 8. A bunched beam is slightly more unstable than a debunched one (probably due to the influence of the beam control system during the establishment of the slow bumps).

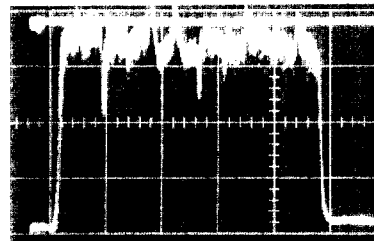

FIG. 8: SHORT TERM STABILITY OF EJECTED BEAM INTENSITY AFTER ADIABATIC DEBUNCHING. RF STRUCTURE FILTERED OUT; 20 SHOTS SUPERIMPOSED; 5us/cm.

Drifts observed during periods of several hours could be cured by slight readjustment of the radial beam position at the ES. The sensitivity to variations of several parameters was tested: parameter variations which brought approximately 10% modulation of the ejected beam current were:

- slow bump at ES : -0.3%
- current of fast bumpers : -1.5%
- mean radial beam position : -0.3mm (during acceleration)

As an example, Figs. 9 a,b,c, show the influence of beam position variation at the ES on the ejected beam. The ES angle is not critical within ± 0.2 rad.

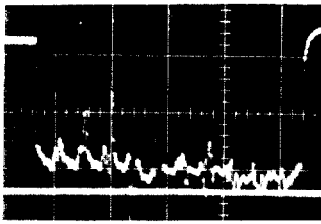

FIG. 9 a)
NO VARIATION

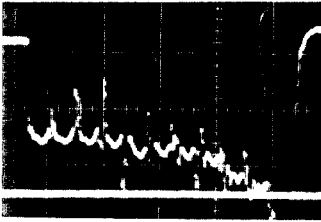

FIG. 9 b)
VARIATION BY -0.8 mm

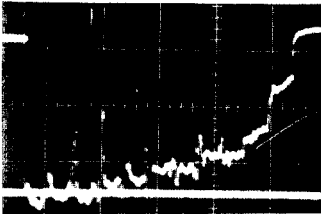

FIG. 9 c)
VARIATION BY +0.8 mm

FIGS. 9 a,b,c : EJECTED BEAM CURRENT (5 μ s/cm; RF STRUCTURE FILTERED OUT). EFFECT OF CHANGE IN BEAM POSITION AT ELECTROSTATIC SEPTUM

Conclusion

The tests have shown that a multiturn shaving extraction can be handled without major problems. It shows

good stability, the parameter tolerances are reasonable, the efficiency is comparable with other, already well established extraction schemes. Since this type of ejection can handle bunched and debunched beams and the ejection duration can be easily varied, it is a flexible instrument for the transfer of beams between synchrotrons.

Acknowledgements

We like to express our gratitude to D. Boussard, D. Grier, P. Pearce, K.D. Metzmacher, F. Rohner and the ISR department for their contribution to these studies.

References

- 1) K.H. Reich - Decaturn Beam Extraction for Synchrotrons. BNL AADD-100 (April 1966).
- 2) Injection into the 300 GeV Synchrotron from the CPS. CERN/MPS-SI/Int./300/INJ/4, 12.12.1970.
- 3) C. Bovet - Continuous Transfer from CPS to 300 GeV. A Numerical Analysis of Fast Shaving Ejection. CERN 300-DI-PA/INS-2, 25 June 1971.
- 4) F. Schäff - Arrangement of Elements in the PS for Continuous Ejection Tests. CERN 300-DI-PA/71-7.
- 5) J. Bleeker, C. Germain, M. Thivent, R. Tinguely - Development of an Electrostatic Septum at CERN for High Energy Proton Synchrotrons. CERN/MPS/SR 72-4, 21.7.1972.
- 6) D. Grier - Proposal for a Staircase Pulse Generator for Continuous Transfer from the CPS to the SPS. CERN MPS/SR/Note 71-36, 7.10.1971.
- 7) D. Fiander - The Fast Bumper Magnets and Associated Pulse Generators for 11 Turn Extraction of the PS Beam. CERN MPS/SR 72-2, 3.7.1972.
- 8) D. Boussard - Adiabatic Debunching Studies. CERN report in preparation.