

A Common 400Hz AC Power Supply Distribution System for CMS Front-end Electronics

C. Rivetta*, F. Arteché**, F. Szoncsó **

*FERMILAB, P.O Box 500 MS222, Batavia IL 60510 USA, **CERN, 1211 Geneve 23 Switzerland;
(Principal contact: rivetta@fnal.gov)

Abstract

A 400Hz AC system is proposed to distribute power to all CMS sub-detectors. It distributes high voltage to the periphery of the detector using a 208V three-phase system. On the detector, step-down converters transform the AC high voltage to appropriated DC low voltages. These units have to operate in a harsh environment with magnetic field and neutron radiation.

This paper presents the proposed power distribution system and describes the design considerations to distribute power quality to the front-end electronics. Special attention is paid to the analysis of steady state and transient perturbations that affect the quality of the sine wave voltage.

I. INTRODUCTION

Several LV distribution systems have been proposed for different CMS sub-detectors [1][2]. The proposed 400Hz distribution is a common system for the whole detector and tries to homogenize the voltage distribution between the counting room and the detector. This system distributes 208V three-phases to the periphery of the detector, where each sub-detector connects low-voltage (LV) units to convert the primary distribution into its required DC voltages. The system uses a low current distribution topology and reduces both the volume of transformers and filters operating at a frequency higher than the AC main frequency. This

To design and build a system that distribute power quality and perform reliably, it is necessary to define design conditions that allow integrating to the system all the LV units developed by the different sub-detectors and fulfil their requirements. In addition, general conditions have to be established to the loads to minimize the impact of steady state and transient perturbations.

This paper describes the proposed power distribution system, analyses design considerations putting special attention to the transient and steady-state perturbations.

II. SYSTEM DESCRIPTION

The proposed 400Hz AC system will be used as primary system to distribute power to the front-end electronics at CMS. The topology is based on Motor-Generators (M-G) that converts the 50Hz AC mains into a three phase 400Hz, 208V system that is distributed to the detector. Each sub-detector

will have its own M-G or set of M-Gs. A back up M-G unit will be installed and will be used as replacement of the original M-G in case of failure of any of unit or during maintenance. To facilitate the operation, M-Gs will not work in parallel in case one distribution system for a sub-detector is configured using several M-Gs. The proposed distribution system is depicted in figure 1 for the case of EMU/HCAL sub-detectors.

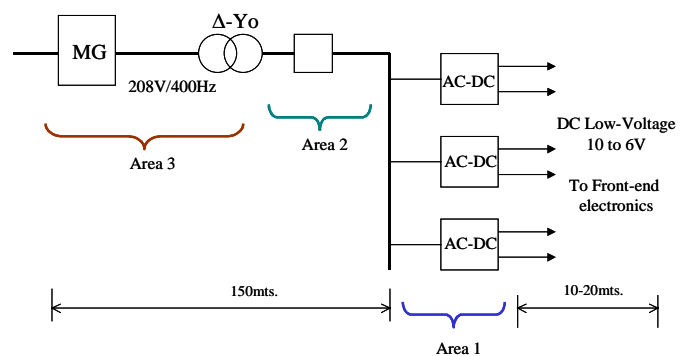

Figure 1: Distribution system scheme for HCAL/EMU sub-detectors

The estimated powers delivered to each sub-detector are:

ECAL/PRE-SHOWER \cong 250KW

HCAL \cong 30KW

MUONS: DT \cong 32KW; RPP \cong 32KW, CSC \cong 32KW

TRACKER / PIXELS BARREL \cong 60KW

In this case, units of 40-50KVA can be used to complete the design, setting more than one unit for the ECAL/PRE-SHOWER and TRACKER/PIXELS sub-systems. The goal is to distribute 3 phase / 208V between either the counting room or the surface of the CMS building and the periphery of the detector where each sub-system will connect its step-down low voltage (LV) system to bias the front-end electronics.

Sub-detectors have proposed different LV units. Some of them will use simple 3 phase transformer / rectifier units with inductive-capacitive output filters. The final LV regulation is achieved using linear low-voltage drop regulators located near the front-end electronics. In this system, rectifiers are located in the periphery of the detector and have to operate reliably under radiation and fringe magnetic field.

Other sub-detectors have proposed to use LV units based on AC/DC converters and DC-DC converters as post-regulators. In this equipment, the 400Hz distribution is converted to an intermediate 48VDC distribution and DC-DC converters perform the final step-down conversion to the

required low voltages. DC-DC converters will be placed around the detector where the environment conditions are similar to the one described above.

III. GENERAL DESIGN GUIDELINES

The need to provide power with a steady voltage and frequency is the most important goal of this AC distribution. Disturbances in the quality of power delivery can occur during normal operation of the system. These general guidelines try to evaluate the significant issues affecting the power quality of the distribution.

The input voltage level for normal operation of the equipment connected to the 400Hz AC distribution cannot change in wide range without affecting its performance. The minimum and maximum limits around the nominal voltage define the operative bounds for the equipment. Voltages over or under those limits can affect the performance or induce the risk of damage of the equipment. In addition to these steady state limits, there are others involving waveform distortion and deviation from the expected sine wave voltage. These disturbances can be enumerated as:

Amplitude variations can occur in several forms and their duration can range from a brief period of time to steady-state conditions.

Waveform variation occurs when non-linear loads (e.g. AC/DC converters) draw a current that is not sinusoidal. This disturbance can be transient or permanent. In the last case, it can be described or qualified using the harmonic distortion of the resulting voltage wave.

Dissymmetry or unbalance occurs when unequal single-phase loads are connected to a three-phase system. In the present proposal, this disturbance can be avoided forcing all the loads to be three-phase balanced systems.

Frequency variations: M-G-based distribution systems can experience frequency variation due to load variations and equipment malfunction. .

The origin of the disturbances in the present system will be mainly due to load switching and non-linear loads. Load switching disturbances occur whenever a circuit containing capacitance and inductance is switched ON or OFF. The transient disturbance severity depends of the relative power level of the load being switched and the short circuit current of the power system in which the switching takes place. Transient voltage surges can reach between 1-10 times the nominal voltage depending on the energy levels involved.

The distribution system and the loads have to include some type of protection against disturbances to allow a reliable operation of the susceptible equipment. To consider the application of protections, it is necessary the characterization of the environment and the characterization of the equipment. The first one has been briefly discussed in this section and extended in following sections, while the susceptibility of the equipment depends of its specific design.

IV. SYSTEM DISTURBANCES - SOURCES / CHARACTERISTICS

Based on the general guidelines described above, a more extensive analysis of the perturbations, their impact on the generation and distribution system and the related failure modes are addressed. Interaction between sensitive electronics equipment, their power sources and their environment result in transient disturbances or steady-state distortions to the system voltage waveform. Table 1, extracted from IEEE-Std 1100-1992 [3], summarizes these sources of voltage waveform disturbances and waveform distortions and their typical magnitudes.

Voltage parameter affecting loads	Typical immunity of Electronics loads	
	Normal	Critical
Over/Under-voltage	+10%,-15%	± 5 %
Swells/Sags	+20%, -30%	± 10 %
Transient, Impulsive & Oscillatory in power lines	Varies: 500 - 1500V	Varies: 200 – 500V
ESD	Varies: 200-500V	Varies: 15 – 50V
Voltage distortion	5-10%	3-5%
Phase Imbalance	5% max	3% max
Current parameters affecting sources	Typical Susceptibility of Power Sources	
Power Factor	0.8 lagging	0.6 lagging / 0.9 leading
Crest Factor	1-2.5	>2.5
Current Distortion	5-10% total 0-5% largest	5% max total 3% largest
DC current	< 1%	< 0.5%
Ground Current	< 0.5A	< 0.1A

Table 1. Matching Sensitive Loads and Power Source Requirements with Expected Environments [3]

A. Steady-State Voltage Disturbance – Voltage Regulation

As it was showed in table 1, in steady state is important to define the voltage limits around the nominal magnitude in which the equipment can perform under specifications. These limits are defined in the system by the voltage drop in transformers and distribution lines for different loads conditions. Table 1 suggests an over-voltage/under-voltage limit of +10% / -15 % for normal loads and ± 5 % for critical loads. To keep tight voltage requirements, 400Hz-wiring runs should be as short as practical. In the proposed distribution

system, these limits affect not only the own distribution topology but also the performance of the sensitive equipment.

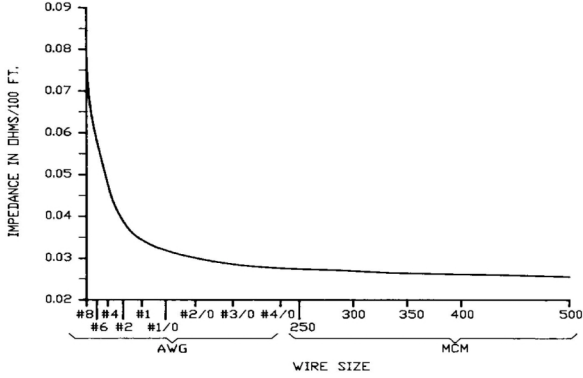

Figure 2: Wiring impedance of 400Hz versus wire size single copper conductors in aluminium conduit [4].

1) Voltage drop in the distribution lines

The cable impedance of the distribution lines is about 8 times the impedance at 50/60Hz having a strong effect in the voltage drop and voltage distortion. For 400Hz is recommended to use nonferrous conduits or pre-assembled 400Hz cables to reduce the series inductance. Metallic conduits are usually preferred because it provides electrostatic shielding of the power conductors. From ref. [4] [5], it is possible to get enough information about the impedance of cables at 400Hz to estimate the voltage drop in the distribution lines. Figure 2 depicts an important feature of cables operating at 400Hz. The cable series impedance per unit length decreases up to a wire size AWG 1/0 or a cross-section of 53.5 mm² and then it remains almost constant. For critical applications with tight voltage regulation it is preferably to put cables in parallel to meet the cable ampacity or to section the load in groups of lower power demand per distribution cable, to use in the design low-impedance wires.

The ampacity of 400Hz power cables requires some de-rating. At high frequencies, the effective cross-section of wires is reduced and a de-rating factor $\sqrt{R_{dc}/R_{ac}}$ has to be used to define the new ampacity.

2) Voltage drop in the distribution transformers and generator

Voltage generators can operate in closed-loop, sensing the voltage either near the generator terminals or at some remote distribution node. It provides adequate voltage regulation at the sensing point. When multiple loads are powered from one source, care must be exercised to provide acceptable voltage to all the loads under all possible conditions. Some limitations of the closed-loop operation include a limited compensation range, a relatively slow compensation response time and noise pick-up by the sense lines.

Distribution transformers can be included in the system to improve the noise isolation between the generator set and the loads. The equivalent series impedance of the distribution

transformer introduces an additional voltage drop within the distribution system. The magnitude of the series impedance can be estimated from electrical standards and it is about 3-10% of the base impedance of the transformer.

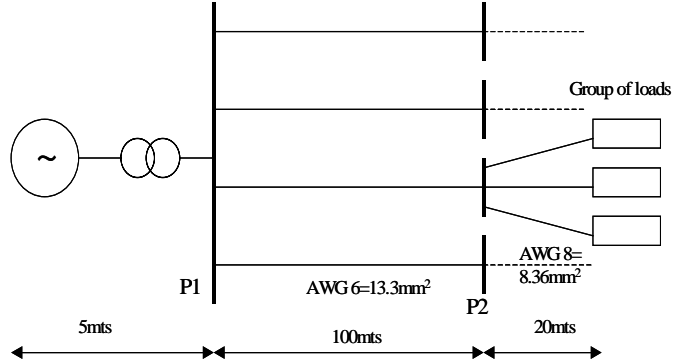

Figure 3: Example of a distribution system for HCAL sub-detector.

To analyse the voltage regulation of a CMS distribution sub-system, let us consider a possible power distribution for the HCAL sub-detector. Figure 3 depicts its topology, where four distribution lines runs between the generator and a distribution panel P2. The generator operates in closed-loop sensing the voltage at the generator terminals and there exist an isolation transformer between the generator and the load. In this case, the generator has a tight voltage regulation and the voltage drop now is due to the isolation transformer and the distribution line. The load terminal voltage can be expressed by

$$V_L = V_s - I.R \cdot \cos \vartheta - I.X \cdot \sin \vartheta - j.(I.X \cdot \cos \vartheta - I.R \cdot \sin \vartheta) \quad (1)$$

where V_s : source voltage vector, V_L : load voltage vector, I : load current vector, R, X , ac series resistance and reactance of the combination distribution wires/transformer, φ is the angle between the load current and the source voltage vectors.

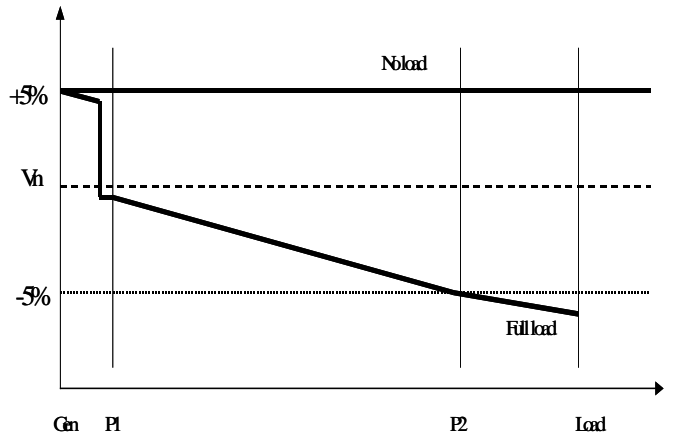

Figure 4. Voltage drop for the HCAL distribution system

Figure 4 shows the voltage profile of this distribution system for the extreme conditions of no load and full load. This example shows that it will be difficult to achieve, with the topology depicted in figure 3, a voltage regulation at the load better than $\pm 5\%$.

3) Performance of sensitive equipment

Assuming LV units are developed using a simple transformer/rectifier in combination with low voltage drop linear regulators, the power dissipated in the regulator depends on the regulation of the AC system. All the sub-systems that use this LV unit topology include rad-tolerant regulators designed by SGS-CERN collaboration [6]. The basic characteristics of these devices are: maximum input voltage = 12V (with an absolute maximum = 14V), output voltage range = 2.2V-8V, maximum output current = 3A, minimum input/output voltage = 0.5V per ampere output current. Assuming as example an operative current of 2A per linear regulator and a minimum voltage drop in the regulator of 1.5V in steady state. The increment of the dissipated power per LV regulator, for an input voltage variation of $\pm 5\%$,

$$\Delta P_D = 0.315W + 0.21A.V_{out}$$

If $V_{out} = 5V$, then $\Delta P_D = 1.36W$ respect to a minimum dissipated power of 3W, while if $V_{out} = 3.3V$, then $\Delta P_D = 1.0W$. It represents about 30% of variation of the dissipated power in the linear regulators respect to the minimum power dissipated. If the voltage tolerance at the input is $\pm 10\%$ the dissipated power variation is about 85% respect to the minimum power dissipated.

B. Steady-State Voltage Disturbance – Harmonic Distortion

All loads connected to the 400Hz distribution system are non-linear. They generate harmonic currents that interact with the distribution system impedance and produce distortion in the sine wave voltage. Harmonic are prejudicial because they over heat equipment, radiate noise, excite power distribution resonance if there exists, induce malfunction of sensitive equipment, etc. Operating at 400Hz, the harmonics extend in a range of frequencies higher than 50 Hz harmonics, inducing more problems. In this sense, harmonic standards for 400Hz systems are more strict that standards limiting harmonics in 50/60Hz systems.

Power generators and static converter generating a sine wave produce harmonic voltage as product of the conversion. Commercial generators specify a total harmonic distortion (THD) less than 4%, individual frequency voltage harmonics less than 3% and total deviation less than 3%, while static converters can produce an output sine wave with a THD better than 3% for all the load range. In both cases, the quality of the output waveform is very high.

It will be ideal to compensate harmonics at the point where they are generated, but in-situ compensation is not economic and it is more practical to force to the loads to reduce the number of harmonics injected to the distribution system. The definition of harmonic indices and limits are characterized by [7];

1. The values given by the harmonic indices should be physically meaningful and strongly correlated to the severity of the harmonic effects.
2. It should be possible to determine by measurements whether or not the limits of the harmonics indices are met.
3. Harmonic indices should be simple and practical so that they can be widely used with ease.

Harmonic effects differ substantially depending on the characteristics of the equipment affected. Therefore, the severity of the harmonic effects imposed on all types of equipment cannot be perfectly correlated to a few, simple indices. Recommended harmonic indices are: Individual and total voltage distortion, individual and total current distortion and depth of total notch area and distortion of bus voltage distorted by commutation notches.

The IEEE Std 519-1992 [7] describes the recommended practice to define harmonic limits for individual consumers at 50/60Hz. This standard defines the limits for individual loads based on the load size, load diversity, etc. The objectives of the harmonic current limits are to limit the maximum individual frequency voltage harmonic to 3% of the fundamental and the voltage THD to 5%. Current limits based only on voltage distortion are not complete because it assumes the unlimited ability of the generator and distribution system to absorb harmonic currents [8]. This standard defines the absolute harmonic current limits using similar criteria than above. For dedicated systems, as CMS, it limits the individual harmonic current for low order harmonics to 4%.

To estimate the effect of the load harmonic current, different configurations of three phase rectifiers coupled with a step-down transformer are used. For the first estimation, the transformer is assumed ideal and the effect of the switching overlapping of the rectifiers are neglected. Three phase rectifiers coupled by transformers have the advantage of using the winding connection at both the primary and secondary to cancel harmonics.

The topology of a three-phase full-bridge rectifier with a Delta/Wye transformer is depicted in figure 4a. Line-line and line neutral voltages and ideal line current waveforms are shown in figure 4b for this converter. The harmonic current levels and the voltage drop of those harmonic currents in the distribution lines are depicted in figure 4c. This analysis was carried out assuming a distribution line with a size wire AWG#7 with and a length of 100mts. At the end of the line, 15 power converters are connected. From figure 4c, the individual frequency voltage harmonic is about 2.3% that is close to the limit defined by the IEEE-Std 519. The individual frequency current limit defined by the same standard is 4% of the fundamental for harmonic orders lower than 11, and the converter analysed has the 5th harmonic component equal to 20% of the fundamental while the 7th harmonic component is 14.3%. If some of the limits presented here are going to be used in the 400Hz distribution, especial care must be taken to

reduce the harmonic content produced by the load using filtering or harmonic cancellation.

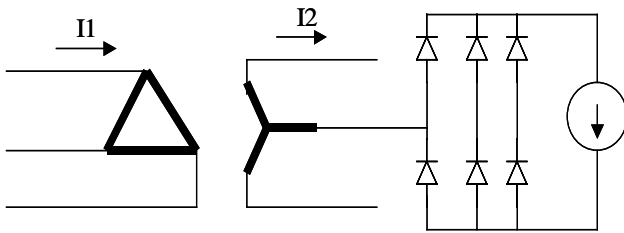

Figure 4a: Three-phase full bridge rectifier with Δ/Y transformer

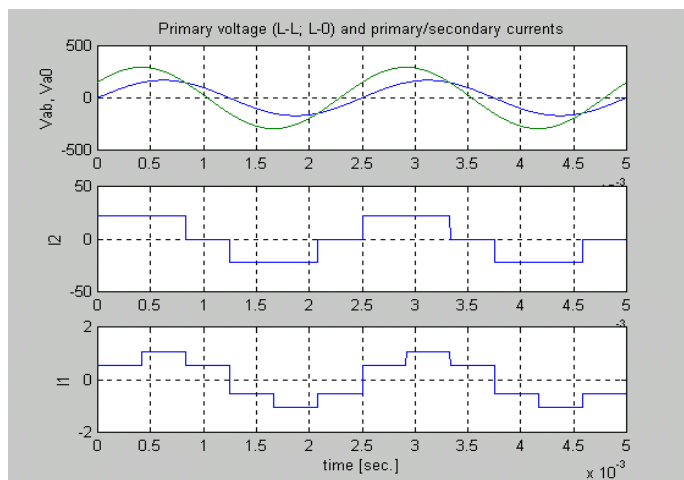

Figure 4b: Input Voltages and Currents

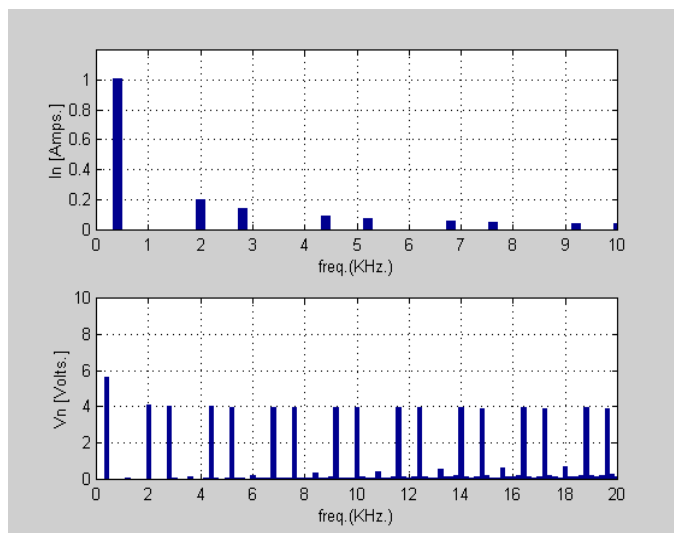

Figure 4c: Spectrum of the rectifier input current, Spectrum of the voltage drop in the distribution lines

C. Transient Voltage Disturbance

Load-related changes and switching events cause almost all voltage disturbances that occur between sensitive equipment and their power sources. Common load-derived sources of voltage waveform disturbances and their characteristics are:

1) Step Loads Step load changes are one of the most common sources of voltage disturbance. The basic cause of the voltage disturbance is simply the voltage drop caused by the load current and the power system impedance.

2) Inrush Currents Inrush currents, associated with power supplies can reach values of about 10-20 times the nominal current if no limiting circuits are included in the equipment. The initial energizing of transformers creates a magnetizing current transient, decaying to steady state in several cycles under worst-case conditions. Actual inrush current will depend on the phase angle of the initial voltage waveform and the state residual magnetic flux from prior transformer energizing. This issue is particularly critical for transformers located in the periphery of the detector where the detector's fringe field pre-magnetizes the core of the transformers. In addition, when rectifier/capacitor power supplies are energized, the initial capacitor charging can cause similar levels of inrush currents.

3) Fault Currents Fault currents represent an extreme case of transient current flow and thus AC line voltage disturbance. Depending on the power system impedance, several order of magnitude of normal full load current may be available. Severe voltage reduction to adjacent equipment usually results until the fault is cleared.

The impact of these disturbances can be the complete loss of local AC power, short-term voltage variations, data upset, frequency variations in the AC generated, etc. The complete loss of the AC power can occur locally when transformer inrush currents exceed the time-current trip curves of upstream over-current protection devices, causing loads to open circuit.

Due to these disturbances are unavoidable in a distribution system with the power level required in CMS, it is necessary to include in the design a combination of surge protection devices and proper design of the sensitive electronics equipment. Sub-detector should be sectioned in relatively small loads with limiting inrush current devices to reduce transients during turn ON. Additionally, load should be turned ON/OFF sequentially to avoid fast step loading to the distribution system.

D. Voltage Surges

Voltage surges are sub-cycle voltage transients. They are a particular concern for sensitive equipment. Small voltage surges can cause disruption of data, while high energy voltage surges are often responsible for the damage of components within the sensitive load. The most important sources of electrical surge in our distribution are switching surges. Switching surges are associated with rapid changes in current flow rates (di/dt) within a given electrical system. Switching sources are originated by interruption of current by fuses, circuit breakers and switches. The switching surge voltage is characterized by a fast rise time followed by a damped oscillation. If the switching arc is unstable, as the contacts open, the current is often interrupted and re-ignited several times (bouncing) before the stable open circuit.

The potential impact of surge transients depends on its severity and the susceptibility of the equipment. Three types of occurrences are possible.

1. Signal-data disruption: Circuits carrying signals are susceptible to surge interference via conductive, inductive, capacitive and electromagnetic coupling.
2. Gradual hardware stress and latent failures
3. Immediate hardware destruction.

Transient voltage suppressors (TVS) should be included in both the distribution system and the sensitive equipment connected to it. Proper coordination among TVS devices is necessary to divert the transient energy through the device with suitable rating. In addition when TVS are used, coordination with over-current protection should be evaluated. In low-voltage applications, the clearing time of fuses is affected by the connection of TVS at the distribution bus [9]. The clearing time increases because the surge protector absorbs part of the disruptive energy.

V. OVER CURRENT PROTECTIONS – DE-RATING

Over-current protections have to be properly coordinated in rating and clearing time along the distribution system. When 50/60Hz components are used in 400Hz applications, component de-rating is often required. Fuses are typically not appreciably affected by 400Hz power since they are principally resistive, but thermal-magnetic and magnetic-only circuit breakers are affected [3][4].

VI. GROUNDING

For the same safety and system performance considerations, the 400Hz system should be grounded as 50/60Hz systems. Proper grounding is essential for safe and satisfactory performance of the complete system. There are four basic requirements for such grounding:

Provide a low-impedance path for the return of fault currents, so that an over-current protection device can act quickly to clear the circuit.

Maintain a low potential difference between exposed metal parts to avoid personnel hazards.

Over-voltage control of sensitive electronics.

Grounding should be compatible with the system performance and noise without compromising safety.

The typical fault/personnel protection hardware is almost never of sufficient low-impedance either to reliably prevent unwanted development of *ground-fault-related potentials* enough to damage electronics or to carry *common mode currents* without interfering with signals and data. The grounding of the distribution system will follow the general grounding rules imposed to the CMS experiment [10].

VII. CONCLUSIONS

This paper has presented the design considerations for the CMS 400Hz power distribution system. This analysis is not conclusive. A better understanding of the impact of environmental conditions (magnetic field and radiation) on protection devices, switches and load performance is necessary to define the final topology of the distribution system. Finally, based on the quality of the voltage waveform and the system reliability it is necessary to define the systems specifications.

VIII. ACKNOWLEDGEMENTS

One of the authors (C.R.) wants to thank to Fermilab PPD-EED for the support to complete this work. This work was performed under contract # DEACO2-76CH03000 with the Department of Energy – USA.

IX. REFERENCES

- [1]- B.Betev et. al. “*Low Voltage Supply System for the Very Front End Readout Electronics of the CMS Electromagnetic Calorimeter*” in *Proc Fifth Workshop on Electronics for LHC Experiments*, 20-24 Sept 1999.-
- [2]- B. Allongue et.al. “*Design Considerations of Low Voltage DC Power Distribution for CMS Sub-Detectors*” in *Proc Sixth Workshop on Electronics for LHC Experiments*, 11-15 Sept 2000.-
- [3]- IEEE-Std 1100-1999 “*IEEE Recommended practice for powering and grounding electronic equipment*”.-
- [4]- T. Gruzs “*Design Considerations for Powering 415-Hz Computer Systems*” IEEE Trans. on Industry Applications, vol. 25, No 6, 1989.
- [5]- C.R. Paul, *Introduction to Electromagnetic Compatibility* NY:Wiley-Interscience,1992, ISBN-0-471-54927-4
- [6]- <http://lhc-voltage-regulator.web.cern.ch/LHC-Voltage-regulator/>
- [7]- IEEE-Std 519-1992 “*IEEE Recommended practice for Harmonic Control in Electrical Power Systems*”.-
- [8]- T. Gruzs “*Uncertainties in Compliance with Harmonic Current Distortion Limits in Electric Power Systems*” IEEE Trans. on Industry Applications, vol. 27, No 4, 1991.
- [9]- A. Beutel, J. Van Coller “*The effect of Silicon Avalanche Diodes on Fuse Behaviour in LV Power Networks*” IEEE Trans. on Industry Applications, vol. 38, No 3, 2002.
- [10]- F. Artech, F.Szoncso “*Earthing at CMS*” Pre-print.