

MAJOR PROJECTS FOR THE USE OF HIGH POWER LINACS

M. Promé
CEA/DSM

Saclay, 91191 Gif/Yvette France

Abstract

A review of the major projects for high power linacs is given. The field covers the projects aiming at the transmutation of nuclear waste or the production of tritium, as well as the production of neutrons for hybrid reactors or basic research with neutron sources. The technologies which are common to all the projects are discussed. Comments are made on the technical difficulties encountered by all the projects, and the special problems of the pulsed linacs are mentioned. Elements for a comparison of normal conducting linacs versus superconducting ones are given. Finally the technical developments being made in various laboratories are reviewed.

Introduction

It seems reasonable to place the lower boundary for "High Power Linacs" at the level of 1 MW average power. There is no upper boundary; some projects reach almost 200 MW. Most of these linacs accelerate protons (or H^+), with the exceptions of IFMIF (International Fusion Material Irradiation Facility), which is a deuteron accelerator, and of a CW electron linac designed for PNC (Power Reactor and Nuclear Fuel Development Corporation in Japan) [1].

The main purpose of these proton or deuteron linacs is the production of neutrons, by spallation for the proton linacs, or by breaking the deuteron for IFMIF. As far as spallation is concerned, there is a possible trade off of beam current against energy. Above 1 GeV, the number of produced neutrons is roughly proportional to the beam power.

The neutrons are intended to be used in 4 main classes of applications:

1. For transmutation [2], either for treating nuclear waste or for producing tritium. Transmutation requires beams with a power above some tens of MW. For such a power the CW mode is the most convenient and the chosen energy varies from one project to another from 600 MeV to 1.7 GeV, depending of the neutron flux needed and the technology chosen for the high energy part of the accelerator (normal conducting or superconducting cavities). The beam spot is enlarged from the centimeter size at the linac exit to the meter size on the target. For such a large magnification, non linear optics is usually preferred to other systems like raster scanning or linear optics. A non linear optics can give an almost homogeneous power deposit on the target area and is less sensitive to beam displacements at the linac output.
2. Future hybrid reactors are subcritical reactors where the deficit in neutrons is compensated by the neutrons produced by a proton beam shooting directly into the reactor core. Here a CW beam is required, with a power in the range of 10 to 30 MW. On the low side of this range, cyclotrons may be competitors to linacs [3].
3. For basic research with neutrons [4]. Here one needs pulsed neutrons, with a pulse length of about 1 μ s. The so-called

research reactors have up to now produced abundant continuous neutron fluxes for research in physics. These neutrons have the advantage of being thermalized at a temperature which can be chosen to some extent. But it is very difficult to get pulsed neutrons from reactors (an essential feature for time of flight measurements) without reducing drastically the averaged flux. Most proposed neutron sources are based on accelerators, which can easily produce pulsed beams. In addition, it is not so difficult to obtain the needed public acceptance for a new accelerator than it is for a new reactor. There is no criticality risk with accelerators, and they do not produce long lived radioactive waste in the spallation target. Even if a pulsed mode of operation is more natural for accelerators than with reactors, one cannot get at once from a linac a large average power in very short pulses. This is the reason why a rather long linac pulse is injected into a synchrotron or a storage ring in a multiturn injection mode, then extracted on one turn. The ring behaves as a compressor, or an accelerator-compressor. An efficient multiturn injection requires a non-Liouvillian mechanism: the linac accelerates H^+ which are converted into proton when passing through a stripping foil.

4. Irradiation of materials. IFMIF is designed to evaluate the damages in materials created by 14 MeV neutrons, those which are created in the deuterium-tritium reaction of the future fusion reactors. This neutron energy is the reason for the choice of 30 to 40 MeV for the accelerator. To get the required neutron flux, one has to accelerate a rather large beam current.

Regarding the project of the electron linac mentioned above, it is intended to produce a large photon flux for the treatment of nuclear waste by photo-reactions.

There are common features to all the linac projects (except the electron linac to which the rest of this text does not apply). They consist of an ion source, a RFQ, a DTL section (more or less modified) leading to roughly 100 MeV, and a high energy part, usually referred to as CCL (coupled cavity linac). When the beam current at the linac output is in excess of 100 mA for protons, (or below for H^+), the first part of the linac (ion source, RFQ and sometimes a part of the DTL section) is doubled. The two beams are then mixed in a funneling process, which consists in interleaving the bunches with the help of an alternate radial deviation produced by an RF cavity. When funneling is used, it is mandatory that the cavities after the funneling use a frequency being an even multiple of the cavities before the funneling (usually twice).

Normal conducting versus superconducting cavities

As pointed out by R. Jameson [8], "The age of adventure (high risk) in SC is over... Projects can decide to use RT or SC technology on the basis of their performance, cost, availability, flexibility, and upgradability requirements". One will see below that almost all the major projects of high

power linacs considered using SC. Most projects are based on RT cavities, with SC as an option, with the exception of the Japanese project that is now rather based on SC. For projects with superconducting cavities, the RFQ and DTL section still in standard room temperature technology. Only the high energy part involves superconducting cavities (but this high energy part represents 90% of the investment). However, SC low energy cavities are being considered for IFMIF as an alternative solution (a Toshiba design, see [8]).

It may not be unuseful to summarize here the classical arguments in favor of SC or against it, since they apply to almost all the projects described below.

1. With the same beam hole, the accelerating gradient may be larger than for RT, reducing significantly the linac length. But actually the usable gradient is not as high as one could think, because the possibility of entering a large amount of RF power per unit length along the linac is limited.

2. Alternatively, with the same gradient one can choose a much larger beam hole, hence a reduced risk of cavity activation.

3. SC cavities are usually short, due to the limited power passing through a single RF coupler. Therefore the cavities have a large velocity acceptance. The same cell length can be applied to large parts of the linac, offering the possibility of having spare cavities.

4. The needed RF power is less for SC as it is for RT, since there are only small losses in the cavity walls. But these losses occur at very low temperature (2 K or 4 K) and cost about 1000 times more at 2 K (or 300 at 4 K) to be evacuated as compared to the same losses at room temperature, requiring powerful cryogenic plants.

5. SC cavities must have thin walls to be efficiently cooled. Lorentz forces mechanically deforms the structure when operated at high gradient. This is a problem especially for pulsed linacs.

6. RF couplers for SC cavities is a subject of concern.

7. Investment cost is not larger for SC than for RT (possibly smaller).

8. Operating cost is smaller for SC.

9. Reasonable prices for CW RF power can be obtained only with large (1 MW) units. Therefore the power must be split between several cavities (4 or 8). This applies for both SC and RT, but RF level and phase is more difficult to control for SC cavities when several of them are fed by a single RF source.

10. SC offers the possibility of upgrading the linac to higher energy and current as the performance of couplers and windows is improved.

SC clearly appears as an emergent technology, but a quantitative study of cost and risk benefits has yet to be done [8]. It appears that the weight of each of the arguments above is evaluated for each project depending of the local context.

The European Spallation Source

The first phase of the studies for a European Spallation Source is now reaching its term, that is to say that a choice has been made between several possibilities [4-7]. The chosen configuration, at room temperature, is shown on Fig. 1. It consists of a 1.33 GeV H^- linac and two compression rings.

The requirements for the proton beam on the target are the following:

1 μ s long proton beam on the target

50 Hz repetition rate

5 MW average power

(actually there will be a second target accepting 1 MW at 10 Hz)

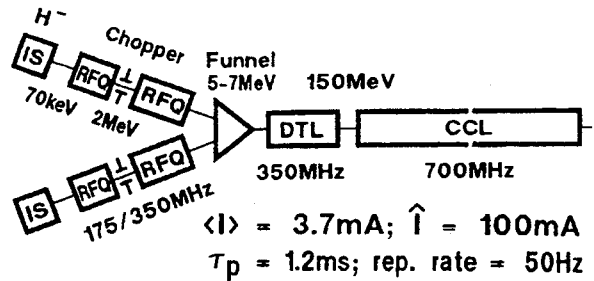

Fig. 1 ESS LINAC, 1.33 GeV, 5 MW.

It may be noted that each proton pulse carries an energy of 100 kJ, which is the subject of some concern with the building of stress waves in the target, and the reason for choosing a liquid (Hg) target.

The linac beam pulse is 1.2 ms long, working at 50 Hz. The injection into the rings must be made in such a way that the rings are not homogeneously filled (40% of the circumference is void), a condition necessary for an efficient extraction. So the 1.2 ms pulse is sliced in 360 ns long micropulses, separated by 240 ns gaps.

As one can see on figure 1, it has been impossible to avoid a funnel, which takes place at the level of 5 to 7 MeV. With the present state of the art for H^- sources, it would be too difficult to get the required peak current of 100 mA at the linac output with a single ion source. Moreover, the RFQ behaves better for moderate currents. The DTL section is a classical one. The quadrupoles are pulsed in the first cavity to ease the cooling problem in very short drift tubes. An accelerating gradient E_0T of 2.8 MV/m and a synchronous phase of 25° are chosen. It must be noted that such a gradient is substantially higher than the gradients chosen for CW RT linacs, which usually stay at the 1 MV/m level. But the 6% ESS duty cycle allows a gradient comparable to injector linacs, where the power dissipated in the walls can be easily evacuated.

The RF system for the high energy part of the linac consists of 66 4 MW peak power klystrons feeding 264 cavities. That is to say that 1 MW is available for each cavity. The power going into the beam and the cavity wall amounts to 0.75 MW. Field and phase stabilization respectively at 1% and 1° require the 0.25 MW extra power. This is particular to pulsed linacs, where the transient behavior requires a sizable percentage of the total RF power to be correctly mastered.

Side coupled or disk and washer cavities are proposed for the high energy part of the linac. The cavity length (1.27 m to 1.95 m) is short enough to allow a constant cell length inside a cavity. Transverse focusing is provided by doublets located every second cavity. Doublets are favored over singlets as they give a more circular and smaller diameter beam.

Even if RT is the base line design, the ESS project considered the possibility of a SC linac from 150 MeV up to 1.33 GeV, or even 2.5 GeV with a halved current. Figure 2 shows a SC module which consists of a couple of 2 cell cavities. The chosen frequency is 352 MHz, hence the working temperature is 4 K. Several possibilities have been contemplated, with accelerating gradients in the range of 8 to 10 MV/m, RF power per input coupler from 300 to 500 kW and 200 to 300 cavities. The whole energy range can be covered with 20 different structures (20 different β).

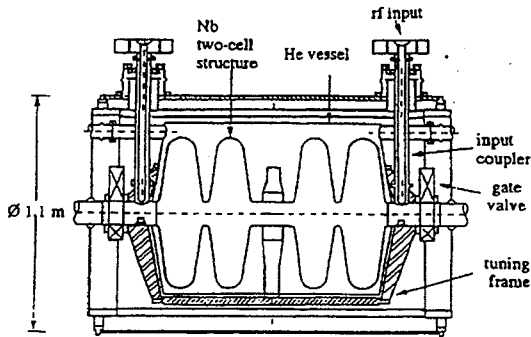

Fig. 2 Cryomodule for the ESS LINAC.

Other Spallation Sources

There is a large number of spallation source projects around the world [8, 9]. Most of them do not enter in the scope of this paper for various reasons: too low power linac, no linac at all. However it seems useful to mention of few of them:

1. The IPNS project (Intense Pulsed Neutron Source) at Argonne consists of a 400 MeV H^- linac with an average power of 400 kW and one RCS (Rapid Cycling Synchrotron) boosting the energy up to 2 GeV, or two RCS in cascade reaching 10 GeV. The average power on the target amounts respectively to 1 MW and 5 MW.
2. The 1 MW level is being reached on a spallation target at PSI near Zürich with a cyclotron.
3. LAMPF has been operating at Los Alamos with an average beam power exceeding 1 MW. It has been proposed [10, 11], to upgrade LAMPF for injecting into a accumulator/compressor ring. A single turn extraction would allow to obtain a 1 MW average power short pulse spallation source (SPSS). The LAMPF modification would consist in replacing the old part below 100 MeV by a new one including a 100 MeV H^- injector, RFQ and DTL sections, the side coupled cavity section being unchanged.
4. It must be noted that the Japanese high power proton linac project (see section 5) includes the possibility of injecting into a storage ring to obtain a short beam pulse to be sent onto a spallation target.

The Japanese project

JAERI proposed in 1984 a Neutron Science Research Program (NSRP) [13, 14]. At the core of this program is a 1.5 GeV proton linac with an average current of several mA. This program covers OMEGA (transmutation of minor actinides), basic neutron researches, nuclear energy related technologies on material science, neutron irradiation, radioactive beams, etc. JAERI originally proposed a pulsed

linac with a 100 mA peak current and 10% duty cycle. An important R/D work has been made for the front end portion of this linac (see section 9). JAERI has now modified the original proposal to meet new requirements. Figure 3 shows the conceptual diagram of the accelerator as it is now. One can see that the high energy part of the linac, above 100 MeV, uses SC cavities. The linac will be operated first in a pulse mode for a spallation neutron source, with a 1 mA average beam current in 2 ms long pulses at 50 Hz, and a H^- source. In a second stage the linac will be operated in a CW mode, the current being raised progressively up to 10 mA in protons. An ultimate goal could be several tens of mA.

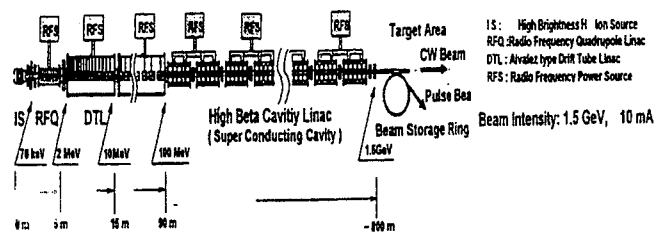

Fig. 3 The Japanese Project.

In addition to the classical advantages in favor of SC (see section 2) there is here another one: the linac length can be substantially reduced, an important point knowing the limited space available at Tokai-Mura. One drawback in shifting to SC is the necessity to modify the front end design to accept a CW operation. Presently the RFQ is designed to work with a 10% duty cycle and the hot test model of the DTL for 20%. For a reliable operation in a CW mode, the maximum electric field will be reduced from 1.68 EK (Kilparick limit) down to 1.43 EK.

The chosen frequencies are 200 MHz for the RFQ and the DTL and 600 MHz for the SC section. The EIMAC tetrode tube used for the front end has an output peak power of the order of 1 MW. The conceptual design work for high power CW tetrodes and klystrons has been started, taking into account the two modes of operation, pulsed and CW.

Figure 4 shows the schematic drawing of the SC cryomodule. For a maximum electric field of 16 MV/m and an iris radius of 7.5 cm, the accelerating field $E_0 T$ is (in MV/m):

- 2.90 at $\beta = 0.45$
- 5.67 at $\beta = 0.73$
- 7.18 at $\beta = 0.88$

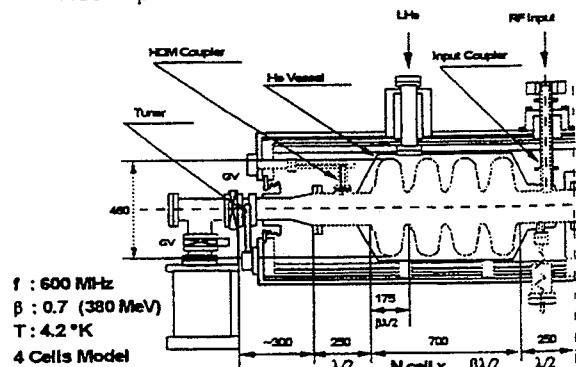

Fig. 4 Half of a cryomodule for the Japanese Project.

With a synchronous phase angle of 30° the total active length is of the order of 250 to 300 m, for a physical total length of 650 to 750 m.

IFMIF

IFMIF is the project of an International Fusion Material Irradiation Facility. The main motivation for IFMIF is to test the behavior of materials which could be used for DEMO, the Tokamak to come after ITER, presently being designed. The neutron flux should produce 50 dpa (displacement per atom) per year in a volume of 0.1 litre and 1 dpa/year in 10 litres. The IFMIF requirements will be met by two 125 mA, 40 MeV CW deuteron linacs operating in parallel. The target will be a curtain of molten lithium flowing with a speed of 15 m/s.

The IFMIF accelerator is shown on Fig. 5. A dual ion source (one operating, one in stand by) generates a 140 mA deuteron beam at 100 keV. Then an RFQ accelerates 125 mA up to 8 MeV. The final section of the accelerator consists of DTL cavities. Both the RFQ and the DTL are operated at the relatively low frequency of 125 MHz, a conservative approach to minimize the beam losses. There will be ten 1 MW RF power units per linac.

The 8 MeV RFQ is 11.7 m long. It is segmented in 3 longitudinal RF segments that are resonantly coupled through irises in the intermediate end walls. This gives a fair separation of the operating mode from the unwanted longitudinal modes of the RFQ. Each of the 3 RF segments is made from 4 physical pieces. The needed RF power is about 3 MW. All the losses (from 140 mA to 125 mA) occur below 2 MeV.

The DTL section consists of 7 Alvarez cavities with post couplers, each fed by a 1 MW unit. The control of the resonant frequency will be made by controlling the temperature of the cooling water. The inner diameter of the drift tubes is 3 cm, the goal for current losses being 3 nA/m. It should be noted that the accelerator may be operated with no acceleration in the last (or the two last) cavity, providing a selectable output energy of 30, 35 or 40 MeV.

The accelerator will be operated with H_2^+ to avoid activation during testing periods, and pulsed for tune-up and start-up. The beam calibration station (see Fig. 5) will accept the full intensity only with a duty factor $< 2\%$.

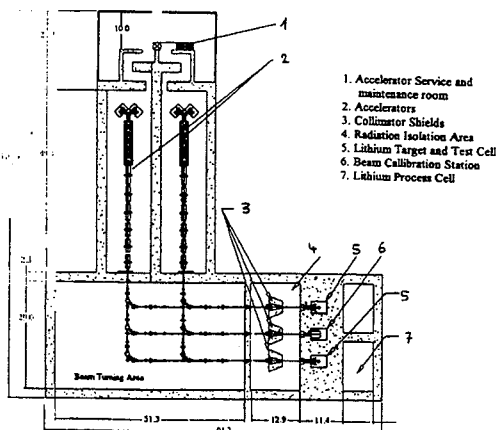

Fig. 5 IFMIF general lay out

The high energy beam transport is basically a FODO channel including "momentum compactor" cavities to fulfill the requirement that the energy dispersion on the target be limited to ± 0.5 MeV. The beam spot on the target must be $5 \times 20 \text{ cm}^2$ with a flat top uniformity of $\pm 5\%$. So there is a beam expander section which comprises 2 octupoles separated by 2 quadrupoles. An energy dispersion cavity broadens the beam energy distribution in order to spread the Bragg peak and reduce the maximum power density in the lithium curtain. To prevent beam scraping throughout the channel, a large beam pipe radius is chosen (12 cm). In addition to the achromatic 90° bend that can be seen on figure 5, there will be a 10° kick so as to shield as much of the final optics from the backstreaming neutrons as possible.

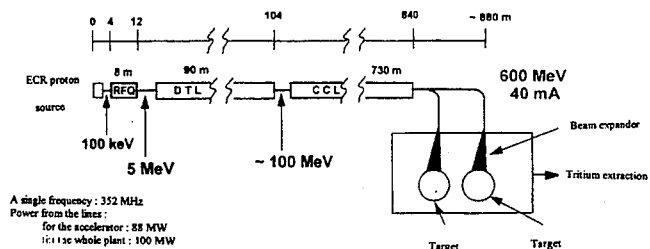

Fig. 6 TRIPAL general lay out.

A thorough RAM (Reliability, Availability, Mintenability) study has been made for IFMIF. The expected availability of the accelerator itself is 88%. It is estimated that the accelerator is designed with sufficient derating but no significant upgrade capability. Additional beam current, if desired, would be provided by adding other 125 mA modules.

TRISPAL

TRISPAL (TRITium, SPALLation) is the French project for the production of tritium by spallation. The parameters have been changed since a previous presentation [16]. It is now estimated that the amount of tritium to be produced per year will be covered by a 600 MeV proton accelerator with a 40 mA beam operating in the CW mode. The design of the accelerator is deliberately conservative, for a number of reasons. The goal is here to convince that an accelerator is as reliable as a nuclear reactor. The key words are: feasibility, reliability, proven off the shelf technology, existing RF tubes. This is the reason for a CW low current, low energy pulsed accelerator, a single RF frequency for which klystrons do exist (350 MHz), of course no funneling, and RT technology, even is a SC version is envisaged as an option.

Figure 6 shows the general lay out of the accelerator, which consists of an ECR proton source, a 5 MeV RFQ working at 1.7 EK, a DTL section up to about 100 MeV, and a CCL section. Then there is a transport channel to the 2 targets, only one being used at a time. The system includes a 82° bend, a FODO channel, a non linear expander and a final 8° bend to avoid backscattered neutrons. The beam spot on the target is a square with a side of 60 to 80 cm.

The chosen CCL uses the slot coupled structure working at the π mode, similar to the LEP RT cavities or the ESRF

cavities, with adequate cell length according to the β . Several comments must be made on this choice. First on the frequency: it seems that a 750 MHz CCL would offer a shunt impedance better by a factor $\sqrt{2}$; this is untrue if one keeps the beam hole the same at 750 MHz as it is at 350 MHz; in that case one can show [17] that, on the average from 100 to 600 MeV, the effective shunt impedance is roughly the same in both cases; what is lost in Z_s is gained on T and $Z_s T^2$ is conserved. The second comment is about the chosen structure; the choice has been made between several possibilities on the ground of construction cost; moreover, there was some suspicion on the behavior of on axis coupling structures under heavy beam loading (the field in the coupling cells may cause multipactoring problems); the fact that the π mode has a zero group velocity is a question of concern for long cavities, but not here for 5 to 7 cells cavities (same cell length inside a cavity). Coming to the RF system, a single 1 MW klystron feeds 8 cavities working at an average effective field $E_0 T$ of 1.12 MV/m. There will be 40 klystrons, for an active length of 500 m. It may be noted that here is some derating of the klystrons: for a nominal 1.3 MW power, they will be operated at 1 MW for a better reliability.

There is no serious feasibility problem for the DTL section, even if lodging DC quadrupoles in the first drift tubes is not easy. However one can have second thought about the necessity of quadrupoles inside the drift tubes. It is a technology which is rather expensive due to the mechanical difficulties of feeding and cooling the quadrupoles, but also the stringent radial tolerance on the drift tube positioning. The tolerance could be substantially relaxed were it not for the quadrupoles. Structures with quadrupoles outside of the drift tubes have been proposed at Los Alamos (see section 8). The TRISPAL project has a somewhat different approach. It is well known that the effective shunt impedance for DTL is better for long cavities where the end walls have a small relative contribution to the losses. This is true, but if one compares a good long cavity with quadrupoles inside the drift tubes to a short cavity (let say 5 cell) with drift tube shape optimized without worrying for a quadrupole inside, then one ends up with a better effective shunt impedance for the short cavity [17]. This is what is being investigated now as a possibility for optimizing the TRISPAL construction cost.

APT

APT, the Accelerator for Production of Tritium, is the most advanced project of a family of accelerators studied at Los Alamos for several years (transmutation of waste, plutonium burning, energy production [2]). The present base line is a RT 1.3 GeV proton linac; there are two versions, depending on the quantity of tritium to be produced per year: one with a 100 mA beam, the other with 134 mA; in the latter case there are two front end accelerators and a funnel. Figure 7 gives the main parameters. It is worthwhile to point out that the classical Alvarez DTL section has been replaced by a CCDTL section (Coupled Cavity Drift Tube Linac) [18, 19]. This structure is the solution chosen by Los Alamos to the problem mentioned above (see section 7), after imagining and rejecting an other solution, the BCDTL (Bridge Coupled Drift Tube Linac). One

can almost say that the construction of the front end part (RFQ, CCDTL) has already begun under the name of LEDA (see section 9). The CCL section consists of side-coupled cavities. It is estimated that the RT CCL technology is very mature; only a modest effort will be needed to carry out the conceptual design of this base line high energy part of the linac.

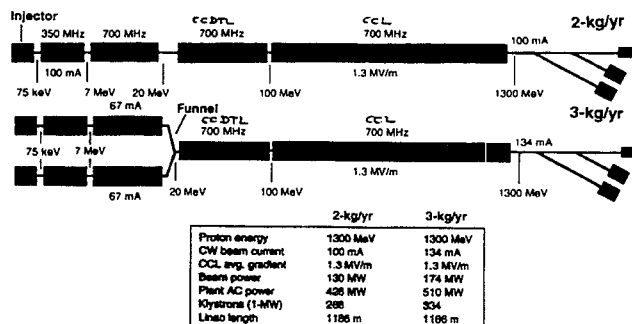

Fig. 7 APT room temperature linac (baseline).

But it is also believed that an SC solution should be emphasized for this high energy section. One can see on figure 8 the two versions of this SC linac: same front end part as RT, SC from 100 MeV up to 1.3 GeV or 1.7 GeV depending on the quantity of tritium. In both versions there is a 100 mA beam, hence no funnel. Cryomodules have been designed for two or four 4 cells cavities. the cavities are equipped with stiffeners to reduce mechanical vibrations. The decision of SC becoming the base line will be taken when electrical and mechanical performance of single cell cavities are confirmed, and when questions concerning the radiation tolerance of niobium are answered. Single cell cavities are now being fabricated and an experimental program for the niobium behavior under radiation has been started.

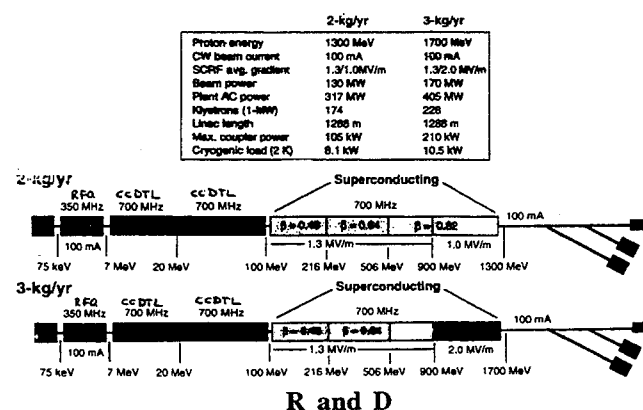

Fig. 8 APT superconducting linac.

RFQs have been one of the major breakthrough in accelerator technology. They do work perfectly well in CW mode for low currents, as cyclotron injectors, for instance. Or for high pulsed currents as synchrotron injectors. However their reliability when applied to large CW currents has to be confirmed. It is the nature of RFQ that the focusing field cannot be tuned separately from the accelerating field. High current means strong focusing, high fields, high power density

in the walls; a CW operation brings the difficulties of cooling the structure and avoid sparking between the vanes. There is little experience around the world with the operation of CW RFQs and DTLs [20, 21]. So it would be unwise to start the construction of a large CW linac without a deeper acquaintance with the technology of CW RFQs and DTLs, and also their daily behavior. This is the reason why several laboratories decided to build a front end part of a future large linac.

The Japanese started at Tokai-Mura an important program consisting of a proton source and an RFQ working at 10% duty cycle, and a DTL hot model without beam [22, 23]. The proton source has given 140 mA, of which 120 mA are protons, and the RFQ accelerated 70 mA with a duty cycle reduced to 7%. The measured transparency was 70% for a design value of 95% [14]. This front end was tailored to a pulsed project which is now shifted to CW (see section 5), so it has to be accordingly modified.

At Los Alamos, where RFQ tradition is strong, an "Accelerator Performance Demonstration Facility" has been proposed [24, 25]. A new version, LEDA, (Low Energy Demonstration Accelerator) is now under construction. It is intended to provide design confirmation and operational experience. LEDA will be a nearly exact replica of the APT accelerator front end, 100 mA CW, but will include extra diagnostics and instrumentation. It consists of a proton source, a 6.7 MeV RFQ and a 20 to 40 MeV CCDTL, with an "almost seamless" transition between the RFQ and the CCDTL section. The 8 m long RFQ is made of 4 segments stabilized by resonant coupling.

At Saclay an ion source named SILHI is being constructed. Oriented for TRISPAL and IFMIF, it will be able to deliver CW currents of 100 mA in protons or 140 mA in deuterons. It has been decided recently to go further: the now authorized IPHI program will consist of a 7 m long RFQ plus a 6 m long DTL, accelerating protons up to 12 MeV. Of course the RFQ and DTL design will benefit from the studies made for TRISPAL.

References

- [1] "PNC high power CW electron linac status", T. Emoto et al., LINAC-94, Tsukuba, page 181.
- [2] "Transmutation and energy production with high power accelerators", G. Lawrence, PAC-95, Dallas, page 35.
- [3] "Important design issues of a high efficiency cyclotron complex to drive the energy amplifier", P. Mandrillon et al., EPAC-96, Sitges
- [4] "Spallation neutron sources", H. Klein, LINAC-94, Tsukuba, page 322.
- [5] "Outline design for the European Spallation Source", editors: I.S.K. Gardner, H. Lengeler, G.H. Rees, ESS report 95-30-M September 1995.
- [6] "Accelerator Physics of High Intensity Proton linacs", K. Bongardt, M. Pabst, EPAC-96, Sitges.
- [7] "The European Spallation Source Study", 13th Meeting of the International Collaboration on Advanced Neutron Sources, PSI, 1995
- [8] "Discussion on superconducting and room-temperature high intensity ion linacs", R. Jameson, EPAC-96, Sitges.
- [9] "Conceptual Design for One Megawatt Spallation Neutron Source at Argonne", Y. Cho et al., PAC-93, Washington, page 3757.
- [10] "Feasibility Study of a 1-MW Pulsed Spallation Source", Y. Cho et al, PAC695, Dallas, page 363
- [11] "A Los Alamos Design Study for a High-Power Spallation-Neutron-Source Driver", A. Jason et al., PAC-93, Washington, page 3760.
- [12] "Linac-Driven Spallation-Neutron Source", A. Jason, PAC-95, Dallas, page 1183.
- [13] "A proposal of Neutron Science Research program", T. Tone et al., 10th Pacific Basin Nuclear Conference, October 1996, Kobe, Japan.
- [14] "Development of High Intensity Proton Accelerator", M. Mizumoto et al, 2nd International Conference on Accelerator Driven Transmutation Technologies and Applications, June 1996, Kalmar, Sweden.
- [15] "IFMIF Conceptual Design Activity Interim Report", JAERI memo 08-108, March 1996.
- [16] "Conceptual Studies for a High Power Proton Linac", M. Promé, LINAC-94, Tsukuba, page 146.
- [17] C. Bourat, private communication.
- [18] "A New RF Structure for Intermediate-Velocity Particles", J. Billen et al, LINAC-94, Tsukuba, page 341.
- [19] "A versatile, High-Power Proton Linac for Accelerator Driven Transmutation Technologies", J. Billen et al., PAC- 95, Dallas, page 1137.
- [20] "RF tuning and initial operation of RFQ1", B. Chidley, EPAC-88, Rome, page 544.
- [21] "Initial operation of a 100% duty factor 3 MeV Alvarez linac", J. Ungrin, PAC-81, Washington, page 3495.
- [22] "First beam test of the JAERI 2 MeV RFQ for the BTA" M. Mizumoto et al, LINAC-94, Tsukuba, page 113.
- [23] "Fabrication and test of the DTL hot model in the R&D works for the Basic Technology Accelerator (BTA) in JAERI", M. Mizumoto et al., LINAC-94, Tsukuba, page 119.
- [24] "Review of the APDF and other low-b, high-duty-factor linacs", R. Haedekopf, LINAC-94, Tsukuba, page 328.
- [25] "Accelerator Performance Demonstration Facility in Los Alamos", D. Chan et al, LINAC-94, Tsukuba, page 101.