

ELECTRON BUNCH POSITION DETERMINATION USING A HIGH FREQUENCY BUTTON BEAM POSITION MONITOR IN THE AWAKE FACILITY

B. Spear*, P.N. Burrows, John Adams Institute, University of Oxford, Oxford, United Kingdom
C. Pakuza, M. Krupa, S. Mazzoni, T. Lefevre, M. Wendt, CERN, Geneva, Switzerland
S. Lui, TRIUMF, Vancouver, Canada

Abstract

The AWAKE facility uses novel proton beam-driven plasma wakefields to accelerate electron bunches over 10 m of Rubidium plasma. Precise monitoring of 2 diverse beam types necessitates an electron beam position monitor (BPM) working in a frequency regime of tens of GHz. A high frequency conical button-style BPM with a working regime of up to 40 GHz has been investigated as a way to discriminate the electromagnetic fields of 19 MeV, 4 ps electron bunches propagating spatially and temporally together with a 400 GeV, 170 ps proton bunch in the AWAKE common beamline. The sensitivity of the HF BPM to the electron beam position is determined under various beam conditions, with both electrons and protons, and integration with a TRIUMF front-end is discussed.

INTRODUCTION

In the Advanced Wakefield Experiment (AWAKE) at CERN, a 400 GeV, 48 nC proton bunch from the Super Proton Synchrotron (SPS) is used to drive plasma wakefields in a 10m long rubidium vapor source. To ionize the rubidium vapor, a 100 femtosecond laser pulse delivering up to 500 mJ of energy is employed. Initially the proton bunches are 6 to 12 cm long, however, they undergo self-modulation in plasma, breaking into a series of microbunches that resonantly drive large wakefields. The self-modulation is seeded by the relativistic ionization front.

The proton beam, extracted from the SPS up to four times per minute, has a bunch population ranging between 1 and 3×10^{11} protons. Before entering the plasma, the beam is focused to a transverse size of 200 μm . When an electron beam is injected into the plasma at the correct position and phase relative to the proton microbunches, it can be accelerated through the wakefields generated in the plasma.

During the initial phase of AWAKE, known as Run 1 (2016-2018), the experiments successfully demonstrated the self-modulation process [1] and achieved electron acceleration from 18 MeV to 2 GeV [2], showcasing the potential of this novel acceleration technique. AWAKE Run 2 commenced in 2021, staged in four phases and due to operate over a number of years. The goal of Run 2 is to accelerate electrons to high energies (gradient of 0.5 – 1 GV/m), while controlling the beam quality and to demonstrate the scalability of the acceleration [3].

* bethany.spear@physics.ox.ac.uk

Table 1: AWAKE Nominal Beam Parameters

Beam	proton	electron
Energy / MeV	4×10^5	19
Charge /nC	48	0.1-0.6
Bunch Length /ps	250	1-5

The beam structure in AWAKE is distinct to this experiment, as outlined in Table 1. The variation in bunch length and intensity results in a frequency spectrum dominated by different bunch types in various regimes, as illustrated in Fig. 1. The existing electron beam position monitors (eBPMs), operating at 404 MHz [4], register a significantly stronger signal from the proton beam compared to the electron beam, making it impossible to distinguish the electron position when both beams are present. At 1.88 GHz, the spectral power of the two beams is equal if one assumes Gaussian bunch profiles. To isolate and measure the electron signal effectively, a much higher operating frequency in the tens of GHz range is necessary.

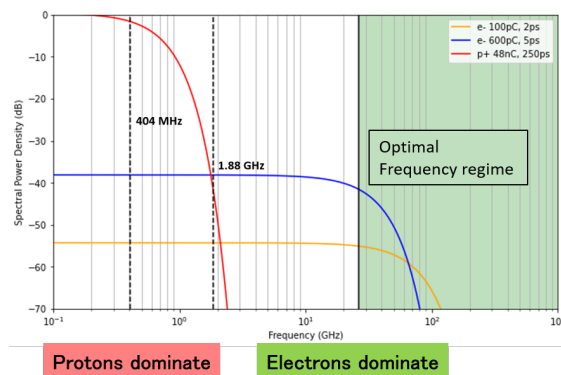

Figure 1: The Frequency spectra of the proton and electron bunches at AWAKE, assuming a Gaussian longitudinal bunch profile.

A HIGH FREQUENCY BUTTON BPM

The most widely used non-invasive beam position monitors are electrostatic, or capacitive pickups (PU). These pickups consist of 4 metallic electrodes placed symmetrically in the x and y planes of the beam pipe at the location where the beam position is to be measured. As the beam passes through the vacuum chamber, the horizontal and vertical displacement of the beam with regards to the centre of the beam pipe can be determined by the magnitude of the



Figure 2: An LEP button type BPM (left) with a cutoff of around 3 GHz, and the HF BPM (right) with a cutoff at 40 GHz.

induced current on the electrodes. In the case of a button pick-up, the image current generated on the electrode plate will be proportional to the beam current but opposite in polarity, and inversely proportional to the distance of the beam from the electrode plate.

The High Frequency beam position monitor (HF BPM), originally designed in DESY for time-of-arrival monitoring in FELs [5], consists of four symmetrically arranged conical buttons, and utilizes 2.92 mm vacuum feedthroughs that enable mode-free TEM operation up to 40 GHz. The large bandwidth is achieved by using a much smaller pickup design, shown in Fig. 2, compared to an LEP button-type BPM which has a cutoff frequency of around 3 GHz. This small size reduces unwanted eigenmodes outside the desired operating frequency regime.

The pickup design minimises higher order resonances due to the transition from the beampipe to the connector with an optimised conical shaped pickup.

AWAKE EXPERIMENTAL CAMPAIGN

There is currently one HF BPM body installed in the AWAKE common beamline, with four pickups allowing for beam position measurements in the horizontal and vertical planes. This is located approximately 3 m after the merging of the proton and electron beams, and 3 m upstream of the plasma cell.

The measurements involved performing a horizontal electron beam position scan, where all magnetic elements between the upstream corrector magnet, which was used to deflect the beam for the scan, and the final eBPM before the plasma cell were turned off and degaussed. This setup ensured a ballistic trajectory of the particle beam between the BPMs in the common beamline. The electron beam position was logged on three stripline eBPMs, also located in the common beamline, so that the beam position at the location of the HF BPM can be calculated. As the beam is moved across the horizontal plane, with the beam centred in the vertical plane, the incident voltage increases and

decreases depending on its proximity to the surface of the button. With a symmetric setup on both the left and right of the beampipe, the two sets of waveforms can be used to calculate a charge-normalised beam position signal. Using an average of the square root of the peak voltage of the waveforms recorded on the oscilloscope, the difference-over-sum ($\Delta U/\Sigma U$) calculation can be performed to determine the position sensitivity, S_x of the BPM using:

$$x \approx \frac{1}{S_x} \frac{\Delta U_x}{\Sigma U_x}. \quad (1)$$

This holds true for power-to-voltage front end systems such as a diode detector as used in these studies.

Electron Beam Studies

In order to benchmark the response of the HF buttons installed in the AWAKE beamline, electron beam measurements were conducted in parallel with numerical simulations. The Horizontal plane of the HF BPM was connected directly to an 8 GHz Tektronix Oscilloscope via a series of coaxial cables totalling approximately 10m in length. A 200 pC, 4 ps electron beam was then swept across the horizontal plane of the beampipe, and the voltage recorded at the oscilloscope. Jointly, a simplified model HF BPM was created in CST Studio Suite as shown in Fig. 3, and the numerical response to an electron bunch of similar parameters was simulated using the wakefield solver.

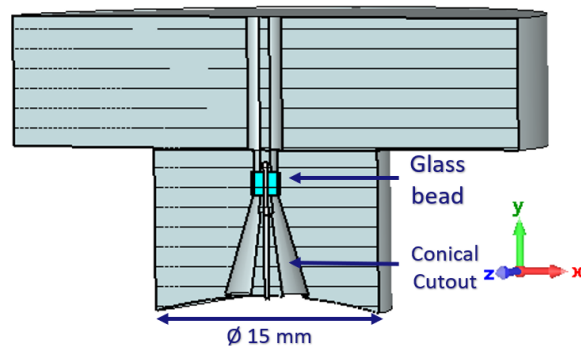

Figure 3: A simplified design of the HF BPM in CST, the button material is modelled with Aluminium, the beampipe as a perfect vacuum, and the metallic conical pickup as a perfect electrical conductor (PEC).

The voltages taken from the CST results were passed through an 8 GHz Butterworth filter using the Quite universal circuit simulator (Qucs) software. The position sensitivity was calculated using Eq. 1. The comparison between the simulated button response and that measured in the AWAKE beamline is shown in Fig. 4. The simulated sensitivity was 6.2 %/mm compared to (6.3 ± 0.1) %/mm using the AWAKE electron beam.

In order to operate in the optimal working regime of 10's of GHz, a 21-40 GHz band pass filter, in series with a 40 GHz coaxial detector was introduced into the acquisition chain.

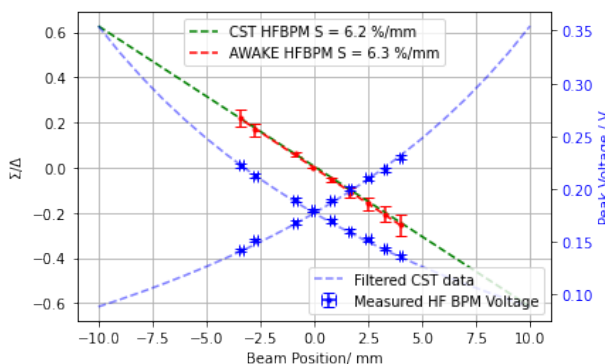

Figure 4: The comparison between the simulated and measured response of the HF Button as a function of the electron beam position. Both the raw voltage at the oscilloscope (blue) and the $\Delta U_x / \Sigma U_x$ values (red and green) are consistent between the experimental results and CST simulation assuming perfect symmetry of the horizontal pickups.

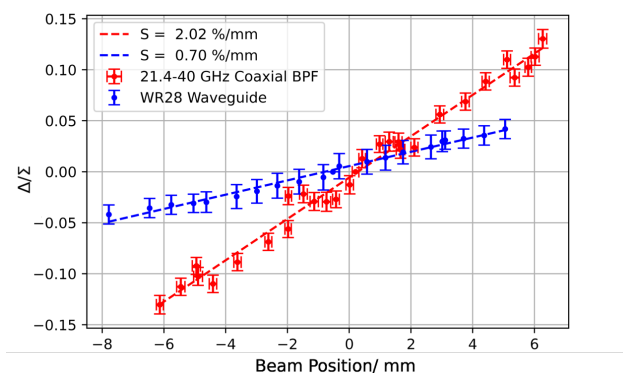

Figure 5: The sensitivities of the HF BPM with a coaxial acquisition, filtered with a 21.4-40 GHz BPF (red), and with a WR28 waveguide acquisition filtered additionally with a 30 GHz LPF (blue).

From Fig. 5, the filtered signal shows reduced sensitivity to the electron beam position by 1/3 at $(2.02 \pm 0.05) \% / mm$.

Integration into the front-end electronics developed by TRIUMF [6] and discussed in the complimentary paper [7], requires the transition from a coaxial acquisition to a waveguide system. This is done using a 281B coaxial-to-WG adapter and a flexible WR28 waveguide. A cutoff of 30 GHz is defined by a low-pass filter, and a zero bias Schottky diode detector rectifies the input signal, which is then transmitted through a coaxial line to the oscilloscope. Again, the sensitivity is seen to decrease with this new signal processing chain, to $0.70 \pm 0.03 \% / mm$. This decrease in sensitivity could be attributed to the non-linearity of the diode detectors, exacerbated at higher charges. A repeat of the scan at lower electron bunch charges could be useful to characterise the diodes in a linear regime.

Proton Beam Studies

In order to show that the HF BPM has good rejection of the proton signal, a dedicated proton study was performed using

the filtered coaxial setup at frequency range 21.6-40 GHz. There were two intensities of proton bunch over the run, with proton numbers of 1×10^{11} and 3×10^{11} per bunch. For each bunch population, a minimum of 2000 shots were recorded. Each proton bunch can be extracted from the SPS every 20-30 seconds. From each voltage signal recorded at the oscilloscope, the peak voltage was identified and deposited into a histogram in order to view the distribution of the proton contribution, presented in Fig. 6. To ensure that the voltage signal was only taken when a proton bunch was present, and not due to other effects such as magnetic fluctuations from the bunch extraction, the signal was triggered by a direct coaxial signal level of over 1 V, that could only arise from the presence of a long, high-charge proton bunch.

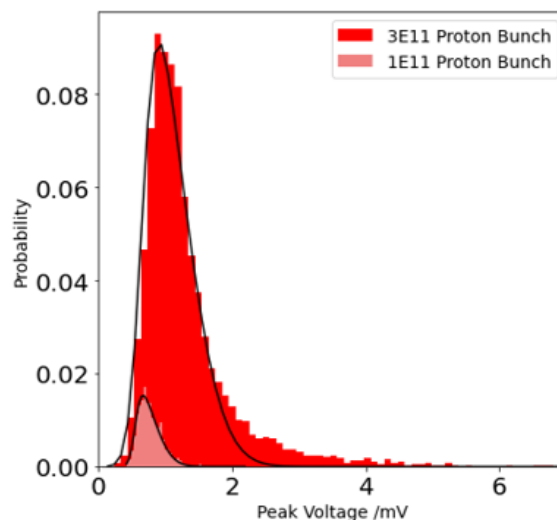

Figure 6: The distribution of the peak voltages recorded at the oscilloscope over a large number of proton shots represented with a histogram for low and high intensity proton bunches. Black curves represent a fitted probability density function to the distribution.

Even for the highest bunch intensities the proton signal has a small distribution with an average of 1.34 mV, FWHM 1.38 mV. When compared to the range of voltages recorded at the oscilloscope when electron bunches are present, the proton signal becomes negligible for low intensity protons, and up to 5% at high proton intensities at the 3σ limit.

Combined Beam Tests

With both the proton and electron beam present, for each beam position, 500 shots were taken with the oscilloscope, a long enough period for at least 3 proton shots to pass through the beamline. This was repeated for both low intensity (1×10^{11}) and high intensity (3×10^{11}) proton bunches. The signals containing the proton shots were then identified and separated from the electron shots, and the difference-over-sum calculation performed. For proton bunches of population 1×10^{11} , the position sensitivity is shown in Fig. 7.

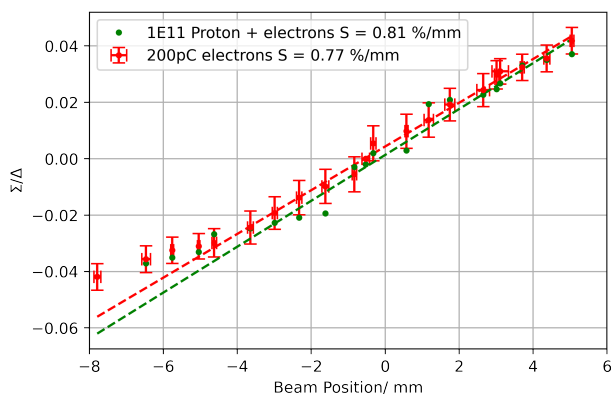

Figure 7: Position sensitivity of the HF BPM with 320 pC electrons only (red) and electrons and 1×10^{11} protons (green). The best fit is calculated between -5 and 5 mm.

The position sensitivity is consistent to within 3σ when the proton beam is present. This indicates that there is a negligible contribution of the proton signal using this configuration with low proton bunch populations, and the HF BPM can successfully discriminate the electron signal for beam position measurements.

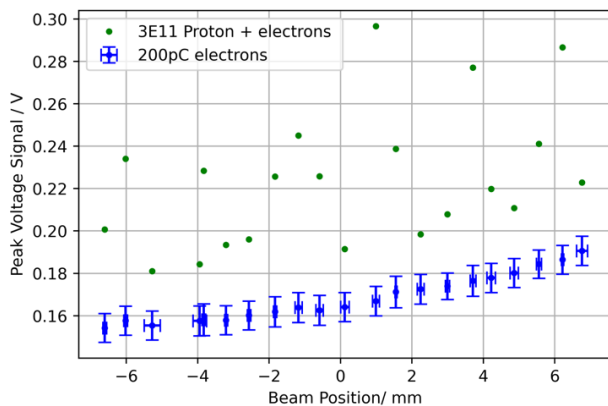

Figure 8: The peak voltage as a function of beam position with and without proton bunches present. The peak voltage increases at all beam positions and sensitivity to the electron position is lost.

The results from using high intensity proton bunches with bunch populations of 3×10^{11} is presented in Fig. 8. For the HF Button the voltage at the oscilloscope is greatly increased when the proton bunch is present, indicating that the BPM is no longer insensitive to the proton signal. There is little consistency between the increase in signal at each beam

position therefore the voltage becomes independent of the electron beam position in the beam pipe and a sensitivity measurement cannot be made. Additionally, at a few hundred mV, the saturation of the diodes becomes relevant, and the sensitivity may be arbitrarily decreased compared to a system without charge dependent detectors.

CONCLUSION

A high frequency button-type BPM has been investigated as a beam position monitor for the AWAKE electron beam in a frequency band up to 40 GHz. Studies with both proton and electron bunches reveal successful discrimination of the electron beam position in the presence of a proton bunch at low proton bunch intensities. However, the extensive frequency content of the high intensity proton bunches leads to significant contribution of the proton signal on top of the electron signal and breakdown of the electron position sensitivity with these beam parameters. Integration with a TRIUMF front-end at 40 GHz and subsequent beam tests are ongoing.

REFERENCES

- [1] E. Adli *et al.* (AWAKE Collaboration), “Experimental observation of proton bunch modulation in a plasma, at varying plasma densities,” *Phys. Rev. Lett.* vol. 122, p. 054802, 2019. doi:10.1103/PhysRevLett.122.054802
- [2] AWAKE Collaboration, “Acceleration of electrons in the plasma wakefield of a proton bunch,” *Nature*, vol. 561, pp. 363–367, 2018. doi:10.1038/s41586-018-0485-4
- [3] P. Muggli (AWAKE Collaboration), “Physics to plan AWAKE Run 2,” *J. Phys. Conf. Ser.*, vol. 1596, p. 012008, 2020. doi:10.1088/1742-6596/1596/1/012008
- [4] A.-M. Bachmann and P. Muggli, “Beam Diagnostics in the Advanced Plasma Wakefield Experiment AWAKE,” in *Proc. IBIC’20*, Santos, Brazil, Sep. 2020, pp. 1–6. doi:10.18429/JACoW-IBIC2020-MOA001
- [5] A. Angelovski *et al.*, “High bandwidth pickup design for bunch arrival-time monitors for free-electron laser,” *Phys. Rev. ST Accel. Beams*, vol. 15, p. 112803, 2012. doi:10.1103/PhysRevSTAB.15.112803
- [6] S. Liu *et al.*, “The Installation and Commissioning of the AWAKE Stripline BPM,” in *Proc. IBIC’18*, Shanghai, China, Sep. 2018, pp. 253–256. doi:10.18429/JACoW-IBIC2018-TUPB01
- [7] C. Pakuza *et al.*, “The study of high-frequency pick-ups for electron beam position measurements in the AWAKE common-beamline,” presented at IBIC’24, Beijing, China, Sep. 2024, paper TUDC2, this conference.