

Refno: PS/ML/Technical note/85-9

Author(s): Mats Möller

Subject: The pick-up electrode support in ACOL

## 1. SCOPE

The stochastic cooling pick-ups and kickers in the ACOL machine are supported by two 2.1 m long aluminium beams facing each other inside the vacuum tank. As the particle beam cools, its dimensions decrease, so the systems are mobile and they have to move in and out on each cycle. The structures have to be opened in a few hundred milliseconds at the end of the cooling process, to allow the next injected pulse to circulate. The pick-up electrodes and their supporting beam are kept at a temperature of less than 100 K.

The support beam is connected to two rigid shafts via a system of springs, see Figure 1.

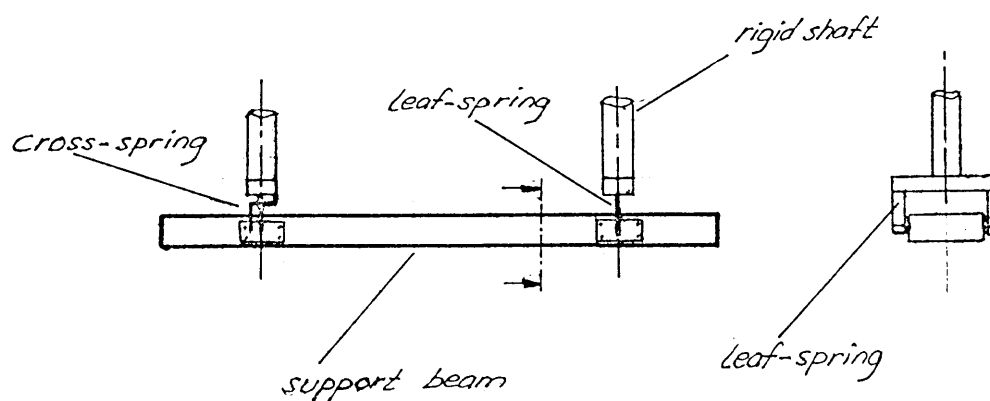

Figure 1: The electrode support beam

A cross-spring has to be used in one end, to give the beam a sufficiently stiff connection in longitudinal direction.

This means that the leaf-spring at the other end has to take the whole thermal shrinkage of the beam. It also has to take acceleration- and gravity-forces.

This leaf-spring must be considered as the most critical part in the connection beam-shaft, and a detailed study of the stresses has been performed with the finite element method (SAPV).

## 2. LOADS

The spring must be able to withstand the following loads:

1. The cooling down from room-temperature to 80 K causes a considerable shrinking of the aluminium beam. This shrinking has to be taken by the leaf-spring.
2. Accelerations during ordinary working conditions ( [1] ):  
1.0 g for  $10^8$  cycles
3. Accelerations during limit working conditions ( [1] ):  
3.0 g for  $10^8$  cycles
4. Accelerations during error conditions ( [1] ):  
10.0 g
5. Angular rotation during working conditions ( [2] ):  
 $\pm 0.53^\circ$  for  $10^8$  cycles
6. Angular rotation during error conditions ( [2] ):  
 $\pm 2.95^\circ$
7. Gravity forces

### 3. MATERIAL DATAS

Aluminium beam:

Thermal expansion  $\alpha = -385 \cdot 10^{-5}$  mm/mm ( [3] p 95)

Leaf spring:

Titanium 6Al-4V ELI, annealed

	293 K	100 K	Reference
Yield strength $\sigma_{0,2}$ (N/mm <sup>2</sup> )	820	1172	[3] p 679
Tensile strength $\sigma_b$ (N/mm <sup>2</sup> )	841	1296	[3] p 685
Fatigue strength $\sigma_u$ (N/mm <sup>2</sup> )	283	503	[3] p 718
Modulus of elasticity E (N/mm <sup>2</sup> )	115000	127000	[3] p 713
Poisson's ratio $\nu$	0.32	0.30	[3] p 724

#### 4. DESIGN CRITERIA

The springs must be designed to fulfill the following points:

1. The maximum stress  $\sigma_{\max}$ , occurred during error conditions must be less than, or equal to 2/3 of the yield stress:

$$\sigma_{\max} \leq 2/3 \cdot \sigma_{0,2}$$

2. The spring must be able to sustain at least  $10^8$  cycles of the acceleration forces during limit working conditions (3.0 g) together with thermal and gravity forces.
3. There must be no damage during error conditions. Meaning that failure through instability must be prevented.

## 5. CALCULATED CONFIGURATIONS

In order to get a good view of the stresses and in order to choose the optimal design, the analyses are made for different thicknesses and lengths of the spring.

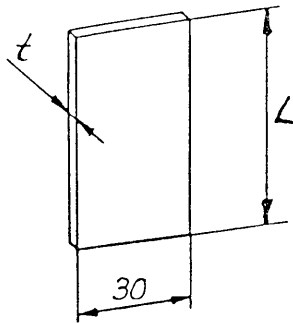

$$t = 0,1 - 2,0 \text{ mm , step } 0,1$$

$$L = 40 - 80 \text{ mm , step } 10$$

The beam can be in three different positions:

### 1. Vertical upper

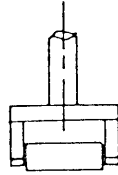

### 2. Horizontal

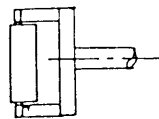

### 3. Vertical lower

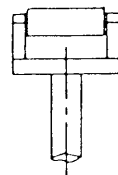

The worst case from stress point of view is case 2.

Total mass of the aluminium beam: 30 kg.

---

## 6. STRESS CALCULATION

### 6.1 Forces

The forces acting on the spring can be divided into the following:

#### STATIC

- A: Force from transverse thermal shrinking of the aluminium beam.
- B: Gravity force when mounted horizontal.
- C: Force from longitudinal thermal shrinking of the aluminium beam.

#### DYNAMIC

- D: Angular rotation of the spring.
- E: Forces caused by the acceleration during working.

### 6.2 Stresses

The stresses caused by the forces in 6.1 are added as follow:

- For the maximum stress during error conditions

$$\sigma_{\max} = \sigma_A + \sigma_B + \sigma_C + \sigma_D + \sigma_E$$

- For the stresses during limit working conditions:

mean stress  $\sigma_m = \sigma_A + \sigma_B + \sigma_C$

alternating stress  $\sigma_a = \sigma_D + \sigma_E$

$$\sigma = \sigma_m \pm \sigma_a$$

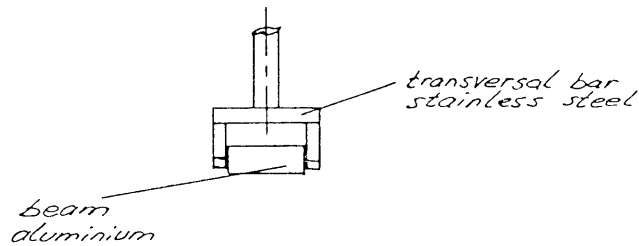
6.2.1 Stress from transverse shrinking,  $\sigma_A$ 

The difference in elongation between the transversal bar in stainless steel and the aluminium beam during cool-down is taken up by a spring. This causes a reaction force on the leaf-spring. This force is calculated to be 160 N.

The stress in the leaf-spring is then:

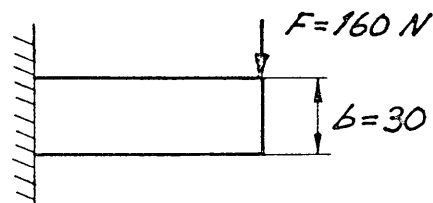

$$\sigma_A = M/W = F \cdot L \cdot 6 / (t \cdot b^2)$$

6.2.2 Stress from gravity forces,  $\sigma_B$ 

One spring is supporting half the mass of the beam:

$$F = 300/2 = 150 \text{ N}$$

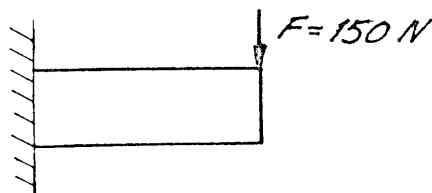

$$\sigma_B = M/W = F \cdot L \cdot 6 / (t \cdot b^2)$$



### 6.2.3 Stress from longitudinal shrinking, $\sigma_C$

The longitudinal shrinking  $\Delta L$  of the aluminium beam is:

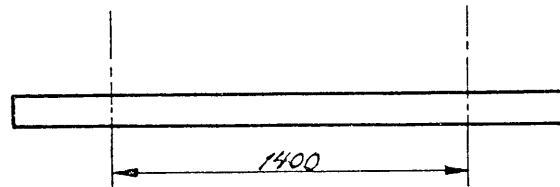

$$\Delta L = -385 \cdot 10^{-5} \cdot 1400 = -5.4 \text{ mm}$$

This deflection has to be taken by the leaf-spring. But in order to reduce the stresses, it is possible to elastically predeflect the spring when the system is assembled in room-temperature.

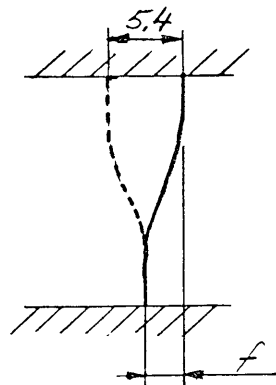

The maximum stress  $\sigma_C$  in the spring is calculated for the following values of  $f$ :

$f$ (mm)	
5.4	no predeflection
4.4	1.0 mm predefl
2.7	2.7 mm predefl

### 6.2.4 Stress from angular rotation, $\sigma_D$

The angular rotations mentioned in 2., gives a stress  $\sigma_D$  which is calculated for the two cases.

$$3.0 \text{ g case : } \alpha = \pm 0.53^\circ$$

$$10.0 \text{ g case : } \alpha = \pm 2.95^\circ$$

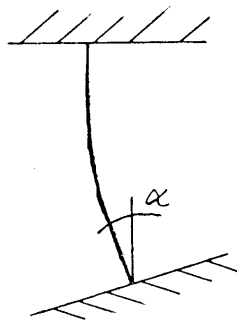

### 6.2.5 Stresses from the acceleration, $\sigma_E$

The accelerations in longitudinal direction causes stresses in the allready deformed spring.

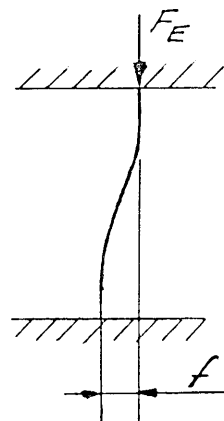

Each spring is taking  
1/4 of the total mass.

$$3.0 \text{ g case: } F_E = 3.0 \cdot 10 \cdot 30 / 4 = 225 \text{ N}$$

$$10.0 \text{ g case: } F_E = 10.0 \cdot 10 \cdot 30 / 4 = 750 \text{ N}$$

### 6.3 Calculated stresses

#### 6.3.1 Stresses at 10.0 g

The maximum stress  $\sigma_{\max}$  is plotted in page 12-14. Appendix A shows the stresses in detail, with each component  $\sigma_A$ - $\sigma_E$  printed.

#### 6.3.2 Stresses at 3.0 g

The stress  $\sigma = \sigma_m \pm \sigma_a$  is plotted for some of the configurations in page 15-17. The stresses are shown in fatigue-diagrams (Smith) with  $\sigma_m$  on the horizontal axis and  $\sigma$  on the vertical.

The stresses are presented in detail in appendix B.

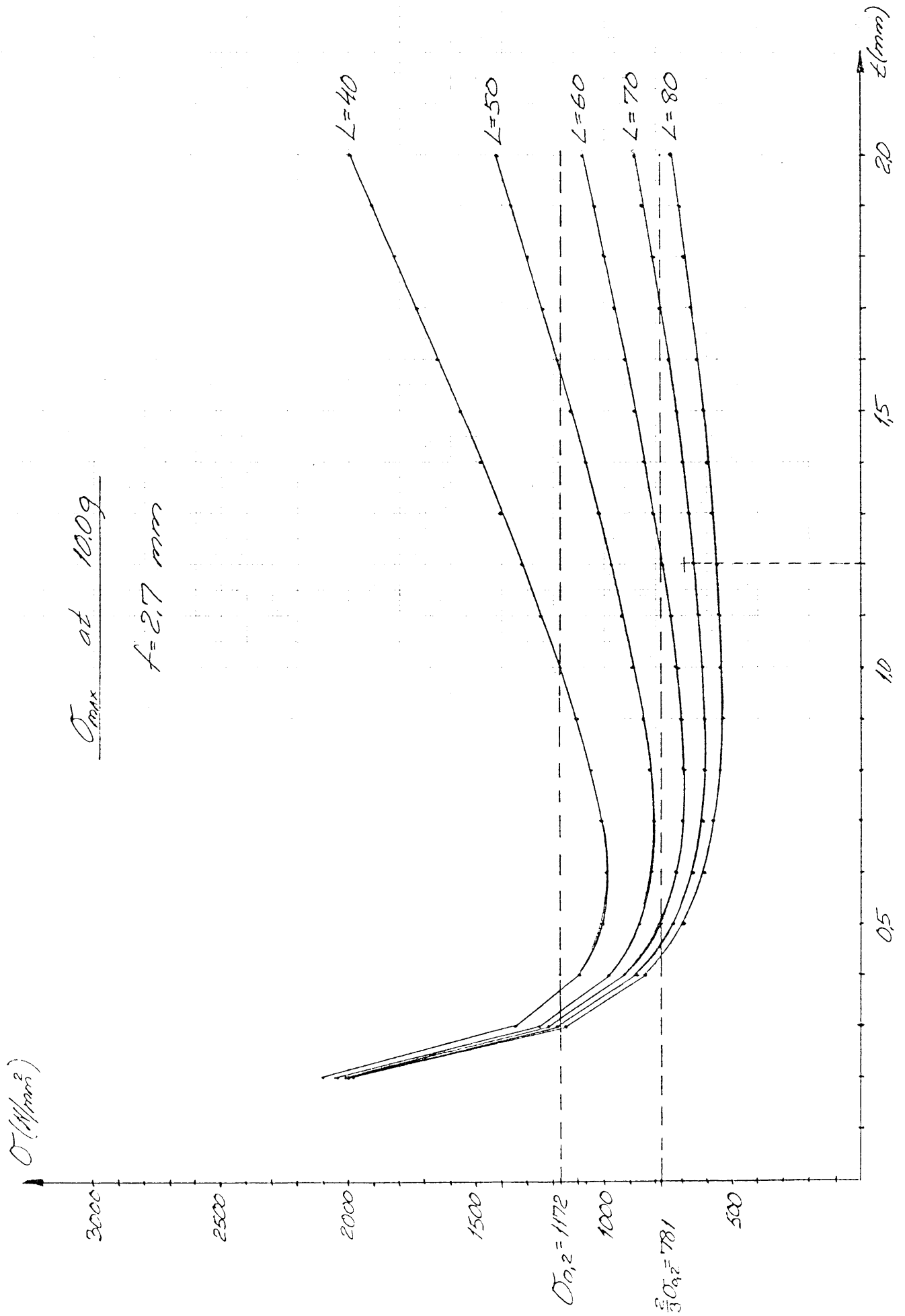

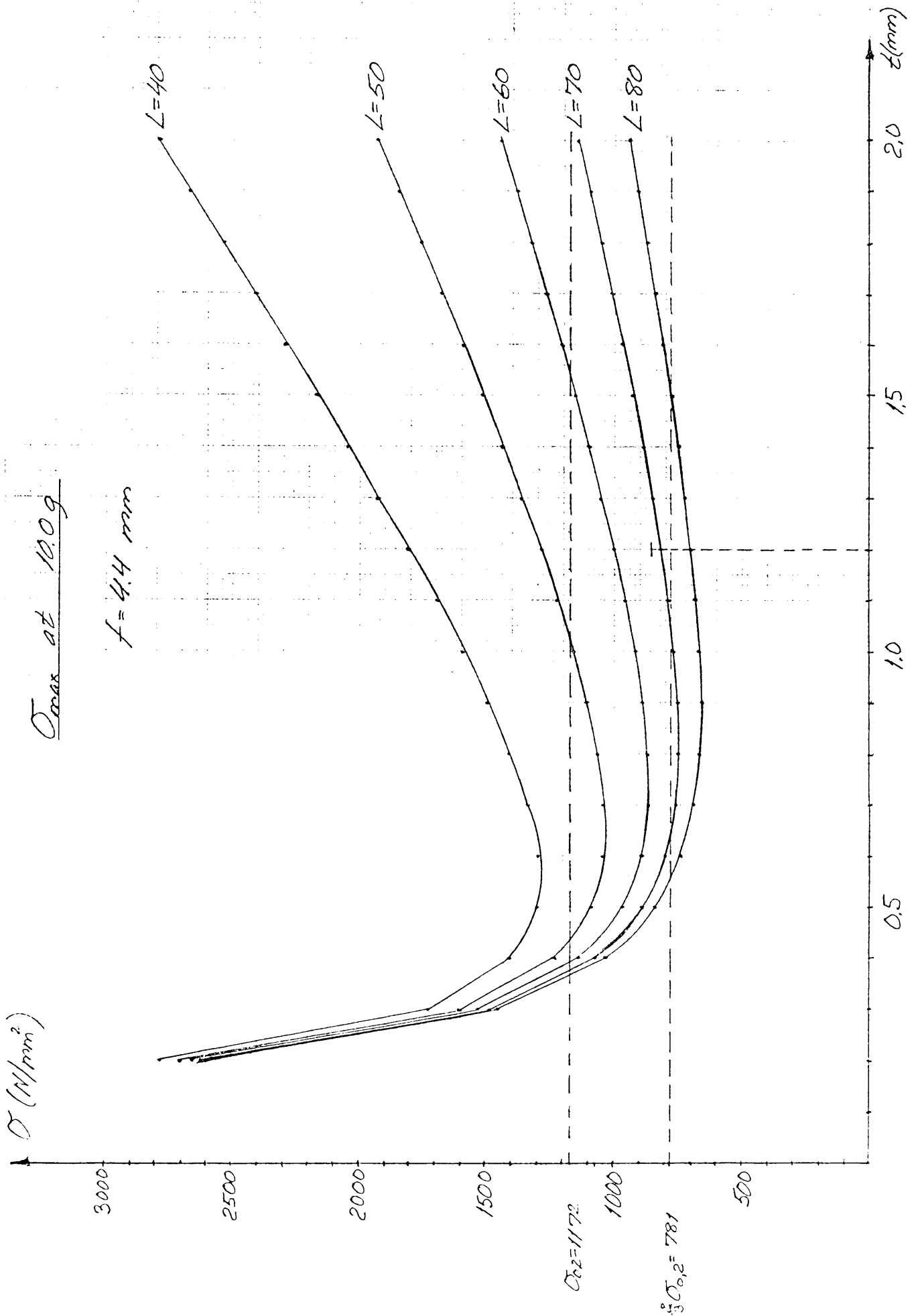

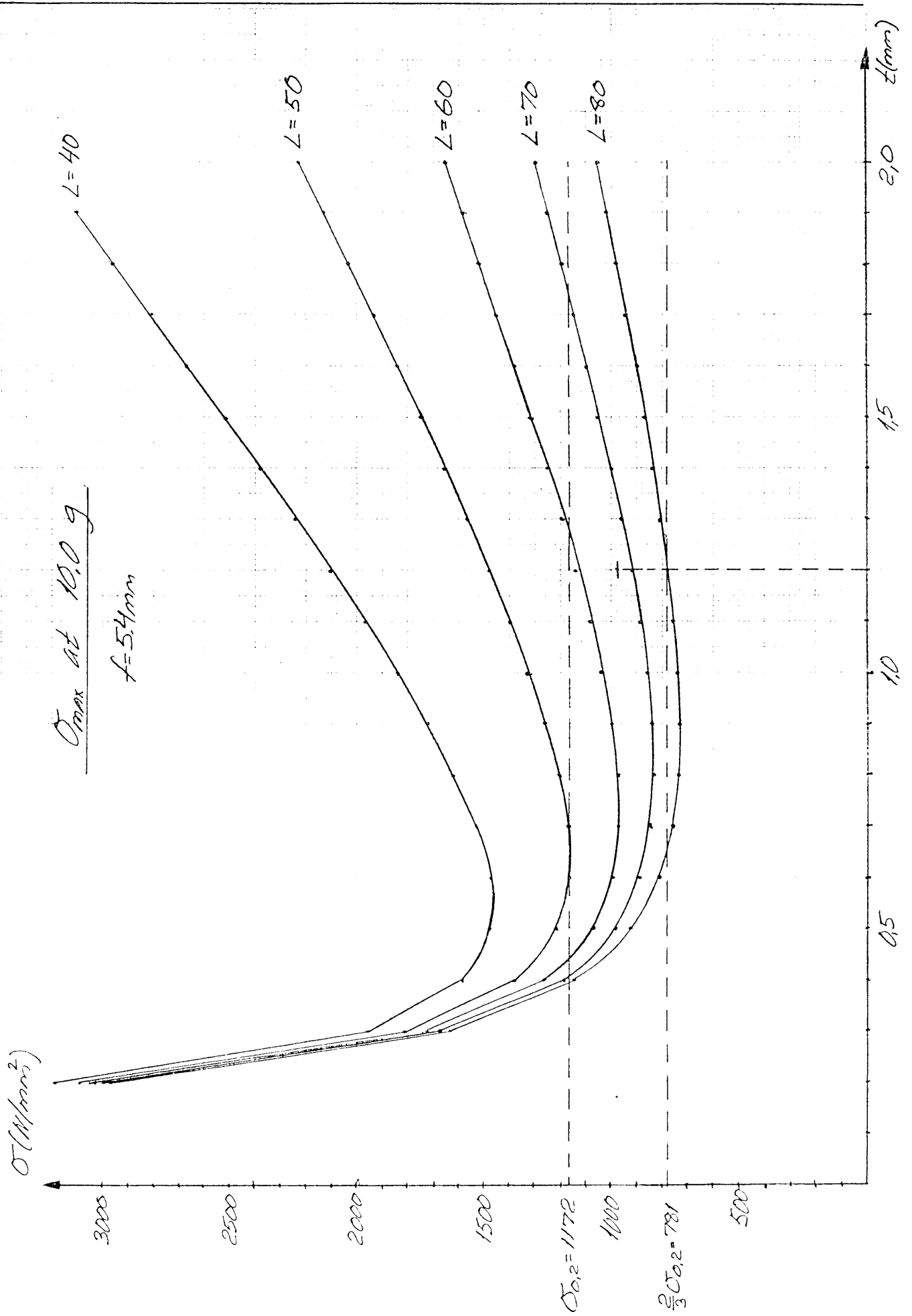

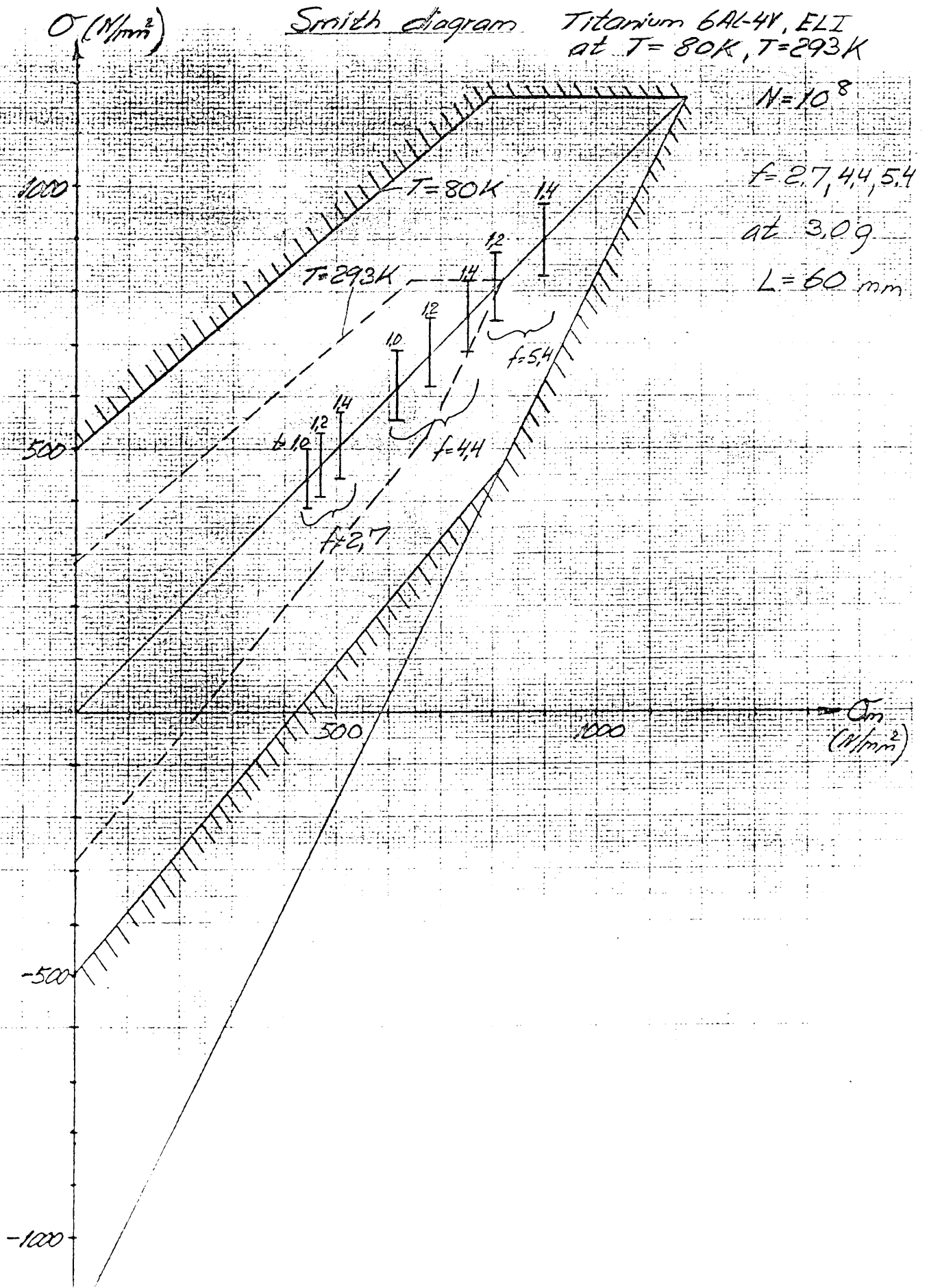

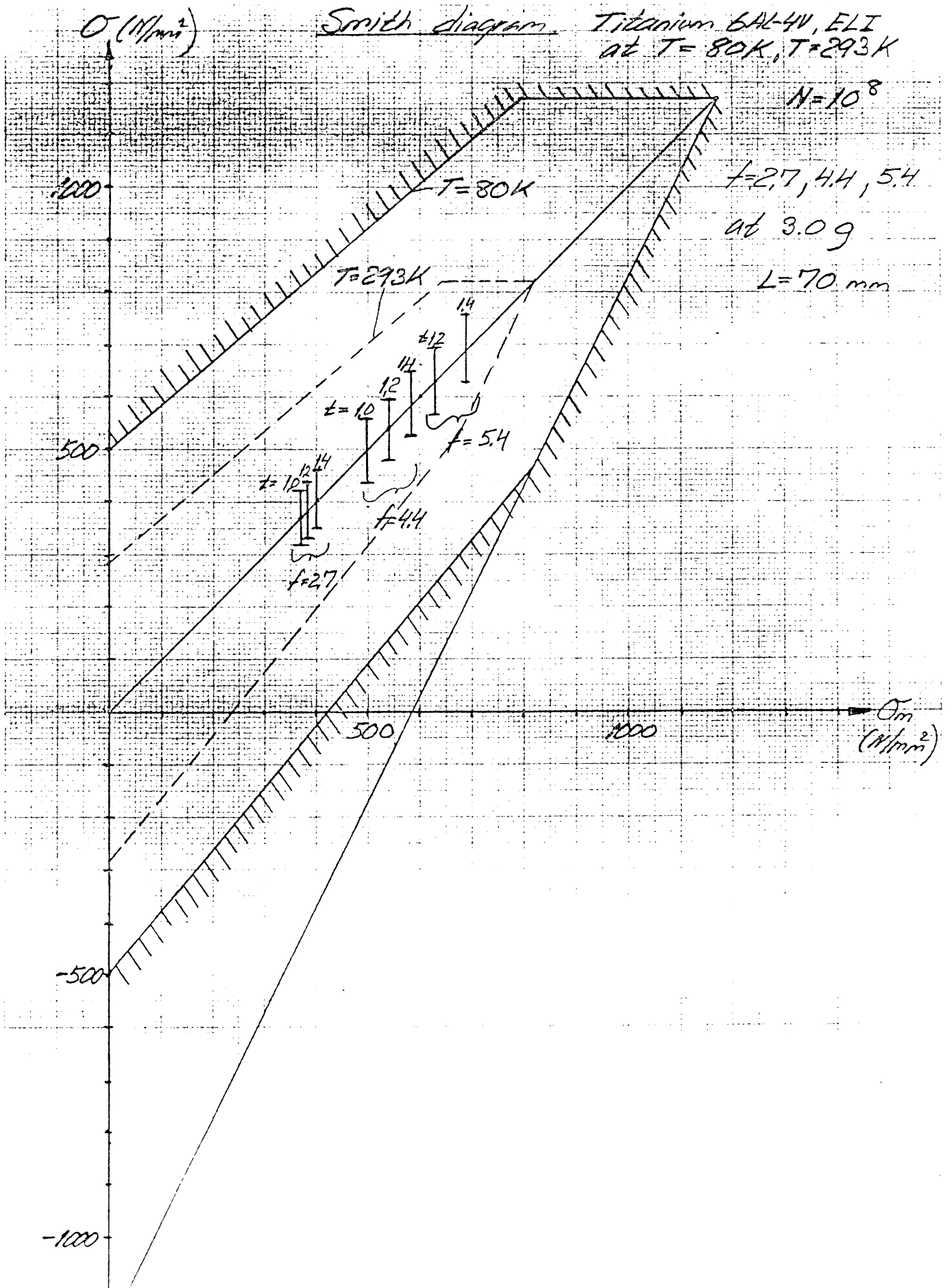



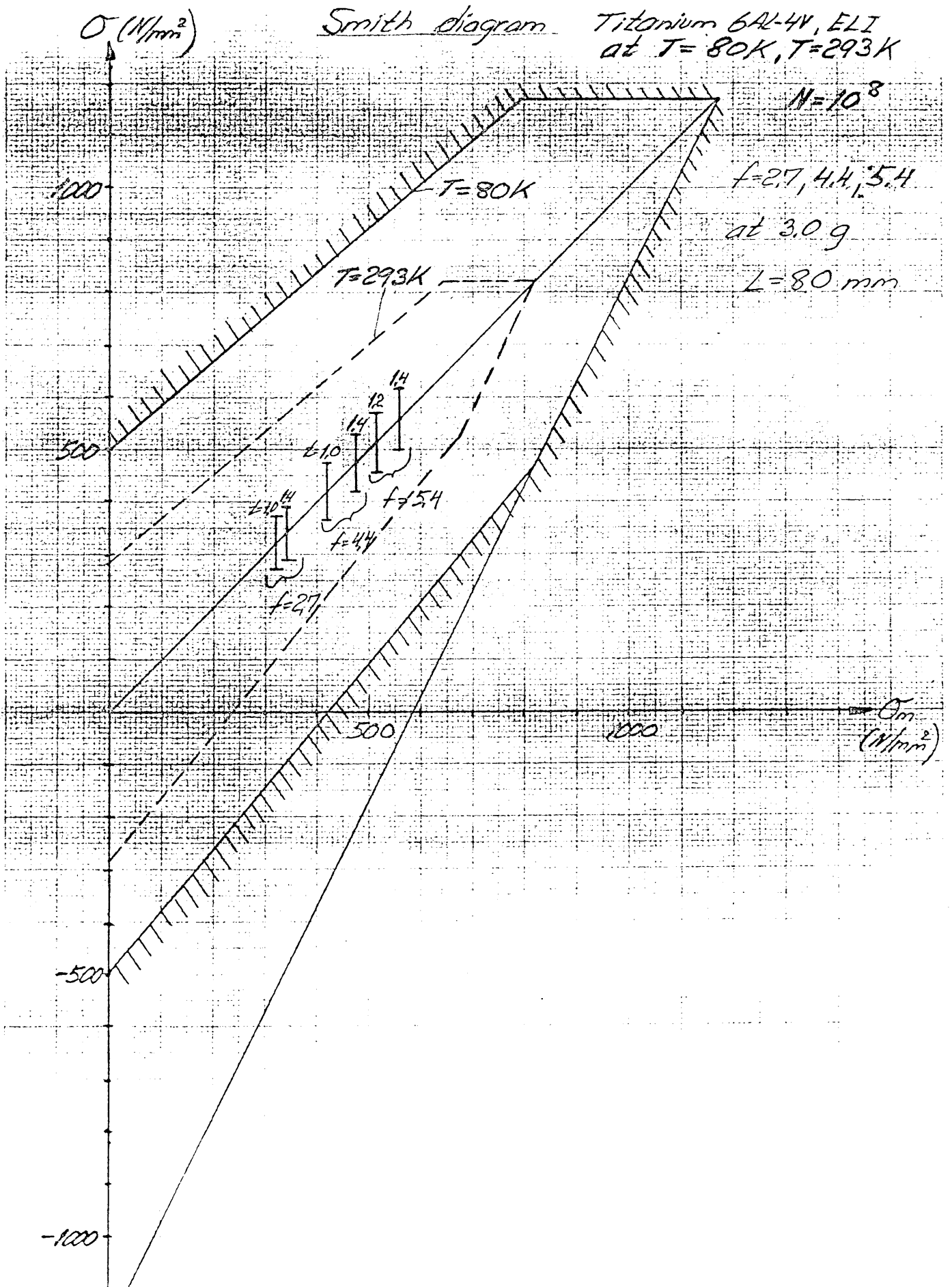

## 7. STABILITY

The critical buckling load has been calculated for the predeformed spring. The program is only capable of calculating linear buckling, and this is a more or less non-linear case (because of the predeformation). To take this into account is the upper end of the spring hinged instead of clamped.

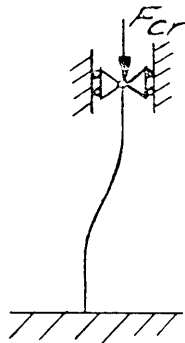

If we then use a factor of safety FS equal to 3, we will have:

Max force per spring:

$$F_a = 30/4 \cdot 10 \cdot 0.3 = 2250 \text{ N}$$

We can now directly get the needed thickness that corresponds to a certain length, from the diagram on next page.

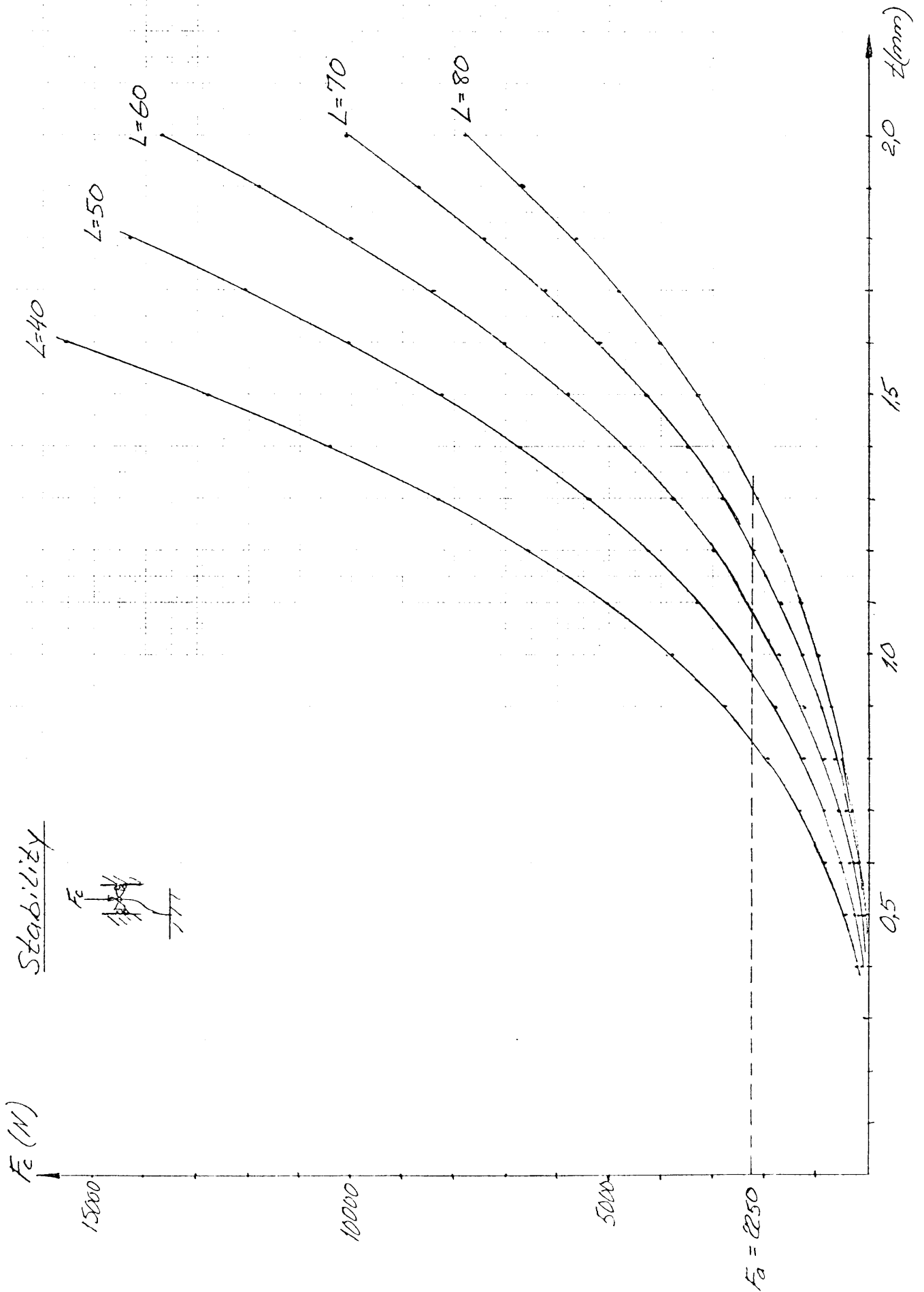

## 8. CONCLUSIONS

From the max-stress diagrams (p. 12-14) we can see that the spring ought to be as long as possible, in order to reduce the stresses. The longest it can be, due to problems with space, is 68 mm. From the stability diagram (p. 19) we can obtain the needed thickness  $t$ .

$$L = 68 \text{ mm} \Rightarrow t = 1.2 \text{ mm}$$

This gives a slenderness ratio  $\lambda$ :

$$\lambda = l_f / r_i$$

$$l_f = 0.7 \cdot L = 0.7 \cdot 68 = 47.6 \text{ mm}$$

$$r_i = \sqrt{I/A} = t \cdot \sqrt{1/12} = 0.346$$

$$\lambda = 47.6 / 0.346 = 137.6 < 200 \text{ OK!}$$

In order to not exceed the allowed max-stress of  $2/3 \cdot \sigma_{02} = 781 \text{ N/mm}^2$  (at 100 K), it is necessary to predeform the spring. The stress diagrams shows that  $f$  should be somewhere between 2.7 and 4.4 mm.

A detailed calculation gives that a predeformation of 2 mm ( $f=3.4 \text{ mm}$ ) corresponds to a max-stress of  $760 \text{ N/mm}^2$ . If we look at the fatigue diagrams, we can see that the margin to failure due to fatigue will be sufficiently large.

To create the predeflection we need a force  $F$  and a moment  $M$ :

$$F = 41 \text{ N}$$

$$M = 1390 \text{ Nmm}$$

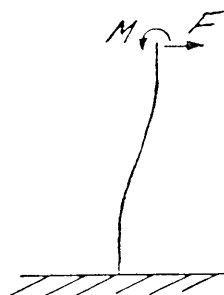

## Summary:

Choose a spring with

$$L = 68 \text{ mm}$$

$$t = 1.2 \text{ mm}$$

$$b = 30 \text{ mm}$$

predeflection: 2.0 mm

$$\text{Max stress } \sigma_{\max} = 760 \text{ N/mm}^2 \quad (10.0 \text{ g})$$

$$\text{Working stress } \sigma = 503 \pm 55 \text{ N/mm}^2 \quad (3.0 \text{ g})$$

## REFERENCES

- [1] T.T. Nielsen:  
Design specifications for the mechanical system for the stochastic cooling on ACOL.  
7-6-1985.
- [2] C. Brade:  
Positions of pick-ups and kickers. Angles and distances to beam-center.  
18-6-1985.
- [3] Fred R. Schwarzberg:  
Cryogenic materials data handbook, volume I.  
July 1970.

APPENDIX A

STRESSES AT 10.0 G.

STRESSES AT 10.0 g

Deflection f = 2.7 mm

Length = 40. mm

t (mm)	A (N/mm <sup>2</sup> )	B (N/mm <sup>2</sup> )	C (N/mm <sup>2</sup> )	D (N/mm <sup>2</sup> )	E (N/mm <sup>2</sup> )	Sigmax (N/mm <sup>2</sup> )
0.1	853.3	800.0	62.7	31.9	4087.0	5835.0
0.2	426.7	400.0	125.5	63.8	1084.2	2100.2
0.3	284.4	266.7	188.2	95.7	509.7	1344.7
0.4	213.3	200.0	250.9	127.6	302.3	1094.2
0.5	170.7	160.0	313.6	159.5	203.5	1007.3
0.6	142.2	133.3	376.4	191.4	148.2	991.6
0.7	121.9	114.3	439.1	223.3	114.0	1012.7
0.8	106.7	100.0	501.8	255.3	91.2	1055.0
0.9	94.8	88.9	564.6	287.2	75.1	1110.6
1.0	85.3	80.0	627.3	319.1	63.4	1175.1
1.1	77.6	72.7	690.0	351.0	54.4	1245.7
1.2	71.1	66.7	752.8	382.9	47.5	1320.9
1.3	65.6	61.5	815.5	414.8	41.9	1399.4
1.4	61.0	57.1	878.2	446.7	37.4	1480.4
1.5	56.9	53.3	940.9	478.6	33.7	1563.5
1.6	53.3	50.0	1003.7	510.5	30.6	1648.1
1.7	50.2	47.1	1066.4	542.4	28.0	1734.1
1.8	47.4	44.4	1129.1	574.3	25.7	1821.0
1.9	44.9	42.1	1191.9	606.2	23.8	1908.9
2.0	42.7	40.0	1254.6	638.1	22.1	1997.5

STRESSES AT 10.0 g

Deflection f = 2.7 mm

Length = 50. mm

t (mm)	A (N/mm <sup>2</sup> )	B (N/mm <sup>2</sup> )	C (N/mm <sup>2</sup> )	D (N/mm <sup>2</sup> )	E (N/mm <sup>2</sup> )	Sigmax (N/mm <sup>2</sup> )
0.1	853.3	800.0	40.1	25.5	4087.0	5806.0
0.2	426.7	400.0	80.3	51.1	1084.2	2042.3
0.3	284.4	266.7	120.4	76.6	509.7	1257.8
0.4	213.3	200.0	160.6	102.1	302.3	978.3
0.5	170.7	160.0	200.7	127.6	203.5	862.5
0.6	142.2	133.3	240.9	153.2	148.2	817.8
0.7	121.9	114.3	281.0	178.7	114.0	809.9
0.8	106.7	100.0	321.2	204.2	91.2	823.2
0.9	94.8	88.9	361.3	229.7	75.1	849.9
1.0	85.3	80.0	401.5	255.3	63.4	885.4
1.1	77.6	72.7	441.6	280.8	54.4	927.1
1.2	71.1	66.7	481.8	306.3	47.5	973.3
1.3	65.6	61.5	521.9	331.8	41.9	1022.9
1.4	61.0	57.1	562.1	357.4	37.4	1074.9
1.5	56.9	53.3	602.2	382.9	33.7	1129.0
1.6	53.3	50.0	642.4	408.4	30.6	1184.7
1.7	50.2	47.1	682.5	433.9	28.0	1241.7
1.8	47.4	44.4	722.6	459.5	25.7	1299.7
1.9	44.9	42.1	762.8	485.0	23.8	1358.6
2.0	42.7	40.0	802.9	510.5	22.1	1418.2



STRESSES AT 10.0 g

Deflection f = 2.7 mm

Length = 60. mm

t (mm)	A (N/mm <sup>2</sup> )	B (N/mm <sup>2</sup> )	C (N/mm <sup>2</sup> )	D (N/mm <sup>2</sup> )	E (N/mm <sup>2</sup> )	Sigmax (N/mm <sup>2</sup> )
0.1	853.3	800.0	27.9	21.3	4087.0	5789.5
0.2	426.7	400.0	55.8	42.5	1084.2	2009.2
0.3	284.4	266.7	83.6	63.8	509.7	1208.2
0.4	213.3	200.0	111.5	85.1	302.3	912.2
0.5	170.7	160.0	139.4	106.4	203.5	779.9
0.6	142.2	133.3	167.3	127.6	148.2	718.7
0.7	121.9	114.3	195.2	148.9	114.0	694.3
0.8	106.7	100.0	223.0	170.2	91.2	691.1
0.9	94.8	88.9	250.9	191.4	75.1	701.2
1.0	85.3	80.0	278.8	212.7	63.4	720.2
1.1	77.6	72.7	306.7	234.0	54.4	745.4
1.2	71.1	66.7	334.6	255.3	47.5	775.1
1.3	65.6	61.5	362.4	276.5	41.9	808.1
1.4	61.0	57.1	390.3	297.8	37.4	843.6
1.5	56.9	53.3	418.2	319.1	33.7	881.2
1.6	53.3	50.0	446.1	340.3	30.6	920.4
1.7	50.2	47.1	474.0	361.6	28.0	960.8
1.8	47.4	44.4	501.8	382.9	25.7	1002.3
1.9	44.9	42.1	529.7	404.1	23.8	1044.7
2.0	42.7	40.0	557.6	425.4	22.1	1087.8

STRESSES AT 10.0 g

Deflection f = 2.7 mm

Length = 70. mm

t (mm)	A (N/mm <sup>2</sup> )	B (N/mm <sup>2</sup> )	C (N/mm <sup>2</sup> )	D (N/mm <sup>2</sup> )	E (N/mm <sup>2</sup> )	Sigmax (N/mm <sup>2</sup> )
0.1	853.3	800.0	20.5	18.2	4087.0	5779.0
0.2	426.7	400.0	41.0	36.5	1084.2	1988.3
0.3	284.4	266.7	61.4	54.7	509.7	1176.9
0.4	213.3	200.0	81.9	72.9	302.3	870.5
0.5	170.7	160.0	102.4	91.2	203.5	727.7
0.6	142.2	133.3	122.9	109.4	148.2	656.1
0.7	121.9	114.3	143.4	127.6	114.0	621.2
0.8	106.7	100.0	163.9	145.9	91.2	607.6
0.9	94.8	88.9	184.3	164.1	75.1	607.3
1.0	85.3	80.0	204.8	182.3	63.4	615.9
1.1	77.6	72.7	225.3	200.6	54.4	630.6
1.2	71.1	66.7	245.8	218.8	47.5	649.8
1.3	65.6	61.5	266.3	237.0	41.9	672.4
1.4	61.0	57.1	286.8	255.3	37.4	697.5
1.5	56.9	53.3	307.2	273.5	33.7	724.7
1.6	53.3	50.0	327.7	291.7	30.6	753.4
1.7	50.2	47.1	348.2	309.9	28.0	783.4
1.8	47.4	44.4	368.7	328.2	25.7	814.5
1.9	44.9	42.1	389.2	346.4	23.8	846.4
2.0	42.7	40.0	409.7	364.6	22.1	879.1

STRESSES AT 10.0 g

Deflection f = 2.7 mm

Length = 80. mm

t (mm)	A (N/mm <sup>2</sup> )	B (N/mm <sup>2</sup> )	C (N/mm <sup>2</sup> )	D (N/mm <sup>2</sup> )	E (N/mm <sup>2</sup> )	Sigmax (N/mm <sup>2</sup> )
0.1	853.3	800.0	15.7	16.0	4087.0	5772.0
0.2	426.7	400.0	31.4	31.9	1084.2	1974.2
0.3	284.4	266.7	47.0	47.9	509.7	1155.7
0.4	213.3	200.0	62.7	63.8	302.3	842.2
0.5	170.7	160.0	78.4	79.8	203.5	692.3
0.6	142.2	133.3	94.1	95.7	148.2	613.6
0.7	121.9	114.3	109.8	111.7	114.0	571.7
0.8	106.7	100.0	125.5	127.6	91.2	551.0
0.9	94.8	88.9	141.1	143.6	75.1	543.6
1.0	85.3	80.0	156.8	159.5	63.4	545.1
1.1	77.6	72.7	172.5	175.5	54.4	552.7
1.2	71.1	66.7	188.2	191.4	47.5	564.9
1.3	65.6	61.5	203.9	207.4	41.9	580.4
1.4	61.0	57.1	219.6	223.3	37.4	598.4
1.5	56.9	53.3	235.2	239.3	33.7	618.5
1.6	53.3	50.0	250.9	255.3	30.6	640.1
1.7	50.2	47.1	266.6	271.2	28.0	663.0
1.8	47.4	44.4	282.3	287.2	25.7	687.0
1.9	44.9	42.1	298.0	303.1	23.8	711.9
2.0	42.7	40.0	313.6	319.1	22.1	737.5

STRESSES AT 10.0 g

Deflection f = 4.4 mm

Length = 40. mm

t (mm)	A (N/mm <sup>2</sup> )	B (N/mm <sup>2</sup> )	C (N/mm <sup>2</sup> )	D (N/mm <sup>2</sup> )	E (N/mm <sup>2</sup> )	Sigmax (N/mm <sup>2</sup> )
0.1	853.3	800.0	102.2	31.9	6509.5	8296.9
0.2	426.7	400.0	204.4	63.8	1689.9	2784.8
0.3	284.4	266.7	306.7	95.7	778.8	1732.3
0.4	213.3	200.0	408.9	127.6	453.7	1403.5
0.5	170.7	160.0	511.1	159.5	300.4	1301.7
0.6	142.2	133.3	613.3	191.4	215.5	1295.8
0.7	121.9	114.3	715.5	223.3	163.5	1338.5
0.8	106.7	100.0	817.7	255.3	129.1	1408.7
0.9	94.8	88.9	920.0	287.2	105.1	1495.9
1.0	85.3	80.0	1022.2	319.1	87.6	1594.2
1.1	77.6	72.7	1124.4	351.0	74.5	1700.1
1.2	71.1	66.7	1226.6	382.9	64.3	1811.6
1.3	65.6	61.5	1328.8	414.8	56.3	1927.1
1.4	61.0	57.1	1431.0	446.7	49.8	2045.6
1.5	56.9	53.3	1533.3	478.6	44.5	2166.6
1.6	53.3	50.0	1635.5	510.5	40.1	2289.4
1.7	50.2	47.1	1737.7	542.4	36.4	2413.7
1.8	47.4	44.4	1839.9	574.3	33.2	2539.3
1.9	44.9	42.1	1942.1	606.2	30.5	2665.9
2.0	42.7	40.0	2044.3	638.1	28.1	2793.3

STRESSES AT 10.0 g

Deflection f = 4.4 mm

Length = 50. mm

t (mm)	A (N/mm <sup>2</sup> )	B (N/mm <sup>2</sup> )	C (N/mm <sup>2</sup> )	D (N/mm <sup>2</sup> )	E (N/mm <sup>2</sup> )	Sigmax (N/mm <sup>2</sup> )
0.1	853.3	800.0	65.4	25.5	6509.5	8253.8
0.2	426.7	400.0	130.8	51.1	1689.9	2698.4
0.3	284.4	266.7	196.3	76.6	778.8	1602.8
0.4	213.3	200.0	261.7	102.1	453.7	1230.8
0.5	170.7	160.0	327.1	127.6	300.4	1085.8
0.6	142.2	133.3	392.5	153.2	215.5	1036.8
0.7	121.9	114.3	457.9	178.7	163.5	1036.3
0.8	106.7	100.0	523.4	204.2	129.1	1063.3
0.9	94.8	88.9	588.8	229.7	105.1	1107.3
1.0	85.3	80.0	654.2	255.3	87.6	1162.4
1.1	77.6	72.7	719.6	280.8	74.5	1225.1
1.2	71.1	66.7	785.0	306.3	64.3	1293.4
1.3	65.6	61.5	850.4	331.8	56.3	1365.7
1.4	61.0	57.1	915.9	357.4	49.8	1441.1
1.5	56.9	53.3	981.3	382.9	44.5	1518.9
1.6	53.3	50.0	1046.7	408.4	40.1	1598.5
1.7	50.2	47.1	1112.1	433.9	36.4	1679.7
1.8	47.4	44.4	1177.5	459.5	33.2	1762.1
1.9	44.9	42.1	1243.0	485.0	30.5	1845.5
2.0	42.7	40.0	1308.4	510.5	28.1	1929.7

STRESSES AT 10.0 g

Deflection f = 4.4 mm

Length = 60. mm

t (mm)	A (N/mm <sup>2</sup> )	B (N/mm <sup>2</sup> )	C (N/mm <sup>2</sup> )	D (N/mm <sup>2</sup> )	E (N/mm <sup>2</sup> )	Sigmax (N/mm <sup>2</sup> )
0.1	853.3	800.0	45.4	21.3	6509.5	8229.5
0.2	426.7	400.0	90.9	42.5	1689.9	2649.9
0.3	284.4	266.7	136.3	63.8	778.8	1530.0
0.4	213.3	200.0	181.7	85.1	453.7	1133.9
0.5	170.7	160.0	227.2	106.4	300.4	964.6
0.6	142.2	133.3	272.6	127.6	215.5	891.3
0.7	121.9	114.3	318.0	148.9	163.5	866.6
0.8	106.7	100.0	363.4	170.2	129.1	869.3
0.9	94.8	88.9	408.9	191.4	105.1	889.1
1.0	85.3	80.0	454.3	212.7	87.6	919.9
1.1	77.6	72.7	499.7	234.0	74.5	958.5
1.2	71.1	66.7	545.2	255.3	64.3	1002.5
1.3	65.6	61.5	590.6	276.5	56.3	1050.6
1.4	61.0	57.1	636.0	297.8	49.8	1101.7
1.5	56.9	53.3	681.4	319.1	44.5	1155.2
1.6	53.3	50.0	726.9	340.3	40.1	1210.6
1.7	50.2	47.1	772.3	361.6	36.4	1267.5
1.8	47.4	44.4	817.7	382.9	33.2	1325.7
1.9	44.9	42.1	863.2	404.1	30.5	1384.8
2.0	42.7	40.0	908.6	425.4	28.1	1444.8

STRESSES AT 10.0 g

Deflection f = 4.4 mm

Length = 70. mm

t (mm)	A (N/mm <sup>2</sup> )	B (N/mm <sup>2</sup> )	C (N/mm <sup>2</sup> )	D (N/mm <sup>2</sup> )	E (N/mm <sup>2</sup> )	Sigmax (N/mm <sup>2</sup> )
0.1	853.3	800.0	33.4	18.2	6509.5	8214.4
0.2	426.7	400.0	66.8	36.5	1689.9	2619.8
0.3	284.4	266.7	100.1	54.7	778.8	1484.8
0.4	213.3	200.0	133.5	72.9	453.7	1073.5
0.5	170.7	160.0	166.9	91.2	300.4	889.1
0.6	142.2	133.3	200.3	109.4	215.5	800.8
0.7	121.9	114.3	233.6	127.6	163.5	760.9
0.8	106.7	100.0	267.0	145.9	129.1	748.6
0.9	94.8	88.9	300.4	164.1	105.1	753.2
1.0	85.3	80.0	333.8	182.3	87.6	769.0
1.1	77.6	72.7	367.1	200.6	74.5	792.5
1.2	71.1	66.7	400.5	218.8	64.3	821.4
1.3	65.6	61.5	433.9	237.0	56.3	854.4
1.4	61.0	57.1	467.3	255.3	49.8	890.4
1.5	56.9	53.3	500.7	273.5	44.5	928.8
1.6	53.3	50.0	534.0	291.7	40.1	969.2
1.7	50.2	47.1	567.4	309.9	36.4	1011.0
1.8	47.4	44.4	600.8	328.2	33.2	1054.0
1.9	44.9	42.1	634.2	346.4	30.5	1098.1
2.0	42.7	40.0	667.5	364.6	28.1	1143.0

STRESSES AT 10.0 g

Deflection f = 4.4 mm

Length = 80. mm

t (mm)	A (N/mm <sup>2</sup> )	B (N/mm <sup>2</sup> )	C (N/mm <sup>2</sup> )	D (N/mm <sup>2</sup> )	E (N/mm <sup>2</sup> )	Sigmax (N/mm <sup>2</sup> )
0.1	853.3	800.0	25.6	16.0	6509.5	8204.3
0.2	426.7	400.0	51.1	31.9	1689.9	2599.6
0.3	284.4	266.7	76.7	47.9	778.8	1454.5
0.4	213.3	200.0	102.2	63.8	453.7	1033.1
0.5	170.7	160.0	127.8	79.8	300.4	838.6
0.6	142.2	133.3	153.3	95.7	215.5	740.1
0.7	121.9	114.3	178.9	111.7	163.5	690.2
0.8	106.7	100.0	204.4	127.6	129.1	667.8
0.9	94.8	88.9	230.0	143.6	105.1	662.3
1.0	85.3	80.0	255.5	159.5	87.6	668.0
1.1	77.6	72.7	281.1	175.5	74.5	681.3
1.2	71.1	66.7	306.7	191.4	64.3	700.2
1.3	65.6	61.5	332.2	207.4	56.3	723.0
1.4	61.0	57.1	357.8	223.3	49.8	749.0
1.5	56.9	53.3	383.3	239.3	44.5	777.3
1.6	53.3	50.0	408.9	255.3	40.1	807.5
1.7	50.2	47.1	434.4	271.2	36.4	839.2
1.8	47.4	44.4	460.0	287.2	33.2	872.2
1.9	44.9	42.1	485.5	303.1	30.5	906.2
2.0	42.7	40.0	511.1	319.1	28.1	941.0

STRESSES AT 10.0 g

Deflection f = 5.4 mm

Length = 40. mm

t (mm)	A (N/mm <sup>2</sup> )	B (N/mm <sup>2</sup> )	C (N/mm <sup>2</sup> )	D (N/mm <sup>2</sup> )	E (N/mm <sup>2</sup> )	Sigmax (N/mm <sup>2</sup> )
0.1	853.3	800.0	125.5	31.9	7942.0	9752.7
0.2	426.7	400.0	250.9	63.8	2048.0	3189.4
0.3	284.4	266.7	376.4	95.7	938.0	1961.2
0.4	213.3	200.0	501.8	127.6	543.2	1586.0
0.5	170.7	160.0	627.3	159.5	357.7	1475.2
0.6	142.2	133.3	752.8	191.4	255.3	1475.1
0.7	121.9	114.3	878.2	223.3	192.7	1530.4
0.8	106.7	100.0	1003.7	255.3	151.4	1617.0
0.9	94.8	88.9	1129.1	287.2	122.7	1722.7
1.0	85.3	80.0	1254.6	319.1	101.9	1840.9
1.1	77.6	72.7	1380.1	351.0	86.3	1967.6
1.2	71.1	66.7	1505.5	382.9	74.3	2100.4
1.3	65.6	61.5	1631.0	414.8	64.7	2237.7
1.4	61.0	57.1	1756.4	446.7	57.1	2378.3
1.5	56.9	53.3	1881.9	478.6	50.9	2521.6
1.6	53.3	50.0	2007.4	510.5	45.7	2666.9
1.7	50.2	47.1	2132.8	542.4	41.3	2813.8
1.8	47.4	44.4	2258.3	574.3	37.6	2962.1
1.9	44.9	42.1	2383.7	606.2	34.5	3111.4
2.0	42.7	40.0	2509.2	638.1	31.7	3261.7

STRESSES AT 10.0 g

Deflection f = 5.4 mm

Length = 50. mm

t (mm)	A (N/mm <sup>2</sup> )	B (N/mm <sup>2</sup> )	C (N/mm <sup>2</sup> )	D (N/mm <sup>2</sup> )	E (N/mm <sup>2</sup> )	Sigmax (N/mm <sup>2</sup> )
0.1	853.3	800.0	80.3	25.5	7942.0	9701.1
0.2	426.7	400.0	160.6	51.1	2048.0	3086.3
0.3	284.4	266.7	240.9	76.6	938.0	1806.6
0.4	213.3	200.0	321.2	102.1	543.2	1379.9
0.5	170.7	160.0	401.5	127.6	357.7	1217.4
0.6	142.2	133.3	481.8	153.2	255.3	1165.8
0.7	121.9	114.3	562.1	178.7	192.7	1169.6
0.8	106.7	100.0	642.4	204.2	151.4	1204.7
0.9	94.8	88.9	722.6	229.7	122.7	1258.8
1.0	85.3	80.0	802.9	255.3	101.9	1325.4
1.1	77.6	72.7	883.2	280.8	86.3	1400.6
1.2	71.1	66.7	963.5	306.3	74.3	1481.9
1.3	65.6	61.5	1043.8	331.8	64.7	1567.6
1.4	61.0	57.1	1124.1	357.4	57.1	1656.7
1.5	56.9	53.3	1204.4	382.9	50.9	1748.4
1.6	53.3	50.0	1284.7	408.4	45.7	1842.1
1.7	50.2	47.1	1365.0	433.9	41.3	1937.5
1.8	47.4	44.4	1445.3	459.5	37.6	2034.2
1.9	44.9	42.1	1525.6	485.0	34.5	2132.1
2.0	42.7	40.0	1605.9	510.5	31.7	2230.8

STRESSES AT 10.0 g

Deflection f = 5.4 mm

Length = 60. mm

t (mm)	A (N/mm <sup>2</sup> )	B (N/mm <sup>2</sup> )	C (N/mm <sup>2</sup> )	D (N/mm <sup>2</sup> )	E (N/mm <sup>2</sup> )	Sigmax (N/mm <sup>2</sup> )
0.1	853.3	800.0	55.8	21.3	7942.0	9672.4
0.2	426.7	400.0	111.5	42.5	2048.0	3028.7
0.3	284.4	266.7	167.3	63.8	938.0	1720.2
0.4	213.3	200.0	223.0	85.1	543.2	1264.7
0.5	170.7	160.0	278.8	106.4	357.7	1073.5
0.6	142.2	133.3	334.6	127.6	255.3	993.1
0.7	121.9	114.3	390.3	148.9	192.7	968.1
0.8	106.7	100.0	446.1	170.2	151.4	974.4
0.9	94.8	88.9	501.8	191.4	122.7	999.7
1.0	85.3	80.0	557.6	212.7	101.9	1037.6
1.1	77.6	72.7	613.4	234.0	86.3	1083.9
1.2	71.1	66.7	669.1	255.3	74.3	1136.4
1.3	65.6	61.5	724.9	276.5	64.7	1193.3
1.4	61.0	57.1	780.6	297.8	57.1	1253.6
1.5	56.9	53.3	836.4	319.1	50.9	1316.5
1.6	53.3	50.0	892.2	340.3	45.7	1381.5
1.7	50.2	47.1	947.9	361.6	41.3	1448.1
1.8	47.4	44.4	1003.7	382.9	37.6	1516.0
1.9	44.9	42.1	1059.4	404.1	34.5	1585.1
2.0	42.7	40.0	1115.2	425.4	31.7	1655.0

STRESSES AT 10.0 g

Deflection f = 5.4 mm

Length = 70. mm

t (mm)	A (N/mm <sup>2</sup> )	B (N/mm <sup>2</sup> )	C (N/mm <sup>2</sup> )	D (N/mm <sup>2</sup> )	E (N/mm <sup>2</sup> )	Sigmax (N/mm <sup>2</sup> )
0.1	853.3	800.0	41.0	18.2	7942.0	9654.5
0.2	426.7	400.0	81.9	36.5	2048.0	2993.1
0.3	284.4	266.7	122.9	54.7	938.0	1666.7
0.4	213.3	200.0	163.9	72.9	543.2	1193.4
0.5	170.7	160.0	204.8	91.2	357.7	984.3
0.6	142.2	133.3	245.8	109.4	255.3	886.1
0.7	121.9	114.3	286.8	127.6	192.7	843.3
0.8	106.7	100.0	327.7	145.9	151.4	831.7
0.9	94.8	88.9	368.7	164.1	122.7	839.2
1.0	85.3	80.0	409.7	182.3	101.9	859.2
1.1	77.6	72.7	450.6	200.6	86.3	887.8
1.2	71.1	66.7	491.6	218.8	74.3	922.4
1.3	65.6	61.5	532.6	237.0	64.7	961.5
1.4	61.0	57.1	573.5	255.3	57.1	1004.0
1.5	56.9	53.3	614.5	273.5	50.9	1049.1
1.6	53.3	50.0	655.5	291.7	45.7	1096.2
1.7	50.2	47.1	696.4	309.9	41.3	1145.0
1.8	47.4	44.4	737.4	328.2	37.6	1195.1
1.9	44.9	42.1	778.4	346.4	34.5	1246.3
2.0	42.7	40.0	819.3	364.6	31.7	1298.4

STRESSES AT 10.0 g

Deflection f = 5.4 mm

Length = 80. mm

t (mm)	A (N/mm <sup>2</sup> )	B (N/mm <sup>2</sup> )	C (N/mm <sup>2</sup> )	D (N/mm <sup>2</sup> )	E (N/mm <sup>2</sup> )	Sigmax (N/mm <sup>2</sup> )
0.1	853.3	800.0	31.4	16.0	7942.0	9642.6
0.2	426.7	400.0	62.7	31.9	2048.0	2969.3
0.3	284.4	266.7	94.1	47.9	938.0	1631.1
0.4	213.3	200.0	125.5	63.8	543.2	1145.9
0.5	170.7	160.0	156.8	79.8	357.7	924.9
0.6	142.2	133.3	188.2	95.7	255.3	814.8
0.7	121.9	114.3	219.6	111.7	192.7	760.1
0.8	106.7	100.0	250.9	127.6	151.4	736.7
0.9	94.8	88.9	282.3	143.6	122.7	732.3
1.0	85.3	80.0	313.6	159.5	101.9	740.4
1.1	77.6	72.7	345.0	175.5	86.3	757.1
1.2	71.1	66.7	376.4	191.4	74.3	779.8
1.3	65.6	61.5	407.7	207.4	64.7	807.1
1.4	61.0	57.1	439.1	223.3	57.1	837.7
1.5	56.9	53.3	470.5	239.3	50.9	870.8
1.6	53.3	50.0	501.8	255.3	45.7	906.1
1.7	50.2	47.1	533.2	271.2	41.3	943.0
1.8	47.4	44.4	564.6	287.2	37.6	981.2
1.9	44.9	42.1	595.9	303.1	34.5	1020.5
2.0	42.7	40.0	627.3	319.1	31.7	1060.8



APPENDIX B

STRESSES AT 3.0 G.

STRESSES AT 3.0 g

Deflection f = 2.7 mm

Length = 40. mm

t (mm)	A (N/mm <sup>2</sup> )	B (N/mm <sup>2</sup> )	C (N/mm <sup>2</sup> )	D (N/mm <sup>2</sup> )	E (N/mm <sup>2</sup> )	Sigm (N/mm <sup>2</sup> )	Siga (N/mm <sup>2</sup> )	Sigmax (N/mm <sup>2</sup> )	Sigmin (N/mm <sup>2</sup> )
0.1	853.3	800.0	62.7	5.7	1226.1	1716.1	1231.8	2947.9	484.2
0.2	426.7	400.0	125.5	11.5	325.3	952.1	336.7	1288.9	615.4
0.3	284.4	266.7	188.2	17.2	152.9	739.3	170.1	909.4	569.2
0.4	213.3	200.0	250.9	22.9	90.7	664.3	113.6	777.9	550.6
0.5	170.7	160.0	313.6	28.7	61.0	644.3	89.7	734.0	554.6
0.6	142.2	133.3	376.4	34.4	44.5	651.9	78.9	730.8	573.1
0.7	121.9	114.3	439.1	40.1	34.2	675.3	74.3	749.6	601.0
0.8	106.7	100.0	501.8	45.9	27.4	708.5	73.2	781.7	635.3
0.9	94.8	88.9	564.6	51.6	22.5	748.3	74.1	822.4	674.1
1.0	85.3	80.0	627.3	57.3	19.0	792.6	76.3	869.0	716.3
1.1	77.6	72.7	690.0	63.1	16.3	840.3	79.4	919.7	760.9
1.2	71.1	66.7	752.8	68.8	14.2	890.5	83.0	973.6	807.5
1.3	65.6	61.5	815.5	74.5	12.6	942.7	87.1	1029.8	855.6
1.4	61.0	57.1	878.2	80.3	11.2	996.3	91.5	1087.8	904.8
1.5	56.9	53.3	940.9	86.0	10.1	1051.2	96.1	1147.3	955.1
1.6	53.3	50.0	1003.7	91.7	9.2	1107.0	100.9	1207.9	1006.1
1.7	50.2	47.1	1066.4	97.4	8.4	1163.7	105.8	1269.5	1057.8
1.8	47.4	44.4	1129.1	103.2	7.7	1221.0	110.9	1331.9	1110.1
1.9	44.9	42.1	1191.9	108.9	7.1	1278.9	116.1	1394.9	1162.8
2.0	42.7	40.0	1254.6	114.6	6.6	1337.3	121.3	1458.5	1216.0

STRESSES AT 3.0 g

Deflection f = 2.7 mm

Length = 50. mm

t (mm)	A (N/mm <sup>2</sup> )	B (N/mm <sup>2</sup> )	C (N/mm <sup>2</sup> )	D (N/mm <sup>2</sup> )	E (N/mm <sup>2</sup> )	Sigm (N/mm <sup>2</sup> )	Siga (N/mm <sup>2</sup> )	Sigmax (N/mm <sup>2</sup> )	Sigmin (N/mm <sup>2</sup> )
0.1	853.3	800.0	40.1	4.6	1226.1	1693.5	1230.7	2924.2	462.8
0.2	426.7	400.0	80.3	9.2	325.3	907.0	334.4	1241.4	572.5
0.3	284.4	266.7	120.4	13.8	152.9	671.6	166.7	838.2	504.9
0.4	213.3	200.0	160.6	18.3	90.7	573.9	109.0	683.0	464.9
0.5	170.7	160.0	200.7	22.9	61.0	531.4	84.0	615.4	447.4
0.6	142.2	133.3	240.9	27.5	44.5	516.4	72.0	588.4	444.4
0.7	121.9	114.3	281.0	32.1	34.2	517.2	66.3	583.5	450.9
0.8	106.7	100.0	321.2	36.7	27.4	527.8	64.0	591.9	463.8
0.9	94.8	88.9	361.3	41.3	22.5	545.0	63.8	608.8	481.2
1.0	85.3	80.0	401.5	45.9	19.0	566.8	64.9	631.7	501.9
1.1	77.6	72.7	441.6	50.4	16.3	591.9	66.8	658.7	525.1
1.2	71.1	66.7	481.8	55.0	14.2	619.5	69.3	688.8	550.3
1.3	65.6	61.5	521.9	59.6	12.6	649.1	72.2	721.3	576.9
1.4	61.0	57.1	562.1	64.2	11.2	680.2	75.4	755.6	604.7
1.5	56.9	53.3	602.2	68.8	10.1	712.4	78.9	791.3	633.5
1.6	53.3	50.0	642.4	73.4	9.2	745.7	82.6	828.2	663.1
1.7	50.2	47.1	682.5	78.0	8.4	779.8	86.4	866.1	693.4
1.8	47.4	44.4	722.6	82.5	7.7	814.5	90.3	904.8	724.2
1.9	44.9	42.1	762.8	87.1	7.1	849.8	94.3	944.1	755.5
2.0	42.7	40.0	802.9	91.7	6.6	885.6	98.3	984.0	787.3

STRESSES AT 3.0 g

Deflection f = 2.7 mm

Length = 60. mm

t (mm)	A (N/mm <sup>2</sup> )	B (N/mm <sup>2</sup> )	C (N/mm <sup>2</sup> )	D (N/mm <sup>2</sup> )	E (N/mm <sup>2</sup> )	Sigm (N/mm <sup>2</sup> )	Siga (N/mm <sup>2</sup> )	Sigmax (N/mm <sup>2</sup> )	Sigmin (N/mm <sup>2</sup> )
0.1	853.3	800.0	27.9	3.8	1226.1	1681.2	1229.9	2911.1	451.3
0.2	426.7	400.0	55.8	7.6	325.3	882.4	332.9	1215.3	549.5
0.3	284.4	266.7	83.6	11.5	152.9	634.8	164.4	799.1	470.4
0.4	213.3	200.0	111.5	15.3	90.7	524.9	106.0	630.8	418.9
0.5	170.7	160.0	139.4	19.1	61.0	470.1	80.2	550.2	389.9
0.6	142.2	133.3	167.3	22.9	44.5	442.8	67.4	510.2	375.4
0.7	121.9	114.3	195.2	26.8	34.2	431.4	61.0	492.3	370.4
0.8	106.7	100.0	223.0	30.6	27.4	429.7	57.9	487.6	371.8
0.9	94.8	88.9	250.9	34.4	22.5	434.6	56.9	491.6	377.7
1.0	85.3	80.0	278.8	38.2	19.0	444.1	57.2	501.4	386.9
1.1	77.6	72.7	306.7	42.0	16.3	457.0	58.4	515.4	398.6
1.2	71.1	66.7	334.6	45.9	14.2	472.3	60.1	532.4	412.2
1.3	65.6	61.5	362.4	49.7	12.6	489.6	62.3	551.9	427.4
1.4	61.0	57.1	390.3	53.5	11.2	508.4	64.7	573.1	443.7
1.5	56.9	53.3	418.2	57.3	10.1	528.4	67.4	595.9	461.0
1.6	53.3	50.0	446.1	61.1	9.2	549.4	70.3	619.7	479.1
1.7	50.2	47.1	474.0	65.0	8.4	571.2	73.4	644.6	497.9
1.8	47.4	44.4	501.8	68.8	7.7	593.7	76.5	670.2	517.2
1.9	44.9	42.1	529.7	72.6	7.1	616.7	79.7	696.5	537.0
2.0	42.7	40.0	557.6	76.4	6.6	640.3	83.1	723.3	557.2

STRESSES AT 3.0 g

Deflection f = 2.7 mm

Length = 70. mm

t (mm)	A (N/mm <sup>2</sup> )	B (N/mm <sup>2</sup> )	C (N/mm <sup>2</sup> )	D (N/mm <sup>2</sup> )	E (N/mm <sup>2</sup> )	Sigm (N/mm <sup>2</sup> )	Siga (N/mm <sup>2</sup> )	Sigmax (N/mm <sup>2</sup> )	Sigmin (N/mm <sup>2</sup> )
0.1	853.3	800.0	20.5	3.3	1226.1	1673.8	1229.4	2903.2	444.4
0.2	426.7	400.0	41.0	6.6	325.3	867.6	331.8	1199.5	535.8
0.3	284.4	266.7	61.4	9.8	152.9	612.6	162.7	775.3	449.8
0.4	213.3	200.0	81.9	13.1	90.7	495.3	103.8	599.1	391.5
0.5	170.7	160.0	102.4	16.4	61.0	433.1	77.4	510.5	355.7
0.6	142.2	133.3	122.9	19.7	44.5	398.5	64.1	462.6	334.3
0.7	121.9	114.3	143.4	22.9	34.2	379.6	57.1	436.7	322.4
0.8	106.7	100.0	163.9	26.2	27.4	370.5	53.6	424.1	317.0
0.9	94.8	88.9	184.3	29.5	22.5	368.1	52.0	420.1	316.0
1.0	85.3	80.0	204.8	32.8	19.0	370.2	51.8	421.9	318.4
1.1	77.6	72.7	225.3	36.0	16.3	375.6	52.4	428.0	323.3
1.2	71.1	66.7	245.8	39.3	14.2	383.6	53.6	437.1	330.0
1.3	65.6	61.5	266.3	42.6	12.6	393.5	55.2	448.6	338.3
1.4	61.0	57.1	286.8	45.9	11.2	404.9	57.1	461.9	347.8
1.5	56.9	53.3	307.2	49.1	10.1	417.5	59.3	476.7	358.2
1.6	53.3	50.0	327.7	52.4	9.2	431.1	61.6	492.7	369.5
1.7	50.2	47.1	348.2	55.7	8.4	445.5	64.1	509.5	381.4
1.8	47.4	44.4	368.7	59.0	7.7	460.5	66.7	527.2	393.9
1.9	44.9	42.1	389.2	62.2	7.1	476.2	69.4	545.6	406.8
2.0	42.7	40.0	409.7	65.5	6.6	492.3	72.1	564.5	420.2

STRESSES AT 3.0 g

Deflection f = 2.7 mm

Length = 80. mm

t (mm)	A (N/mm <sup>2</sup> )	B (N/mm <sup>2</sup> )	C (N/mm <sup>2</sup> )	D (N/mm <sup>2</sup> )	E (N/mm <sup>2</sup> )	Sigm (N/mm <sup>2</sup> )	Siga (N/mm <sup>2</sup> )	Sigmax (N/mm <sup>2</sup> )	Sigmin (N/mm <sup>2</sup> )
0.1	853.3	800.0	15.7	2.9	1226.1	1669.0	1229.0	2898.0	440.1
0.2	426.7	400.0	31.4	5.7	325.3	858.0	331.0	1189.0	527.0
0.3	284.4	266.7	47.0	8.6	152.9	598.2	161.5	759.7	436.7
0.4	213.3	200.0	62.7	11.5	90.7	476.1	102.2	578.2	373.9
0.5	170.7	160.0	78.4	14.3	61.0	409.1	75.4	484.5	333.7
0.6	142.2	133.3	94.1	17.2	44.5	369.7	61.7	431.3	308.0
0.7	121.9	114.3	109.8	20.1	34.2	346.0	54.3	400.2	291.7
0.8	106.7	100.0	125.5	22.9	27.4	332.1	50.3	382.4	281.8
0.9	94.8	88.9	141.1	25.8	22.5	324.8	48.3	373.2	276.5
1.0	85.3	80.0	156.8	28.7	19.0	322.2	47.7	369.8	274.5
1.1	77.6	72.7	172.5	31.5	16.3	322.8	47.9	370.7	275.0
1.2	71.1	66.7	188.2	34.4	14.2	326.0	48.6	374.6	277.3
1.3	65.6	61.5	203.9	37.3	12.6	331.1	49.8	380.9	281.2
1.4	61.0	57.1	219.6	40.1	11.2	337.6	51.4	389.0	286.3
1.5	56.9	53.3	235.2	43.0	10.1	345.5	53.1	398.6	292.4
1.6	53.3	50.0	250.9	45.9	9.2	354.3	55.0	409.3	299.2
1.7	50.2	47.1	266.6	48.7	8.4	363.9	57.1	421.0	306.7
1.8	47.4	44.4	282.3	51.6	7.7	374.1	59.3	433.4	314.8
1.9	44.9	42.1	298.0	54.5	7.1	385.0	61.6	446.6	323.4
2.0	42.7	40.0	313.6	57.3	6.6	396.3	64.0	460.3	332.4

STRESSES AT 3.0 g

Deflection f = 4.4 mm

Length = 40. mm

t (mm)	A (N/mm <sup>2</sup> )	B (N/mm <sup>2</sup> )	C (N/mm <sup>2</sup> )	D (N/mm <sup>2</sup> )	E (N/mm <sup>2</sup> )	Sigm (N/mm <sup>2</sup> )	Siga (N/mm <sup>2</sup> )	Sigmax (N/mm <sup>2</sup> )	Sigmin (N/mm <sup>2</sup> )
0.1	853.3	800.0	102.2	5.7	1952.8	1755.6	1958.6	3714.1	-203.0
0.2	426.7	400.0	204.4	11.5	507.0	1031.1	518.4	1549.5	512.7
0.3	284.4	266.7	306.7	17.2	233.6	857.8	250.8	1108.6	606.9
0.4	213.3	200.0	408.9	22.9	136.1	822.2	159.0	981.2	663.2
0.5	170.7	160.0	511.1	28.7	90.1	841.8	118.8	960.5	723.0
0.6	142.2	133.3	613.3	34.4	64.7	888.9	99.1	987.9	789.8
0.7	121.9	114.3	715.5	40.1	49.0	951.7	89.2	1040.9	862.5
0.8	106.7	100.0	817.7	45.9	38.7	1024.4	84.6	1109.0	939.8
0.9	94.8	88.9	920.0	51.6	31.5	1103.7	83.1	1186.8	1020.6
1.0	85.3	80.0	1022.2	57.3	26.3	1187.5	83.6	1271.1	1103.9
1.1	77.6	72.7	1124.4	63.1	22.3	1274.7	85.4	1360.1	1189.3
1.2	71.1	66.7	1226.6	68.8	19.3	1364.4	88.1	1452.5	1276.3
1.3	65.6	61.5	1328.8	74.5	16.9	1456.0	91.4	1547.4	1364.6
1.4	61.0	57.1	1431.0	80.3	14.9	1549.1	95.2	1644.3	1453.9
1.5	56.9	53.3	1533.3	86.0	13.3	1643.5	99.3	1742.8	1544.2
1.6	53.3	50.0	1635.5	91.7	12.0	1738.8	103.7	1842.6	1635.1
1.7	50.2	47.1	1737.7	97.4	10.9	1834.9	108.4	1943.3	1726.6
1.8	47.4	44.4	1839.9	103.2	10.0	1931.8	113.1	2044.9	1818.6
1.9	44.9	42.1	1942.1	108.9	9.1	2029.1	118.1	2147.2	1911.1
2.0	42.7	40.0	2044.3	114.6	8.4	2127.0	123.1	2250.1	2003.9

STRESSES AT 3.0 g

Deflection f = 4.4 mm

Length = 50. mm

t (mm)	A (N/mm <sup>2</sup> )	B (N/mm <sup>2</sup> )	C (N/mm <sup>2</sup> )	D (N/mm <sup>2</sup> )	E (N/mm <sup>2</sup> )	Sigm (N/mm <sup>2</sup> )	Siga (N/mm <sup>2</sup> )	Sigmax (N/mm <sup>2</sup> )	Sigmin (N/mm <sup>2</sup> )
0.1	853.3	800.0	65.4	4.6	1952.8	1718.8	1957.4	3676.2	-238.7
0.2	426.7	400.0	130.8	9.2	507.0	957.5	516.1	1473.6	441.4
0.3	284.4	266.7	196.3	13.8	233.6	747.4	247.4	994.8	500.0
0.4	213.3	200.0	261.7	18.3	136.1	675.0	154.5	829.5	520.6
0.5	170.7	160.0	327.1	22.9	90.1	657.8	113.0	770.8	544.7
0.6	142.2	133.3	392.5	27.5	64.7	668.1	92.2	760.2	575.9
0.7	121.9	114.3	457.9	32.1	49.0	694.1	81.1	775.3	613.0
0.8	106.7	100.0	523.4	36.7	38.7	730.0	75.4	805.4	654.6
0.9	94.8	88.9	588.8	41.3	31.5	772.5	72.8	845.3	699.7
1.0	85.3	80.0	654.2	45.9	26.3	819.5	72.1	891.7	747.4
1.1	77.6	72.7	719.6	50.4	22.3	869.9	72.8	942.7	797.1
1.2	71.1	66.7	785.0	55.0	19.3	922.8	74.3	997.1	848.5
1.3	65.6	61.5	850.4	59.6	16.9	977.6	76.5	1054.1	901.1
1.4	61.0	57.1	915.9	64.2	14.9	1034.0	79.1	1113.1	954.8
1.5	56.9	53.3	981.3	68.8	13.3	1091.5	82.1	1173.6	1009.4
1.6	53.3	50.0	1046.7	73.4	12.0	1150.0	85.4	1235.4	1064.6
1.7	50.2	47.1	1112.1	78.0	10.9	1209.4	88.9	1298.2	1120.5
1.8	47.4	44.4	1177.5	82.5	10.0	1269.4	92.5	1361.9	1176.9
1.9	44.9	42.1	1243.0	87.1	9.1	1330.0	96.3	1426.3	1233.7
2.0	42.7	40.0	1308.4	91.7	8.4	1391.0	100.2	1491.2	1290.9



STRESSES AT 3.0 g

Deflection f = 4.4 mm

Length = 60. mm

t (mm)	A (N/mm <sup>2</sup> )	B (N/mm <sup>2</sup> )	C (N/mm <sup>2</sup> )	D (N/mm <sup>2</sup> )	E (N/mm <sup>2</sup> )	Sigm (N/mm <sup>2</sup> )	Siga (N/mm <sup>2</sup> )	Sigmax (N/mm <sup>2</sup> )	Sigmin (N/mm <sup>2</sup> )
0.1	853.3	800.0	45.4	3.8	1952.8	1698.8	1956.7	3655.4	-257.9
0.2	426.7	400.0	90.9	7.6	507.0	917.5	514.6	1432.1	402.9
0.3	284.4	266.7	136.3	11.5	233.6	687.4	245.1	932.5	442.3
0.4	213.3	200.0	181.7	15.3	136.1	595.1	151.4	746.5	443.7
0.5	170.7	160.0	227.2	19.1	90.1	557.8	109.2	667.0	448.6
0.6	142.2	133.3	272.6	22.9	64.7	548.1	87.6	635.7	460.5
0.7	121.9	114.3	318.0	26.8	49.0	554.2	75.8	630.0	478.4
0.8	106.7	100.0	363.4	30.6	38.7	570.1	69.3	639.4	500.8
0.9	94.8	88.9	408.9	34.4	31.5	592.6	65.9	658.5	526.7
1.0	85.3	80.0	454.3	38.2	26.3	619.6	64.5	684.1	555.1
1.1	77.6	72.7	499.7	42.0	22.3	650.0	64.4	714.4	585.7
1.2	71.1	66.7	545.2	45.9	19.3	682.9	65.1	748.1	617.8
1.3	65.6	61.5	590.6	49.7	16.9	717.8	66.6	784.3	651.2
1.4	61.0	57.1	636.0	53.5	14.9	754.1	68.4	822.6	685.7
1.5	56.9	53.3	681.4	57.3	13.3	791.7	70.7	862.3	721.0
1.6	53.3	50.0	726.9	61.1	12.0	830.2	73.2	903.4	757.0
1.7	50.2	47.1	772.3	65.0	10.9	869.6	75.9	945.4	793.7
1.8	47.4	44.4	817.7	68.8	10.0	909.6	78.8	988.3	830.8
1.9	44.9	42.1	863.2	72.6	9.1	950.2	81.8	1031.9	868.4
2.0	42.7	40.0	908.6	76.4	8.4	991.3	84.9	1076.1	906.4

STRESSES AT 3.0 g

Deflection f = 4.4 mm

Length = 70. mm

t (mm)	A (N/mm <sup>2</sup> )	B (N/mm <sup>2</sup> )	C (N/mm <sup>2</sup> )	D (N/mm <sup>2</sup> )	E (N/mm <sup>2</sup> )	Sigm (N/mm <sup>2</sup> )	Siga (N/mm <sup>2</sup> )	Sigmax (N/mm <sup>2</sup> )	Sigmin (N/mm <sup>2</sup> )
0.1	853.3	800.0	33.4	3.3	1952.8	1686.7	1956.1	3642.8	-269.4
0.2	426.7	400.0	66.8	6.6	507.0	893.4	513.5	1406.9	379.9
0.3	284.4	266.7	100.1	9.8	233.6	651.2	243.5	894.7	407.8
0.4	213.3	200.0	133.5	13.1	136.1	546.8	149.2	696.1	397.6
0.5	170.7	160.0	166.9	16.4	90.1	497.6	106.5	604.0	391.1
0.6	142.2	133.3	200.3	19.7	64.7	475.8	84.3	560.1	391.5
0.7	121.9	114.3	233.6	22.9	49.0	469.8	72.0	541.8	397.9
0.8	106.7	100.0	267.0	26.2	38.7	473.7	64.9	538.6	408.8
0.9	94.8	88.9	300.4	29.5	31.5	484.1	61.0	545.1	423.1
1.0	85.3	80.0	333.8	32.8	26.3	499.1	59.0	558.1	440.1
1.1	77.6	72.7	367.1	36.0	22.3	517.5	58.4	575.8	459.1
1.2	71.1	66.7	400.5	39.3	19.3	538.3	58.6	596.9	479.7
1.3	65.6	61.5	433.9	42.6	16.9	561.1	59.5	620.5	501.6
1.4	61.0	57.1	467.3	45.9	14.9	585.4	60.8	646.2	524.6
1.5	56.9	53.3	500.7	49.1	13.3	610.9	62.5	673.4	548.4
1.6	53.3	50.0	534.0	52.4	12.0	637.4	64.4	701.8	572.9
1.7	50.2	47.1	567.4	55.7	10.9	664.7	66.6	731.3	598.1
1.8	47.4	44.4	600.8	59.0	10.0	692.6	68.9	761.6	623.7
1.9	44.9	42.1	634.2	62.2	9.1	721.2	71.4	792.6	649.8
2.0	42.7	40.0	667.5	65.5	8.4	750.2	74.0	824.2	676.2

STRESSES AT 3.0 g

Deflection f = 4.4 mm

Length = 80. mm

t (mm)	A (N/mm <sup>2</sup> )	B (N/mm <sup>2</sup> )	C (N/mm <sup>2</sup> )	D (N/mm <sup>2</sup> )	E (N/mm <sup>2</sup> )	Sigm (N/mm <sup>2</sup> )	Siga (N/mm <sup>2</sup> )	Sigmax (N/mm <sup>2</sup> )	Sigmin (N/mm <sup>2</sup> )
0.1	853.3	800.0	25.6	2.9	1952.8	1678.9	1955.7	3634.6	-276.8
0.2	426.7	400.0	51.1	5.7	507.0	877.8	512.7	1390.5	365.1
0.3	284.4	266.7	76.7	8.6	233.6	627.8	242.2	870.0	385.5
0.4	213.3	200.0	102.2	11.5	136.1	515.6	147.6	663.1	368.0
0.5	170.7	160.0	127.8	14.3	90.1	458.4	104.4	562.9	354.0
0.6	142.2	133.3	153.3	17.2	64.7	428.9	81.9	510.7	347.0
0.7	121.9	114.3	178.9	20.1	49.0	415.1	69.1	484.2	346.0
0.8	106.7	100.0	204.4	22.9	38.7	411.1	61.6	472.7	349.5
0.9	94.8	88.9	230.0	25.8	31.5	413.7	57.3	471.0	356.4
1.0	85.3	80.0	255.5	28.7	26.3	420.9	54.9	475.8	365.9
1.1	77.6	72.7	281.1	31.5	22.3	431.4	53.9	485.3	377.5
1.2	71.1	66.7	306.7	34.4	19.3	444.4	53.7	498.1	390.7
1.3	65.6	61.5	332.2	37.3	16.9	459.4	54.1	513.5	405.2
1.4	61.0	57.1	357.8	40.1	14.9	475.9	55.1	530.9	420.8
1.5	56.9	53.3	383.3	43.0	13.3	493.5	56.3	549.9	437.2
1.6	53.3	50.0	408.9	45.9	12.0	512.2	57.9	570.1	454.3
1.7	50.2	47.1	434.4	48.7	10.9	531.7	59.6	591.3	472.0
1.8	47.4	44.4	460.0	51.6	10.0	551.8	61.6	613.4	490.3
1.9	44.9	42.1	485.5	54.5	9.1	572.5	63.6	636.2	508.9
2.0	42.7	40.0	511.1	57.3	8.4	593.8	65.8	659.5	528.0

STRESSES AT 3.0 g

Deflection f = 5.4 mm

Length = 40. mm

t (mm)	A (N/mm <sup>2</sup> )	B (N/mm <sup>2</sup> )	C (N/mm <sup>2</sup> )	D (N/mm <sup>2</sup> )	E (N/mm <sup>2</sup> )	Sigm (N/mm <sup>2</sup> )	Siga (N/mm <sup>2</sup> )	Sigmax (N/mm <sup>2</sup> )	Sigmin (N/mm <sup>2</sup> )
0.1	853.3	800.0	125.5	5.7	2382.6	1778.8	2388.3	4167.1	-609.5
0.2	426.7	400.0	250.9	11.5	614.4	1077.6	625.9	1703.5	451.7
0.3	284.4	266.7	376.4	17.2	281.4	927.5	298.6	1226.1	628.9
0.4	213.3	200.0	501.8	22.9	163.0	915.2	185.9	1101.1	729.3
0.5	170.7	160.0	627.3	28.7	107.3	958.0	136.0	1093.9	822.0
0.6	142.2	133.3	752.8	34.4	76.6	1028.3	111.0	1139.3	917.3
0.7	121.9	114.3	878.2	40.1	57.8	1114.4	97.9	1212.3	1016.5
0.8	106.7	100.0	1003.7	45.9	45.4	1210.3	91.3	1301.6	1119.1
0.9	94.8	88.9	1129.1	51.6	36.8	1312.8	86.4	1401.3	1224.4
1.0	85.3	80.0	1254.6	57.3	30.6	1419.9	87.9	1507.8	1332.0
1.1	77.6	72.7	1380.1	63.1	25.9	1530.4	88.9	1619.3	1441.4
1.2	71.1	66.7	1505.5	68.8	22.3	1643.3	91.1	1734.4	1552.2
1.3	65.6	61.5	1631.0	74.5	19.4	1758.2	93.9	1852.1	1664.2
1.4	61.0	57.1	1756.4	80.3	17.1	1874.5	97.4	1971.9	1777.1
1.5	56.9	53.3	1881.9	86.0	15.3	1992.1	101.2	2093.4	1890.9
1.6	53.3	50.0	2007.4	91.7	13.7	2110.7	105.4	2216.1	2005.3
1.7	50.2	47.1	2132.8	97.4	12.4	2230.1	109.8	2339.9	2120.2
1.8	47.4	44.4	2258.3	103.2	11.3	2350.1	114.5	2464.6	2235.7
1.9	44.9	42.1	2383.7	108.9	10.3	2470.8	119.3	2590.0	2351.5
2.0	42.7	40.0	2509.2	114.6	9.5	2591.9	124.2	2716.0	2467.7

STRESSES AT 3.0 g

Deflection f = 5.4 mm

Length = 50. mm

t (min)	A (N/mm <sup>2</sup> )	B (N/mm <sup>2</sup> )	C (N/mm <sup>2</sup> )	D (N/mm <sup>2</sup> )	E (N/mm <sup>2</sup> )	Sigm (N/mm <sup>2</sup> )	Siga (N/mm <sup>2</sup> )	Sigmax (N/mm <sup>2</sup> )	Sigmin (N/mm <sup>2</sup> )
0.1	853.3	800.0	80.3	4.6	2382.6	1733.6	2387.2	4120.8	-653.6
0.2	426.7	400.0	160.6	9.2	614.4	987.3	623.6	1610.8	363.7
0.3	284.4	266.7	240.9	13.8	281.4	792.0	295.2	1087.2	496.8
0.4	213.3	200.0	321.2	18.3	163.0	734.5	181.3	915.8	553.2
0.5	170.7	160.0	401.5	22.9	107.3	732.1	130.2	862.4	601.9
0.6	142.2	133.3	481.8	27.5	76.6	757.3	104.1	861.4	653.2
0.7	121.9	114.3	562.1	32.1	57.8	798.3	89.9	888.2	708.3
0.8	106.7	100.0	642.4	36.7	45.4	849.0	82.1	931.1	766.9
0.9	94.8	88.9	722.6	41.3	36.8	906.4	78.1	984.4	828.3
1.0	85.3	80.0	802.9	45.9	30.6	968.3	76.4	1044.7	891.8
1.1	77.6	72.7	883.2	50.4	25.9	1033.5	76.3	1109.9	957.2
1.2	71.1	66.7	963.5	55.0	22.3	1101.3	77.3	1178.6	1024.0
1.3	65.6	61.5	1043.8	59.6	19.4	1171.0	79.0	1250.0	1092.0
1.4	61.0	57.1	1124.1	64.2	17.1	1242.2	81.3	1323.5	1160.9
1.5	56.9	53.3	1204.4	68.8	15.3	1314.6	84.0	1398.7	1230.6
1.6	53.3	50.0	1284.7	73.4	13.7	1388.0	87.1	1475.1	1301.0
1.7	50.2	47.1	1365.0	78.0	12.4	1462.3	90.4	1552.6	1371.9
1.8	47.4	44.4	1445.3	82.5	11.3	1537.1	93.8	1631.0	1443.3
1.9	44.9	42.1	1525.6	87.1	10.3	1612.6	97.5	1710.1	1515.1
2.0	42.7	40.0	1605.9	91.7	9.5	1688.5	101.2	1789.8	1587.3

STRESSES AT 3.0 g

Deflection f = 5.4 mm

Length = 60. mm

t (min)	A (N/mm <sup>2</sup> )	B (N/mm <sup>2</sup> )	C (N/mm <sup>2</sup> )	D (N/mm <sup>2</sup> )	E (N/mm <sup>2</sup> )	Sigm (N/mm <sup>2</sup> )	Siga (N/mm <sup>2</sup> )	Sigmax (N/mm <sup>2</sup> )	Sigmin (N/mm <sup>2</sup> )
0.1	853.3	800.0	55.8	3.8	2382.6	1709.1	2386.4	4095.5	-677.3
0.2	426.7	400.0	111.5	7.6	614.4	938.2	622.0	1560.2	316.1
0.3	284.4	266.7	167.3	11.5	281.4	718.4	292.9	1011.3	425.5
0.4	213.3	200.0	223.0	15.3	163.0	636.4	178.3	814.6	458.1
0.5	170.7	160.0	278.8	19.1	107.3	609.5	126.4	735.9	483.1
0.6	142.2	133.3	334.6	22.9	76.6	610.1	99.5	709.6	510.6
0.7	121.9	114.3	390.3	26.8	57.8	626.5	84.6	711.1	542.0
0.8	106.7	100.0	446.1	30.6	45.4	652.7	76.0	728.8	576.7
0.9	94.8	88.9	501.8	34.4	36.8	685.5	71.2	756.8	614.3
1.0	85.3	80.0	557.6	38.2	30.6	722.9	68.8	791.7	654.1
1.1	77.6	72.7	613.4	42.0	25.9	763.7	67.9	831.6	695.7
1.2	71.1	66.7	669.1	45.9	22.3	806.9	68.1	875.0	738.8
1.3	65.6	61.5	724.9	49.7	19.4	852.1	69.1	921.2	783.0
1.4	61.0	57.1	780.6	53.5	17.1	898.7	70.6	969.4	828.1
1.5	56.9	53.3	836.4	57.3	15.3	946.6	72.6	1019.2	874.0
1.6	53.3	50.0	892.2	61.1	13.7	995.5	74.8	1070.3	920.6
1.7	50.2	47.1	947.9	65.0	12.4	1045.2	77.4	1122.5	967.8
1.8	47.4	44.4	1003.7	68.8	11.3	1095.5	80.1	1175.6	1015.5
1.9	44.9	42.1	1059.4	72.6	10.3	1146.5	82.9	1229.4	1063.5
2.0	42.7	40.0	1115.2	76.4	9.5	1197.9	86.0	1283.8	1111.9

STRESSES AT 3.0 g

Deflection f = 5.4 mm

Length = 70. mm

t (mm)	A (N/mm <sup>2</sup> )	B (N/mm <sup>2</sup> )	C (N/mm <sup>2</sup> )	D (N/mm <sup>2</sup> )	E (N/mm <sup>2</sup> )	Sigm (N/mm <sup>2</sup> )	Siga (N/mm <sup>2</sup> )	Sigma <sub>x</sub> (N/mm <sup>2</sup> )	Sigmin (N/mm <sup>2</sup> )
0.1	853.3	800.0	41.0	3.3	2382.6	1694.3	2385.9	4080.2	-691.6
0.2	426.7	400.0	81.9	6.6	614.4	908.6	621.0	1529.6	287.6
0.3	284.4	266.7	122.9	9.8	281.4	674.0	291.2	965.2	382.8
0.4	213.3	200.0	163.9	13.1	163.0	577.2	176.1	753.3	401.1
0.5	170.7	160.0	204.8	16.4	107.3	535.5	123.7	659.2	411.8
0.6	142.2	133.3	245.8	19.7	76.6	521.4	96.3	617.6	425.1
0.7	121.9	114.3	286.8	22.9	57.8	523.0	80.7	603.7	442.2
0.8	106.7	100.0	327.7	26.2	45.4	534.4	71.6	606.0	462.8
0.9	94.8	88.9	368.7	29.5	36.8	552.4	66.3	618.7	486.1
1.0	85.3	80.0	409.7	32.8	30.6	575.0	63.3	638.3	511.7
1.1	77.6	72.7	450.6	36.0	25.9	600.9	61.9	662.9	539.0
1.2	71.1	66.7	491.6	39.3	22.3	629.4	61.6	691.0	567.8
1.3	65.6	61.5	532.6	42.6	19.4	659.7	62.0	721.8	597.7
1.4	61.0	57.1	573.5	45.9	17.1	691.6	63.0	754.6	628.6
1.5	56.9	53.3	614.5	49.1	15.3	724.7	64.4	789.1	660.3
1.6	53.3	50.0	655.5	52.4	13.7	758.8	66.1	824.9	692.7
1.7	50.2	47.1	696.4	55.7	12.4	793.7	68.1	861.8	725.6
1.8	47.4	44.4	737.4	59.0	11.3	829.2	70.3	899.5	759.0
1.9	44.9	42.1	778.4	62.2	10.3	865.4	72.6	938.0	792.8
2.0	42.7	40.0	819.3	65.5	9.5	902.0	75.0	977.0	827.0

STRESSES AT 3.0 g

Deflection f = 5.4 mm

Length = 80. mm

t (mm)	A (N/mm <sup>2</sup> )	B (N/mm <sup>2</sup> )	C (N/mm <sup>2</sup> )	D (N/mm <sup>2</sup> )	E (N/mm <sup>2</sup> )	Sigm (N/mm <sup>2</sup> )	Siga (N/mm <sup>2</sup> )	Sigmax (N/mm <sup>2</sup> )	Sigmin (N/mm <sup>2</sup> )
0.1	853.3	800.0	31.4	2.9	2382.6	1684.7	2385.5	4070.2	-700.8
0.2	426.7	400.0	62.7	5.7	614.4	889.4	620.1	1509.5	269.3
0.3	284.4	266.7	94.1	8.6	281.4	645.2	290.0	935.2	355.2
0.4	213.3	200.0	125.5	11.5	163.0	538.8	174.4	713.2	364.4
0.5	170.7	160.0	156.8	14.3	107.3	487.5	121.6	609.1	365.9
0.6	142.2	133.3	188.2	17.2	76.6	463.7	93.8	557.5	369.9
0.7	121.9	114.3	219.6	20.1	57.8	455.7	77.9	533.6	377.9
0.8	106.7	100.0	250.9	22.9	45.4	457.6	68.4	525.9	389.2
0.9	94.8	88.9	282.3	25.8	36.8	466.0	62.6	528.6	403.4
1.0	85.3	80.0	313.6	28.7	30.6	479.0	59.2	538.2	419.7
1.1	77.6	72.7	345.0	31.5	25.9	495.3	57.4	552.7	437.9
1.2	71.1	66.7	376.4	34.4	22.3	514.2	56.7	570.8	457.5
1.3	65.6	61.5	407.7	37.3	19.4	534.9	56.7	591.6	478.2
1.4	61.0	57.1	439.1	40.1	17.1	557.2	57.3	614.5	499.9
1.5	56.9	53.3	470.5	43.0	15.3	580.7	58.2	638.9	522.4
1.6	53.3	50.0	501.8	45.9	13.7	605.2	59.6	664.7	545.6
1.7	50.2	47.1	533.2	48.7	12.4	630.5	61.1	691.6	569.3
1.8	47.4	44.4	564.6	51.6	11.3	656.4	62.9	719.3	593.5
1.9	44.9	42.1	595.9	54.5	10.3	683.0	64.8	747.7	618.2
2.0	42.7	40.0	627.3	57.3	9.5	710.0	66.8	776.8	643.1