

# Lectures at NExT Summer Workshop 2020 (2021).

Matthew McCullough

*CERN, Theoretical Physics Department, Geneva, Switzerland*

## Contents

<b>1</b>	<b>Introduction</b>	<b>2</b>
<b>2</b>	<b>The Only Game in Town: EFT</b>	<b>2</b>
2.1	Spurions . . . . .	4
2.2	Small is not necessarily fine-tuned. . . . .	5
2.3	Masses Versus Scales . . . . .	6
<b>3</b>	<b>The Flavour and Neutrino Mass Puzzles</b>	<b>9</b>
<b>4</b>	<b>The Strong-CP Problem</b>	<b>9</b>
4.1	Massless quark solution . . . . .	12
4.2	Spontaneous CP Breaking . . . . .	13
4.3	The Axion . . . . .	13
4.4	Axion phenomenology. . . . .	15
<b>5</b>	<b>The Dark Matter Problem</b>	<b>19</b>
<b>6</b>	<b>The Hierarchy Problem</b>	<b>20</b>
6.1	Scale-Invariance . . . . .	22
6.2	Breaking the Wilsonian Picture . . . . .	23
6.3	Just input parameters. . . . .	24
6.4	Pseudo-Goldstone Higgs . . . . .	24
6.5	Supersymmetry . . . . .	34
6.6	Extra Dimensions . . . . .	49
6.7	Cosmological Relaxation . . . . .	59
<b>7</b>	<b>Where do we stand now?</b>	<b>63</b>

<b>8 Homework</b>	<b>63</b>
8.1 Monday . . . . .	63
8.2 Tuesday . . . . .	64
8.3 Wednesday . . . . .	64

# 1 Introduction

What is Physics Beyond the Standard Model? Well, we know it exists, which is a good start. This follows from the fact that the Standard Model (SM) alone does not explain a number of experimental observations. Dark matter and neutrino masses, for example. These things *exist*, yet we don't know what the dark matter is, or how neutrino masses originate. There are other experimental observations which, while accommodated within the SM, are nonetheless downright peculiar. Puzzles of this form include the Strong-CP problem, the hierarchy problem, and the unexplained hierarchical patterns of quark and lepton masses. These puzzles are not due to a contradiction with experiment, yet they are not simply æsthetic. As we will see, they may be hints towards the deeper structural aspects of the SM. The goal of a Beyond the Standard Model (BSM) researcher is thus very simple to state: Find solutions to these puzzles and determine how to confirm or deny their existence with experiment.

In these lectures I hope to frame these puzzles in a way that is accessible to anyone familiar with the SM, and sketch solutions that are *currently* under investigation. There are many excellent textbooks on topics such as Supersymmetry. I wish to avoid duplication of material, thus I will try to focus on material that is not in textbooks, and provide the relevant references to the literature instead. I will also intentionally introduce and explain as much common jargon as I can. Jargon is necessary for efficient communication of complex notions however it is sometimes tricky early to understand what is precisely implied by certain words, so hopefully we can cover as many terms as possible.<sup>1</sup>

Finally: This is an early iteration of these notes, so typos and errors (hopefully forgivable) are guaranteed. Please take this opportunity to point them out and chide me for them. We will all benefit.

# 2 The Only Game in Town: EFT

To solve any of the above problems one must construct theoretical models. Now, if you manage to construct the entire fundamental theory of everything, explaining all questions from dark matter to the nature of quantum gravity, then maybe you don't need to play by the rules of EFT. The rest of us mere mortal souls must instead all play by the same rulebook. This rulebook is called Effective Field Theory (EFT), and it is the only sensible way to factorise the physics of different length scales into bite-size chunks.

---

<sup>1</sup>Jargon is also, sadly, often used as a vehicle to conceal ones lack of understanding, but we'll try to avoid that.

## Operators

The recipe is very simple. Take every field in your theory, construct local operators, and put them in your Lagrangian. An operator is simply a function of the fields, and by local I mean one in which the interaction is local in position space, but in practise this usually means you don't do something daft like taking the square root of a derivative. Everywhere that there should be a coefficient of an operator that is dimensionful, just parameterise it with the appropriate powers of  $\Lambda$  and some unknown coefficient, let's call it  $c$ , that may as well be  $\mathcal{O}(1)$  for all you know. The Lagrangian is the action for the field theory.

## Symmetries

Now, if you are to have a symmetry at low energies (usually called the IR) you will have to respect it at high energies (called the UV), thus we impose rules on the types of operators allowed, which is that they don't break the symmetries we expect to be observed in nature. That's about the long and short of it. Let's take an example. If we call the left-handed electron field  $E_L$  and a left-handed quark field  $Q_L$ , then we cannot write a four-fermion operator such as

$$\mathcal{L} \supset \frac{c}{\Lambda^2} (\bar{E}_R \cdot E_L) (\bar{E}_R \cdot Q_L) \quad (2.1)$$

where the dot implies the usual spinor contraction for the Weyl fermion. This operator explicitly breaks the symmetry of QCD, as well as electromagnetism. Rather, we should write something like

$$\mathcal{L} \supset \frac{c}{\Lambda^2} (\bar{E}_R \cdot E_L) (\bar{Q}_R \cdot Q_L) \quad (2.2)$$

which does respect the symmetries. This is a perfectly acceptable operator, and is actually realised in nature, where the constraints on the coefficient from BSM effects require  $\Lambda/\sqrt{c} \gtrsim 10$ 's TeV. The mass dimension of a fermion in 4D is  $d = 3/2$ , thus this operator is at  $d = 6$ . If you would like to see all dimension 6 operators in the SM then look here [1].

## Relevance

Since any scattering amplitude will scale with energy like  $(E/\Lambda)^n$  for any operator, those with lower mass dimension are most relevant at low energies. In fact, we often refer to operators with dimension  $d < 4$  as relevant, those with  $d = 4$  as marginal, and those with  $d > 4$  as irrelevant. In the latter case, not because they are uninteresting, but because they are less important at low energies. Turning this on its head, we see that if we want to get access to these operators we must either go to higher energies, to make the operator more important in the scattering process, or measure processes with such a high precision that we can observe the small deviations predicted by higher dimension operators for  $E \ll \Lambda$ .

## Power Counting

One might make assumptions based on aesthetic arguments, or motivations between ideas about what exists at higher energies, as to the coefficients of these operators, usually called 'Wilson Coefficients'. Indeed, there is a very useful technique known as naive dimensional analysis (NDA), that can be very useful to organise where additional factors of  $4\pi$ , or gauge

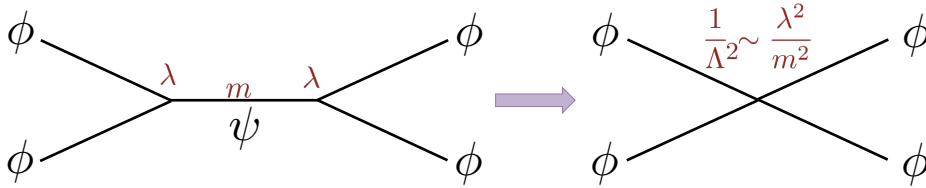

**Figure 1:** Generating higher dimension operators by integrating out fields.

couplings, might show up (see [2]). However one should always remember that, unless observed experimentally measured, these are assumptions, however well-motivated they may be.

## The Cutoff

We normally refer to the common scale  $\Lambda$  as the cutoff. The reason for this is that as we approach that energy the scattering amplitudes, proportional to  $(E/\Lambda)^n$ , start to approach unity. When this happens the perturbative series will not converge, since  $1^n = 1$ , and operators of arbitrarily high dimension are contributing equally to the scattering amplitude. When this occurs we must specify the new full theory of microscopic physics that occurs at the scale  $\Lambda$ , where now this new physics will involve new fields (sometimes we say new degrees of freedom, or new particles, all meaning the same thing). In other words, when this happens we are using the wrong description: The physics at high energies can no longer be factorised out and we must specify it. For the example of eq. (2.2), we may have a new scalar particle that has generated this interaction, as in fig. 1, and we should now include all of the effects of this particle in our calculations.

With all of this in mind, we know what it means to define an EFT. An EFT is entirely defined by it's field content and its symmetries, and to some extent the cutoff. No more and no less. Once so defined, you can make choices as to what values the coefficients of operators take, and calculate!

## 2.1 Spurions

The concept of spurions is extremely useful in BSM theories. The idea is the following: Imagine your theory would respect some global symmetry,  $\mathcal{G}$ , but for a single operator in the theory which actually breaks this symmetry explicitly. Let's call the coefficient of this operator  $\tilde{c}$ . Let us further assume that this is the only one parameter in the theory that breaks the symmetry.

In a quantum field theory everything that can happen will happen, by which I mean that if you go to high enough loop order then every physical observable will eventually feel the effects of  $\tilde{c}$ . However, any effects associated with the breaking of the symmetry will always be accompanied by  $\tilde{c}$ . If we take the limit  $\tilde{c} \rightarrow 0$  then a symmetry is restored. This is tremendously useful.

Let us see how this works in practise. Consider a single complex scalar field and a Weyl

fermion, both with mass and interactions that we will describe later. The action is

$$\mathcal{S} = - \int d^4x \left[ |\partial_\mu \phi|^2 + i\psi^\dagger \not{\partial} \psi - M_\phi^2 |\phi|^2 + \frac{1}{2} M_\psi \psi^2 \right] + \mathcal{S}_{\text{Int}} \dots \quad , \quad (2.3)$$

where the usual spinor contractions are implied. Now, there are only two parameters here, but there are actually four non-trivial symmetries to consider here. Let us first take  $M_\phi \rightarrow 0$ . In this limit the scalar field recovers a complex constant shift symmetry  $\phi \rightarrow \phi + c$ , where  $c$  is any complex number. This means that, if any interactions of the scalar respect this symmetry, such as derivative interactions with other fields,  $\partial_\mu \phi \mathcal{O}^\mu$ , where  $\mathcal{O}$  is any local operator involving other fields in the theory, then at no order in perturbation theory will the mass of the scalar ever become larger than  $M_\phi$ .

There is a similar story for the fermion, where in the limit  $M_\psi \rightarrow 0$  we recover what is called a chiral symmetry,  $\psi \rightarrow e^{i\theta} \psi$ . So the same holds true here: If all other interactions respect the chiral symmetry, then the fermion will never obtain corrections to its mass greater than  $M_\psi$ .

In both of these limits, if we ignore gravity then there is also a scale symmetry, wherein the fields and coordinates are rescaled by factors such that the action remains the same. This symmetry commonly shows up in particle physics models, however, scale invariance is usually broken by quantum corrections, such as in the running of the QCD gauge coupling, thus care should be taken in employing this symmetry in models with interactions.

The final symmetry arises when  $M_\psi = M_\phi$ . In this limit the scalar and fermion have the same mass, and the symmetry recovered is actually Supersymmetry! This means that if all other interactions respect the Supersymmetry, the scalar and fermion will always have the same mass. We will return to Supersymmetry in due course.

The same arguments apply not only for things like mass terms, but actually for any operator in the theory in which a symmetry is recovered when the coefficient of that operator goes to zero. This is clearly an extremely powerful line of reasoning, and it leads us to the concept of technical naturalness, discussed in details here [3]. The basic idea is that if a parameter (spurion) in a theory breaks a particular symmetry, then the size of that parameter will not receive any large corrections in perturbation theory, so it is technically natural for it to be small.

## 2.2 Small is not necessarily fine-tuned.

The spurion approach makes clear that the question of whether or not parameters in a theory are fine-tuned is very sharply defined: If a parameter in a theory is unstable against quantum corrections, then keeping it smaller than those corrections requires fine-tuning. This does not imply, however, that any small parameter is fine-tuned. Let us take the electron Yukawa coupling. In natural units this is a very small number  $\lambda_E \sim 511\text{keV}/174\text{GeV} \approx 3 \times 10^{-5}$ , such that when electroweak symmetry is broken the electron mass is as observed.

Written in terms of the left and right-handed fields the Yukawa interaction is

$$\mathcal{L}_{Yukawa} = \lambda_E H L E^c + h.c. \dots \quad . \quad (2.4)$$

Now, this is the only parameter (spurion) in the theory that breaks the electron chiral symmetry  $H \rightarrow H, L \rightarrow e^{i\theta} L, E^c \rightarrow e^{i\theta} E^c$ . This means that at the quantum level it will not

receive any corrections that aren't proportional to  $\lambda_E$  and if it starts small it stays small. Now it is certainly a puzzle as to why the electron Yukawa is exponentially smaller than the top-quark Yukawa. In fact, there is a notion, outlined by Dirac in [4] that such unexpectedly large or small mass ratios are unnatural in the sense that we would not expect them to necessarily arise from some fundamental theory in which all parameters are comparable. However, the electron Yukawa *is not fine-tuned*, as it breaks a symmetry and it is thus technically natural for it to be small. If there were some other source of electron chiral symmetry breaking in the Lagrangian which was much larger, then the electron Yukawa would be considered fine-tuned, but that is not the case.

### 2.3 Masses Versus Scales

Another useful tool to aid the BSM theorist is to keep in mind the fundamental difference between masses and interaction scales. To appreciate the difference between masses and scales it is useful to reinstate in the action the appropriate powers of  $\hbar$ , while working in units with  $c = 1$ . This means that time and length have identical units, while we distinguish between units of energy ( $E$ ) and length ( $L$ ). Let us consider a general 4D action involving scalar ( $\phi$ ), fermion ( $\psi$ ), and vector gauge fields ( $A_\mu$ ), normalised such that all kinetic terms and commutation relations are canonical. Moreover, we express masses in units of inverse length, so that all mass parameters in the Lagrangian are written in terms of  $\tilde{m} = m/\hbar$ . In our basis, *there are no explicit factors of  $\hbar$*  in the classical Lagrangian in position space. With these assumptions, the dimensionality of the quantities of interest, including gauge couplings  $g$ , Yukawa couplings  $y$ , and scalar quartic couplings  $\lambda$ , are

$$[\hbar] = EL, \quad [\mathcal{L}] = EL^{-3}, \quad [\phi] = [A_\mu] = E^{1/2}L^{-1/2}, \quad [\psi] = E^{1/2}L^{-1}, \quad (2.5)$$

$$[\partial] = [\tilde{m}] = L^{-1}, \quad [g] = [y] = E^{-1/2}L^{-1/2}, \quad [\lambda] = E^{-1}L^{-1}. \quad (2.6)$$

Canonical dimensions in natural units with  $\hbar = 1$  are recovered by identifying  $E = L^{-1}$ .

Note that  $[g^2] = [y^2] = [\lambda]$ , in agreement with the usual perturbative series. It is also important to remark that loop effects do not modify the dimensionality counting. Indeed, one can prove that, in this basis, each loop in momentum space carries one factor of  $\hbar$ . So each loop is accompanied by factors such as  $\hbar g^2/(4\pi)^2$ ,  $\hbar y^2/(4\pi)^2$ , or  $\hbar \lambda/(4\pi)^2$ , which are all dimensionless quantities in units of  $L$  and  $E$ , and thus do not alter the dimensionality of the quantity under consideration.

Unlike the case of natural units, dimensional analysis shows that couplings, and not only masses, are dimensionful quantities. Then, for our discussion, it is useful to introduce convenient units of mass  $\tilde{M} \equiv L^{-1}$  and coupling  $C \equiv E^{-1/2}L^{-1/2}$ .

Let us now add to the Lagrangian an effective operator of canonical dimension  $d$  of the general form

$$\frac{1}{\Lambda^{d-4}} \partial^{n_D} \Phi^{n_B} \psi^{n_F}. \quad (2.7)$$

Here  $n_D$  is the number of derivatives,  $n_B$  the number of boson fields ( $\Phi = \phi, A_\mu$ ), and  $n_F$  the number of fermion fields, with  $n_D + n_B + \frac{3}{2}n_F = d$ . The dimensionful quantity  $\Lambda$  that defines the strength of the effective interaction will be called *scale*. Its dimensionality is

$$[\Lambda] = \frac{\tilde{M}}{C^{\frac{n-2}{d-4}}}, \quad (2.8)$$

where  $n = n_B + n_F$  is the total number of fields involved in the operator. This result can be immediately understood by recalling that each field carries an inverse power of  $C$  ( $[\phi] = [A_\mu] = \tilde{M}C^{-1}$ ,  $[\psi] = \tilde{M}^{3/2}C^{-1}$ ) and the Lagrangian dimensionality is  $[\mathcal{L}] = \tilde{M}^4C^{-2}$ .

Since the exponent of  $C$  in Eq.(2.8) is strictly positive, scales and masses are measured in different units and are not commensurable quantities. A scale is the ratio between a mass and a certain power of couplings. Equation (2.8) dictates the minimum number of couplings required to define the corresponding scale. If the operator is generated at the loop level in the fundamental theory, the number of couplings entering the scale  $\Lambda$  can be larger than Eq.(2.8) prescribes. However, as previously discussed, these couplings are always accompanied by an appropriate power of  $\hbar$  and do not alter the conclusion from dimensional analysis: *masses and scales are incommensurable*.

Not only have masses and scales different dimensionality, but they also carry different physical meanings. A mass is associated with  $E_m = \tilde{m}\hbar$ , the energy at which new degrees of freedom appear. A scale is associated with  $E_\Lambda = \Lambda\hbar^{\frac{2d-n-6}{2(d-4)}}$ , the energy at which the theory becomes strongly coupled, if no new degrees of freedom intervene to modify the effective description. Therefore, a scale carries information on the strength of the interaction, but gives no information about the energy scale of new dynamics. The latter is given by the product of a scale times couplings, *i.e.* by mass.

Let's flesh out an example, that we may return to later. Take a complex scalar field  $\phi$  with an action invariant under the global U(1) transformation  $\phi \rightarrow e^{i\theta}\phi$ . We may choose a Higgs-like potential for  $\phi$ , such that it obtains a vacuum expectation value  $|\langle\phi\rangle| = f\sqrt{2}$ . We may parameterise the two degrees of freedom in  $\phi$  however we wish. One option is  $\phi = (f + \phi_r + i\phi_i)/\sqrt{2}$ , however another equally valid parameterisation is  $\phi = (f + \rho)e^{ia/f}/\sqrt{2}$ .

In this parameterisation

$$\mathcal{L} = |\partial_\mu\phi|^2 - \lambda(|\phi|^2 - f^2/2)^2 \quad (2.9)$$

$$= \frac{1}{2} \left(1 + \frac{\rho}{f}\right)^2 (\partial_\mu a)^2 + \frac{1}{2}(\partial_\mu\rho)^2 - \frac{\lambda}{4} ((f + \rho)^2 - f^2)^2 \quad (2.10)$$

We usually refer to  $\rho$  as the ‘radial mode’, which has mass  $m_\rho^2 = 2\lambda f^2$ . The field  $a$  is massless, and enjoys a shift symmetry  $a \rightarrow a + f$ . Fields of this type are known as Nambu-Goldstone bosons (much more on this later). At energies far below the mass of the radial mode we may integrate it out, to determine the EFT that describes the interactions of the Goldstone boson. Doing this we find an EFT given by

$$\mathcal{L} \frac{1}{2}(\partial_\mu a)^2 + \frac{1}{\Lambda^4}(\partial_\mu a)^4 \quad (2.11)$$

where  $\Lambda^4 = 2\lambda f^4 = m_\rho^2 f^2$ . Now, imagine we could scatter these Goldstone bosons off one another. Doing so, we would measure the interaction scale  $\Lambda$ . We could surmise that this effective description must break down at energies  $E \sim \Lambda$ , since the interactions becomes strongly coupled here ( $E/\Lambda \sim 1$ ). If we weren't thinking carefully we may even be sloppy enough to assume that this is the energy where the interaction is ‘UV-completed’. In other words, we could think this energy is the mass scale at which the particles responsible for the higher dimension interaction appear. However, this could be totally wrong! The new particles show up at  $m_\rho$ , which is a factor  $(2\lambda)^{1/4}$  below  $\Lambda$ . If  $\lambda$  were very small, the theory

could be UV-completed orders of magnitude before you reach the interaction scale. The moral of the story is that in an EFT one should always keep in mind that the coefficient of an operator alone does not at all signify the mass scale of the responsible new particles, and the easiest way to see this is to remember that masses and scales are not the same thing.

Let us consider some more examples of the relation between mass, scale, and coupling in familiar theories. The first example is the four-fermion interaction in the Fermi theory. Equation (2.8) with  $n = 4$  and  $d = 6$  gives

$$[\Lambda] = [G_F^{-1/2}] = \frac{[M_W]}{[g]} . \quad (2.12)$$

So  $M_W$  is a mass and  $G_F^{-1/2}$  a scale. This is consistent with the notion that the new degrees of freedom in the electroweak theory occur at  $E \sim M_W$  and not at  $E \sim G_F^{-1/2}$ . The latter is the energy scale at which perturbative unitarity would break down, in the absence of the weak gauge bosons. Note also that, since  $G_F^{-1/2} \sim v$ , the Higgs vacuum expectation value has the meaning of a scale, and not of a mass. Indeed, in the Higgs mechanism, physical masses are always given by the product of  $v$  times a coupling constant. This result has a more general validity, which goes beyond the Higgs mechanism. From Eq.(2.5) we see that the vacuum expectation value of a scalar field has always the dimension of a scale  $[\langle\phi\rangle] = \tilde{M}/C$ .

Another example is the Weinberg operator  $\ell\ell HH/\Lambda_\nu$  generating neutrino Majorana masses in the SM. In this case  $n = 4$  and  $d = 5$ , and Eq.(2.8) gives

$$[\Lambda_\nu] = \frac{[M_R]}{[\lambda_\nu^2]} , \quad (2.13)$$

where  $M_R$  is the right-handed neutrino mass and  $\lambda_\nu$  is the Yukawa coupling that participates in the see-saw mechanism. Since the physical neutrino mass is  $m_\nu = v^2/\Lambda_\nu = \lambda_\nu^2 v^2/M_R$ , we immediately see that the powers of couplings correctly match to give  $m_\nu$  the dimension of mass. Thus the UV-completion of the Weinberg operator may enter at energies far below  $\Lambda_\nu$  if there is a small coupling in the underlying theory. This is the reason we could have right-handed neutrinos as low as a few keV, if one is happy to tolerate the minute coupling required.

Finally, let us consider the graviton coupling in linearised general relativity. With  $n = 3$  and  $d = 5$ , Eq.(2.8) gives

$$[M_P] = \frac{[M_s]}{[g_s]} , \quad (2.14)$$

where we could, for example, interpret  $M_s$  and  $g_s$  as the string mass and string coupling, respectively. From this perspective it is evident that  $M_P$  is a scale and not a mass. Therefore, without any specific assumptions on the underlying couplings, we cannot conclude that the new degrees of freedom of quantum gravity must appear in the proximity of  $M_P$ !

## Summary

This concludes our micro-tour of useful BSM Theory-widgets. While it took some time to cover these aspects, they provide a crucial compass for navigating the landscape of BSM theories. Before tackling the main subjects of these lectures, let me first mention an area that is central in BSM theory, but I will not have time to cover.



### 3 The Flavour and Neutrino Mass Puzzles

While not covered in these lectures, theorists continue to puzzle over the strange hierarchical patterns in the quark and lepton Yukawa couplings, including the CKM matrix for the quarks and the PMNS matrix for the leptons, as well as the origin of the tiny neutrino masses. A great deal of theoretical and experimental activity is ongoing to confront these questions, and there are always exciting anomalies to think about and construct models for in these fields.

### 4 The Strong-CP Problem

The strong-CP problem concerns a beguiling aspect of the SM, where reasoning based on perturbation theory fails spectacularly, and very beautiful quantum field theory was required to untangle the physics. It is concerned with a CP-odd interaction

$$\mathcal{L} = \theta \frac{g^2}{32\pi^2} \epsilon_{\mu\nu\alpha\beta} G_{\mu\nu}^a G_{\alpha\beta}^a \quad , \quad (4.15)$$

where  $\theta$  is an unfixed parameter. This rather innocuous looking term brings us face-to-face with the difference between classical and quantum theories in two important ways:

- a) In a classical theory a symmetry of the Lagrangian is a symmetry of the physics. In a quantum theory a symmetry of the path integral is a symmetry of the physics. The two are not one and the same if the path integral measure is not invariant under a symmetry.
- b) A total derivative term, which essentially lives on the boundaries of space time, does not change the equations of motion and is thus classically unimportant in perturbation theory. However, in a quantum theory it can still have dramatic physical consequences.

Let us investigate these two aspects in more detail.

#### Symmetries: Quantum or Classical?

Consider a theory with a massless Dirac quark in the fundamental representation of  $SU(3)$ .<sup>2</sup> The fermionic part of the action is

$$\mathcal{L} = i\bar{\psi}\gamma^\mu D_\mu\psi \quad . \quad (4.16)$$

This action is invariant under the global chiral field redefinition  $\psi \rightarrow e^{i\alpha\gamma_5}\psi$ . Since this is a symmetry of the classical action we would usually expect it to be symmetry of the full theory. Noether's theorem means that there must therefore be a conserved current. To derive the current conservation equation for a global symmetry a quick method is to promote the global transformation to a local one  $\alpha \rightarrow \alpha(x)$ , perform a symmetry transformation, and

---

<sup>2</sup>This discussion will sketch the more detailed explanation given in [5,6], where the Fujikawa explanation [7,8] is given.

then apply the variational principle to  $\alpha(x)$  to find a current conservation equation  $\partial_\mu J^\mu$  under the restriction that  $\alpha(x)$  is a constant.<sup>3</sup>

In a quantum theory physical predictions follow from the path integral, which is

$$Z = \int \mathcal{D}\bar{\psi}\mathcal{D}\psi \exp \left[ i \int d^4x i\bar{\psi}\gamma^\mu D_\mu\psi \right] , \quad (4.17)$$

thus for physical predictions in the quantum field theory to be invariant the path integral measure  $\mathcal{D}\bar{\psi}\mathcal{D}\psi$  must also be invariant under a symmetry transformation. Under the local chiral transformation we have

$$\mathcal{D}\bar{\psi}\mathcal{D}\psi \rightarrow |J|^{-2}\mathcal{D}\bar{\psi}\mathcal{D}\psi , \quad (4.18)$$

where  $J$  is the Jacobian, in full analogy with the Jacobian arising in a change of variables in a multiple integral. There is not time to go into the derivation of this Jacobian, however I urge the interested reader (you should be interested), to go and read the relevant chapters of [5,6] for an explanation, as this is fundamental stuff! It turns out that, by using functional determinant methods, and a clever bit of divergence regulation, the Jacobian may be written

$$\mathcal{J} = \exp \left[ i \int d^4x \alpha(x) \frac{g^2}{32\pi^2} \epsilon_{\mu\nu\alpha\beta} G_{\mu\nu}^a G_{\alpha\beta}^a \right] . \quad (4.19)$$

Combining this with the variation from the action, we have

$$Z = \int \mathcal{D}\bar{\psi}\mathcal{D}\psi \exp i \int d^4x \left[ i\bar{\psi}\gamma^\mu D_\mu\psi + \alpha(x) \left( \partial_\mu J^\mu + \frac{g^2}{32\pi^2} \epsilon_{\mu\nu\alpha\beta} G_{\mu\nu}^a G_{\alpha\beta}^a \right) \right] . \quad (4.20)$$

This is remarkable! A symmetry of the classical action is, in fact, not a symmetry of the quantum theory. Since it is not a symmetry it cannot be spontaneously broken, thus when quarks condense one should not expect a pseudo-Goldstone boson associated with the spontaneously broken U(1) chiral symmetry, as it is not a symmetry of the theory. Indeed, this is the reason one does not have a light  $\eta'$  meson, since the  $\eta'$  is associated with this spontaneous symmetry breaking.

Let us now consider a theory in which the quarks now have Dirac mass, which may, in general, contain a phase, and the usual topological term

$$Z = \int \mathcal{D}\bar{\psi}\mathcal{D}\psi \exp \left[ i \int d^4x i\bar{\psi} (\gamma^\mu D_\mu + m e^{-2i\theta_q \gamma_5}) \psi + \theta \frac{g^2}{32\pi^2} \epsilon_{\mu\nu\alpha\beta} G_{\mu\nu}^a G_{\alpha\beta}^a \right] . \quad (4.21)$$

Usually, we would understand the quark mass phase to be unphysical, as we could simply perform the chiral rotation  $\psi \rightarrow e^{i\theta_q \gamma_5} \psi$  to eliminate it from the action entirely. However, if we do perform this rotation we simply shift the phase into the topological term

$$Z \rightarrow \int \mathcal{D}\bar{\psi}\mathcal{D}\psi \exp \left[ i \int d^4x i\bar{\psi} (\gamma^\mu D_\mu + m) \psi + (\theta + \theta_q) \frac{g^2}{32\pi^2} \epsilon_{\mu\nu\alpha\beta} G_{\mu\nu}^a G_{\alpha\beta}^a \right] . \quad (4.22)$$

This can be understood from eq. (4.20), where a constant rotation  $\alpha(x) = \theta$  has been performed, and integration by parts shows that the middle term vanishes.

---

<sup>3</sup>This sounds a bit long-winded, but is equivalent to the usual procedure for deriving a Noether current.

Similarly, we could entirely remove the original topological term, with a similar rotation  $\psi \rightarrow e^{-i\theta\gamma_5}\psi$ , however now the topological term moves into quark mass

$$Z \rightarrow \int \mathcal{D}\bar{\psi}\mathcal{D}\psi \exp \left[ i \int d^4x i\bar{\psi} (\gamma^\mu D_\mu + m e^{-2i(\theta_q+\theta)\gamma_5}) \psi \right] . \quad (4.23)$$

However we might try, we cannot remove the sum of these terms from the action, thus we should start to expect it may, in fact, be physical! This concludes the discussion of point a), where we see that although the Lagrangian may possess a symmetry, the full quantum theory may not possess this symmetry if the path integral measure is not invariant. Let us now proceed to point b).

### Totally Derivative

Eq. 4.15 may actually be written as a total derivative of a current, sometimes referred to as a Chern-Simons current

$$\mathcal{L} = \theta \frac{g^2}{32\pi^2} \epsilon^{\mu\nu\alpha\beta} G_{\mu\nu}^a G_{\alpha\beta}^a \quad (4.24)$$

$$= \theta \frac{g^2}{32\pi^2} \partial^\mu J_\mu \quad , \quad J_\mu = \epsilon_{\mu\nu\alpha\beta} \left( A_\nu^a G_{\alpha\beta}^a - \frac{2}{3} f^{abc} A_\nu^a A_\alpha^b A_\beta^c \right) . \quad (4.25)$$

Now, as total derivatives do not enter the equations of motion, we are well used to discarding them when performing calculations in perturbation theory. Indeed, if we include this term in the action we will find that at no point does  $\theta$  ever show up in the prediction for a physical process. So, from this perspective, we might be tempted to forget about it in any case.

There is, however, an important subtlety. While this reasoning is perfectly valid in perturbation theory, there may be non-perturbative field configurations at infinity that have non-trivial properties. We are familiar with these sorts of surprises from the Aharonov-Bohm effect. In that case, although a charged particle feels no force as it is taken around a solenoid, a long way from it where the magnetic field is negligible, it does pick up a phase due to the non-trivial topological structure of the field configuration.

While not, of course, exactly the same, QCD instantons are similar. These non-trivial field configurations have a finite action, as they vanish at infinity, however they do have non-trivial topology all the way out at infinity. In fact, they carry a kind of winding number, that counts the number of times the gluon field has wound around the sphere at infinity. Just as the Aharonov-Bohm phase is physical, in that it leads to measurable effects, so too are the QCD instantons. This means that although the QCD topological term is a total derivative and leads to no effects in perturbation theory, it is still physical and may show up in experiments through non-perturbative effects.

We usually consider non-perturbative effects to be small whenever perturbation theory is valid, since the non-perturbative effects tend to scale as  $\sim e^{8\pi^2/\alpha(\mu)}$ , where  $\mu$  is the relevant energy scale. When perturbation theory is under control  $\alpha \ll 1$  and these effects are exponentially small. However, when perturbation theory starts to break down,  $\alpha \sim 4\pi$ , these effects can become large. In fact, this is precisely what happens with QCD, since the gauge coupling becomes large and the non-perturbative effects are significant. In summary, when perturbation theory is breaking down, one cannot ignore the presence of total derivative operators such as eq. (4.15) in the presence of non-trivial topology.

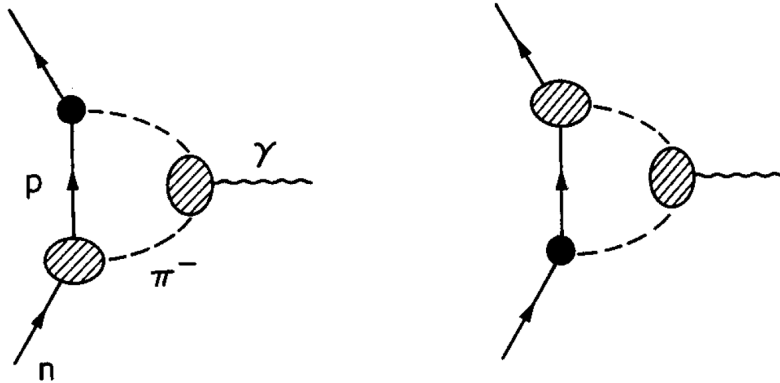

**Figure 2:** Generation of the neutron EDM from loops involving pions and the  $\eta'$  meson. Figure taken from the original CERN preprint [9].

Now, how might we observe the physical effects? As we showed in the previous section, one can entirely remove the topological term from the action by performing a chiral phase rotation that pulls the phase into the quark masses. Then, when we go to the chiral Lagrangian, which is the effective field theory that concerns QCD at low energies after quark condensation as  $\langle \bar{q}q \rangle \sim f_\pi e^{i\pi/f_\pi}$ , including the pions, and also nucleons separately, this phase shows up in the mass terms, and hence also in the interactions between fields. Loop diagrams [9], shown in fig. 2, then lead to a neutron electric dipole moment, arising from a mismatch in phases between vertices involving the pions and the  $\eta'$ .

The resulting value for the nEDM is (see e.g. [10])

$$\frac{d_n}{e} \propto -(\theta + \theta_q) \frac{m_u m_d}{(m_u + m_d)(2m_s - m_u - m_d)}. \quad (4.26)$$

Experimental constraints on the nEDM constrain the sum of phases to be  $(\theta + \theta_q) \lesssim 10^{-11}$ . Thus the sum of CP-violating angles is required to be extremely small. The strong-CP problem arises not so much because the angle is necessarily a small number, but rather that there is no good reason for it to be small. We cannot simply assume that CP is a good symmetry of nature, because we have measured that it is not in the quark sector through meson anti-meson mixing. As we know there are phases in the quark mass matrices then  $\theta_q$  should be there as well, but then how could this phase ‘know’ about  $\theta$  in such a way as to delicately cancel it?

The Strong-CP problem is clearly a very serious issue! Let’s explore some of the possible solutions.

## 4.1 Massless quark solution

This is the most minimal solution. Let me give three explanations for it:

*Poor man’s explanation:* Staring at eq. (4.26) we see that the nEDM vanishes if one of the quark masses goes to zero! Thus there is no conflict with nEDM constraints in this case.

*Less poor man’s explanation:* In eq. (4.23) we have performed a chiral rotation to move the strong-CP phase into the quark mass term. However, if  $m = 0$  then this term does not arise in the action, thus we can remove the strong-CP phase from the action with a chiral field rotation, meaning it is unphysical and will not show up in any observable.

*Rich man's explanation:* In reality, QCD interactions generate the 't Hooft determinant interaction, which looks like

$$\text{Det}[\bar{q}q] \quad (4.27)$$

for the Weyl quarks that will generate a mass for all of the quarks, thus the quarks are really massless as such. In fact, what really happens in this case is that the  $\eta'$  meson acquires a vacuum expectation value that exactly cancels the strong-CP angle.

Unfortunately, or fortunately if you share my perspective, the massless quark solution is experimentally excluded [10]. This exclusion comes from the fact that the other properties of the known mesons, including pions, require all of the quarks to have some sort of bare mass. So we must look elsewhere.

## 4.2 Spontaneous CP Breaking

If CP were a symmetry of nature then there would be no strong-CP problem. Interestingly, even though we observe CP violation in nature, we can make use of this fact if CP is truly a fundamental symmetry of nature at high energies that has been spontaneously broken, such that at low energies we don't observe it to be a symmetry. In this way, one starts with a theory that is CP-invariant and has, for example, a quark mass matrix that is entirely real. Then, CP is spontaneously broken by the vacuum expectation value of a CP-odd scalar. The interactions of this scalar may be engineered such that CP-violation shows up in the CKM matrix, but not in the strong-CP angle. In this way one has a symmetry-based explanation for the smallness of the Strong-CP angle [11–13]. (See [14] for a recent appraisal).

## 4.3 The Axion

Perhaps the favoured solution to the strong-CP problem is the axion, and so I would like to spend some time on it. It is a theorem that when a continuous global symmetry is spontaneously broken this gives rise to a massless Nambu-Goldstone boson [15, 16].

We already studied the U(1) case in sect. 2.3. There the Goldstone boson  $a$  is massless, and enjoys a shift symmetry  $a \rightarrow a + f$ . This is the 'nonlinear' realisation of the U(1) symmetry. Thus, although we often refer to symmetries as being spontaneously broken, they are really not broken at all, as the symmetry remains, however the way it acts on the relevant fields is very different. Since the radial mode is heavy we may henceforth forget about it, and just consider the field  $U = fe^{ia/f}/\sqrt{2}$ .

Now let us return to the quarks and charge them under this symmetry, such that they cannot have a bare mass term, but can only have a Yukawa interaction with the complex scalar, enforced by the U(1) symmetry. Once the scalar obtains a vev then we can see that the action for the quarks becomes

$$\mathcal{L} = i\bar{\psi}\gamma^\mu D_\mu\psi + e^{i\theta_q}\lambda\phi\bar{\psi}\psi + h.c. + \theta\frac{g^2}{32\pi^2}\epsilon_{\mu\nu\alpha\beta}G_{\mu\nu}^a G_{\alpha\beta}^a \quad (4.28)$$

$$\rightarrow i\bar{\psi}\gamma^\mu D_\mu\psi + m_\psi e^{i\theta_q+a/f}\bar{\psi}\psi + h.c. + \theta\frac{g^2}{32\pi^2}\epsilon_{\mu\nu\alpha\beta}G_{\mu\nu}^a G_{\alpha\beta}^a \quad (4.29)$$

$$\rightarrow i\bar{\psi}\gamma^\mu D_\mu\psi + m_\psi e^{i\theta_q+\theta+a/f}\bar{\psi}\psi + h.c. \quad , \quad (4.30)$$

where in the last line we performed a chiral rotation to move the QCD angle into the quark mass term, and the hermitian conjugate is just an alternative way of writing action without the  $\gamma_5$  matrix.

The important point is that the Goldstone boson enters the action in just the same way as the bare CP-violating angles. Henceforth we will refer to this field as the axion, and we will refer to this U(1) symmetry as U(1)<sub>PQ</sub>, after Roberto Peccei and Helen Quinn, who spotted that this global symmetry had very interesting implications for the strong-CP problem. Since the axion has a shift symmetry, we may happily shift away the angles  $a \rightarrow a - f(\theta_q + \theta)$  such that the action is simply

$$\mathcal{L} = i\bar{\psi}\gamma^\mu D_\mu\psi + m_\psi e^{ia/f}\bar{\psi}\psi + h.c. \quad (4.31)$$

This is, of course, relating a shift of the axion field to a quark chiral field rotation! The overall background value of the axion field  $\langle a/f \rangle$  is now the total physical strong-CP phase. For example, the neutron electric dipole moment is simply proportional to this value  $n_{EDM} \propto \langle a/f \rangle$ . What should this value be?

Let's see what happens when the quarks condense and work now within the SM. We will not include the neutral pion field, associated with the spontaneous breaking of the chiral SU(2) symmetry, however one should consult [17] for a clear and up-to-date treatment including the pions. The result in the SM for the approximation  $m_u = m_d = m_q$  is that  $m_q \langle \bar{q}q \rangle = f_\pi^2 m_\pi^2$ , thus the action becomes

$$\mathcal{L} = e^{ia/f} \langle m_\psi \bar{\psi}\psi \rangle + h.c. \quad (4.32)$$

$$\rightarrow f_\pi^2 m_\pi^2 e^{ia/f} + h.c. \quad (4.33)$$

Thus the potential generated for the axion, within QCD, is

$$V(a) = -f_\pi^2 m_\pi^2 \cos\left(\frac{a}{f}\right). \quad (4.34)$$

Note that this is a very non-trivial result. We started with a global symmetry which was spontaneously broken, leading to a massless Goldstone boson. However, this symmetry was *anomalous* at the quantum level, under QCD. This means that although in perturbation theory no mass would ever be generated for the axion, there was no obstruction to generating a mass non-perturbatively, and this is precisely what has happened: The U(1)<sub>PQ</sub> symmetry was not a true quantum symmetry of the theory, and when QCD became strongly coupled non-perturbative effects become large. Since these effects need not respect the global symmetry, they need not respect the shift symmetry of the axion, and they can, and do, generate a potential and a mass for the axion.

In addition, this potential respects a residual shift symmetry  $a/f \rightarrow a/f + n2\pi$ . This is related to the fact that there is a redundancy in the Lagrangian in the case of the global U(1) symmetry, which is that for  $e^{i\theta}$  is completely unchanged under a rotation of  $\Delta\theta = n2\pi$ . This is a discrete gauge symmetry, which is not broken, and this is showing up in the axion potential!

This potential is minimised for  $\langle a \rangle = 0$ , meaning that this field will automatically evolve to a value that predicts a vanishing neutron electric dipole moment. This solves the strong-CP problem! This solution was pointed out by Weinberg and Wilczek independently, and is

often referred to as the Weinberg-Wilczek axion. Wilczek called it the axion after a popular cleaner brand, as it cleans up the strong-CP problem. However, there is no free lunch, and although the strong-CP problem has been solved, the price of the solution is a brand new particle. A particle we should be able to observe!

#### 4.4 Axion phenomenology.

To understand how the axion behaves we need to spend some time thinking about its origin. The SM alone cannot accommodate this particle, thus there must exist a new complex scalar field somewhere and furthermore this means we need not associate  $f$  with the weak scale. To see this, consider a scenario where the quarks considered before are not the SM quarks, but actually some new quarks we have not observed yet. Then the same procedure follows as above, where the quark masses are  $m_Q = \lambda f$ , however we may perform a set of chiral rotations

$$m_Q e^{ia/f} \bar{Q} Q \rightarrow \frac{a}{f} \frac{g^2}{32\pi^2} \epsilon_{\mu\nu\alpha\beta} G_{\mu\nu}^a G_{\alpha\beta}^a \rightarrow m_q e^{ia/f} \bar{q} q \quad , \quad (4.35)$$

meaning that the axion coupling to the light SM quarks can arise even if the axion originally only coupled to some heavy quarks. This is known as the KSVZ axion [18, 19]. One can construct a similar argument using multiple Higgs doublets, known as the DFSZ axion [20, 21]. The essence being that the  $U(1)_{PQ}$  symmetry must link the axion to the light quark mass phase, but it is not really important how that is achieved. Thus, we may take  $f$  as a free parameter.

The next step is to consider the mass of the axion. This is entirely determined by  $f$ , and by expanding the cosine potential we found earlier we see that it is given by [17]

$$m_a \approx 5.7 \times 10^{-6} \text{eV} \left( \frac{10^{12} \text{GeV}}{f} \right) \quad . \quad (4.36)$$

So we see that this particle can be very light indeed. Usually we would expect to have observed all particles lighter than  $\sim \text{TeV}$  masses, however the question of observation depends on the interactions.

Since the action respects a shift symmetry on the axion  $a \rightarrow a + \kappa$ , where  $\kappa$  is a constant, we may understand all of the interactions of the axion as taking the form

$$\mathcal{L}_{Int} = \frac{c_j}{f} (\partial_\mu a) \mathcal{O}_j^\mu \quad , \quad (4.37)$$

where  $\mathcal{O}_j^\mu$  is some operator in the SM such as  $\bar{q}\gamma^\mu\gamma^5 q$ ,  $\bar{l}\gamma^\mu\gamma^5 l$ , or even a coupling to photons  $J_{EM}^\mu$  where  $\partial_\mu J_{EM}^\mu = \tilde{F}^{\mu\nu} F_{\mu\nu}$ . So in general all of the couplings are proportional to  $1/f$ , and if all of the  $c_j \sim \mathcal{O}(1)$  then for a given scattering process at an energy  $E$  the interaction strength will be proportional to  $\sim E/f$ , thus for  $E \ll f$  the interactions are extremely weak, and may evade detection.

One final comment is in order. One should not get too comfortable with assuming  $c_j \sim \mathcal{O}(1)$ . The  $c_j$  are essentially the  $U(1)_{PQ}$  charges of the relevant fields, and there is actually no technical obstruction to having hierarchical charges, so it may be that coupling strengths of radically different magnitude could show up in different microscopic models.

## Axions and stars

Interestingly, to find a heavenly particle such as the axion, one of the best places to look is the stars! The basic physics is quite simple. The axion will in general be coupled to quarks, but also typically leptons and photons. Thus, due to these couplings, scattering processes such as the Primakoff process

$$\gamma + Ze \rightarrow a + Ze \quad (4.38)$$

can lead to axion production. In the hot dense environment of a stellar core scattering processes up to energies  $E \sim \text{MeV}$ 's are copious. The next question is what would happen to these axions? If the coupling is weak enough ( $f$  is large enough), then they may entirely escape the star after production. Now, we do not search for these escaping axions from distant stars, but we may search for their indirect effects as they will carry energy out of the core of the star, leading to additional cooling of the star beyond the usual SM processes.

The effect can be observable, even for minuscule couplings, for a very simple physical reason. Electrons and photons, when produced in the inner volume of a star cannot escape the star immediately. Thus while heat transport does occur due to these process, heat loss only occurs at the surface of a star. However, if axions are produced throughout the entire volume of the star and they can escape the star unhindered, this energy loss process becomes a volume effect, rather than an area effect.

We can use this fact to make a very quick estimate of the sort of sensitivity we can expect. Let's consider the Sun. The production of axions in the volume of the star will be roughly proportional to

$$\Gamma_a \propto \left(\frac{E_a}{f}\right)^2 \times n \quad , \quad (4.39)$$

where  $n$  is the total number of particles in the star, that we will estimate to be the number of baryons. For a star like the Sun  $n \sim 10^{57}$ . For an electromagnetic effect occurring on the surface we would expect the rate to scale like

$$\Gamma_\gamma \propto 4\pi\alpha \times n^{2/3} \quad . \quad (4.40)$$

Now, for the axion effect to be detectable it should be at least comparable to the SM rate. The temperature at the core of a star is of the order  $T \sim \text{keV}$ , thus we may estimate  $E_a \sim \text{keV}$ . For these rates to be equal we see that, extremely roughly,

$$f \sim 10^5 \text{ GeV} \quad . \quad (4.41)$$

Now, this estimate was extremely crude, and if we understand an object very well we will be able to discriminate effects that are smaller than the known processes, so we should be able to do even better. Despite this gross oversimplification, we have not done too badly, since the true constraints from cooling of the Sun work out to be around  $f \sim 10^6 \text{ GeV}$ , which isn't too far off!

Stronger constraints arise from other objects. Examples include the cooling of red giant stars, or the cooling of ancient White Dwarf stars in globular clusters. These are some of the oldest stars we know of in the Universe, thus they have had a long time to cool down. Since we understand their physics relatively well, including their cooling rate and, in many cases,



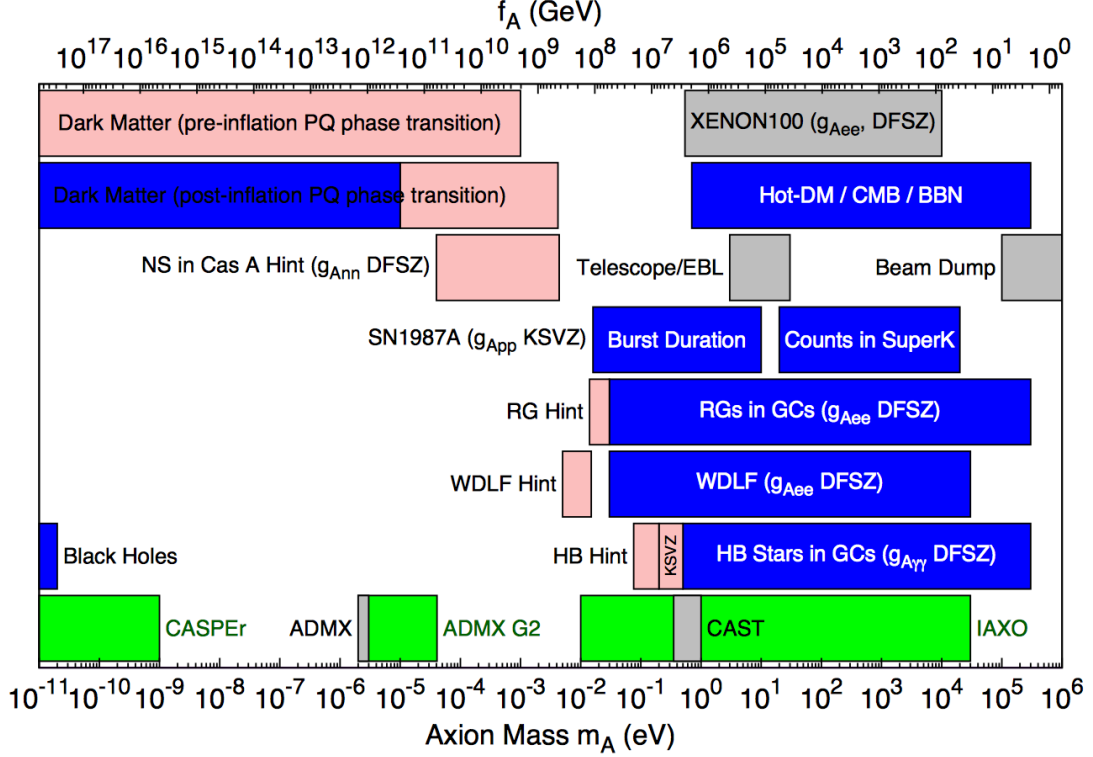

**Figure 3:** Numerous constraints and search prospects for axions, taken from [22] where an excellent overview and figure explanation may be found.

production processes, we can set strong bounds on additional cooling processes by observing populations of these stars.

The strongest bounds come from the imaginatively named SN1987A (a supernova that occurred in 1987). The physics is very neat. During a supernova there is copious neutrino production from the formation of a neutron star core  $p+e \rightarrow n+\nu$ . Even though neutrinos are weakly interacting, the medium is so dense that they do not actually escape the supernova directly, but slowly diffuse out over a period of seconds. Fortuitously, neutrino detectors on the Earth were able to observe the neutrinos from SN1987A, thus we saw this event in omnicolour (photons and neutrinos). If axions were also produced and can escape they would speed up the energy release, and thus the duration of the neutrino burst would be shorter, thus we may place constraints on axions from these extreme observations. Because the temperature is much higher in a supernova, the axion coupling is stronger, and hence we may set stronger bounds!

All of these bounds may be seen in fig. 3.

### Axion Dark Matter

The axion is already a pretty compelling candidate for BSM physics due to its elegant solution of the strong-CP problem. However, it has one more trick up its sleeve that probably makes it the most compelling BSM particle going. In an expanding Universe we may write the metric in comoving time with scale factor  $a(t)$  as  $ds^2 = dt^2 - a^2(t)dx^2$ , such that in this basis the action for a scalar field, approximating the potential with the lowest order mass

term as  $V(\phi) \approx \frac{1}{2}m^2\phi^2$ , is

$$\mathcal{L} = a^3(t) \frac{1}{2} \left( (\partial_t \phi)^2 - a^{-2}(t) \sum_i (\partial_{x_i} \phi)^2 - m^2 \phi^2 \right) . \quad (4.42)$$

The prefactor simply comes from the usual term  $\sqrt{-g}$  in GR. Assuming only time-variations for now, the equation of motion for the scalar field is

$$\partial_t (a^3(t) \partial_t \phi) - a^3(t) m^2 \phi = 0 . \quad (4.43)$$

This is why you often see the equation of motion for a scalar field in an expanding background as

$$\partial_t^2 \phi + 3H(t) \partial_t \phi = m^2 \phi , \quad (4.44)$$

where  $H(t) = (\partial_t a(t))/a(t)$ . One often sees alternative derivations of this equation, however I prefer to go straight to the EOM.

For  $m \rightarrow 0$  we see that  $\phi = \text{const}$  is a solution of this equation, thus, while  $H^2 \gg m^2$ , the scalar field will remain approximately constant, evolving very slowly along its potential. On the other hand, when  $H^2 \ll m^2$  the solution will be a standard sinusoid  $\phi \sim \sin(mt)$ . The cross-over between these two phases of evolution will occur whenever  $3H \sim m$ .

Applying this to the axion, we see that in the early Universe, even after inflation has ended, the axion field value will be approximately constant and it will not have evolved to the minimum of its potential, where it solves the strong-CP problem. Only when we satisfy  $H \sim m$  will it start to oscillate. When the oscillations begin the energy density scales, for small misalignment angles, just as for a simple harmonic oscillator, thus the oscillating axion field behaves just like cold dark matter!

## Seeing axions in the Laboratory

Axion detection is currently a very exciting field, with new ideas popping up all the time. I will sketch a selection of the experimental ideas on the table.

If the axion makes up the dark matter this means we are immersed in a background axion field that is oscillating as  $a(t) = a_0 \sin(m_a t)$ , thus the frequency of the oscillations can be described as

$$\omega \approx 2 \times 10^9 \text{Hz} \left( \frac{10^{12} \text{GeV}}{f} \right) . \quad (4.45)$$

Being bathed in this oscillating field, one could hope to detect these oscillations via an axion ‘haloscope’. There are number of different techniques. The axion-photon coupling is

$$\mathcal{L} = \frac{\alpha a}{f_{\gamma\gamma}} F^{\mu\nu} \tilde{F}_{\mu\nu} \quad (4.46)$$

$$\propto a \mathbf{E} \cdot \mathbf{B} . \quad (4.47)$$

This means that in a background magnetic field  $\langle B \rangle \neq 0$ , an axion and photon actually mix, and dark matter axions can convert into photons, that can be observed. Another set of experiments leverage the fact that, in a background magnetic field, when the axion field is oscillating it sources an oscillating electric current, that can be detected.

Since the background value of the axion field is the background value of the nEDM, one can also search for oscillating nEDMs, and a number of exciting detectors have been proposed. One can also search for the oscillating background matter field through its gravitaitonal effects.

Alternatively, one could hope to produce axions and then observe them. For example, as we have demonstrated, they can be produced copiously in the Sun, and could then convert into  $\sim$  keV photons in the laboratory. A number of experiments along these lines are known as axion ‘helioscopes’. One could also hope to detect the extremely weak force generated by the axion, such as it’s influence on spin-mediated interactions.

I have intentionally not named any detectors, since I would inevitably leave an important one out, however I will leave you with the following fig. 3, which will be discussed in detail in the lectures, for more information.

## Summary

The axion is an extremely predictive solution to a difficult problem. It has played a major role in BSM theory for decades, and will continue to do so. In these lecture notes I have not covered many other interesting aspects, such as black hole superadiance, the details of axion dark matter in cosmology and structure formation, however I hope to have provided at least a jumping off point for this exciting field of research.

## 5 The Dark Matter Problem

Dark matter is perhaps the most aggressively studied problem in BSM physics, with the number of possible models, and corresponding experimental signatures, growing rapidly each year. In the past the field was dominated by neutralino WIMPs and axion dark matter, but now we have FIMPs, SIMPs, ALPs, and much much more. The evidence for dark matter has been covered in the lectures by Laura Covi, where also the free-out production mechanism for WIMPs and their direct and indirect detection strategies, as well as the freeze-in mechanism for FIMPs, were discussed. Thus I will not commit to a lecture tailored to this topic, however one should be aware that it is a very exciting field of research where BSM meets cosmology meets table-top experiments. For the interested reader I will briefly sketch a few more aspects to this story in modern BSM. For a recent set of lectures on dark matter see [23].

One popular candidate is ALPs, which are ‘axion-like particles’ with similar properties to the axion itself, which I have already covered, however for a generic ALP the mass is a free parameter. Many searches for heavier ALPs, particularly in the keV mass range, are cosmological, looking for keV photons from ALP decay or axion-photon conversion in magnetic fields. For lighter ALPs the searches can be either laboratory based, or based on structure formation (cosmological), or even using an intriguing effect known as Black Hole Superradiance, in which the black hole can ‘spin-down’ by emitting ALPs.

Another hot topic is keV right-handed neutrinos. This is a type of FIMP. In this mass range these unstable fermions can decay, leading to signatures such as mono-chromatic photon lines. Furthermore, when this light they can behave like warm dark matter, modifying structure on small scales. At the same time, they generate Majorana neutrino masses for the left-handed neutrinos.

An incomplete, and even more brief, list of other areas under intense study in dark matter research at the moment includes

- Novel production mechanisms. Much work is dedicated to exploring scenarios in which dark matter is produced by different mechanisms. Of late the most popular has been the SIMP (strongly interacting massive particle) paradigm, however many other ideas have also been put forth.
- Novel detection strategies. A vast effort is going into finding new ways to discover ALPs, along the lines of the previous chapter, but also into searching for generic dark matter particles of all mass ranges. These strategies involve pushing direct detection to lower masses by using technologies such as semiconductors, cold molecules, and so on.
- Dark bound states. Can dark particles bind together to form a richer set of composite objects, such as dark nuclei?
- Dark matter self-interactions. There are tensions between dark matter simulations and observations, known as the ‘Too Big to Fail’ and ‘Cusp vs Core’ problems. One may solve these problems if dark matter has non-trivial self-interactions that affect dark matter halos on small scales.
- Fuzzy dark matter. For ALP dark matter structures don’t form on scales smaller than its wavelength. Thus for very light ALPs, with a wavelength comparable to small halo sizes, one may modify halo shapes.

The field of dark matter is varied and fast-moving. It is also a lot of fun as a very broad toolkit can be put to use in any given project, often requiring theoretical know-how for model-building, cosmological know-how for determining aspects such as the relic abundance or the detailed structure formation predictions, as well as an understanding of cutting-edge laboratory techniques for detecting dark matter.

## 6 The Hierarchy Problem

Let’s go back to life below 1 GeV. Working below this energy scale we observe that there are three pion degrees of freedom, packaged into a neutral pseudoscalar field  $\pi^0$  and a charged field  $\pi^\pm = \pi_1 \pm i\pi_2$ , with masses  $m_0 = 135$  MeV and  $m_\pm = 140$  MeV. Clearly they are very close in mass, so one might assume there is some symmetry that enforces their mass to be equal. In fact, it is a good idea to think of these pions to be packaged into the adjoint representation of SU(2), as  $\Pi = e^{\sum_i \pi_i \sigma_i / f_\pi}$ , where the latter are simply the Pauli matrices, and an SU(2) transformation takes  $\Pi \rightarrow U\Pi U$ , where  $U$  is a unitary  $2 \times 2$  matrix.

Now we may trivially write their mass in an explicitly symmetry-invariant manner

$$\mathcal{L}_{Mass} = \frac{1}{2}m_\pi^2 f_\pi^2 \text{Tr}\Pi \rightarrow \frac{1}{2}m_\pi^2(\pi_0^2 + \pi_1^2 + \pi_2^2) + \dots = \frac{1}{2}m_\pi^2\pi_0^2 + m_\pi^2\pi^+\pi^- + \dots \quad (6.48)$$

Let’s do a spurion analysis. The parameter  $m_\pi$  is the only spurion that breaks a shift symmetry acting on the pions, thus if we think of this as an EFT then perturbative effects

will not generate large corrections to their mass. Furthermore, this parameter respects the SU(2) symmetry, thus all quantum corrections will respect the symmetry and the pions will continue to have the same mass.

So far so good. We have a pretty decent theory for the pions. However, there is an elephant in the room. The charged pions interact with the photon through the kinetic terms

$$\mathcal{L}_{Kin} = \frac{1}{2}(\partial_\mu\pi_0)^2 + |(\partial_\mu + ieA_\mu)\pi^+|^2 \quad . \quad (6.49)$$

This interaction not only breaks the SU(2) symmetry, since it only affects the charged pions, but it also breaks their shift symmetry! Although it may look innocuous, this is not some minor modification of the theory. In fact, it *completely* destabilises the entire setup. Even without performing any calculations we know we now have a spurion parameter  $e$  that breaks these symmetries, thus if we consider this as an effective field theory, which we should, then there is absolutely nothing to forbid corrections arising at the quantum level that scale as

$$\delta\mathcal{L}_{Mass} \sim \frac{e^2}{(4\pi)^2}\Lambda^2\pi^+\pi^- \quad , \quad (6.50)$$

where the  $4\pi$  factor is typical for a quantum correction. Now we have a hierarchy problem, since if  $\Lambda \gtrsim 750$  MeV then we would have a huge puzzle, as these corrections would be greater than the observed mass splitting. How can we address this puzzle? The most obvious answer is that it must be the case that  $\Lambda \lesssim 750$  MeV. In other words there *must* be new fields and interactions that become relevant at a scale of  $E \sim 750$  MeV that will somehow tame these corrections. It turns out that nature did indeed choose this route, and in fact the  $\rho$ -meson shows up, alongside all the rest of the fields associated with QCD, and then eventually at higher energies the quarks and gluons themselves. All of this physics at the cutoff and above then explains why the pions mass splitting is what it is (see [24]). The actual correction is

$$m_{\pi^\pm}^2 - m_{\pi^0}^2 \approx \frac{3e^2}{(4\pi)^2} \frac{m_\rho^2 m_{a_1}^2}{m_\rho^2 + m_{a_1}^2} \log\left(\frac{m_{a_1}^2}{m_\rho^2}\right) \quad (6.51)$$

where  $\rho$  and  $a_1$  are the lightest vector and axial vector resonances. So this hierarchy problem is resolved very clearly in QCD. The quadratic correction from electromagnetism very much exists and is calculable. New composite resonances kick in to tame these quadratic corrections, and soon after that, above the QCD scale, the pion itself is no longer a physical state as it is a composite made up of fermions. Fermions do not receive quadratic corrections to their mass, so we can understand why the pion mass splitting is not sensitive to physics at, for example, the Planck scale!

Imagine, however, that the expected new physics had not shown up at  $E \sim 750$  MeV. What boat would we be in then? Well, we would have a huge puzzle and we would have to try and understand what is going on. We could simply add an additional parameter to our action

$$\delta\mathcal{L}_{Tune} \sim \delta_m^2 \pi^+ \pi^- \quad , \quad (6.52)$$

and then fine-tune this against the other corrections to keep the sum small, however this would seem very ad. hoc. Nature did not choose this route. Instead, nature chose for the mass splitting to be natural (= not fine-tuned). In essence, the requirement of naturalness is

satisfied precisely as we would expect from taking the measured mass splitting and turning it around to predict new fields at some energy scale!

Nowadays with the Higgs boson we are in a similar boat, except we are just working at higher energies. We have a scalar field, the Higgs. If the Lagrangian were simply the kinetic terms and its mass, then we would have no problem at all, because the mass would be the only parameter that breaks a shift symmetry for the Higgs, hence it would be stable against quantum corrections. However, we also have the gauge interactions that break any shift symmetry, just like the pions, but also more importantly the Yukawa interactions

$$\mathcal{L}_{Yukawa} = \lambda H Q U^c + h.c. \dots \quad . \quad (6.53)$$

These interactions also break the shift symmetry, where the top Yukawa is the most significant breaking term. We may thus pursue exactly the same reasoning as for the pions. At the quantum level there should arise corrections to the Higgs mass that scale as

$$\delta\mathcal{L}_{Mass} \sim 6 \frac{\lambda_t^2}{(4\pi)^2} \Lambda^2 |H|^2 \quad . \quad (6.54)$$

In natural units  $\lambda_t \approx 1$ , thus for these mass-squared corrections to remain below the EW scale we require  $\Lambda \lesssim 500$  GeV. Just as for the pions, unless some new physics kicks in around this scale we have an issue, which is that if the cutoff of the SM exceeds 500 GeV, then there must be some sort of fine-tuning taking place.

So, we see that the hierarchy problem is not some wishy-washy notion, but is in fact quite crisp and familiar. For the pions the reasoning of EFT worked beautifully, so what is going on with the Higgs? This question has pestered theorists for decades and essentially defines a strategy for understanding what physics might lurk at smaller distance scales.<sup>4</sup> In fact, a significant portion of all BSM theories so far proposed are either concerned with the hierarchy problem, or in some way framed within the context of a solution. I will now quickly sketch some of the more embryonic ideas that people are thinking about these days, before delving, in much more detail, into three paradigms for solving the hierarchy problem:

- Global symmetries
- Spacetimes symmetries
- Dynamics

This material will form the rest of these lectures.

## 6.1 Scale-Invariance

The symmetries we have encountered that relate to particle masses are shift symmetries (scalars), chiral symmetries (fermions), scale symmetries and Supersymmetry. Let us consider the scale symmetry for the pion example discussed above. If one studies the charged pion interaction with the photon

$$\mathcal{L}_{Kin} = \frac{1}{2}(\partial_\mu \pi_0)^2 + |(\partial_\mu + ieA_\mu)\pi^+|^2 \quad . \quad (6.55)$$

---

<sup>4</sup>Credit to Nathaniel Craig for emphasising that naturalness is essentially a strategy for exploring the UV.

we see that the action respects a symmetry  $x^\mu \rightarrow \alpha x^\mu$ ,  $A^\mu \rightarrow \alpha^{-1} A^\mu$ ,  $\pi^\pm \rightarrow \alpha^{-1} \pi^\pm$ . This means that while the pion-photon interaction does break the pion shift symmetry, it also respects classical scale invariance. This would then seem to imply that it alone cannot generate a mass term for the pion at the quantum level since this would break the scale symmetry. Indeed, this is true, since  $e$  carries no mass dimension. One may be tempted to conclude then that no quantum corrections to the charged pion mass can arise. However, this is clearly not true, both empirically and theoretically. The reason is that this argument only works if there are no other dimensionful parameters in the theory. However, in the SM there is the cutoff  $\Lambda \sim \text{GeV}$  above the pion mass scale, and in combination with the coupling  $e$  this generates the observed mass splitting.

Thus we see that having classical scale invariance cannot keep a scalar light if there are other high energy scales in the theory. This means that one cannot simply state that in the SM the Higgs interactions respect scale invariance, thus do not actually generate a hierarchy problem. This reasoning can only work if there are no other large dimensionful parameters in the entire theory of everything! It is a tall order indeed to find a theory in which this logic can be used to evade the hierarchy problem. Nonetheless, there are serious efforts to achieve precisely this goal (see e.g. [25]). The challenge is formidable, making this a very interesting problem. Note that while gravity itself may not generate a Higgs mass correction  $\delta m^2 \propto M_P^2$ , since this is dimensionally forbidden, in combination with SM gauge or Yukawa couplings, there is no symmetry forbidding terms such as  $\delta m^2 \propto g^2 M_P^2$ .

## 6.2 Breaking the Wilsonian Picture

The way in which we view the hierarchy problem is inherently Wilsonian. When we are talking about EFTs in high energy physics we often refer to the picture as being ‘Wilsonian’, because it was Ken Wilson who (along with Weinberg and a few others) really put the entire EFT structure on a firm footing in quantum field theories, particularly including quantum corrections [26].<sup>5</sup> This Wilsonian picture of quantum field theories is, of course, built upon the foundations of quantum field theory. Thus, if we shake the foundations, perhaps the nature of the hierarchy problem will change entirely, or even go away.

Quantum field theory has two properties fundamentally built in: Unitarity and causality. Unitarity is essentially the requirement that the sum over probabilities of all possible outcomes must equal unity. Causality is the requirement that an effect can not occur before its cause. This can occur, for example, if there are closed timelike curves, violations of the null energy condition, tachyons, ghosts, or violations of the Lorentz symmetry at high energies, and, importantly, a Hamiltonian with energy bounded from below. Now, if we were to mess with these ingredients then the Wilsonian picture can break down. For example, if causality is violated then just as there may be correlations between space-like separated events, one might hope to have correlations, or cancellations, between physics in the far UV and the IR, since spacetime invariants are related to energy-momentum invariants. If this were the case, perhaps we could understand the hierarchy problem as being solved by such a correlation.

One might naively expect something like a causality-violating theory to look very exotic, however one can write down rather sane-looking Lorentz-invariant field theories which, upon

---

<sup>5</sup>Ken Wilson was a truly remarkable human. Not only did he run a mile in less than four minutes, but he also initiated the field of lattice quantum field theory. See [27] for more on his life in physics.

closer inspection, reveal themselves to violate causality. One particularly simple example for a massless scalar field was exposed in [28]

$$\mathcal{L} = \frac{1}{2}\partial_\mu\phi\partial^\mu\phi - \frac{1}{\Lambda^4}(\partial_\mu\phi\partial^\mu\phi)^2 \quad . \quad (6.56)$$

the negative sign in the second term is in fact the cause of the acausality, and allows for superluminal propagation. Thus this theory is not actually an EFT in the Wilsonian sense, at all, although it sure looks like it at first glance! Perhaps then something similar could be true of the Standard Model, where it is not actually an EFT, so the hierarchy problem, at least as we understand it, does not even exist.

With regards to the hierarchy problem, this type of approach has a long history. The best-known example is the Lee-Wick class of theories, in which the hierarchy problem can be resolved through the presence of higher derivative operators that, upon closer inspection, can be understood as arising due to heavy ghost-like auxiliary fields. These extra fields lead to SM propagators that behave as

$$\nabla(p^2) \sim \frac{1}{p^2 - m^2} - \frac{1}{p^2 - M^2} \quad , \quad (6.57)$$

which at high energies cancel, just like in Pauli-Villars regularisation, whereas at energies  $E \ll M$ , look just like the usual SM propagators. As a result these theories cancel quadratic UV-divergences as hoped, and the price paid for outflanking Wilsonian logic is a violation of causality by the propagators with extra ‘wrong-sign’ residues. However, this is only apparent at microscopic scales.

While any theory that evades the hierarchy problem through causality violation at high energies is, presumably, likely to look like a variation of the Lee-Wick theories in some respect or another, this approach has not really been fully in the spotlight as yet, and thus there may be interesting alternatives based on this logic that may be very phenomenologically unique! We will not go into this further here, but it is worth watching this space.

### 6.3 Just input parameters.

A more trivial possibility is if the Higgs mass is not predicted in any way by the true fundamental theory. In this case it simply becomes an input parameter and it does not make sense to question its value. This is a possibility, however it would mean admitting defeat, and would essentially require that the reductionist paradigm has terminated, since this would mean that the Higgs mass *cannot be explained*. Thus, if one wishes the hierarchy problem away with this argument, the consequences for fundamental science must also be embraced. I mention this possibility here just for the sake of being comprehensive. Let us now turn to some more concrete and well known scenarios.

### 6.4 Pseudo-Goldstone Higgs

When discussing how a scalar mass might be kept small I have frequently referred to the scalar enjoying a shift symmetry. There is in fact a natural setting in which such symmetries arise, and may even be generalised beyond to non-Abelian shift symmetries that include



non-linear interactions. It is a deep and very beautiful theorem, proven by Jeffrey Goldstone and others [15, 16], that when an exact global symmetry is spontaneously broken this gives rise to massless scalar bosons. More specifically, if a global symmetry  $\mathcal{G}$  is spontaneously broken to a smaller symmetry  $\mathcal{H}$  then the theory will contain massless Nambu-Goldstone bosons living in the coset space,  $\mathcal{G}/\mathcal{H}$ .

Now, calling it a broken symmetry is actually a bit of a misnomer, because the entire symmetry  $\mathcal{G}$ , is actually always there, however in the Lagrangian we will see the remaining symmetry  $\mathcal{H}$  very explicitly as a linearly realised symmetry, with fields transforming in the usual way, whereas the symmetry for the other generators of  $\mathcal{G}$ , described by generators living in  $\mathcal{G}/\mathcal{H}$ , will actually be less apparent, and we only see it by its ‘non-linear’ action on the Goldstone bosons, which to linear order will correspond to the shift symmetry we desire.

If the global symmetry is also explicitly broken then the fields are not true Goldstone bosons, but if this explicit breaking is small then they may still be much lighter than the other scales in the theory.

With this in mind, we can see why the pions were light. In the UV theory, which is QCD, the up and down quark masses are much smaller than the strong coupling scale, and these are the only parameters that explicitly break an  $SU(2)_A$  chiral symmetry, which acts as the chiral symmetry discussed for the electron case did, but as a non-Abelian transformation acting on the up and down quarks. If we assume these mass parameters are the same, then the approximate action is

$$\mathcal{S} = - \int d^4x \left[ \mathcal{L}_{Kin} + M(\mathbf{q}_L^\dagger \cdot \mathbf{q}_R + h.c.) \right] . \quad (6.58)$$

where  $M \ll \Lambda$  and the quarks are in doublets. This action respects an  $SU(2)_V$  vector flavour symmetry  $\mathbf{q}_L \rightarrow U\mathbf{q}_L$ ,  $\mathbf{q}_R \rightarrow U\mathbf{q}_R$ , however in the limit  $M \rightarrow 0$  the symmetry is doubled to two independent symmetries  $\mathbf{q}_L \rightarrow U_L\mathbf{q}_L$ ,  $\mathbf{q}_R \rightarrow U_R\mathbf{q}_R$ . This means that the mass parameter explicitly breaks an  $SU(2)_A$  axial global symmetry. When the quarks condense due to QCD  $\langle \mathbf{q}_L^\dagger \cdot \mathbf{q}_R \rangle \propto \Lambda_{QCD}^3$  the axial symmetry is spontaneously broken  $SU(2)_A \rightarrow 0$ , hence we get  $(2^2 - 1)$  Goldstone bosons. These Goldstone bosons are the three pion degrees of freedom we have been discussing all along! When the quark masses are turned on the symmetry is explicitly broken, thus the pions become massive, however they can be *naturally* lighter than the cutoff as the quark mass is the only parameter that breaks the shift symmetry.

So the obvious question is: Could the Higgs be a Goldstone boson and even perhaps composite just like the pions? This has been an extremely active area of investigation and the answer is yes, the Higgs could be just like the pion and, just as the charged pions have gauge interactions that break their shift symmetry, so too can a pseudo-Goldstone Higgs boson. The top quark interactions which explicitly break the global symmetry, and hence the shift symmetry, are very large however, so some work is required to have them not lead to very large Higgs mass corrections.

Let’s see how this goes. Since the Higgs is not massless it is not really a Goldstone, but a pseudo-Goldstone boson, just like the pions, thus I will refer to models of this class as pNGB Higgs models, (pseudo-Nambu-Goldstone boson Higgs). The main classes of models of this class are composite Higgs models (just like pions), Little Higgs models (similar technology, but with machinery that can protect the Higgs mass to higher loop orders), and the recently popular Twin Higgs models. In the next section I will sketch the main ideas common to

composite and Little Higgs models. However, if you wish to know more the lectures by Contino [29] not only beautifully explain the field theory behind composite Higgs models, but also present the types of models more commonly considered for vanilla composite Higgs scenarios. The review by Schmaltz and Tucker-Smith on the Little Higgs models is a superb starting point for these models [30].

### pNGB Higgs

The basic recipe is the following. Let us take some symmetry  $\mathcal{G}$  with a gauged subgroup  $\tilde{\mathcal{G}}$ , spontaneously broken to  $\mathcal{H}$  with a gauged subgroup  $\tilde{\mathcal{H}}$ . Now, we have  $N_G = \dim(\mathcal{G}) - \dim(\mathcal{H})$  Goldstone bosons, of which  $N_g = \dim(\tilde{\mathcal{G}}) - \dim(\tilde{\mathcal{H}})$  are eaten by the gauge bosons, leaving  $N = N_G - N_g$  massless scalars at tree-level.

Thus we see that in order to fit a Higgs doublet into this concoction we must have at least  $N \geq 4$  and  $\tilde{\mathcal{H}} \supset \text{SU}(2) \times \text{U}(1)$ . A great deal of effort has gone into enumerating the possibilities, but let us study the absolute simplest one. This model has  $\mathcal{G} = \text{SU}(3)$ ,  $\mathcal{H} = \tilde{\mathcal{H}} = \text{SU}(2)$ , thus the number of Goldstone bosons is  $N = 8 - 3 = 5$ . This model in fact does not respect custodial symmetry, which means that the dangerous operator

$$\mathcal{O}_T = \frac{1}{\Lambda^2} (H^\dagger D_\mu H)^2 \quad (6.59)$$

that modifies the SM prediction for the W to Z-boson mass ratio can be generated by the physics at the UV, so this model is actually very much disfavoured by the precision LEP measurements. Nonetheless, this model is so simple that it serves well as a straw man for pNGB scenarios, so we will study it here.

The low energy dynamics of the pNGBs are described in full generality by the CCWZ construction [31, 32], that I encourage you to read, however for these lectures it suffices that we may capture the relevant operators by considering what is generally known as a non-linear sigma model, with the field parameterisation

$$\Sigma = e^{i\Pi/f} \Sigma_0, \quad \Pi = \pi^a T^a, \quad (6.60)$$

where  $\pi^a$  are the pNGBs,  $T^a$  are the broken generators of  $G$ , and  $\langle \Sigma \rangle = |\Sigma_0| = f$ . The global symmetry breaking is induced by a scalar field,  $\Sigma$ , transforming as a  $\mathbf{3}$  under  $\text{SU}(3)$ , which acquires a vacuum expectation value  $\Sigma_0 = (0, 0, f)$ . The pNGBs can thus be parameterized by the non-linear sigma field as in Eq. (6.60), with

$$\Pi = \pi^a T^a = \begin{pmatrix} 0 & 0 & h_1 \\ 0 & 0 & h_2 \\ h_1^\dagger & h_2^\dagger & 0 \end{pmatrix} + \dots, \quad (6.61)$$

with  $T^a$  the broken generators of  $\text{SU}(3)_W$  and we have not included the additional singlet pNGB corresponding to the diagonal generator. We may write the sigma field explicitly as

$$\Sigma = \begin{pmatrix} i h_1 \frac{\sin(|h|/f)}{|h|/f} \\ i h_2 \frac{\sin(|h|/f)}{|h|/f} \\ f \cos(|h|/f) \end{pmatrix}, \quad (6.62)$$

where  $|h| \equiv \sqrt{h^\dagger h}$ .

## Gauge Interactions

The gauge interactions can be added in the usual way. If we wish, we can add them in an SU(3)-invariant manner, with the covariant derivative

$$D_\mu \Sigma \quad , \quad D_\mu = \partial_\mu + ig \sum_a W_\mu^a \lambda^a \quad , \quad (6.63)$$

where  $\lambda^a$  are the SU(3) generators. Then we simply set all but the SU(2) gauge fields to zero. Note that after electroweak symmetry breaking the interaction strength of the physical Higgs boson with the SM gauge fields is suppressed by a factor

$$\frac{\sin(v/f)}{v/f} \approx 1 - \frac{1}{6} \left( \frac{v^2}{f^2} \right)^2 \quad , \quad (6.64)$$

thus we can test a pNGB scenario like this by looking for modified Higgs interactions!

Gauging a subgroup of the full global symmetry is an explicit breaking of the global symmetry, thus the pNGB Higgs mass is not protected against quadratic corrections in the gauge sector. Indeed, in analogy with the pion mass corrections from before, at one loop gauge interactions will generate a Higgs mass-squared proportional to

$$\delta m_h^2 \sim \frac{g^2}{16\pi^2} \Lambda^2 \quad (6.65)$$

where  $\Lambda$  is the UV cutoff. In a pNGB model where this is the full story then one must follow calculations such as for the pion mass splitting, which include a priori unknown form factors, in order to estimate the correct magnitude of the correction. Note that in order for these corrections not to be too large one requires that the cutoff is not too far away, and thus the full-blown dynamics of the composite sector, including heavy vector mesons, should/could be accessible at the LHC.

We may also employ additional tricks to suppress these corrections. Imagine we didn't switch off the additional gauge bosons. Then we would have the full SU(3) symmetry, however we wouldn't have any leftover Goldstone bosons to play the role of the Higgs doublet. Then let us instead take two separate  $\Sigma$  fields, each with their own SU(3) global symmetry, but we gauge the diagonal combination of these symmetries, such that both fields are charged under the SU(3) gauge symmetry. When both fields get a vev we get two sets of SU(3)/SU(2) Goldstone bosons. One set is eaten, but the other set remains light. Since the original theory was written in a fully SU(3)-invariant manner, no quadratic divergences arise. At worst, at one loop the gauge interactions will induce dangerous interactions such as  $(\Sigma_1 \cdot \Sigma_2)^2$ , but this is suppressed by a loop factor, such that the resulting correction to the Higgs mass is

$$\delta m^2 \sim \frac{g^4}{16\pi^2} \log \left( \frac{\Lambda^2}{\mu^2} \right) f^2 \quad (6.66)$$

which is significantly smaller than the correction in the simplest model! This is the essence of the Little-Higgs trick for the gauge sector, and it can be extended to a greater number of symmetries to further suppress these corrections.

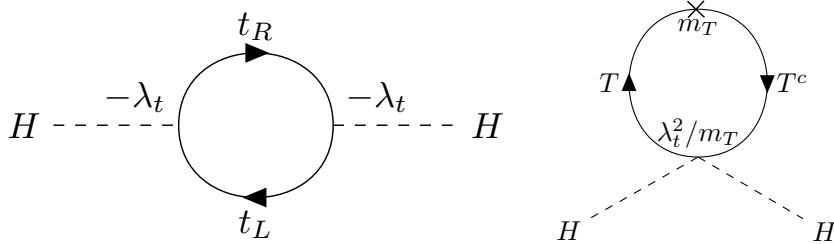

**Figure 4:** The cancellation between quadratic divergences from the top quark loop and fermionic top-partner loops.

## Top Quark Interactions

We must also add the top quark Yukawa. The simplest way to do this is to work in analogy with the gauge sector. With the gauge sector we start with a full  $SU(3)$  gauge multiplet, and set some fields to zero, which explicitly breaks the symmetry. Here we may do the same, by introducing the incomplete  $SU(3)$  quark multiplet  $Q = (t, b, 0)$ , alongside the usual right-handed top  $t_R$ . Then the Yukawa interaction can be written in an  $SU(3)$ -invariant manner

$$\mathcal{L}_\lambda = \lambda_t Q \cdot \Sigma t_R \quad (6.67)$$

Of course, just as with the gauge sector, at one loop a quadratically divergent Higgs mass correction will be generated

$$\delta m^2 \sim \frac{3\lambda_t^2}{16\pi^2} \Lambda^2 \quad (6.68)$$

One may wish to simply tolerate this, and thus place strong limits on how large  $\Lambda$  can be for the solution to the hierarchy problem to really hold. Other options include adding ‘top partner fields’. For composite Higgs scenarios there are numerous possibilities, thus I refer the interested reader to [33] for an overview. Let me just sketch a basic example showing how these extra fields may cancel quadratic divergences.

Let us really make the interaction  $SU(3)$ -invariant by putting the missing field back in  $Q = (t, b, T)$ , and also add a little bit of explicit breaking of  $SU(3)$  by coupling  $T$  to a conjugate fermion to give it a Dirac mass  $M_T \ll \Lambda$ . Thus we have

$$\mathcal{L}_\lambda = \lambda_t Q \cdot \Sigma t_R + M_T T^c T \quad (6.69)$$

where now the SM right-handed top quark will in general be a linear combination of  $t_R$  and  $T_c$ . At high energies  $M_T$  is just a small perturbation, and the Yukawa is fully  $SU(3)$  symmetric, thus based on symmetry reasons alone the largest quadratic correction we can generate for the Higgs mass can at most be of the order

$$\delta m^2 \sim \frac{3\lambda_t^2}{16\pi^2} M_T^2 \quad (6.70)$$

If  $M_T \ll \Lambda$  then we have tamed, to some degree, the quadratic corrections to the Higgs from the top sector. One can show that this setup leads to a diagrammatic cancellation of the form shown in fig. 4. However, we now have an additional coloured fermion that we can search for at the LHC.

## Summary

This concludes a summary of the basic features of pNGB Higgs models. The details are much more involved than I have sketched here, however these basic building blocks should provide enough coverage to delve into the literature!

## Twin Higgs

At its heart the Twin Higgs [34] is a pNGB Higgs model. One begins with a scalar multiplet  $H$  transforming as a fundamental under a global  $SU(4)$  symmetry. The renormalizable potential for this theory is

$$V = -m^2|H|^2 + \frac{\lambda}{2}|H|^4 \quad (6.71)$$

where we have intentionally written a negative mass-squared. In the vacuum the global symmetry breaking pattern is  $SU(4) \rightarrow SU(3)$ , thus irrespective of the magnitude of  $m$  there will exist 7 massless Goldstone bosons. It is important to keep in mind that  $m$  could be very large and in a theory with new physics scales,  $m^2$  will contain all of the perturbative divergent contributions. For example, if there are new states of mass  $\Lambda$  we expect contributions  $m^2 \sim \text{loop} \times \Lambda^2$ . This does not introduce additional quadratic divergences to the mass of the Goldstone bosons since these contributions are  $SU(4)$  symmetric and thus the Goldstone boson masses are still protected by Goldstone's theorem.

Let us break up  $H$  into a representation of  $SU(2)_A \times SU(2)_B \subset SU(4)$  as

$$H = \begin{pmatrix} H_A \\ H_B \end{pmatrix} . \quad (6.72)$$

We may rewrite eq. (6.71) as

$$V = -m^2 (|H_A|^2 + |H_B|^2) + \frac{\lambda}{2} (|H_A|^2 + |H_B|^2)^2 , \quad (6.73)$$

which is precisely the same as eq. (6.71), but written in a different manner. We may also write this as

$$V = \frac{\lambda}{2} (|H_A|^2 + |H_B|^2 - f^2)^2 . \quad (6.74)$$

## Gauge Interactions

We now augment the theory by gauging the two  $SU(2)_A \times SU(2)_B$  subgroups. If the vacuum expectation value for  $H$  lies completely in the  $H_B$  field then the three Goldstone bosons from  $H_B$  will be eaten by the  $SU(2)_B$  gauge bosons, to become their massive longitudinal components. The four Goldstone bosons from  $H_A$  will remain uneaten because the off-diagonal gauge bosons of  $SU(4)$  which would have eaten these degrees of freedom were explicitly removed from the theory when we chose not to gauge the full  $SU(4)$  symmetry. Thus we have four light scalars charged under the unbroken  $SU(2)_A$  gauge symmetry. It is apparent that if  $SU(2)_A$  could be identified with the SM weak gauge group, and if  $H_A$  could be identified with the SM Higgs doublet, then we have a candidate solution of the hierarchy problem! However there are some further complications which must first be overcome.

The first point to note is that by coupling the scalars to gauge bosons we have introduced a new source of quadratic divergences. Regularising the theory with a cutoff  $\Lambda$  we generate terms such as

$$V \sim \frac{g_A^2}{16\pi^2} \Lambda_a^2 |H_A|^2 + \frac{g_B^2}{16\pi^2} \Lambda_b^2 |H_B|^2 \quad , \quad (6.75)$$

where as yet there is no reason to believe the effective cutoff is the same for each field. However, if we impose an exchange symmetry on the entire theory  $A \leftrightarrow B$  then  $g_A = g_B$ , and assume the UV physics respects this exchange symmetry, such that  $\Lambda_a = \Lambda_b$ , then the contributions in eq. (6.75) are equal. Furthermore, because they are equal they respect the SU(4) symmetry, thus they do not actually introduce any new quadratically divergent contributions to the Goldstone boson masses. Hence these dangerous contributions have been ameliorated by a combination of Goldstone's theorem and the fact that an exchange symmetry accidentally enforces an SU(4)-invariant structure on the quadratic part of the action. This is worth reemphasising: quadratic divergences have not been removed from the theory, but the sensitivity of the Goldstone boson masses to those divergences has been removed by Goldstone's theorem.

Unfortunately at the level of the quartic couplings the picture is not as clean. The scalar quartic couplings will run logarithmically due to the gauge interactions. This running must only respect the exchange symmetry and the  $SU(2)_A \times SU(2)_B$  symmetry, but not necessarily the full SU(4) symmetry. In practice, even if we enforce an SU(4) symmetric scalar potential in eq. (6.74) at a scale  $\Lambda$ , at the lower scale of symmetry breaking  $m$  we expect additional contributions to the effective potential

$$V_{BR} \sim \frac{g_A^4}{16\pi^2} \log\left(\frac{m}{\Lambda_a}\right) |H_A|^4 + \frac{g_B^4}{16\pi^2} \log\left(\frac{m}{\Lambda_b}\right) |H_B|^4 \quad . \quad (6.76)$$

Even when we impose the exchange symmetry,  $g_A = g_B$ ,  $\Lambda_a = \Lambda_b$ , these terms explicitly break the SU(4) symmetry, thus they will in general lead to a non-zero mass-squared for the now pseudo-Goldstone bosons

$$m_{PNG}^2 \propto \frac{g_A^4}{16\pi^2} m^2 \log\left(\frac{m}{\Lambda}\right) \quad . \quad (6.77)$$

This tells us that in this theory we may only hope to have a loop factor in the hierarchy  $m_h^2 \sim \frac{g_A^4}{16\pi^2} m^2$ , and, as  $m$  is quadratically sensitive to the cutoff, a loop factor in the hierarchy  $m^2 \sim \frac{g_A^2}{16\pi^2} \Lambda^2$ . In the end of the day with this mechanism we expect the cutoff scale of the full theory to be an electroweak loop factor above the weak scale, demonstrating that the Twin Higgs can only be a solution to the little hierarchy problem and to solve the full hierarchy problem this theory must be UV-completed.

A final issue is that the theory presented above respects the exchange symmetry  $A \leftrightarrow B$ . This implies that the vacuum will also respect this symmetry, with  $v_A = v_B$ . Amongst other things, this predicts that the SM Higgs boson would be a perfect admixture of  $H_A$  and  $H_B$  and would couple to the SM gauge bosons with a suppression factor  $\cos \theta_{AB} = 1/\sqrt{2}$ . Clearly this is at odds with observations. To resolve this issue we can, for example, introduce a small soft symmetry breaking term

$$V_{SB} = -m_B^2 |H_B|^2 \quad . \quad (6.78)$$

This term explicitly breaks the global symmetry and even the exchange symmetry. It is important to note that since  $m_B$  breaks the exchange symmetry it may be small in a technically natural manner. Even though the Goldstone bosons have obtained mass from this operator, this mass is insensitive to the cutoff and can be naturally small:  $m_{GB} \ll \Lambda$ , where  $\Lambda$  can be interpreted as the cutoff of the theory. Importantly, this exchange symmetry breaking can align most of the vacuum expectation value into the  $B$  sector, realising  $v_A \ll v_B$ . This will suppress the Higgs mixing with the other neutral scalars and will also allow a hierarchical structure  $v_A \ll v_B \ll \Lambda$ , at the cost of a tuning comparable to  $v_B^2/v_A^2$ .

### Yukawa Interactions

As far as the scalar fields and the gauge interactions are concerned, this is essentially all that is required of the Twin Higgs model. Hypercharge may be trivially included in this picture. The last step is to couple the SM Higgs to fermions. If we add Yukawa couplings of  $H_A$  to fermions, for example the up quarks, as

$$\mathcal{L} \supset \lambda_A H_A Q_A U_A^c \quad , \quad (6.79)$$

then we see an immediate problem. The top quark loops lead to SU(4)-violating quadratic divergences

$$m_A^2 \propto \frac{\lambda_t^2}{16\pi^2} \Lambda^2 \quad (6.80)$$

and the solution has been destroyed. However, the resolution is immediately apparent. We enforce the exchange symmetry  $A \leftrightarrow B$  by introducing Twin quarks with identical couplings, such that the Yukawa couplings are now

$$\mathcal{L} \supset \lambda_A H_A Q_A U_A^c + \lambda_B H_B Q_B U_B^c \quad (6.81)$$

and the quadratic divergences are once again SU(4)-symmetric

$$V \sim \frac{\lambda_A^2}{16\pi^2} \Lambda_A^2 |H_A|^2 + \frac{\lambda_B^2}{16\pi^2} \Lambda_B^2 |H_B|^2 \quad , \quad (6.82)$$

since  $\lambda_A = \lambda_B$  and  $\Lambda_A = \Lambda_B$ . Thus the theory at the scale  $\Lambda$  is approximately SU(4) symmetric and the SM Higgs boson is realised as a pseudo-Goldstone boson of spontaneous global symmetry breaking. This renders the Higgs boson naturally lighter than the UV cutoff of the theory,  $m_h \ll \Lambda$ .

We can also see that if the Twin symmetry is imposed for all degrees of freedom, including gluons and leptons, then at any loop order the Higgs mass will still be free of quadratic sensitivity to the cutoff. This is the essence of the Twin Higgs mechanism which, in the simplest incarnation, requires an *entire copy of the SM* which is completely neutral under the SM gauge group, but with its own identical gauge groups. The only communication between the SM and the Twin Sector is through the Higgs boson. This is depicted in fig. ??.

The presentation of the Twin Higgs mechanism may appear somewhat backwards and a little laborious in comparison to other possible presentations. This has been intentional, in the hope that it may anticipate a potential misconception for those not familiar with Twin Higgs model. It is sometimes considered that it is seemingly ad hoc or arbitrary to add an

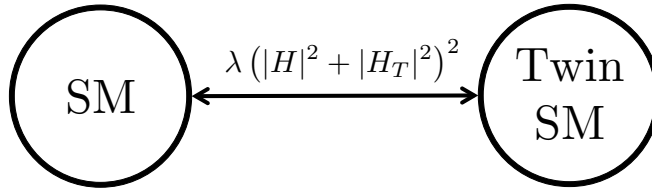

**Figure 5:** The structure of the Twin Higgs model. The SM and an entire copy are symmetric under a complete exchange of all fields. This ensures that the quadratic scalar action respects an accidental  $SU(4)$  symmetry, of which the SM Higgs is a pNGB. All interactions between the SM and Twin SM are through this single Higgs potential term.

entire copy of the SM for the Twin Higgs mechanism to work. Hopefully this section has made it clear that there is nothing arbitrary about the introduction of the new fields. The mechanism is not justified by adding an entire copy of the SM and then proving a diagram-by-diagram, and loop-by-loop, cancellation of quadratic divergences. Rather, the new fields are introduced in order to realise an exchange symmetry  $A \leftrightarrow B$ . The exchange symmetry ensures that at the quantum level the quadratic part of the scalar potential respects an accidental  $SU(4)$  symmetry, even with quadratic divergences included. The observed Higgs boson mass is insensitive to this  $SU(4)$ -symmetric quadratic divergence because it is a pseudo-Goldstone boson of spontaneous  $SU(4)$  breaking.<sup>6</sup>

## Phenomenology

Unlike in standard composite Higgs models, where the copious production of new coloured particles at the LHC is a generic prediction, the collider signatures of the Twin Higgs are thin on the ground. In both theories a key prediction is the existence of so-called ‘top partners’ which regulate the quadratically divergent top quark loops contributing to the Higgs mass-squared. In the Twin Higgs these are fermions charged under Twin QCD<sub>T</sub> but not under SM QCD. They are in fact the first known example of a theory with the moniker “Neutral Naturalness”, used to describe theories in which the top-partners are not charged under QCD. This drastically suppresses top-partner production at the LHC since the only coupling to the SM is through the Higgs and any top-partner production must go through an off-shell Higgs boson. The most promising approaches to test the Twin Higgs lie elsewhere.

One very robust prediction of the Twin Higgs scenario is a universal suppression of Higgs couplings to SM states. The reason for this is that the Higgs bosons from both sectors,  $h_A$  and  $h_B$ , have a mass mixing controlled by the hierarchy of vevs  $v_A^2/v_B^2$ . As  $h_B$  is a SM singlet this is equivalent to the usual “Higgs Portal” mixing scenario where all Higgs couplings are diluted by a factor  $\cos\theta$ . This mixing may be constrained by searching for an overall reduction in Higgs signal strengths at the LHC and, since the ratio  $v_A^2/v_B^2$  is a driving indicator of the tuning in the theory, Higgs measurements directly probe the tuning of the Twin Higgs scenario. In fact, one-loop LEP constraints on modified Higgs couplings already push this tuning to the  $\sim 10 - 20\%$  level [36].

Another possibility is that due to the Higgs Portal mixing the heavy Higgs boson may be

---

<sup>6</sup>It is also possible to see a diagram-by-diagram cancellation of quadratic divergences rather than relying on the symmetry-based argument here, however this is less illuminating.



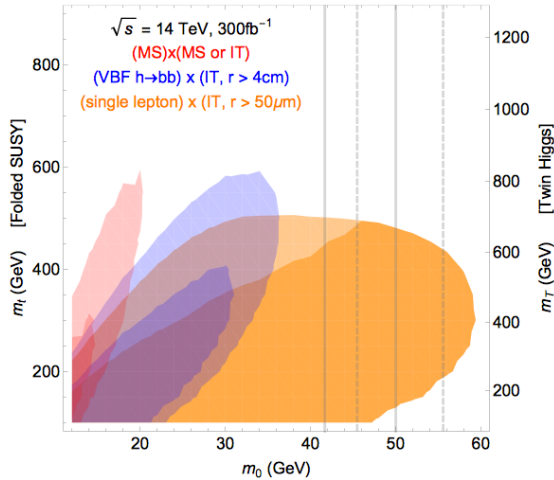

**Figure 6:** Expected collider limits on the parameter space of the Twin Higgs model (far right axes) from constraints on exotic Higgs decays. Figure taken from [35].

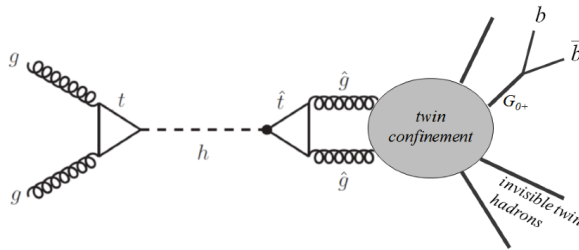

**Figure 7:** Twin glueball production and decay through the Higgs portal. Figure taken from [40].

singly produced at the LHC and it could decay in SM states with signatures, but not signal strengths, identical to a heavy SM Higgs boson. It may also decay to pairs of Higgs bosons, leading to resonant di-Higgs production.

More exotic signatures arise once the Twin sector is considered in full. If Twin sector states are produced through the Higgs Portal they may decay into lighter Twin sector states, eventually cascading down to the lightest states within the Twin sector. These lightest states may then decay back into SM states, leading to a huge variety of exotic signatures. In essence, the Twin Higgs scenario provides a framework in which many so-called ‘hidden valley’ signatures [37–39] may be realised. As the motivation comes from the hierarchy problem, it is necessary that the new states must lie within some proximity to the weak scale. Taking naturalness as a guide there are many possibilities for the spectrum in the Twin sector since it is possible that the lighter states which are less relevant for Higgs naturalness may have modified couplings to the Twin Higgs or may even not exist in the theory.

A particularly interesting example is for exotic Higgs decays into Twin glueballs, as depicted in fig. 7. This is possible because the Higgs couples to the Twin Top quarks, leading (at one loop) to a coupling to Twin gluons. The Higgs may thus decay to the Twin glueballs, which then decay back through an off-shell Higgs to SM states, including bottom quarks. Such an exotic Higgs decay signature can be used to search for the Twin sector

states. The expected reach for scenarios like this, taken from [35], is shown in fig. 6.

## 6.5 Supersymmetry

In the last section we saw that a Higgs mass well below the cutoff can be explained if the Higgs is a Goldstone boson of a spontaneously broken global symmetry, but what about spacetime symmetries? In 1967 Coleman and Mandula proved that it is impossible to combine the Poincaré and internal symmetries in any but a trivial way. Intriguingly, this proof only applied to Lorentz scalar, i.e. bosonic, internal symmetries, and in 1975 Haag, Lopuszanski, and Sohnius showed that, in addition to internal and Poincaré symmetries, it is possible to extend the Poincaré symmetry to include spin-1/2 generators in a consistent quantum field theory. This extension is known as supersymmetry. See [41–43] for standard texts on SUSY.

Any continuous symmetry has generators, and as with global symmetries, the supersymmetry generators must commute with the Hamiltonian, and convert fermionic states to bosonic states, and vice-versa. We call the SUSY generators  $Q_\alpha$  ( $\alpha = 1, 2$ ) and their complex conjugate  $\bar{Q}_{\dot{\alpha}}$  ( $\dot{\alpha} = \dot{1}, \dot{2}$ ). These are spinor quantities, and obey the commutation and anti-commutation relations

$$[P^\mu, Q_\alpha] = [P^\mu, \bar{Q}_{\dot{\alpha}}] = 0 \quad (6.83)$$

$$\{Q_\alpha, Q_\beta\} = \{\bar{Q}_{\dot{\alpha}}, \bar{Q}_{\dot{\beta}}\} = 0 \quad (6.84)$$

$$\{Q_\alpha, \bar{Q}_{\dot{\beta}}\} = 2\sigma_{\alpha\dot{\beta}}^\mu P_\mu \quad (6.85)$$

where  $P^\mu$  is the usual generator of translations,  $\partial_\mu$ . I have shown only the commutation and anti-commutation relations for one set of supercharges, e.g.  $\mathcal{N} = 1$  SUSY, however it is straightforward to generalise these relations to more supercharges. I will continue to focus on the case of  $\mathcal{N} = 1$  SUSY throughout this section. As these generators change the spin of a state by a unit of 1/2, one would expect that in a supersymmetric theory states come with some sort of ‘multiplet’ structure, in which there is a state of spin  $S$  and a state of spin  $S + 1/2$ , where  $S = 0, 1/2$  for a renormalizable theory. These multiplets are called ‘supermultiplets’, and we will now consider how they are constructed.

In order to begin constructing such multiplets it is instructive to begin by considering the supersymmetry algebra as a graded Lie algebra. By extending the analogy with space-time translations, we define the group element

$$G(x, \theta, \bar{\theta}) = e^{-i(x_\mu P^\mu - \theta Q - \bar{\theta} \bar{Q})} \quad , \quad (6.86)$$

where  $\theta$  and  $\bar{\theta}$  are anti-commuting parameters. Now, using Hausdorff’s formula one can show that under a transformation with parameters  $\{x, \theta, \bar{\theta}\}$  followed by a SUSY transformation with parameters  $\{\zeta, \bar{\zeta}\}$  we have the set of transformations

$$x^\mu \rightarrow x^\mu + i\theta\sigma^\mu\bar{\zeta} - i\zeta\sigma^\mu\bar{\theta} \quad (6.87)$$

$$\theta \rightarrow \theta + \zeta \quad (6.88)$$

$$\bar{\theta} \rightarrow \bar{\theta} + \bar{\zeta} \quad . \quad (6.89)$$

This transformation in parameter space can be generated by the differential operators  $Q$  and  $\bar{Q}$

$$\zeta Q + \bar{\zeta} \bar{Q} = \zeta^\alpha \left( \frac{\partial}{\partial \theta^\alpha} - i \sigma_{\alpha\dot{\alpha}}^\mu \bar{\theta}^{\dot{\alpha}} \partial_\mu \right) + \bar{\zeta}_{\dot{\alpha}} \left( \frac{\partial}{\partial \bar{\theta}^{\dot{\alpha}}} - i \theta^\alpha \sigma_{\alpha\dot{\beta}}^\mu \epsilon^{\dot{\beta}\dot{\alpha}} \partial_\mu \right) . \quad (6.90)$$

Again, by analogy with fields which are functions of space-time co-ordinates, we can define a superfield as a field which is a function of the co-ordinates  $\{x, \theta, \bar{\theta}\}$ . Henceforth we will write superfields in bold font, and their component fields in plain font. As  $\theta$  and  $\bar{\theta}$  are Grassmann parameters, the Taylor expansion of a superfield in these co-ordinates terminates as, e.g.  $\theta_1 \theta_1 = 0$ . Thus, calling our superfield  $\mathbf{F}(x, \theta, \bar{\theta})$ , and expanding in the Grassmann parameters, we have

$$\begin{aligned} \mathbf{F}(x, \theta, \bar{\theta}) = & f(x) + \theta \phi(x) + \bar{\theta} \bar{\chi}(x) + \theta \theta m(x) + \bar{\theta} \bar{\theta} n(x) + \theta \sigma^\mu \bar{\theta} v_\mu(x) \\ & + \theta \theta \bar{\theta} \bar{\lambda}(x) + \bar{\theta} \bar{\theta} \theta \psi(x) + \theta \theta \bar{\theta} \bar{\theta} d(x) \end{aligned} \quad (6.91)$$

which transforms under a SUSY transformation as

$$\delta_\zeta \mathbf{F}(x, \theta, \bar{\theta}) \equiv (\zeta Q + \bar{\zeta} \bar{Q}) \mathbf{F} . \quad (6.92)$$

By comparing individual powers of  $\theta$  after applying the SUSY transformation of eq.(6.92) we can determine how the individual fields transform. Also, as the Taylor expansion in  $\theta$  terminates, we can see that the product of two, or more, superfields must itself be a superfield, where the individual component fields are products of component fields of the original ‘fundamental’ superfields.

Now we have a linear representation of the SUSY algebra, however, this representation can be reduced. We define a chiral superfield,  $\Phi$ , by the constraint  $\bar{D}_{\dot{\alpha}} \Phi = 0$ , where  $\bar{D}_{\dot{\alpha}} = -\partial/\partial \bar{\theta}^{\dot{\alpha}} - i \theta^\alpha \sigma_{\alpha\dot{\alpha}}^\mu \partial_\mu$ . Thus our chiral superfield takes the form

$$\begin{aligned} \Phi(x, \theta) = & A(x) + i \theta \sigma^\mu \bar{\theta} \partial_\mu(x) A(x) + \frac{1}{4} \theta \theta \bar{\theta} \bar{\theta} \partial_\mu \partial^\mu A(x) \\ & + \sqrt{2} \theta \psi(x) + \frac{i}{\sqrt{2}} \theta \theta \partial_\mu \psi \sigma^\mu \bar{\theta} + \theta \theta F(x) \end{aligned} \quad (6.93)$$

and an anti-chiral superfield takes a similar form, following from  $D_\alpha \Phi^\dagger = 0$ .

The components of the superfield in eq.(6.93) transform under SUSY transformations as

$$\delta_\zeta A = \sqrt{2} \zeta \psi \quad (6.94)$$

$$\delta_\zeta \psi = i \sqrt{2} \sigma^\mu \bar{\zeta} \partial_\mu A + \sqrt{2} \zeta F \quad (6.95)$$

$$\delta_\zeta F = i \sqrt{2} \bar{\zeta} \bar{\sigma}^\mu \partial_\mu \psi . \quad (6.96)$$

From these transformations we see that the  $F$ -term transforms into a total derivative. If all fields vanish at infinity then the  $F$ -term of a chiral superfield thus forms a SUSY-invariant Lagrangian term. It follows that the  $F$ -term of any product of chiral superfields is a SUSY-invariant Lagrangian term. In addition, the  $\theta^2 \bar{\theta}^2$  term in  $\Phi^\dagger \Phi$  also transforms into a total derivative. This term is then also a candidate for a SUSY-invariant term in the Lagrangian, and is given in component form as

$$\begin{aligned} \Phi^\dagger \Phi|_{\bar{\theta}^2 \theta^2} = & F^* F + \frac{1}{4} A^* \partial^2 A + \frac{1}{4} \partial^2 A^* A - \frac{1}{2} \partial_\mu A^* \partial^\mu A \\ & + \frac{i}{2} \partial_\mu \bar{\psi} \bar{\sigma}^\mu \psi - \frac{i}{2} \bar{\psi} \bar{\sigma}^\mu \partial_\mu \psi \end{aligned} \quad (6.97)$$

clearly giving the kinetic terms for the individual component fields.

Thus we are in a position to construct a SUSY-invariant theory with chiral superfields. We can introduce one further ingredient which simplifies notation. Defining  $\int d\theta = 0$  and  $\int \theta d\theta = 1$ , then we can write our supersymmetric Lagrangian as

$$\mathcal{L} = \int d^2\bar{\theta}d^2\theta\Phi_i^\dagger\Phi_i + \left[ \int d^2\theta(f_i\Phi_i + m_{ij}\Phi_i\Phi_j + \lambda_{ijk}\Phi_i\Phi_j\Phi_k) + \text{h.c.} \right] , \quad (6.98)$$

where the first term is usually referred to as the Kähler potential,  $K$ , and the second term is the Superpotential,  $W$ . The former picks up the  $\theta^2\bar{\theta}^2$  term in  $K$ , and the latter the  $\theta^2$  term in  $W$ .

We can re-write this Lagrangian as

$$\mathcal{L} = \int d^2\bar{\theta}d^2\theta K(\Phi_i^\dagger, \Phi_i) + \int d^2\theta W(\Phi_i) + \int d^2\bar{\theta}W^*(\Phi_i^*) , \quad (6.99)$$

where  $W$  is a function of chiral superfields only, and not their conjugates. Because of this we say that the superpotential is a ‘holomorphic’ function of the chiral superfields. By defining  $W^i = \frac{\partial W}{\partial A_i}|_{\theta=0}$ , and  $W^{ij}$  by analogy, then we find

$$\int d^2\theta W(\Phi_i) = W^i F_i - \frac{1}{2}W^{ij}\psi_i\psi_j - (\text{total derivative}) . \quad (6.100)$$

By inspecting the kinetic terms for the component fields in eq.(6.97) we can see that there are no derivative terms for the field  $F$ , and thus it does not propagate. We can then simplify the supersymmetric Lagrangian by solving the Euler-Lagrange equation for  $F$ , i.e. solving  $\partial\mathcal{L}/\partial F = 0$ . After performing this final step we find that  $F_i = -W^{*i}$ . Using this, rearranging total derivative terms, and employing the equations of motion, our final supersymmetric Lagrangian, in component form, is

$$\mathcal{L} = \partial_\mu A^{*i}\partial^\mu A_i + i\bar{\psi}^i\bar{\sigma}^\mu\partial_\mu\psi_i - \frac{1}{2}\left(W^{ij}\psi_i\psi_j + W_{ij}^*\bar{\psi}^i\bar{\psi}^j\right) - W^{*i}W_i . \quad (6.101)$$

This completes the construction of theories with  $\mathcal{N} = 1$  supersymmetry containing scalars and fermions. It is quite remarkable that one can package fields in such a way that whatever you do, if the theory is written as in eq. (6.98) the theory will inevitably be supersymmetric!

In order to include gauge interactions we must also construct theories with vector fields, which are contained in real vector superfields. These arise by considering a superfield,  $\mathbf{V}$ , which is constrained to satisfy  $\mathbf{V}^* = \mathbf{V}$ . Such a superfield can be constructed from the general superfield in eq.(6.91). The general form for  $\mathbf{V}$  contains numerous component fields, however it is possible to remove some of these fields by performing a suitable gauge transformation. The supersymmetric generalisation of an Abelian gauge transformation acts on  $\mathbf{V}$  as  $\mathbf{V} \rightarrow \mathbf{V} + \mathbf{\Lambda} + \mathbf{\Lambda}^*$ , where  $\mathbf{\Lambda}$  is a chiral superfield. It can be seen by comparing eq.(6.91) and eq.(6.93) that this will correspond to a gauge transformation of  $v_\mu(x) \rightarrow v_\mu(x) + \partial_\mu(A(x) - A^*(x))$ , as expected.

By choosing the ‘Wess-Zumino’ gauge, in which the extra unwanted component fields are gauged away, we have

$$\mathbf{V} = -\theta\sigma^\mu\bar{\theta}v_\mu(x) + i\theta\theta\bar{\theta}\bar{\lambda}(x) - i\bar{\theta}\bar{\theta}\theta\lambda(x) + \frac{1}{2}\theta\theta\bar{\theta}\bar{\theta}D(x) , \quad (6.102)$$

where  $v_\mu(x)$  is a vector field,  $\lambda(x)$  is its fermionic partner, the ‘gaugino’, and  $D(x)$  is a scalar field. We see that  $\mathbf{V}$  is the supersymmetric generalisation of the Yang-Mills potential  $A^\mu$ . The transformation of the component fields under supersymmetry can again be calculated, and it is found that the field  $D(x)$  transforms into a total derivative. We will also need to construct a gauge-invariant field strength. From eq.(6.102) we see that the lowest gauge-invariant components are  $\lambda$  and  $\bar{\lambda}$ . Hence we can construct a gauge invariant chiral superfield  $\mathbf{W}_\alpha = -\frac{1}{4}\overline{D}D D_\alpha \mathbf{V}$ , where chirality follows from  $\overline{D}_\beta \mathbf{W}_\alpha = 0$ .

Now we can construct supersymmetric kinetic terms for the gauge fields as

$$\int d^2\theta \frac{1}{4} \mathbf{W}^\alpha \mathbf{W}_\alpha + \int d^2\bar{\theta} \frac{1}{4} \overline{\mathbf{W}}^{\dot{\alpha}} \overline{\mathbf{W}}_{\dot{\alpha}} = \frac{1}{2} D^2 - \frac{1}{4} F^{\mu\nu} F_{\mu\nu} - i\lambda\sigma^\mu\partial_\mu\bar{\lambda} \quad . \quad (6.103)$$

This completes the construction of an Abelian SUSY gauge sector, however it now remains to include gauge interactions with matter fields.

The lowest component of a chiral superfield is a complex scalar field, which will transform under Abelian gauge transformations by multiplication of a space-time dependent phase. It is clear, then, that in the language of superfields, a gauge transformation of a chiral superfield will proceed as  $\Phi \rightarrow e^{-ig\Lambda}\Phi$ . By considering the gauge transformation of a vector superfield we then see that the combination  $\Phi^* e^{g\mathbf{V}} \Phi$  is gauge invariant, however  $\Phi^* \Phi$  is not. Therefore, to construct a supersymmetric theory with gauge interactions we use the gauge kinetic terms of eq.(6.103), we impose that the superpotential  $W$  is gauge invariant, and we adapt the Kähler potential terms to the form  $\Phi^* \Phi \rightarrow \Phi^* e^{g\mathbf{V}} \Phi$

Finally, from eq.(6.103) we see that we have a new non-propagating auxiliary field,  $D$ . Once again we can solve for  $\partial\mathcal{L}/\partial D = 0$  and find that  $D = g \sum_i q_i A^{*i} A_i$ . After performing this final simplification, rearranging total derivative terms, and extending to the case where the chiral superfields transform under a non-abelian gauge symmetry, we have a supersymmetric gauge theory, with Lagrangian

$$\begin{aligned} \mathcal{L} = & -\frac{1}{4} F^{\alpha\mu\nu} F_{\mu\nu}^a + i\bar{\lambda}^a \sigma^\mu D_\mu \lambda^a + D_\mu A^{*i} D^\mu A_i + i\bar{\psi}^i \bar{\sigma}^\mu D_\mu \psi_i \\ & + i\sqrt{2}g \sum_a (A^{*i} T^a \psi_i \lambda^a - \bar{\lambda}^a T^a A_i \bar{\psi}^i) - \frac{g^2}{2} \sum_a \left( \sum_i A^{*i} T^a A_i \right)^2 \\ & - \frac{1}{2} \left( W^{ij} \psi_i \psi_j + W_{ij}^* \bar{\psi}^i \bar{\psi}^j \right) - W^{*i} W_i \quad , \end{aligned} \quad (6.104)$$

where  $D_\mu$  is the gauge-covariant derivative, and  $T^a$  is a generator of the non-abelian gauge group. This completes the construction of supersymmetric gauge theories.

## R-Symmetry

It is possible, but not required, that a supersymmetric theory can also possess a global  $U(1)$  symmetry under which  $\theta$  transforms. This symmetry is usually referred to as an  $R$ -symmetry, and it is special as it distinguishes between components of a supermultiplet. If this symmetry is present, and  $\theta$  has charge  $q_R$  then the superpotential has charge  $2q_R$  and individual physical components of a chiral or vector superfield differ in charge by a unit of  $q_R$ . Any other global symmetries act on individual components of a chiral multiplet in the same way, and do not act on vector multiplets.

## Quadratic divergences

One of the most attractive features of SUSY is the absence of quadratic divergences. This can be explained quite simply. In a supersymmetric theory in flat space the masses of fields in a SUSY multiplet are equal, by SUSY. Fermion masses do not receive quadratic corrections to their mass thus, by tying the mass of the scalar to the mass of the fermion the scalar itself cannot receive quadratic corrections to its mass.

There is another way of seeing this, where we also learn about something known as the ‘non-renormalization theorem’. As shown before, the superpotential is a holomorphic function of the chiral superfields. In addition, any relevant operators must arise from the superpotential in a renormalizable SUSY theory. We can use the usual spurion trick that has already come up many times and consider any parameters as SUSY-preserving vacuum expectation values (vevs) of some background chiral superfield, and can then write our superpotential with the understanding that all parameters are actually vevs of fields, and assign global symmetry charges to these vevs to find the selection rules. For example, we can consider a toy model with superpotential

$$W = \frac{m}{2}\phi^2 + \frac{\lambda}{3}\phi^3 \quad . \quad (6.105)$$

This theory has a global  $U(1)_R$  symmetry and a global  $U(1)$  symmetry, which are both broken by non-zero values for  $m$  and  $\lambda$ . We can still use the selection rules that arise as a result of these symmetries and write down all renormalizable, holomorphic, terms which behave well in the limits  $m \rightarrow 0$  and  $\lambda \rightarrow 0$ . Doing this we find that the only superpotential terms that are allowed are those already in eq.(6.105). Thus if we consider renormalizing this theory down to some scale then no new terms can arise in the superpotential involving the cut-off. This has been proven at a greater level of rigour for SUSY theories using supergraph techniques [44–47], and using the holomorphicity of the superpotential [48, 49], and is general referred to as the ‘Non-renormalization’ theorem.

The Kähler potential gives the standard kinetic terms, which are still renormalized, giving rise to wavefunction renormalization. Therefore terms in the superpotential are only renormalized through wavefunction renormalization. Wavefunction renormalization is only logarithmic in the cut-off, hence no quadratic divergences occur in this theory. Again, it can be shown, along these lines, that this is true in general for SUSY theories.

## Supersymmetry breaking

As we have not observed any scalar particles with electric charge  $-1$  and a mass of 511 keV we must conclude that the Universe is not supersymmetric, i.e. supersymmetry is broken. However, this does not mean that supersymmetric theories don’t offer a resolution to the hierarchy problem: If supersymmetry is restored at high energies then the hierarchy problem is relieved to the point that the only troublesome hierarchy is between the electroweak scale and the scale at which the theory becomes supersymmetric.

If we want a theory in which a symmetry is present at high energies, but apparently absent at low energies, we require that the symmetry is spontaneously broken somewhere along the way. As supersymmetry is inherently tied to space-time symmetries we must be careful if we want to break supersymmetry spontaneously but not Lorentz symmetry. From

the last of the anti-commutation relations in eq.(6.85) we see that the vacuum energy,  $P_0$ , is given by

$$H = P_0 = \frac{1}{4}(\{Q_1, \bar{Q}_1\} + \{Q_2, \bar{Q}_2\}) \quad . \quad (6.106)$$

As a result, in a globally supersymmetric theory,  $\langle 0|H|0\rangle \neq 0$  implies that  $Q_\alpha|0\rangle \neq 0$  or  $\bar{Q}_\alpha|0\rangle \neq 0$ , and supersymmetry is broken. If we want to find a vacuum in which supersymmetry is spontaneously broken we must then find one with non-vanishing energy density. If we want to maintain Lorentz symmetry then the only fields which obtain vacuum expectation values (VEVs) must be Lorentz scalars, hence the only candidate terms are from the scalar potential. However the scalar potential comes from  $V_{\text{scalar}} = \frac{1}{2}F^{*i}F_i + \frac{g^2}{2}D^a D^a$ . Thus we know that for a supersymmetric theory to spontaneously break supersymmetry requires a cosmologically stable vacuum in which  $F_i \neq 0$  or  $D^a \neq 0$ .

By analogy with spontaneously broken global symmetries, which give rise to a massless Nambu-Goldstone boson, when global SUSY is spontaneously broken this leads to a massless Nambu-Goldstone fermion, named the ‘Goldstino’. Why this is so can be seen quite simply for  $F$ -term breaking of SUSY. At the minimum of the scalar potential we require that  $dV/dA_i = 0$  and this implies that  $W_i^* W^{ij} = 0$ . If there is  $F$ -term SUSY breaking then  $\text{Abs}[W_i^*] \neq 0$ , and hence  $W_{ij}$  has a zero eigenvalue, with eigenvector  $W_i^*$ . But the fermion mass matrix is given by  $W_{ij}$ , and, as a result, there must exist a massless fermion, which lives in the chiral multiplet that breaks SUSY. A similar argument applies for  $D$ -term breaking, however in this case the goldstino is a gaugino of a vector multiplet.

The spontaneous breaking of supersymmetry leads to mass-splittings between component fields of a superfield. It can be shown that in a theory with spontaneous SUSY breaking a mass-sum rule,  $\text{Tr}[M_{\text{scalars}}^2] = \text{Tr}[M_{\text{fermions}}^2]$ , where the scalars are real, is obeyed. This rule implies that if SUSY is broken spontaneously in the visible sector we should have observed scalars with SM charges as light as the lightest fermions. As these scalars have not been observed then SUSY must be broken in another sector, and then this SUSY-breaking must be communicated to the visible sector, raising the masses of the unobserved superpartners.

This pattern of SUSY-breaking can be accounted for if we allow for some ‘spurion’ superfield,  $\mathbf{X}$ , with non-zero  $F$ -term in the vacuum, i.e.  $\langle \mathbf{X} \rangle = \theta^2 F_X$ . Alternatively one can consider a vector superfield with a non-zero  $D$ -term. If some ‘messengers’ which communicate with the SUSY-breaking sector and the visible sector have mass  $M_M \gg M_{\text{weak}}$  we can integrate them out, and include their effects by considering the effective field theory, with higher dimension operators involving the field  $\mathbf{X}$  and the visible sector fields. Operators such as

$$K \supset \frac{\mathbf{X}^\dagger \mathbf{X}}{M_M^2} \Phi_i^* \Phi_i \quad , \quad W \supset \frac{\mathbf{X}}{M_M} \Phi_i \Phi_j \Phi_k \quad , \quad W \supset \frac{\mathbf{X}}{M_M} \mathbf{W}^\alpha \mathbf{W}_\alpha \quad , \quad (6.107)$$

lead to SUSY-breaking mass-terms for the scalars of a chiral superfield,  $\tilde{m} = F_X/M_M$ , trilinear scalar interactions,  $|A_{ijk}| = F_X/M_M$ , or mass terms for the gauginos in a vector superfield,  $M_\lambda = F_X/M_M$ . All such terms break supersymmetry ‘softly’, as they do not introduce new quadratic  $UV$ -divergences into the theory, and only lead to quadratic divergences up to the scale of the soft-terms.

The messenger superfields could be associated with some  $UV$ -completion, and would thus typically have  $M_M \simeq M_P$ , where  $M_P$  is the Planck mass. This scenario is usually referred to as ‘Gravity Mediation’. Alternatively they could potentially have much lower mass, and

communicate with the visible sector through gauge interactions. In this case  $M_M$  is not set, but the soft terms come dressed with a loop-factor involving gauge charges.

## Supergravity

General relativity (GR) is a successful theory of gravity on macroscopic scales, and is hence desirable in any physical theory. We can think of GR as a theory of gauged local Lorentz transformations, however, by going to a SUSY theory we have extended the Lorentz group to include fermionic generators. Thus, if we gauge the Lorentz transformations we must also gauge local SUSY transformations in order to maintain SUSY. In doing so we find a theory of *local* supersymmetry. This theory is called ‘Supergravity’ (SUGRA). It is sometimes touted as a surprising, and/or compelling, feature that gauging SUSY leads to GR, however this should really come as no surprise as we still have the Lorentz group as a subgroup of the general SUSY transformations, and one should then expect that gauging these transformations would lead to GR.

There are many interesting features of SUGRA, which is a subject of much study in its own right, however, for brevity, we will only comment on the features relevant to BSM.<sup>7</sup> Perhaps the most interesting relevant feature of SUGRA is the requirement of a new spin-3/2 field, called the gravitino, which is partnered with the graviton. This field has its own set of Planck-suppressed interactions with other SUSY fields. An interesting analogy with local gauge theories arises when SUSY is spontaneously broken. When a global symmetry is spontaneously broken we expect a massless Nambu-Goldstone boson, and if this symmetry is gauged we expect this boson to be ‘eaten’ by the massless gauge boson, leading to a massive gauge boson. Interestingly, when SUSY is spontaneously broken we have a massless fermion, the goldstino, however in a SUGRA theory this goldstino is ‘eaten’ by the gravitino, leading to a massive gravitino.

## The MSSM

Now we are equipped to construct a supersymmetric theory of the known particles and interactions. We will consider first the minimal model, a.k.a. the ‘Minimal Supersymmetric Standard Model’ (MSSM). In a supersymmetric version of the SM we will have to introduce superpartners for all of the known fields of the standard model. It is conventional notation to denote a superpartner of a SM field with a tilde, i.e. a  $\tilde{e}_L$  is the superpartner of the left-handed electron. The fermions of the standard model are contained in chiral superfields, and thus we introduce ‘squarks’ in addition to the quarks, and ‘sleptons’ in addition to leptons. Scalar partners of SM fermions are individually named with an ‘s’ in front of the name of their fermion partner, i.e. sneutrino, selectron, sbottom, etc. The gauge fields will have to live in a vector superfield and will thus have fermionic superpartners. The partners of the gauge fields are termed ‘gauginos’ and, in specific cases, are differentiated from their bosonic partners by the suffix ‘ino’. Thus along with gluons we now have gluinos, with W-bosons winos, and with the hypercharge boson the bino. After electroweak symmetry breaking we have charginos and two neutralinos from the electroweak gauge sector.

---

<sup>7</sup>An excellent textbook focussing specifically on SUGRA is [50].



Field	Gauge rep.	R-parity	Supermultiplet
$Q$	$(\mathbf{3}, \mathbf{2}, \frac{1}{6})$	$-1$	Chiral
$U^c$	$(\bar{\mathbf{3}}, \mathbf{1}, -\frac{2}{3})$	$-1$	Chiral
$D^c$	$(\bar{\mathbf{3}}, \mathbf{1}, \frac{1}{3})$	$-1$	Chiral
$L$	$(\mathbf{1}, \mathbf{2}, -\frac{1}{2})$	$-1$	Chiral
$E^c$	$(\mathbf{1}, \mathbf{1}, 1)$	$-1$	Chiral
$H_u$	$(\mathbf{1}, \mathbf{2}, \frac{1}{2})$	$1$	Chiral
$H_d$	$(\mathbf{1}, \mathbf{2}, -\frac{1}{2})$	$1$	Chiral
$G$	$(\mathbf{8}, \mathbf{1}, 0)$	$1$	Vector
$W$	$(\mathbf{1}, \mathbf{3}, 0)$	$1$	Vector
$B$	$(\mathbf{1}, \mathbf{1}, 0)$	$1$	Vector

**Table 1:** The superfield content of the MSSM.

The simple extension of the SM to a SUSY theory enters difficulties when we consider the SM Higgs boson. Because the Higgs is a scalar, in a SUSY theory it will have a fermionic partner, the higgsino. This higgsino will have SM gauge charges and is a new fermion contributing to anomalies in the previously anomaly-free SM. Thus in order to cancel this new contribution we must add an additional chiral superfield with the opposite gauge charges of the Higgs. Hence a supersymmetric theory has two Higgs doublets, as opposed to one in the SM, and these doublets are ‘vector-like’, as they have equal and opposite gauge charges. It is often stated that, as the superpotential is holomorphic and terms such as  $H_U^\dagger Q D^c$  are not allowed, then an extra Higgs doublet must be introduced in order to give down-type fermions mass. However this is not strictly true, as we know that SUSY must be broken, and once SUSY is broken such arguments do not apply, whereas a gauge symmetry in QFT must be anomaly-free, regardless of SUSY.

The superfields of the MSSM are summarised in table 1. The kinetic terms and gauge interactions for all fields are as in eq.(6.104), and the superpotential for the MSSM is

$$W_{\text{MSSM}} = \mu \mathbf{H}_u \mathbf{H}_d + \lambda_u \mathbf{H}_u \mathbf{Q} U^c + \lambda_d \mathbf{H}_d \mathbf{Q} D^c + \lambda_e \mathbf{H}_d \mathbf{L} E^c \quad (6.108)$$

where the  $\lambda$  are  $3 \times 3$  Yukawa couplings and summation over flavour indices is implied. Additional gauge-invariant, renormalizable, terms which violate baryon or lepton number are also allowed. These are  $\mathbf{L} \mathbf{L} E^c$ ,  $U^c D^c D^c$ ,  $\mathbf{L} \mathbf{Q} D^c$  and  $\mu_L \mathbf{L} \mathbf{H}_u$ . These terms can lead to rapid proton decay, amongst other forbidden processes, and thus should be suppressed. To do this we impose an additional global symmetry by hand. This symmetry is a discrete  $\mathbb{Z}_2$  symmetry which is a subgroup of R-symmetry, known as R-parity. The R-parity charges of the MSSM superfields are shown in table 1, and the Grassmann parameter  $\theta$  is also odd under this parity, hence the name ‘R’-parity. As  $\theta$  is charged under this parity superpartners within a supermultiplet have different charges. Thus all SM fermions, gauge bosons, and both scalar Higgs doublets are even under this parity, whereas all superpartners such as

gauginos, squarks, sleptons and higgsinos, are odd. Hence R-parity distinguishes between the SM particles and those which we have added, with the exception of the extra Higgs doublet.

### Soft Masses.

The model as described so far is completely supersymmetric, however we have not observed any R-parity odd particles, and thus we must softly break the supersymmetry. We say that the breaking is soft because we only include operators that preserve SUSY in the high energy limit. To achieve this we add only terms that are less and less relevant at high energies. Such operators have mass dimension  $D < 4$ , thus we can add explicit mass terms for fields that break SUSY at the scale  $m$ , safe in the knowledge that they do not spoil the cancellation of quadratic divergences at energies above  $E \gg m$ . In practise these soft terms can be generated by some particular underlying model for SUSY breaking.

This is achieved at a phenomenological level by adding soft masses for all scalar fields and all gauginos. We must also add to the scalar potential trilinear scalar interactions with the same structure as the trilinear terms in the superpotential in eq.(6.108), as well as a ‘ $B_\mu$ ’ term  $\mathcal{L} \supset B_\mu H_u H_d$  which mixes the two Higgs fields. All such soft-parameters are, in general, complex, and need not have the same flavour structure as the SM Yukawa couplings. This completes the construction of the MSSM as a phenomenological model.

### Successes and motivation

The greatest success of the MSSM is that it addresses the hierarchy problem by removing quadratic divergences, thus stabilising the electroweak scale against corrections from unknown physics in the far UV. There are however, additional hints that add to the appeal of the MSSM. We briefly discuss these in no particular order.

### Dark Matter

A particularly attractive feature of the MSSM arises as a result of protecting protons from decaying. In section 6.5 we showed that an extra global symmetry, R-parity, must be imposed in order to conserve baryon number and lepton number at the renormalizable level. This extra symmetry largely distinguishes between SM particles and their partners, and has the consequence that the lightest of the superpartners cannot decay, and is thus cosmologically stable. If this stable particle is charged, or coloured then this stability is disastrous, however if it is neutral then it may be a candidate for DM. It turns out that there are ten neutral particles, four ‘neutralinos’ which are each a mixture of the bino, zino, and two higgsinos, and there are also three neutral sneutrinos. The correct abundance of all of these particles can remain as a result of the thermal freeze-out mechanism, suggesting that they could be the DM. DM direct detection experiments place stringent bounds on how strongly the DM can couple to nucleons, and this rules out the left-handed sneutrinos as DM candidates, however if the lightest neutralino is dominantly made up of higgsino, or bino, components then it can still make a good candidate for DM. Thus, as a result of protecting the proton from decay, the MSSM contains a good candidate for DM. This will be discussed in Laura Covi’s lectures.

## Radiative Electroweak Symmetry Breaking

An additional, unexpected feature of the MSSM is that, for a large range of parameters, the mass of the up-type Higgs boson is driven negative by radiative corrections. The result being that even if the electroweak gauge symmetry is unbroken in the theory at high energies, when one runs all of the parameters down to the weak scale the Higgs mass-squared becomes negative, and the electroweak gauge symmetry is spontaneously broken. This is due to the large Yukawa coupling of the Higgs multiplet to the top multiplet. Electroweak symmetry breaking in this manner is not always guaranteed, however it does seem to be a fairly generic feature of the MSSM, and similar extensions. Additionally, the Higgs seems to be special in this respect as for most parameter regions no other scalars are driven to develop a vev.

## Baryogenesis

Another hint lies in the problem of baryogenesis. It is known that in order to generate an asymmetry between baryons and antibaryons in the early Universe the three conditions of baryon-number violation, CP-violation, and out of thermal equilibrium dynamics must be satisfied. These are known as the ‘Sakharov conditions’, after Andrei Sakharov, who first wrote them down.<sup>8</sup> It was once hoped that such conditions could be present during the electroweak phase transition, as there is CP-violation in the quark sector, baryon-number violation due to electroweak non-perturbative effects (sphalerons) and if the electroweak phase transition is strongly first-order enough then in the bubble walls, which separate the symmetric phase from the broken phase, there should exist out of thermal equilibrium conditions. Unfortunately, in the SM these conditions are not met to the extent that the observed asymmetry can be achieved. However, going beyond the SM it is possible to meet these conditions, with the introduction of new sources for all three necessary conditions. A plethora of models for baryogenesis exist, but even within the MSSM such a scenario is now possible.

## Flavour and Neutrino Puzzles

The MSSM itself does not provide an explanation for the puzzle of the hierarchies of quark and lepton Yukawas, nor for the relatively miniscule neutrino masses, however SUSY permits to have perturbatively stable mass hierarchies between fundamental scalars, thus if any solution to these puzzles requires new physics at high energies, SUSY provides a natural accommodation of a light Higgs mass despite these high energy scales.

## Gauge Coupling Unification

An unexpected surprise that arises whenever the Standard Model is supersymmetrized connects the behaviour of the Standard Model gauge couplings to a deep idea concerning the nature of the forces at extremely high energies. When the superpartners are added, it was found that upon evolving the  $U(1)_Y$ ,  $SU(2)_W$ , and  $SU(3)_C$  gauge couplings up to high energies they appeared to unify at energies close to  $E \sim 10^{16}$  GeV [51, 52]! This is shown in Fig. 8. Of course, that two lines will cross is almost guaranteed, however three lines crossing

---

<sup>8</sup>Google him.

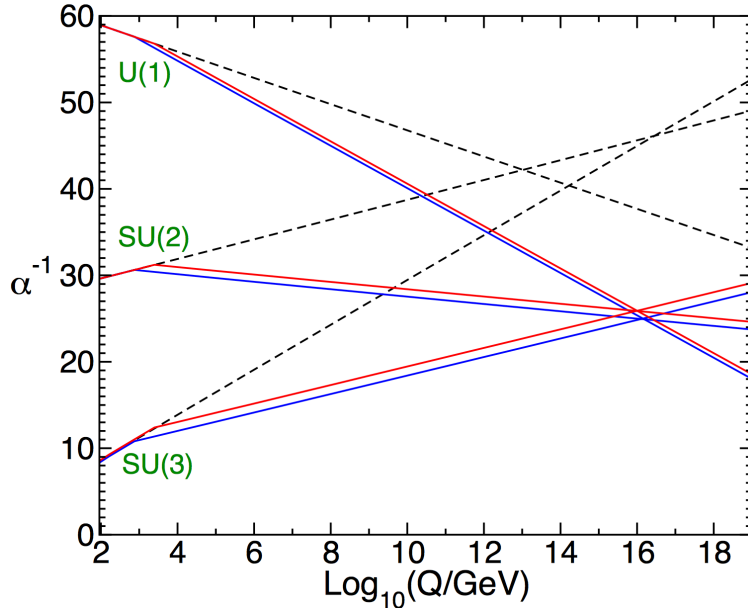

**Figure 8:** Renormalization group evolution of gauge couplings up to high energies, taken from [41]. The Standard Model gauge couplings are shown in dashed black and the gauge couplings with superpartners added, with masses in the range  $0.75 \rightarrow 2.5$  TeV, are shown in red and blue. Unification of the forces at high energies is clearly apparent in the supersymmetric case.

almost at a point is strongly suggestive of a deeper structure and a potential link between SUSY and unification. This is especially compelling as SUSY is precisely the ingredient that would allow for a stable hierarchy between the unification scale and the weak scale!

Ever since the unification of the electroweak forces was discovered, it has been believed that further unification of all gauge forces, now including  $SU(3)_C$ , may occur at very high energies. A variety of larger gauge groups into which they may unify have been proposed, however the simplest is arguably an  $SU(5)$  gauge symmetry [53].<sup>9</sup> It is deeply compelling that the Standard Model matter gauge representations neatly fall into multiplets of a larger symmetry, such as  $SU(5)$ , as this need not have been the case. A key feature which must arise at the unification scale in such a theory is that the gauge couplings must themselves become equal. Thus supersymmetric gauge coupling unification is strongly suggestive that supersymmetry may go hand-in-hand with the unification of the forces and, if discovered, the superpartners would provide a low energy echo of physics at extremely high energies.

When considering the role of the superpartners in supersymmetric unification one finds that some are more relevant than others. The reason is that since the matter fermions of the Standard Model fill out complete unified representations, so must their partners, the squarks and the sleptons. Thus although the masses of squarks and sleptons may change the scale at which unification occurs they do not significantly alter whether or not the couplings will unify, unless they are split by large mass differences themselves. This means that the most

<sup>9</sup>It is also possible that the gauge forces unify with gravity, in the context of String Theory, however we will not discuss this possibility here.

important superpartners for gauge coupling unification are the fermions: the gauginos and the Higgsinos.

Studies of supersymmetric gauge coupling unification generally find that for successful unification it is necessary to have gauginos and higgsinos not too far from the weak scale. If the gaugino and Higgsino mass parameters are taken equal, then unification requires  $\mu, \widetilde{M}_{1/2} \lesssim \mathcal{O}(10 \text{ TeV})$  with some uncertainty due to unknown threshold corrections at the unification scale [54]. The scalar soft masses,  $\widetilde{m}_0$ , may be arbitrarily heavy while preserving successful gauge coupling unification. This realization led to the consideration of so-called ‘Split-Supersymmetry’ theories [55–57], in which the main motivations for the mass spectrum are taken from gauge coupling unification and dark matter, as discussed previously.

The fact that, in addition to the gauge forces, also the matter particles are unified in representations of the unified gauge symmetry group, can imply relations between the Yukawa couplings of quarks and leptons at the unification scale [53, 58–62]. To compare such predictions with the measured values of the fermion masses, one has to take into account the supersymmetric loop threshold corrections at the soft breaking mass scale [63–68], which depend on the masses of the superpartners. Including them in the analysis, and using the measured fermion masses and Higgs mass as constraints, unified theories are even capable of predicting the complete sparticle spectrum [68, 69].

## The Higgs Mass

As is common in physics, when new symmetries are introduced to a theory, the predictive power often increases. Because supersymmetry is softly broken, many new parameters associated with this breaking are introduced and certain aspects of the increased predictivity are lost. However, some predictability beyond the SM remains and the Higgs boson mass is a prime example.

In the Standard Model, when the theory is written in the unbroken electroweak phase there are only two fundamental parameters in the scalar potential, the doublet mass  $m_H$ , and the quartic coupling  $\lambda$ . In the broken electroweak vacuum this translates to two fundamental parameters, the Higgs vacuum expectation value  $v = 246 \text{ GeV}$ , and the Higgs scalar mass  $m_h$ . Once these two parameters are set, all other terms, such as the Higgs self-couplings, are determined. Supersymmetric theories take this one step further as supersymmetry relates the Higgs scalar potential quartic coupling to the electroweak gauge couplings in a fixed manner. The story is complicated a little relative to the Standard Model by the two Higgs doublets required in supersymmetric theories, however since the quartic couplings in the scalar potential are no longer free parameters, once the vacuum expectation value is set  $v = \sqrt{v_u^2 + v_d^2} = 246 \text{ GeV}$ , the Higgs mass is now also predicted by the theory. At tree level, this prediction is

$$m_h = M_Z |\cos 2\beta| . \quad (6.109)$$

Clearly for any value of  $\beta$  this prediction is at odds with the observed value of  $m_h \approx 125 \text{ GeV}$  and thus for consistency additional contributions to the Higgs doublet quartic terms are required. Within the MSSM the only potential source is from radiative corrections at higher orders in perturbation theory. The dominant corrections arise from loops of particles with the greatest coupling to the Higgs, the stop squarks [70, 71]. If the soft mass splitting between the top-quark and stop squarks is large enough then radiative corrections which are

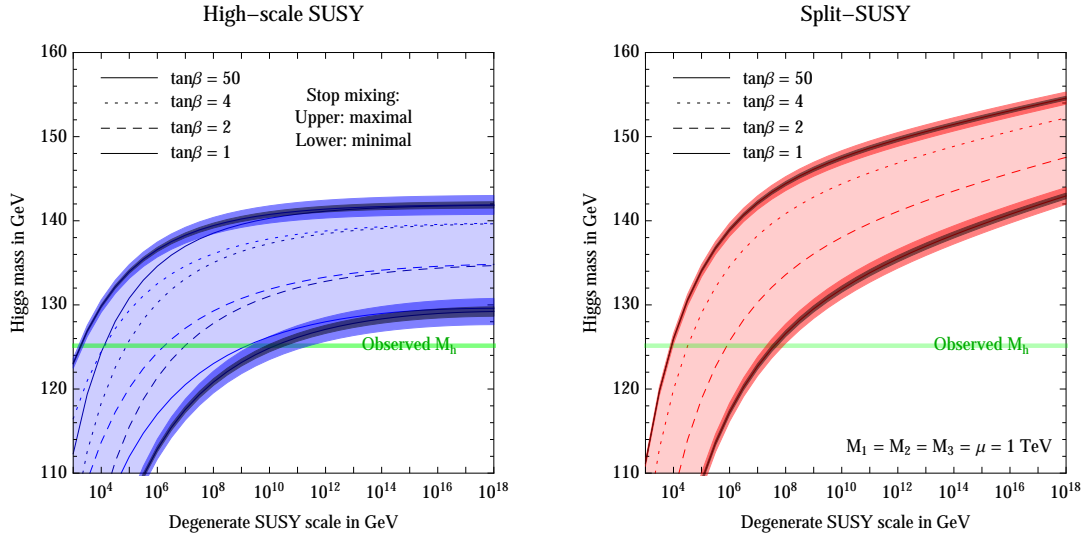

**Figure 9:** Higgs mass predictions as a function of the supersymmetry breaking soft mass scale and the Higgs sector parameter  $\tan\beta$ , taken from [72]. In the High-Scale scenario all soft masses  $\mu, \widetilde{M}_{1/2}, \widetilde{m}_0$  are varied together, whereas in the Split SUSY scenario  $\mu, \widetilde{M}_{1/2}$  are kept at 1 TeV and only the scalar soft masses  $\widetilde{m}_0$  are varied.

sensitive to this supersymmetry breaking may spoil the supersymmetric prediction for the Higgs quartic couplings and allow for contributions that may bring the Higgs boson mass within the observed window.

In Fig. 9 we show the expected soft mass parameter scales which reproduce the observed Higgs mass. Clearly, within the MSSM the observed Higgs mass may be reproduced for scalar masses in the range  $1 \text{ TeV} \lesssim \widetilde{m}_0 \lesssim 10^8 \text{ TeV}$ .<sup>10</sup> Furthermore, if we consider the range  $\tan\beta > 4$ , then scalar masses below  $\mathcal{O}(10\text{'s TeV})$  are required. This is the first upper bound we have encountered for the scalar soft masses, resulting directly from the Higgs mass measurements. Theoretically, this has given rise to a reduction in the allowed parameter space of supersymmetric theories and in the context of so-called Split SUSY, where previously scalar masses could take almost any value, now the Higgs mass measurements have led to the so-called ‘Mini-Split’ scenario [54, 74], where there is an upper bound on the value of the scalar soft masses.

There are variants of the MSSM in which the Higgs mass may also be raised above the MSSM tree-level prediction by utilizing additional effects deriving from couplings to new fields. If the coupling is to new fields in the superpotential then such theories are typically variants of the NMSSM, in which the Higgs doublets couple to an additional gauge singlet. Alternatively, the corrections may arise from coupling to new gauge fields, due to additional contributions to the quartic scalar potential predicted by supersymmetric gauge interactions. Importantly, in these scenarios the additional enhancements of the Higgs mass only serve to reduce the required value of the radiative corrections, and hence the required value of the scalar soft masses. Thus the required scalar soft mass values shown in Fig. 9 serve as an

<sup>10</sup>In fact, if the soft scalar trilinear term  $\widetilde{A}_t$  is chosen so as to maximise the shift in the Higgs mass, the lightest stop squark could be as light as  $\sim 500 \text{ GeV}$  [73].

approximate upper limit for theories beyond the MSSM.

To summarize, the measurement of the Higgs mass has now provided information that is key to understanding the expected mass ranges of superpartners, particularly for the stop squarks. Although scalar masses may be as large as  $\tilde{m}_0 \sim 10^8$  TeV, for a broad range of parameter space, if it is the case that  $\tan \beta > 4$  this upper bound is reduced significantly to  $\tilde{m}_0 \lesssim \mathcal{O}(10\text{'s TeV})$ .

## SUSY circa 2018 and the Hierarchy Problem

With SUSY broken at a scale  $\tilde{m}$ , which represents the soft mass scale, the Higgs mass is no longer protected from quantum corrections. Thus supersymmetry is effective in protecting the Higgs mass all the way down from a high mass scale to the supersymmetry breaking scale  $M_{\text{New}} \rightarrow \tilde{m}$ , however from the soft mass scale down to the weak scale,  $\tilde{m} \rightarrow m_h$  supersymmetry is no longer present. This means that for a natural theory without tuning we must expect  $\tilde{m} \sim m_h$ , and conversely if  $\tilde{m} \gg m_h$  there must be some fine tuning to realize the weak scale below the soft mass scale. These qualitative arguments may be made quantitative. A well motivated measure for the degree of tuning in the weak scale with respect to a given fundamental parameter in the theory,  $a$ , is [75, 76]

$$\Delta[a] = \frac{\partial \log M_Z^2}{\partial \log a^2} . \quad (6.110)$$

By minimising the weak scale potential at large  $\tan \beta$  we find

$$M_Z^2 = -2(m_{H_u}^2 + |\mu|^2) , \quad (6.111)$$

where  $m_{H_u}^2$  is the soft mass for the up-type Higgs which includes all radiative corrections. Let us consider the tree-level contribution from the  $\mu$ -term, along with the one-loop contributions from stop squarks and the winos, and the two-loop contribution from gluinos, which are given by

$$\delta m_{H_u}^2(\tilde{t}) = -\frac{3y_t^2}{4\pi^2} m_{\tilde{t}}^2 \log(\Lambda/m_{\tilde{t}}) \quad (6.112)$$

$$\delta m_{H_u}^2(\tilde{W}) = -\frac{3g^2}{8\pi^2} (m_{\tilde{W}}^2 + m_h^2) \log(\Lambda/m_{\tilde{W}}) \quad (6.113)$$

$$\delta m_{\tilde{t}}^2 = \frac{2g_s^2}{3\pi^2} m_{\tilde{g}}^2 \log(\Lambda/m_{\tilde{g}}) , \quad (6.114)$$

where  $\Lambda$  is a UV-cutoff at which the full UV-completion of supersymmetry kicks in, and the last term may be inserted into the first to obtain an estimate of the tuning from gluinos. Conservatively taking  $\Lambda = 10$  TeV we arrive at the following expectations for a theory which is only tuned at the 10% level [77]:

$$\mu \lesssim 200 \text{ GeV} , \quad m_{\tilde{t}} \lesssim 400 \text{ GeV} , \quad m_{\tilde{W}} \lesssim 1 \text{ TeV} , \quad m_{\tilde{g}} \lesssim 800 \text{ GeV} , \quad (6.115)$$

This picture is clearly at odds with the stop mass values required to achieve the observed Higgs mass in the MSSM, shown in Fig. 9. However it may be that non-minimal structure beyond the MSSM lifts the Higgs mass without requiring large stop masses, thus this

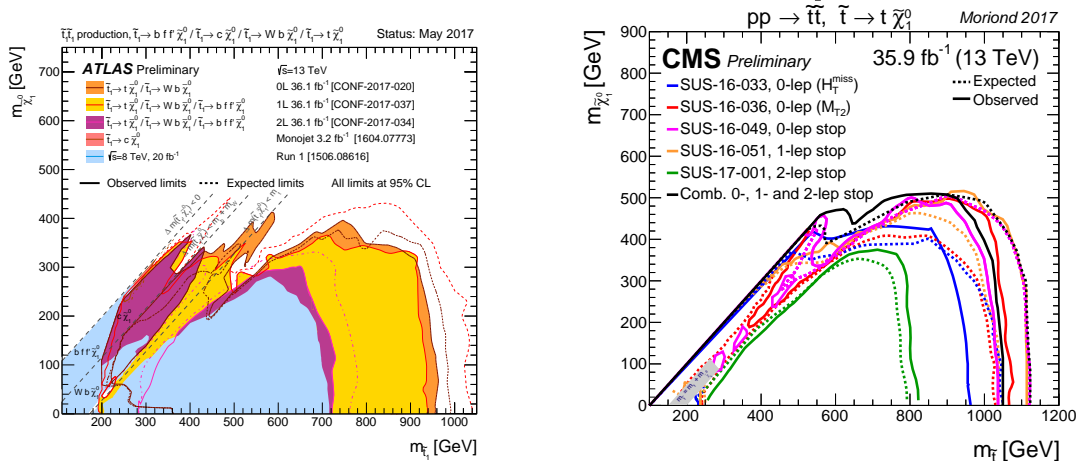

**Figure 10:** Current experimental limits on a simplified model with stop squarks and a neutralino. These limits are already placing significant pressure on SUSY naturalness for this class of models.

constraint is not too significant. More importantly, current constraints on the Higgs boson couplings, which would typically be modified if the stop squarks were light, already place stringent constraints on light stop scenarios.

In many (but not all) concrete scenarios it is expected that the first two generation squarks should not be significantly heavier than the stop squarks and, as the production cross section is enhanced due to valence quarks in the initial state, constraints on first two generation squarks are very strong, indirectly placing strong constraints on the naturalness of many supersymmetric theories. Most relevant, however, are the direct searches for stops and gluinos, which already show that significant portions of this parameter space are in tension with LHC 13 TeV data, as seen in fig. 10 for the stops.

Where do these strong constraints leave the supersymmetric solution to the hierarchy problem? As we are on the brink of a paradigm shift in our understanding of electroweak naturalness a number of possibilities are plausible.

It could be that the weak scale is meso-tuned, as in Mini-Split supersymmetry, and the aesthetic motivations for supersymmetry as a new spacetime symmetry are justified, whereas the naturalness arguments were misguided, to at least some degree, since supersymmetry does solve the big hierarchy problem and we are instead left with a relatively small tuning of the weak scale up to energies as high as  $\mathcal{O}(10^8)$  TeV. This scenario is in some sense quite successful. A fundamental Higgs boson of mass  $m_h \lesssim 135$  GeV is predicted, gauge coupling unification and successful dark matter candidates are realized, all at the cost of accepting some meso-tuning. Although not necessarily guaranteed, the gauginos should be below mass scales of  $\sim \mathcal{O}(\text{few TeV})$ , mostly driven by the dark matter requirement.

Another possibility which has only recently been explored is that the Mini-Split spectrum is realized in nature, with all of the above successes, however the theory is not actually tuned due to a hidden dynamical mechanism which renders the hierarchy from the weak scale to the soft mass scale natural [78]. This can be achieved by employing the cosmological relaxation mechanism of [79] in a supersymmetric context. In this case both the aesthetic arguments



for supersymmetry and the naturalness arguments for the weak scale were well founded, however the two may have manifested in an entirely unexpected manner, with a cocktail of symmetries and dynamics protecting the naturalness of the weak scale up to the highest energies. As before, the gauginos should be below mass scales of  $\sim \mathcal{O}(10\text{'s TeV})$ , however this expectation comes from the fact that a loop factor suppression between scalars and gauginos is expected in this model and in addition the scalars cannot be arbitrarily heavy due to the finite cutoff of the cosmological relaxation mechanism.

Alternatively, a reevaluation of the fine-tuning in the infrared may be required if a spectrum with heavy squarks is made natural due to correlations between soft mass UV-boundary conditions and the infrared value of the Higgs mass, as in ‘Focus Point’ supersymmetry [80] or in the recently proposed ‘Radiatively-Driven’ natural Supersymmetry [81]. In these cases gauginos, Higgsinos, and most likely also stop and sbottom squarks are expected to still be in the sub-10 TeV range. The first two generation squarks may be somewhat heavier.

Finally, it is still possible that the weak scale is relatively natural due to supersymmetry, however the sparticles have evaded detection until now. If this is the case it is likely the stop squarks are still relatively light, in the range of a few 100’s of GeV, and the Higgs mass is raised by an additional tree-level term. For the stop squarks to evade detection there are a number of possible scenarios. We will discuss just a few here. One is an example of a so-called ‘compressed’ spectrum (see e.g. [82]), where the mass splitting between the stop and the stable neutralino is so small that the tell-tale missing energy signature carried away by the neutralino is diminished to the point of being unobservable. Another possibility is ‘Stealth Supersymmetry’ [83, 84], where again the missing energy signatures are diminished, however in this case from sparticle decays passing through a hidden sector. Yet another possibility is for R-parity violating decays of the superpartners [85], since in this case missing-energy signatures are removed and the collider searches must contend with larger backgrounds (see e.g. [86] for models and collider phenomenology). For a natural spectrum the first two generations of squarks must also have evaded detection. One possibility is to raise their mass above experimental bounds, which is compatible with naturalness if they stay within an order of magnitude or so of the gluinos and stops [87–89]. Dirac gauginos also offer opportunities for suppressing collider signatures, at no cost to the naturalness of the theory [90, 91], as Dirac gauginos may naturally be heavier than their Majorana counterparts. This scenario allows not only for the suppression of gluino signatures at the LHC, but also suppresses the t-channel gluino exchange production of the first two generation squarks.

In summary, if we wish for supersymmetry to provide a comprehensive solution to the electroweak hierarchy problem, then the full cohort of sparticles should lie below  $\mathcal{O}(\text{few TeV})$ . Otherwise we are forced into considering at least some fine tuning of the weak scale or alternatively the introduction of an additional mechanism, beyond supersymmetry, to enable a natural weak scale.

## 6.6 Extra Dimensions

In the late 1990’s the theoretical physics community was electrified by an age-old question: “What if there are extra dimensions beyond the four we are familiar with?”. This question came to the fore because it was realised that extra dimensions can solve the hierarchy problem, or at least turn it on its head [92, 93]. Essentially, the hierarchy problem is resolved

if the cutoff of the SM EFT is actually at the weak scale. If this is the case, and the true fundamental theory kicks in around  $\Lambda \sim \text{TeV}$ , then we can understand why the Higgs mass is near to this scale, since this is the natural scale of the theory. This part of the idea was thus not all that radical, however the really radical part was that even the cutoff of the gravity *as we know it* is at the weak scale, rather than at  $M_P \approx 2 \times 10^{18} \text{ GeV}$ . We will see how this works, but first let me point you towards some excellent lectures available online [94, 95].

The N-dimensional graviton is massless, thus it will in general have a momentum described by the null N-vector  $P^M = (p, \underline{p}_3, \underline{p}_E)$  where  $\underline{p}_E$  is the spatial momentum in the extra dimensions. Since the graviton is massless we have  $P_M P^M = 0$ , which we may rearrange as

$$p^2 - |\underline{p}_3|^2 = |\underline{p}_E|^2 \quad . \quad (6.116)$$

Although simple, this equation is very revealing. It tells us that a massless field in N-dimensions will have an apparent 4D mass given by its momentum in the extra dimension!

$$m^2 = |\underline{p}_E|^2 \quad . \quad (6.117)$$

We must still have our familiar massless graviton from 4D, which must then correspond to an N-dimensional graviton with vanishing extra-dimensional momentum  $\underline{p}_E = \underline{0}$ . This also means that the wavefunction of the massless graviton in the extra dimension must be flat in some, since it carries no extra-dimensional momentum  $\partial_m h_0 = 0$ .

A massless graviton in N-dimensions has  $N(N-3)/2$  degrees of freedom. This means that from a 4D perspective we will expect to see not only the massless and massive spin-2 fields in 4D (2 and 5 degrees of freedom respectively), but also additional scalar, vector, and tensor fields all coming from the original N-dimensional metric. For now, we only want to consider the 4D Planck constant, thus we need only consider the massless graviton we see in 4D. Thus, without loss of generality we may write the extra dimensional metric as a background metric accompanied by 4D metric fluctuations. Let us consider extra-dimensional geometries in which, through a coordinate transformation, the metric can be taken to be ‘conformally flat’,

$$ds^2 = \tilde{g}^{MN} dx_M dx_N \quad (6.118)$$

$$= e^{A(x^m)} g^{MN} dx_M dx_N \quad (6.119)$$

$$= e^{A(x^m)} \left( g_4^{\mu\nu}(x_\mu) dx_\mu dx_\nu + \sum_m dx_m^2 \right) \quad (6.120)$$

where Greek indices are for 4D coordinates and lowercase Latin indices are for extra dimensional coordinates. The 4D fluctuations are taken independent of the extra dimensional coordinates, since the massless 4D graviton carries no extra-dimensional momentum.

The Einstein-Hilbert action for gravity in N-dimensions is given by

$$S_{EH} = \int d^N x M_N^{N-2} \sqrt{-\tilde{g}} R(\tilde{g}) \quad (6.121)$$

where  $g$  is the determinant of the metric, and  $R$  is the Ricci scalar. Now, for  $N > 4$  we need to figure out what the effective 4D Planck constant will look like. With a textbook bit

of work, using standard properties of the Ricci scalar under Weyl transformations, and the fact that  $\partial_m g^{\mu\nu}(x_\mu) = 0$ , we may re-write the Einstein-Hilbert action as

$$S_{EH} = \int d^N x M_N^{N-2} e^{\frac{N-2}{2}A(x^m)} \sqrt{-g_4} R_4(g_4) \quad (6.122)$$

where  $R_4(g_4)$  is the usual 4D Ricci scalar. The usual 4D Einstein-Hilbert action is given by

$$S_{EH} = \int d^N x M_P^2 \sqrt{-g_4} R_4(g_4) \quad (6.123)$$

thus we may now identify the observed Planck's constant as

$$M_P^2 = \int d^{N-4} x^m M_N^{N-2} e^{\frac{N-2}{2}A(x^m)} . \quad (6.124)$$

Let us now consider some explicit examples.

### Flat extra dimensions

If the extra dimensions are flat we have  $A(x^m) = 0$ . Then, if the length of each extra dimension is  $r_m$ , we have

$$M_P^2 = M_N^{N-2} \prod_m r_m . \quad (6.125)$$

Let's take each extra dimension to be of the same size  $r_0$ , then, solving for  $M_P \approx 2 \times 10^{18}$  GeV, we have that the required size of the extra dimensions are

$$r_0 \approx 2 \times \frac{10^{\frac{32}{N-4}-19}}{5^{\frac{2}{N-4}}} \left( \frac{1 \text{ TeV}}{M_N} \right)^{\frac{N-2}{N-4}} \text{ m} . \quad (6.126)$$

Clearly, for a single extra dimension we would need the extra dimension to have a size about as large as 5 astronomical units, roughly the distance from the Sun to Jupiter. Since at distances below this scale gravitational physics would start to appear 5D, rather than 4D, the predictions of this theory would not match 4D Einstein's gravity. In fact, gravitational physics on much smaller distance scales has already been probed, so this theory is ruled out.

However, for two extra dimensions, they only need to have a size in the mm level. Gravitational physics on these distance scales is only just beginning to be probed, making this scenario very appealing for laboratory probes of gravity.

Why does such a scenario solve the hierarchy problem? The reason is that the cutoff of the theory is  $M_N \sim \text{TeV}$ 's, and not  $2 \times 10^{18}$  GeV. Essentially, the cutoff of field theory, where the full theory of quantum gravity must kick in, has been moved down to near the weak scale. This means that, from the EFT perspective, there is no hierarchy problem, since the Higgs mass is indeed near the cutoff of the theory, exactly as expected.

There is, however, a delicate subtlety. This comes down to the fact that we now have to understand why the extra dimension is so large [96]. After all, for the  $N = 6$  case the size of the extra dimension corresponds to an energy in the ballpark of 0.1 meV. Now there is a huge hierarchy between fundamental scales  $M_N/(1/r_0)!$  This means that while the electroweak hierarchy problem is resolved, a new one pops up in its place regarding the volume of the extra dimensions. There are, however, ways to get around this problem, as described in [96].

## Randall-Sundrum

Let us make a jump from particle physics to cosmology. In cosmology we have previously faced immense hierarchy problems, related to the flatness and homogeneity of the universe. The flatness problem relates to the fact that the geometry of the Universe is very close to flat. If the Universe expanded in a radiation-dominated manner since the big bang then the contribution of the curvature must have been initially very finely tuned to avoid the curvature dominating at late times. Similarly, the horizon problem is also a fine-tuning problem in the sense that the initial conditions could have been very precisely fine-tuned to make it appear homogeneous now, however that is not what one would generally expect if the big bang only involved a radiation-dominated epoch.<sup>11</sup>

Of course, cosmologists have had tremendous success in solving these hierarchy problems through the theory of inflation, so let us revisit the details. Einstein's equations in the presence of a cosmological constant are, in a general number of dimensions, given by

$$G_{MN} = -\Lambda g_{MN} \quad . \quad (6.127)$$

Let us consider two general metrics of the form

$$ds^2 = -dt^2 + e^{\sqrt{\pm 2\alpha/3}t} \sum_m dx_m^2 \quad , \quad ds^2 = e^{\sqrt{\pm 2\alpha/3}x_M} \left( -dt^2 + \sum_{m \neq M} dx_m^2 \right) + dx_M^2 \quad (6.128)$$

where the indices run over all spatial dimensions. These metrics are clearly of the same form, yet in the first the time direction is 'special', and in the latter a spatial direction is special. Respectively they yield an Einstein tensor of the form

$$G_{MN} = -\alpha g_{MN} \quad , \quad G_{MN} = \alpha g_{MN} \quad . \quad (6.129)$$

Thus, for  $\Lambda > 0$ , corresponding to a positive cosmological constant and de-Sitter geometry, we may choose  $\alpha = \Lambda$  and we recover the usual solution for cosmological inflation. As we move along the time dimension the proper distance between two space-time points grows exponentially. This is highly non-trivial, as it can explain how spacetime events that appear to be causally connected only now, for example photons coming from opposite sides of the Universe, may in fact have been causally connected at earlier times. This explains the horizon problem. The flatness problem is similarly solved. Thus inflation solves these hierarchy, or fine-tuning, problems very convincingly. These hierarchies really do deal with hierarchies of scales, thus it is appealing to consider whether a similar mechanism could be used for the weak scale.

Let us now consider  $\Lambda < 0$ . This is anti-de-Sitter geometry. If there is an additional extra dimension, that we will parameterise with the coordinate  $y$ , then we can use the second metric with a scale factor  $e^{\pm\sqrt{2|\Lambda|/3}y}$ . Everything should follow in analogy with the inflationary case, however the scales will now become exponentially warped as we move along an extra spatial dimension. This is, in fact, the proposal of Randall and Sundrum [97]. Let us now see in detail how this works.

There are different ways in which one can frame this proposal, however the one which illuminates the mechanism most clearly is one in which all fundamental parameters are taken

---

<sup>11</sup>I'll leave it to the cosmology talks to cover these topics in more detail!

to be of order the Planck scale. So let us take  $M_P \sim M_5 \sim \alpha$ . The last parameter we will trade for  $k = \alpha/3$ , which can be easily inserted into the metric above. Now let us imagine the Higgs boson is not a 5D field, but in fact lives on a 4D slice of the extra dimension, that we will locate at  $y = y_0$ . Following the standard EFT rules we will write the Higgs mass at the same mass scale as the other parameters in the theory, thus the quadratic action for the Higgs living on this slice is

$$\mathcal{L} = \int d^4x dy \delta(y - y_0) \frac{\sqrt{-\tilde{g}}}{\sqrt{g_{55}}} (g_{\mu\nu} \partial_\mu H^\dagger \partial_\nu H^\dagger - \lambda(|H|^2 - f^2)^2) \quad , \quad (6.130)$$

where, as indicated above, the decay constant is near the Planck scale  $f \sim M_P$ . Let us now insert the explicit form of the metric and integrate over the delta function

$$\mathcal{L} = \int d^4x e^{-4ky_0} (e^{2ky_0} \eta^{\mu\nu} \partial_\mu H^\dagger \partial_\nu H^\dagger - \lambda(|H|^2 - f^2)^2) \quad . \quad (6.131)$$

Finally, canonically normalising the Higgs field, we have

$$\mathcal{L} = \int d^4x \left( \eta^{\mu\nu} \partial_\mu H^\dagger \partial_\nu H^\dagger - \lambda (|H|^2 - f^2 e^{-2ky_0})^2 \right) \quad . \quad (6.132)$$

Remarkably, the natural scale for the Higgs vacuum expectation value is exponentially dependent on the position of the brane on which the Higgs field lives. This is the essence of the Randall-Sundrum solution to the hierarchy problem, and we can arrive at a natural value for the weak scale with  $y_0 \sim k^{-1} \log v/M_P$ . Since the brane position is only logarithmically dependent on the required separation of scales the hierarchy problem is truly solved in the sense that the radius of the extra dimension need not be hierarchically larger than the relevant length scales.

One might correctly object that we do not, in fact, live in an AdS universe. This issue is, however, relatively straightforward to resolve. To fully solve Einsteins equations one must also consider the boundaries of the extra dimension. It turns out that one can place 4D slices at these boundaries with their own cosmological constant and if one choose a finely-tuned value for the cosmological constant on these branes the final 4D Universe may in fact have a small cosmological constant. This is a tuning, but it is none other than the fine tuning we must accept for the cosmological constant in the first place, thus it is not related to the electroweak hierarchy.

### Other geometries / Linear Dilaton theory

There are many different geometries that may be interesting to study. As an example, consider the following theory

$$\mathcal{S} = \int d^4x dy \sqrt{-g} \frac{M_5^3}{2} e^S (\mathcal{R} + g^{MN} \partial_M S \partial_N S + 4k^2) \quad , \quad (6.133)$$

where  $S$  is a scalar field, usually referred to as the dilaton. One can justify this action with a constant shift symmetry  $S \rightarrow S + \alpha$ , accompanied by a Weyl rescaling  $g_{MN} \rightarrow e^{2\alpha/3} g_{MN}$ , broken only by the parameter  $k$ , which can thus be naturally small. However, one should

not become overly beguiled by such mixed Weyl-Scalar shift symmetries, as one can always perform a Weyl transformation into a frame, known as Einstein frame, where this is simply a shift symmetry acting on the scalar alone. This transformation is

$$g_{MN} \rightarrow e^{-\frac{2S}{3}} g_{MN} \quad (6.134)$$

which turns the total action into

$$\mathcal{S} = \int d^4x dy \sqrt{-g} \frac{M_5^3}{2} \left( \mathcal{R} - \frac{1}{3} g^{MN} \partial_M S \partial_N S + e^{-\frac{2S}{3}} 4k^2 \right) . \quad (6.135)$$

Whether one works in Jordan frame or Einstein frame is irrelevant, the physics will be the same. For fun, let's stay in the Jordan frame. The EOM for  $S$  is

$$\partial_y e^S \partial_y S - 4k^2 e^S = 0 . \quad (6.136)$$

This is solved for the spacetime-dependent background value  $\langle S \rangle = \pm 2ky$ . Interestingly, the background metric in this frame is flat  $g_{MN} = \eta_{MN}$ . Alternatively, one could have worked in the Einstein frame, and deduced the same result.

This setup also allows for a solution of the hierarchy problem, somewhere between the flat and RS cases, with very interesting phenomenology. This scenario demonstrates an even richer realm of possibilities than before, as the behaviour of fields and their couplings is no longer solely determined by the metric, but by the interactions with the dilaton. This can be seen in the Jordan frame, where the metric is entirely flat, whereas some bulk 5D operator, or brane localised operator, may couple differently to the dilaton

$$\mathcal{L} = \sum_j c_j e^{\alpha_j S} \mathcal{O}_j \quad (6.137)$$

where  $\mathcal{O}_j$  could contain SM fields, the coefficient  $c_j$  depends on the microscopic structure of the UV theory, and  $\alpha_j$  depends on the charge of the operator  $\mathcal{O}_j$  under the dilaton shift symmetry. This means that different quantities may be warped by different exponential factors, unlike in RS where one does not have this freedom.

### Mass spectra, wavefunctions, localisation, and all that.

There is a tremendous amount of interesting phenomenology related to extra dimensional models. This involves the spectra of additional resonances, and other notions such as localisation of fields, which is related to the wavefunctions of various modes in the extra dimension. To develop some familiarity with these aspects let us consider a simplified scenario, which is a massless 5D scalar  $\phi$  in a nontrivial background geometry. Without loss of generality we may write the action as

$$\mathcal{S} = -\frac{1}{2} \int d^4x \int_{-\pi R}^{\pi R} dy e^{A(y)} [(\partial_\mu \phi)^2 + (\partial_y \phi)^2] . \quad (6.138)$$

where  $A(y)$  is some general function. Note that both Randall-Sundrum and Linear Dilaton models can be written in this form, and in general any 5D geometry will take this form as one

may always perform a diffeomorphism to go to this ‘conformally flat’ frame. Interestingly, if the prefactor has come only from the metric, and not additional factors such as a background scalar profile, then it turns out that the mass spectrum and wavefunctions are the same for the massless bulk scalar as for the graviton. Let us see what they are.

As the extra dimension is finite, extra dimensional momenta will be quantized, in just the same way as for a particle in a box in quantum mechanics. Thus we may decompose the 5D field as an infinite tower of momentum eigenstates. These eigenstates correspond to 4D mass eigenstates. To do this we perform a Kaluza-Klein reduction into 4D fields

$$\phi(x, y) = \sum_{n=0}^{\infty} \frac{\tilde{\phi}_n(x) \psi_n(y)}{\sqrt{\pi R}} . \quad (6.139)$$

The 5D field satisfies the equation of motion

$$e^{A(y)} \partial_\mu \partial^\mu \phi + \partial_y e^{A(y)} \partial_y \phi = 0 . \quad (6.140)$$

An on-shell 4D scalar satisfies the equation  $\partial_\mu \partial^\mu \tilde{\phi}_n(x) = m_n^2 \tilde{\phi}_n(x)$ , thus we may rewrite this equation of motion, for each mode, as

$$e^{A(y)} m_n^2 \psi_n(y) + \partial_y e^{A(y)} \partial_y \psi_n(y) = 0 . \quad (6.141)$$

We must now consider the boundary conditions. For a bulk scalar they can in general be complicated, however if there is a boundary mass term then they will typically be of the form  $\partial_y \phi = m \phi$ . This comes from continuity of the equation of motion at the boundary, sometimes known as the ‘jump conditions’. If the boundary mass term is vanishing we have  $\partial_y \phi|_{y=0, \pi R} = 0$ , which is known as a Neumann boundary condition. If the boundary mass term is infinite then we must have  $\phi|_{y=0, \pi R} = 0$ , known as Dirichlet. Note that when choosing boundary conditions the appropriate boundary potential must be there, in order to satisfy conditions known as junction conditions that follow from the discontinuity of the wavefunction over a boundary. Anyway, let’s keep life simple and choose to have no boundary potential, corresponding to Neumann boundary conditions. This is the usual case for the graviton as well.

We see that for this general geometry we have a massless mode with a flat profile

$$\psi_0(y) = \text{const} , \quad m_0 = 0 . \quad (6.142)$$

The other potential zero mode does not satisfy the boundary conditions. This means, for example, that in any general 5D geometry the graviton wavefunction is flat. However, as we will see, this does not imply that the graviton is not localised preferentially towards one end of the extra dimension.

To solve for the wavefunctions of the massive modes we must solve the eigenfunction equation

$$m_n^2 \psi_n(y) + A'(y) \psi_n'(y) + \psi_n''(y) = 0 . \quad (6.143)$$

for whichever specific geometry we are interested in.<sup>12</sup>

---

<sup>12</sup>To simplify things, we may perform a field redefinition  $\psi_n(y) = e^{-A(y)/2} \tilde{\psi}_n(y)$ , such that the equation of motion becomes  $(m_n^2 - A'^2(y)/4 - A''(y)/2) \psi_n(y) + \psi_n''(y) = 0$ . This does not, of course, change the solutions, but may be useful in calculations.

For a flat extra dimension this equation is very simple to solve, since  $A'(y) = 0$ . Subject to the boundary conditions, this leads to the solutions

$$\psi_0(y) \propto \text{const} \quad (6.144)$$

$$\psi_n(y) \propto \cos \frac{ny}{R} \quad , \quad n \in \mathbb{N} \quad (6.145)$$

with mass

$$m_0^2 = 0 \quad , \quad m_n^2 = \frac{n^2}{R^2} \quad . \quad (6.146)$$

For the linear dilaton setup this equation is also simple to solve, since  $A'(y) = -2k$ . Subject to the boundary conditions, this leads to the solutions

$$\psi_0(y) \propto \text{const} \quad (6.147)$$

$$\psi_n(y) \propto e^{k|y|} \left( \frac{kR}{n} \sin \frac{n|y|}{R} + \cos \frac{ny}{R} \right) \quad , \quad n \in \mathbb{N} \quad (6.148)$$

with mass

$$m_0^2 = 0 \quad , \quad m_n^2 = k^2 + \frac{n^2}{R^2} \quad . \quad (6.149)$$

For Randall-Sundrum the solution is a little more complicated. In this case we may write  $A(y) = -3 \log |ky|$ .<sup>13</sup> The solution is now

$$\psi_0(y) \propto \text{const} \quad (6.150)$$

$$\psi_n(y) \propto y^2 \left( J_2(m_n y) - \frac{J_1(m_n/k)}{Y_1(m_n/k)} Y_2(m_n y) \right) \dots \quad , \quad n \in \mathbb{N} \quad (6.151)$$

with mass

$$m_0^2 = 0 \quad , \quad \text{Sol}(J_1(m_n \pi R) Y_1(m_n/k) - Y_1(m_n \pi R) J_1(m_n/k)) = 0 \quad . \quad (6.152)$$

Note that expressions that appear to be different exist in the literature, such as in [95], however one should realise that they are all the same, differing only by a wavefunction redefinition, or a change of coordinates.

To understand the localisation of a Kaluza-Klein modes we need to know where they ‘live’ in the extra dimension. To be sure of making physical statements, one must define a measure that is independent of changes of coordinates. In other words, it must be a diffeomorphism-invariant quantity. The obvious candidate is the field density

$$\frac{dP_n(y)}{dy} = e^{A(y)} |\psi_n(y)|^2 \quad (6.153)$$

since this originates from the diffeomorphism invariant term  $\sqrt{-g} d^5 x |\phi|^2$ . Thus we see that for a flat extra dimension the zero mode and excited modes are evenly distributed along the extra dimension. For the linear dilaton case the excited modes are distributed in exactly the

---

<sup>13</sup>Note that in this basis we usually refer to the coordinate  $z$ , since  $y$  is conventionally reserved for the non-conformally flat version of the metric  $ds^2 = e^{2ky} dx^2 + dy^2$ , but for the sake of consistency of notation here we will stick with the current notation.



same way as a flat extra dimension, but the zero mode is exponentially distributed towards one end of the extra dimension. For Randall-Sundrum it is conventional to make a change of coordinates to the metric  $ds^2 = e^{2ky}dx^2 + d\tilde{y}^2$ , for which we would define  $ky = e^{k\tilde{y}}$ , where one sees that the zero mode is exponentially distributed and the excited modes are evenly distributed, but this time with Bessel functions, rather than sinusoids. This is why we refer to gravity being exponentially localised in Randall-Sundrum, since the 4D graviton is the zero mode, who is indeed exponentially localised at one end of the extra dimension.

These are the basic tools for model building in extra dimensions, where it is possible to localise different fields for different purposes. For example, this has been used to realise models for small neutrino masses, flavour hierarchies, and many other possibilities. Let us now end our foray into the fifth dimension by stepping back into 4D, discretely.

### Dimensional Deconstruction.

While it is natural to associate the physics of extra dimensions with gravity, it is possible to do 5D model building without ever stepping foot into a fully-fledged 5D model. This is based on the idea of ‘dimensional deconstruction’ [98], which essentially borrows the theoretical technology of lattice QCD to do model building! Let us start by considering  $N + 1$  scalar fields in 4D, with the usual kinetic terms

$$\mathcal{L} = \int d^4x \sum_j \frac{1}{2} \partial_\mu \phi_j \partial^\mu \phi_j \quad . \quad (6.154)$$

Now we will add ‘nearest-neighbour’ mass terms between the scalars that are of a form more familiar from condensed matter physics than particle physics

$$\mathcal{L} = \int d^4x \sum_j \frac{1}{2} m^2 (\phi_j - \phi_{j-1})^2 \quad . \quad (6.155)$$

These interactions still respect a shift symmetry  $\phi_j \rightarrow \phi_j + \text{const}$ , thus although the mass terms involve every scalar, a massless mode must emerge once we diagonalise the mass terms since there is a degree of freedom protected by this shift symmetry. Since the shift symmetry acts equally on all fields, when we go from the interaction basis  $\phi_j$ , to the mass basis  $\tilde{\phi}_j$ , through an orthogonal rotation, we will find that the massless mode has an equal overlap with each of the interaction basis fields. The massive modes will have a spectrum that approaches  $m_n \sim mn/N$ , and the overlap between mass eigenstates and interaction eigenstates will be found to be sinusoidal. This is of course very familiar from a flat extra dimension.

To see the connection, let’s revisit some basics of lattice field theory. Take a field living in  $4 + 1$  dimensions  $\phi(x, y)$ , where  $y$  is the extra dimension. In a compact extra dimension this gives rise to an infinite number of 4D fields, as we have seen. We can understand this by having a single 4D field living at every slice of the extra dimension. Now we may discretise the extra dimension, turning it into a lattice. Thus the position along the extra dimension becomes a discrete variable  $y_j = ja$ , where  $a$  is the lattice spacing  $a = L/N$ ,  $L$  is the length of the dimension, and  $N$  is the number of lattice sites. Now we have  $N$  4D fields  $\phi(x, y) \rightarrow \phi_j(x,)$  for each lattice site. The final, crucial, ingredient is that we must have

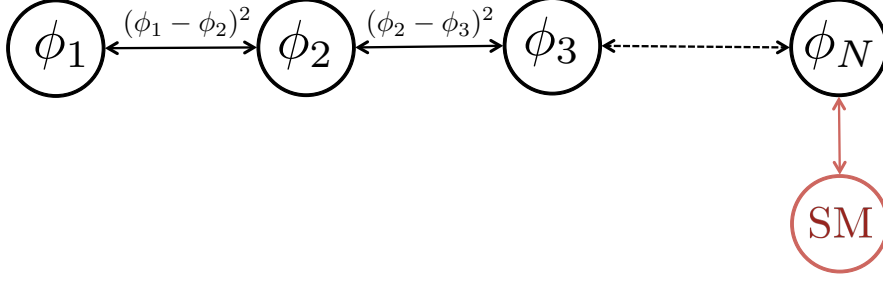

**Figure 11:** A schematic of dimensional deconstruction with a multi-site model. If some SM operator is coupled to the end of the chain it will inherit a suppressed coupling to the massless mode, scaling like  $1/\sqrt{N}$ , as well as a coupling to the massive fields.

some way to deal with extra dimensional derivatives  $\partial_y \phi(x, y) \rightarrow ?$  The correct prescription is of course to simply use the definition of the derivative  $\partial_y \phi(x, y)|_y \rightarrow (\phi_{j+1}(x) - \phi_j(x))/a$ . This is all the machinery we require to transform our extra dimension into a lattice.

Let's put this to practice for a bulk scalar in a flat extra dimension

$$\mathcal{S} = -\frac{1}{2} \int d^4x \int_{-\pi R}^{\pi R} dy [(\partial_\mu \phi)^2 + (\partial_y \phi)^2] \quad (6.156)$$

$$\rightarrow -\frac{1}{2} \int d^4x \left[ \sum_{j=0}^N (\partial_\mu \phi_j)^2 + \sum_{j=0}^{N-1} \frac{1}{a^2} (\phi_{j+1}(x) - \phi_j(x))^2 \right] \quad (6.157)$$

$$(6.158)$$

This is simply the condensed-matter inspired action we wrote above! Thus we see that reversing the direction, the continuum limit  $a \rightarrow 0$ ,  $Na \rightarrow L$ , is simply a massless scalar in a flat extra dimension.

This may seem like a rather trivial set of steps, but it can be tremendously useful in model building. The reason is that one can play with extra dimensional model building, and make use of particle locality in an extra dimension, by playing with models in ‘theory space’, as sketched above. This is shown schematically in fig. 11.

While there is not time to go into it here, this notion of locality is very useful in terms of controlling radiative corrections. For example, when one has a symmetry that is only broken when all interactions between the fields are considered, known as collective symmetry breaking, this means that loop corrections must involve all sites of the chain before they can transmit a symmetry-breaking spurion to some observable. This then means that symmetry-breaking effects can be delayed to very high loop orders, which is particularly useful for composite Higgs models, where we already saw that gauge and Yukawa interactions break the shift symmetry of the Goldstone Higgs. In dimensionally-deconstructed models the relevant dangerous corrections can then be delayed to higher loop order.

## Summary

We have only scratched the surface here, but have already seen that study of extra dimensional scenarios has led to radically new perspectives on the hierarchy problem, as well as a tremendously useful tool in model building: locality. General theoretical tools are rare to

come by, and in some sense locality became a new arrow in the quill of the model builder, alongside symmetries, and is still widely used.

## 6.7 Cosmological Relaxation

The previous approaches to the hierarchy problem have utilised symmetries, internal and spacetime, to explain a small Higgs mass. However, recently a radical new approach to the hierarchy problem, “The Relaxion”, has been proposed [79].<sup>14</sup> This approach uses symmetries in the underlying model, but the Higgs mass itself is not protected by a symmetry. Instead, dynamical evolution of this Higgs mass in the early Universe halts at a point where it is tuned to be much smaller than the cutoff. Essentially one has a dynamical explanation for the tuning!

As described in [79], if the Higgs is a fundamental scalar then the hierarchy problem relates to the fact that if we keep the theory fixed but change the Higgs mass, the point with a small Higgs mass is not a point of enhanced symmetry. However, this may be a special point with regard to dynamics, since this is the point where the SM fields become light.

This perspective suggests that theories may exist where the Higgs mass is an evolving parameter in the early Universe. Once the Higgs mass-squared becomes very small, or passes through zero, some non-trivial dynamics may occur which halts the evolution of the Higgs mass-squared, fixing it at a hierarchically small value. This is precisely the form of the relaxion proposal.

The structure of the theory is relatively simple to write down and we will, as always, rely on EFT arguments. Let us consider the SM as an effective theory at the scale  $M$ , which is the cutoff of the theory. Following the standard EFT rules we include all of the operators, including non-renormalizable ones, consistent with symmetries. All dimensionful scales are taken to the cutoff  $M$ . We add to this theory a scalar  $\phi$  which is invariant under a continuous shift symmetry,  $\phi \rightarrow \phi + \kappa$ , where  $\kappa$  is some constant. This shift symmetry only allows for kinetic terms for  $\phi$ . We then add a dimensionful spurion field  $g$  which breaks this shift symmetry. As  $g$  is the only source of shift symmetry breaking then a selection rule may be imposed, such that any potential terms for  $\phi$  will enter in the combination  $(g\phi/M^2)^n$ . Thus the theory is written

$$\mathcal{L} = \mathcal{L}_{SM} - M^2|H|^2 + g\phi|H|^2 + gM^2\phi + g^2\phi^2 + \dots \quad (6.159)$$

where the ellipsis denote all of the other higher dimension terms and it should be understood that the coefficients of all the operators in eq. (6.159) could vary by  $\mathcal{O}(1)$  factors and the negative signs have been taken for ease of presentation.

The next step is to add an axion-like coupling of  $\phi$  to the QCD gauge fields

$$\frac{\phi}{32\pi^2 f} G\tilde{G} \quad (6.160)$$

As we have learned, this coupling is very special. As  $G\tilde{G}$  is a total derivative, in perturbation theory eq. (6.160) preserves the shift symmetry on  $\phi$ , thus it is consistent to include this

---

<sup>14</sup>A similar idea was considered much earlier for the cosmological constant problem [99], and alternative relaxation-based approaches to the gauge hierarchy problem have also been explored [100,101] more recently.

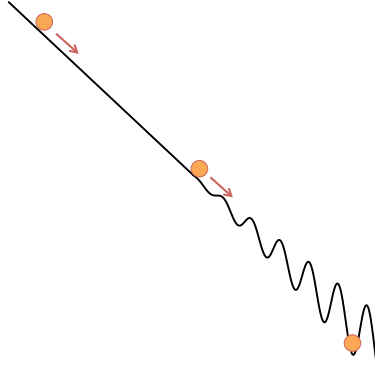

**Figure 12:** Evolution of the relaxion field in the early Universe from a point where the effective Higgs mass-squared is positive (left), passing through zero (middle), and negative (right).

operator without a factor of  $g$  in the coupling. Perturbatively this operator will not generate any potential for  $\phi$ , thus all of the shift-symmetry breaking terms involving  $g$  remain radiatively stable and it is technically natural for them to be small. However, non-perturbatively the full topological structure of the QCD vacuum breaks the shift symmetry  $\phi \rightarrow \phi + \kappa$  down to a discrete shift symmetry  $\phi \rightarrow \phi + 2\pi f z$ , where  $z$  is an integer. Thus the complete story behind the model is one of symmetries.  $\phi$  enjoys a shift symmetry which is broken to a discrete shift symmetry by QCD effects. The discrete shift symmetry is then broken completely by  $g$ .

The final trick lies in the fact that the  $\phi$ -potential generated by QCD effects depends on the light quark masses, which in turn depend on the Higgs vacuum expectation value. In practice this potential is

$$V_{QCD} \sim f_\pi^2 m_\pi^2 \cos \phi / f \quad (6.161)$$

$$\propto f_\pi^3 m_q \cos \phi / f \quad (6.162)$$

$$\propto f_\pi^3 \lambda_{u,d} \langle |H| \rangle \cos \phi / f \quad (6.163)$$

Let us now consider the vacuum structure of the theory for two values of  $\phi$ . If  $M^2 - g\phi > 0$  then the effective Higgs mass-squared is positive. QCD effects will break electroweak symmetry, and quark condensation will lead to a tadpole for the Higgs field, which will in turn lead to a very small vacuum expectation value for the Higgs. Thus in this regime the axion potential of eq. (6.163) exists but is extremely suppressed. If  $M^2 - g\phi < 0$  the effective Higgs mass-squared will be negative and the Higgs will obtain a vacuum expectation value.

## Cosmological Evolution

The general idea of the relaxion mechanism is sketched in fig. 12. Imagine at the beginning of a period of inflation the relaxion field begins at values far from the minimum of the scalar potential. We can, without loss of generality, take this to be at  $\phi = 0$ . Due to its potential it will roll, with Hubble friction providing the necessary dissipation for this to occur in a controlled manner. This Hubble friction can be understood from the equation of motion for

a scalar in an inflating background

$$\partial_t^2 \phi + 3H \partial_t \phi \approx gM^2 + \dots \quad , \quad (6.164)$$

where the ellipsis denotes higher order terms in  $g$ . During inflation  $H = \text{const}$ , and this term provides a constant source of friction, and for large  $H$ , one has a non-accelerating solution to the equations of motion  $\phi \sim (gM^2/3H)t$ . All the while the effective Higgs mass-squared is evolving.

Once the effective mass-squared passes through zero the Higgs will obtain a vacuum expectation value and the axion potential of eq. (6.163) will turn on, growing linearly with the Higgs vev. If the gradient of this potential becomes locally great enough to overcome the gradient of the  $g$ -induced relaxion potential, i.e.

$$\frac{f_\pi^3}{f} \lambda_{u,d} \langle |H| \rangle > gM^2 \quad , \quad (6.165)$$

then the relaxion will stop rolling and become stuck. Once it has become stuck the effective Higgs mass-squared has also stopped evolving. If  $g$  is taken to be appropriately small, then this evolution will cease at a point where the Higgs vev is small  $\langle |H| \rangle \ll M$ . As  $g$  is a parameter which can take values that are naturally small, and  $g$  ends up determining the final Higgs vev, a naturally small value for the weak scale may be generated.

If it could be taken at face value, the picture painted above is quite a beautiful portrait involving SM and BSM symmetries and dynamics. QCD plays a crucial role in determining the weak scale and solving the hierarchy problem. Only an axion-like field, already motivated by the strong-CP problem, is added. Inflation, which is already required in cosmology, provides the dissipation required for solving the hierarchy problem. We even find an explanation for some other puzzles in the SM, such as why there are some quark masses determined by the weak scale which are nonetheless lighter than the QCD strong coupling scale. However, as we will see, some puzzles remain to be understood, presenting a number of interesting areas to explore on the theoretical front.

## Parameter Constraints

To determine the viability of the relaxion mechanism it is necessary to consider any constraints on the theory. We will list them here, and derive them in the lecture.

- $\Delta\phi > M^2/g$ : For the relaxion to scan the entire  $M^2$  of Higgs mass-squared it must traverse this distance in field space.
- $H_I > M^2/M_P$ : Inserting the previous  $\Delta\phi$  into the potential we find that the vacuum energy must change by an amount  $\Delta V \sim M^4$ . For the inflaton to dominate the vacuum energy during inflation we require  $V_I > M^4$ , which corresponds to the aforementioned constraint on the Hubble parameter during inflation.
- $H_I < \Lambda_{QCD}$ : For the non-perturbative QCD potential to form, the largest instantons, of size  $l \sim 1/\Lambda_{QCD}$ , must fit within the horizon.

- $H_I < (gM^2)^{1/3}$ : Fluctuations in the relaxion field during inflation (due to finite Hubble) must not dominate over the classical evolution if the theory is to predict a small weak scale.
- $N_e \gtrsim H_I^2/g^2$ : Inflation must last long enough for the relaxion to roll over the required field range.
- $gM^2f \sim \Lambda_{QCD}^4$ : It must be possible for a local minimum to form in the full relaxion potential whenever the Higgs vev is at the observed electroweak scale.

Combining these constraints it was found in [79] that the maximum allowed cutoff scale in the theory is

$$M < \left( \frac{\Lambda^4 M_{Pl}^3}{f} \right)^{1/6} \sim 10^7 \text{ GeV} \times \left( \frac{10^9 \text{ GeV}}{f} \right)^{1/6} . \quad (6.166)$$

It is compelling that such a large hierarchy can be realised within the relaxion framework. Let us now saturate eq. (6.166) and take  $f = 10^9 \text{ GeV}$  to explore the other parameters of the theory. In this limit we find

$$g \sim 10^{-26} \text{ GeV} \quad , \quad \Delta\phi \sim 10^{40} \text{ GeV} \quad , \quad 5 \times 10^{-5} \text{ GeV} \lesssim H_I \lesssim 0.2 \text{ GeV} \quad , \quad N_e \gtrsim 10^{43} . \quad (6.167)$$

All of these features are quite puzzling or unfamiliar. As such they may represent interesting opportunities for continued theoretical investigation. The parameter  $g$  which explicitly breaks the shift symmetry is extremely small. Recent work along has already shed some light on this question [102]. On a related note, the required field displacement is not only large, it is ‘super-duper Planckian’ [103] How such large field displacements can be accommodated by a story involving quantum gravity remains to be fully understood.

With regard to the inflationary aspects, the Hubble parameter is much smaller than is typical in inflationary models. The number of e-foldings is huge (remember the scale factor grows during inflation by a factor  $\sim e^{N_e}$ ). Although not a problem in principle, it may be difficult to realise a natural inflationary model with the appropriate slow-roll parameters which reheats the Universe successfully and also accommodates the observed cosmological parameters.

A more tangible puzzle arises in the simplest QCD model presented above, as it is already excluded by experiment. In the electroweak breaking vacuum the full relaxion potential will be minimized whenever

$$\frac{\partial V_g}{\partial \phi} + \frac{\partial V_{QCD}}{\partial \phi} = 0 \quad , \quad (6.168)$$

where  $V_g$  is the scalar potential generated from the terms which explicitly break the shift symmetry, all originating from the parameter  $g$ , and  $V_{QCD}$  is the axion-like potential coming from the non-perturbative QCD effects. Since the relaxion is stopped by QCD effects before it reaches the minimum of  $V_g$ , the first term in eq. (6.168) is non zero. This then implies that the second term in eq. (6.168) must also be non-zero. By construction,  $V_{QCD}$  is minimised whenever the effective strong-CP angle is zero, thus if it is not minimised the effective strong-CP angle must be non-zero. In fact, it is typically expected to be close to maximal if the relaxion has stopped in one of the first minima that appears after the Higgs vev starts to grow. This is in clear contradiction with experimental bounds on the strong-CP angle and so the model must be extended, and a number of options have been proposed.

## Summary

The relaxion is not a complete story yet, so it is perhaps premature to include it in a lecture course. However, it is the first step towards a radically different perspective on the hierarchy problem, a perspective that may an important role in BSM theory for a long time to come. We are really just at the starting point in trying to understand cosmological or dynamical approaches to the hierarchy problem, but already there is promise. There have been other proposals since the original relaxion idea. Many of them are based on the relaxion framework, however the recently proposed NNaturalness takes an entirely different, but still cosmological perspective [104]. All I would say at this point is: Watch this space!

## 7 Where do we stand now?

In these lectures I have opted to cover a lot of ground, in not too much detail. The reason for this approach is that the current LHC results have left the field of BSM theory in disarray. This is a very good thing, as there is no single fad that theorists are focussing on, and ever more daring ideas are being put forth as time goes on. Thus to dive into BSM theory nowadays requires a solid grounding in QFT, including the basic principles of EFT, fluency in the basics of cosmology and GR, and most importantly a great deal of imagination guided by the neat ideas of the past. Some of the ideas I have introduced you to, such as the Twin Higgs and the Relaxion, are not textbook material, but this is what makes them exciting. Perhaps some element of these concepts may turn out to be just the ingredient we have been looking for.

One should never overlook the fundamental difference between a theoretical problem and any null experimental results for a *particular solution* to that problem. The only way the theoretical problems I have discussed will go away is if we gain a theoretical or experimental understanding of their solution. The fact that the LHC, or other experiments, have not yet given us clues does not mean the problems have gone away. It means that either the solution is hiding well, or we don't even understand the questions we are asking! This means the stakes are now very high indeed, and we need radical ideas, ones that will push our intuition and our preconceived notions of the fundamental laws of nature to their limits. This is why it's a great time to be a BSM theorist. The problems are starkly laid out, nothing less than a complete paradigm shift appears to be called for, and we have the LHC and a burgeoning field of smaller experiments probing every corner of coupling and mass-scale that we can hope to access. I hope these lecture notes provide a broad enough base from which an ambitious theorist feels ready to jump in.

## 8 Homework

### 8.1 Monday

#### Masses versus scales

- Derive the dimensions in Eq. 2.4 and 2.5 of fields and couplings. Confirm that loop corrections do not carry dimension, and show that the Planck scale is not a mass scale.

## Cosets and Composite Higgs

- Calculate the correction to the SM W-to-Z boson mass ratio coming from eq. (6.59).
- Show that eq. (6.59) cannot be forbidden whenever the Higgs doublet is embedded in an  $SU(3) \rightarrow SU(2)$ -based model as  $\Sigma \approx (h_1 + ih_2, h_3 + ih_4, 0)$ . Now show that it can be forbidden by an  $SO(4)$  global symmetry when the Higgs is embedded in an  $SO(5) \rightarrow SO(4)$  model as  $\Sigma \approx (h_1, h_2, h_3, h_4, 0)$ .
- Start with eq. (6.69) and make a field rotation to go to the fermion mass eigenstate basis. After this, using the standard scaling of a loop integral with the cutoff  $\int d^4q \text{Tr}(mI_4)/(q^2 - m^2) \propto \Lambda^2$  and a similar scaling for  $\int d^4q \text{Tr} q \not{q} / (q^2 - m^2)^2$  show that in loops of fermions the quadratic divergences cancel. Standard identities for loop integrals, such as in the Appendices of Peskin and Schroeder, may be useful.
- Assuming  $H_A$  is the Standard Model Higgs doublet and  $H_B = f + h_T/\sqrt{2}$  (the other three Goldstones have been eaten), determine the scalar  $H_A$  cubic interaction with  $h_T$  and then integrate out  $h_T$  at the diagrammatic level to show that the Twin top quarks cancel the quadratic divergences, confirming the expectation based on the global symmetry breaking pattern.

## 8.2 Tuesday

### Strong CP Problem

- Prove the invariance of eq. (4.16) under chiral rotations, using the standard relations for Dirac matrices.
- Following [17] evaluate the axion mass with non-equal quark masses and axion-pion mixing included. To save time, expand the scalar potential to quadratic order, and then integrate out the  $\pi^0$  by solving  $\partial V/\partial \pi^0 = 0$  and inserting the solution into the potential for the axion.
- Draw the relevant Feynman diagrams for axion production in stars.

## 8.3 Wednesday

### SUSY and Extra Dimensions

- Show that for Grassmann variables  $\theta_1^2 = 0$ . Recalling that  $\theta$  and  $\bar{\theta}$  are left and right-handed Weyl spinors derive the general form of an  $\mathcal{N} = 1$  superfield in eq. (6.91) by Taylor expansion by writing all possible *non-vanishing* Lorentz-invariant terms. For a discussion of Lorentz-invariant Weyl spinor contractions see, for example, Section 2 of [41].
- For a general metric of the form

$$ds^2 = g_{MN} dx^M dx^N = \hat{g}_{\mu\nu}(x, z) dx^\mu dx^\nu + dz^2 \quad . \quad (8.169)$$



Then, up to total derivatives,

$$\begin{aligned} \sqrt{-g}\mathcal{R}_5(g) = & \quad (8.170) \\ \sqrt{-\hat{g}} \left[ \mathcal{R}_4(\hat{g}) + \frac{(\hat{g}^{\mu\nu}\partial_z\hat{g}_{\mu\nu})^2}{4} + \frac{(\partial_y\hat{g}^{\mu\nu})(\partial_y\hat{g}_{\mu\nu})}{4} \right]. \end{aligned}$$

Also, in an 5D a Weyl rescaling changes the Ricci scalar by

$$\mathcal{R}_5(e^{2\omega(y)}g) = e^{-2\omega(y)} (\mathcal{R}_5(g) - 8\partial_y^2\omega - 12(\partial_y\omega)^2) . \quad (8.171)$$

Using these formulae derive eq. (6.122) for the part of the metric containing the massless graviton from eq. (6.121).

## References

- [1] B. Grzadkowski, M. Iskrzynski, M. Misiak, and J. Rosiek, *Dimension-Six Terms in the Standard Model Lagrangian*, *JHEP* **10** (2010) 085, [[arXiv:1008.4884](#)].
- [2] H. Georgi, *Generalized dimensional analysis*, *Phys. Lett.* **B298** (1993) 187–189, [[hep-ph/9207278](#)].
- [3] G. 't Hooft, *Naturalness, chiral symmetry, and spontaneous chiral symmetry breaking*, *NATO Sci. Ser. B* **59** (1980) 135–157.
- [4] P. A. M. Dirac, *New basis for cosmology*, *Proc. Roy. Soc. Lond.* **A165** (1938) 199–208.
- [5] M. E. Peskin and D. V. Schroeder, *An Introduction to quantum field theory*. Addison-Wesley, Reading, USA, 1995.
- [6] M. D. Schwartz, *Quantum Field Theory and the Standard Model*. Cambridge University Press, 2014.
- [7] K. Fujikawa, *Path Integral Measure for Gauge Invariant Fermion Theories*, *Phys. Rev. Lett.* **42** (1979) 1195–1198.
- [8] K. Fujikawa, *Path Integral for Gauge Theories with Fermions*, *Phys. Rev.* **D21** (1980) 2848. [Erratum: *Phys. Rev.*D22,1499(1980)].
- [9] R. J. Crewther, P. Di Vecchia, G. Veneziano, and E. Witten, *Chiral Estimate of the Electric Dipole Moment of the Neutron in Quantum Chromodynamics*, *Phys. Lett.* **88B** (1979) 123. [Erratum: *Phys. Lett.*91B,487(1980)].
- [10] J. E. Kim and G. Carosi, *Axions and the Strong CP Problem*, *Rev. Mod. Phys.* **82** (2010) 557–602, [[arXiv:0807.3125](#)].
- [11] A. E. Nelson, *Naturally Weak CP Violation*, *Phys. Lett.* **136B** (1984) 387–391.
- [12] S. M. Barr, *Solving the Strong CP Problem Without the Peccei-Quinn Symmetry*, *Phys. Rev. Lett.* **53** (1984) 329.

- [13] S. M. Barr, *A Natural Class of Nonpeccei-quinn Models*, *Phys. Rev.* **D30** (1984) 1805.
- [14] M. Dine and P. Draper, *Challenges for the Nelson-Barr Mechanism*, *JHEP* **08** (2015) 132, [[arXiv:1506.05433](#)].
- [15] Y. Nambu, *Quasiparticles and Gauge Invariance in the Theory of Superconductivity*, *Phys. Rev.* **117** (1960) 648–663.
- [16] J. Goldstone, *Field Theories with Superconductor Solutions*, *Nuovo Cim.* **19** (1961) 154–164.
- [17] G. Grilli di Cortona, E. Hardy, J. Pardo Vega, and G. Villadoro, *The QCD axion, precisely*, *JHEP* **01** (2016) 034, [[arXiv:1511.02867](#)].
- [18] J. E. Kim, *Weak Interaction Singlet and Strong CP Invariance*, *Phys. Rev. Lett.* **43** (1979) 103.
- [19] M. A. Shifman, A. I. Vainshtein, and V. I. Zakharov, *Can Confinement Ensure Natural CP Invariance of Strong Interactions?*, *Nucl. Phys.* **B166** (1980) 493–506.
- [20] M. Dine, W. Fischler, and M. Srednicki, *A Simple Solution to the Strong CP Problem with a Harmless Axion*, *Phys. Lett.* **104B** (1981) 199–202.
- [21] A. R. Zhitnitsky, *On Possible Suppression of the Axion Hadron Interactions. (In Russian)*, *Sov. J. Nucl. Phys.* **31** (1980) 260. [*Yad. Fiz.*31,497(1980)].
- [22] **Particle Data Group** Collaboration, C. Patrignani *et. al.*, *Review of Particle Physics*, *Chin. Phys.* **C40** (2016), no. 10 100001.
- [23] M. Lisanti, *Lectures on Dark Matter Physics*, in *Proceedings, Theoretical Advanced Study Institute in Elementary Particle Physics: New Frontiers in Fields and Strings (TASI 2015): Boulder, CO, USA, June 1-26, 2015*, pp. 399–446, 2017. [arXiv:1603.03797](#).
- [24] T. Das, G. S. Guralnik, V. S. Mathur, F. E. Low, and J. E. Young, *Electromagnetic mass difference of pions*, *Phys. Rev. Lett.* **18** (1967) 759–761.
- [25] A. Salvio and A. Strumia, *Agravity*, *JHEP* **06** (2014) 080, [[arXiv:1403.4226](#)].
- [26] K. G. Wilson and J. B. Kogut, *The Renormalization group and the epsilon expansion*, *Phys. Rept.* **12** (1974) 75–200.
- [27] R. Jackiw, *Ken Wilson – The Early Years*, *Int. J. Mod. Phys.* **A29** (2014) 1430008, [[arXiv:1312.6634](#)].
- [28] A. Adams, N. Arkani-Hamed, S. Dubovsky, A. Nicolis, and R. Rattazzi, *Causality, analyticity and an IR obstruction to UV completion*, *JHEP* **10** (2006) 014, [[hep-th/0602178](#)].

- [29] R. Contino, *The Higgs as a Composite Nambu-Goldstone Boson*, in *Physics of the large and the small, TASI 09, proceedings of the Theoretical Advanced Study Institute in Elementary Particle Physics, Boulder, Colorado, USA, 1-26 June 2009*, pp. 235–306, 2011. [arXiv:1005.4269](#).
- [30] M. Schmaltz and D. Tucker-Smith, *Little Higgs review*, *Ann. Rev. Nucl. Part. Sci.* **55** (2005) 229–270, [[hep-ph/0502182](#)].
- [31] S. R. Coleman, J. Wess, and B. Zumino, *Structure of phenomenological Lagrangians. 1.*, *Phys. Rev.* **177** (1969) 2239–2247.
- [32] C. G. Callan, Jr., S. R. Coleman, J. Wess, and B. Zumino, *Structure of phenomenological Lagrangians. 2.*, *Phys. Rev.* **177** (1969) 2247–2250.
- [33] A. De Simone, O. Matsedonskyi, R. Rattazzi, and A. Wulzer, *A First Top Partner Hunter’s Guide*, *JHEP* **04** (2013) 004, [[arXiv:1211.5663](#)].
- [34] Z. Chacko, H.-S. Goh, and R. Harnik, *The Twin Higgs: Natural electroweak breaking from mirror symmetry*, *Phys. Rev. Lett.* **96** (2006) 231802, [[hep-ph/0506256](#)].
- [35] D. Curtin and C. B. Verhaaren, *Discovering Uncolored Naturalness in Exotic Higgs Decays*, *JHEP* **12** (2015) 072, [[arXiv:1506.06141](#)].
- [36] G. Burdman, Z. Chacko, R. Harnik, L. de Lima, and C. B. Verhaaren, *Colorless Top Partners, a 125 GeV Higgs, and the Limits on Naturalness*, *Phys. Rev.* **D91** (2015), no. 5 055007, [[arXiv:1411.3310](#)].
- [37] M. J. Strassler and K. M. Zurek, *Echoes of a hidden valley at hadron colliders*, *Phys. Lett.* **B651** (2007) 374–379, [[hep-ph/0604261](#)].
- [38] M. J. Strassler and K. M. Zurek, *Discovering the Higgs through highly-displaced vertices*, *Phys. Lett.* **B661** (2008) 263–267, [[hep-ph/0605193](#)].
- [39] T. Han, Z. Si, K. M. Zurek, and M. J. Strassler, *Phenomenology of hidden valleys at hadron colliders*, *JHEP* **07** (2008) 008, [[arXiv:0712.2041](#)].
- [40] N. Craig, A. Katz, M. Strassler, and R. Sundrum, *Naturalness in the Dark at the LHC*, *JHEP* **07** (2015) 105, [[arXiv:1501.05310](#)].
- [41] S. P. Martin, *A Supersymmetry primer*, [hep-ph/9709356](#). [Adv. Ser. Direct. High Energy Phys.18,1(1998)].
- [42] H. Baer and X. Tata, *Weak scale supersymmetry: From superfields to scattering events*. Cambridge University Press, 2006.
- [43] S. Weinberg, *The quantum theory of fields. Vol. 3: Supersymmetry*. Cambridge University Press, 2013.
- [44] D. Amati, K. Konishi, Y. Meurice, G. C. Rossi, and G. Veneziano, *Nonperturbative Aspects in Supersymmetric Gauge Theories*, *Phys. Rept.* **162** (1988) 169–248.

- [45] M. A. Shifman and A. I. Vainshtein, *Solution of the Anomaly Puzzle in SUSY Gauge Theories and the Wilson Operator Expansion*, *Nucl. Phys.* **B277** (1986) 456. [Zh. Eksp. Teor. Fiz.91,723(1986)].
- [46] M. A. Shifman and A. I. Vainshtein, *On holomorphic dependence and infrared effects in supersymmetric gauge theories*, *Nucl. Phys.* **B359** (1991) 571–580.
- [47] M. T. Grisaru, W. Siegel, and M. Rocek, *Improved Methods for Supergraphs*, *Nucl. Phys.* **B159** (1979) 429.
- [48] N. Seiberg, *Naturalness versus supersymmetric nonrenormalization theorems*, *Phys. Lett.* **B318** (1993) 469–475, [[hep-ph/9309335](#)].
- [49] N. Seiberg, *The Power of holomorphy: Exact results in 4-D SUSY field theories*, in *PASCOS '94: Proceedings, 4th International Symposium on Particles, Strings and Cosmology, Syracuse, New York, USA, May 19-24, 1994*, pp. 0357–369, 1994. [hep-th/9408013](#).
- [50] D. Z. Freedman and A. Van Proeyen, *Supergravity*. Cambridge Univ. Press, Cambridge, UK, 2012.
- [51] S. Dimopoulos, S. Raby, and F. Wilczek, *Supersymmetry and the Scale of Unification*, *Phys. Rev.* **D24** (1981) 1681–1683.
- [52] S. Dimopoulos and H. Georgi, *Softly Broken Supersymmetry and SU(5)*, *Nucl. Phys.* **B193** (1981) 150–162.
- [53] H. Georgi and S. L. Glashow, *Unity of All Elementary Particle Forces*, *Phys. Rev. Lett.* **32** (1974) 438–441.
- [54] A. Arvanitaki, N. Craig, S. Dimopoulos, and G. Villadoro, *Mini-Split*, *JHEP* **02** (2013) 126, [[arXiv:1210.0555](#)].
- [55] J. D. Wells, *PeV-scale supersymmetry*, *Phys. Rev.* **D71** (2005) 015013, [[hep-ph/0411041](#)].
- [56] N. Arkani-Hamed and S. Dimopoulos, *Supersymmetric unification without low energy supersymmetry and signatures for fine-tuning at the LHC*, *JHEP* **06** (2005) 073, [[hep-th/0405159](#)].
- [57] G. F. Giudice and A. Romanino, *Split supersymmetry*, *Nucl. Phys.* **B699** (2004) 65–89, [[hep-ph/0406088](#)]. [Erratum: *Nucl. Phys.*B706,487(2005)].
- [58] M. S. Chanowitz, J. R. Ellis, and M. K. Gaillard, *The Price of Natural Flavor Conservation in Neutral Weak Interactions*, *Nucl. Phys.* **B128** (1977) 506–536.
- [59] D. V. Nanopoulos and D. A. Ross, *Limits on the Number of Flavors in Grand Unified Theories from Higher Order Corrections to Fermion Masses*, *Nucl. Phys.* **B157** (1979) 273–284.

- [60] H. Georgi and C. Jarlskog, *A New Lepton - Quark Mass Relation in a Unified Theory*, *Phys. Lett.* **86B** (1979) 297–300.
- [61] S. Antusch and M. Spinrath, *New GUT predictions for quark and lepton mass ratios confronted with phenomenology*, *Phys. Rev.* **D79** (2009) 095004, [[arXiv:0902.4644](#)].
- [62] S. Antusch, S. F. King, and M. Spinrath, *GUT predictions for quark-lepton Yukawa coupling ratios with messenger masses from non-singlets*, *Phys. Rev.* **D89** (2014), no. 5 055027, [[arXiv:1311.0877](#)].
- [63] R. Hempfling, *Yukawa coupling unification with supersymmetric threshold corrections*, *Phys. Rev.* **D49** (1994) 6168–6172.
- [64] L. J. Hall, R. Rattazzi, and U. Sarid, *The Top quark mass in supersymmetric SO(10) unification*, *Phys. Rev.* **D50** (1994) 7048–7065, [[hep-ph/9306309](#)].
- [65] M. Carena, M. Olechowski, S. Pokorski, and C. E. M. Wagner, *Electroweak symmetry breaking and bottom - top Yukawa unification*, *Nucl. Phys.* **B426** (1994) 269–300, [[hep-ph/9402253](#)].
- [66] T. Blazek, S. Raby, and S. Pokorski, *Finite supersymmetric threshold corrections to CKM matrix elements in the large tan Beta regime*, *Phys. Rev.* **D52** (1995) 4151–4158, [[hep-ph/9504364](#)].
- [67] S. Antusch and M. Spinrath, *Quark and lepton masses at the GUT scale including SUSY threshold corrections*, *Phys. Rev.* **D78** (2008) 075020, [[arXiv:0804.0717](#)].
- [68] S. Antusch and C. Sluka, *Predicting the Sparticle Spectrum from GUTs via SUSY Threshold Corrections with SusyTC*, *JHEP* **07** (2016) 108, [[arXiv:1512.06727](#)].
- [69] S. Antusch and C. Sluka, *Testable SUSY spectra from GUTs at a 100 TeV pp collider*, *Int. J. Mod. Phys.* **A31** (2016), no. 33 1644011, [[arXiv:1604.00212](#)].
- [70] J. R. Ellis, G. Ridolfi, and F. Zwirner, *Radiative corrections to the masses of supersymmetric Higgs bosons*, *Phys. Lett.* **B257** (1991) 83–91.
- [71] J. R. Ellis, G. Ridolfi, and F. Zwirner, *On radiative corrections to supersymmetric Higgs boson masses and their implications for LEP searches*, *Phys. Lett.* **B262** (1991) 477–484.
- [72] E. Bagnaschi, G. F. Giudice, P. Slavich, and A. Strumia, *Higgs Mass and Unnatural Supersymmetry*, *JHEP* **09** (2014) 092, [[arXiv:1407.4081](#)].
- [73] L. J. Hall, D. Pinner, and J. T. Ruderman, *A Natural SUSY Higgs Near 126 GeV*, *JHEP* **04** (2012) 131, [[arXiv:1112.2703](#)].
- [74] N. Arkani-Hamed, A. Gupta, D. E. Kaplan, N. Weiner, and T. Zorawski, *Simply Unnatural Supersymmetry*, [arXiv:1212.6971](#).
- [75] J. R. Ellis, K. Enqvist, D. V. Nanopoulos, and F. Zwirner, *Observables in Low-Energy Superstring Models*, *Mod. Phys. Lett.* **A1** (1986) 57.

- [76] R. Barbieri and G. F. Giudice, *Upper Bounds on Supersymmetric Particle Masses*, *Nucl. Phys.* **B306** (1988) 63–76.
- [77] N. Craig, *The State of Supersymmetry after Run I of the LHC*, in *Beyond the Standard Model after the first run of the LHC Arcetri, Florence, Italy, May 20-July 12, 2013*, 2013. [arXiv:1309.0528](#).
- [78] B. Batell, G. F. Giudice, and M. McCullough, *Natural Heavy Supersymmetry*, *JHEP* **12** (2015) 162, [[arXiv:1509.00834](#)].
- [79] P. W. Graham, D. E. Kaplan, and S. Rajendran, *Cosmological Relaxation of the Electroweak Scale*, *Phys. Rev. Lett.* **115** (2015), no. 22 221801, [[arXiv:1504.07551](#)].
- [80] J. L. Feng, K. T. Matchev, and T. Moroi, *Focus points and naturalness in supersymmetry*, *Phys. Rev.* **D61** (2000) 075005, [[hep-ph/9909334](#)].
- [81] H. Baer, V. Barger, P. Huang, A. Mustafayev, and X. Tata, *Radiative natural SUSY with a 125 GeV Higgs boson*, *Phys. Rev. Lett.* **109** (2012) 161802, [[arXiv:1207.3343](#)].
- [82] T. J. LeCompte and S. P. Martin, *Large Hadron Collider reach for supersymmetric models with compressed mass spectra*, *Phys. Rev.* **D84** (2011) 015004, [[arXiv:1105.4304](#)].
- [83] J. Fan, M. Reece, and J. T. Ruderman, *Stealth Supersymmetry*, *JHEP* **11** (2011) 012, [[arXiv:1105.5135](#)].
- [84] J. Fan, M. Reece, and J. T. Ruderman, *A Stealth Supersymmetry Sampler*, *JHEP* **07** (2012) 196, [[arXiv:1201.4875](#)].
- [85] R. Barbier *et. al.*, *R-parity violating supersymmetry*, *Phys. Rept.* **420** (2005) 1–202, [[hep-ph/0406039](#)].
- [86] C. Csaki, Y. Grossman, and B. Heidenreich, *MFV SUSY: A Natural Theory for R-Parity Violation*, *Phys. Rev.* **D85** (2012) 095009, [[arXiv:1111.1239](#)].
- [87] M. Papucci, J. T. Ruderman, and A. Weiler, *Natural SUSY Endures*, *JHEP* **09** (2012) 035, [[arXiv:1110.6926](#)].
- [88] S. Dimopoulos and G. F. Giudice, *Naturalness constraints in supersymmetric theories with nonuniversal soft terms*, *Phys. Lett.* **B357** (1995) 573–578, [[hep-ph/9507282](#)].
- [89] A. G. Cohen, D. B. Kaplan, and A. E. Nelson, *The More minimal supersymmetric standard model*, *Phys. Lett.* **B388** (1996) 588–598, [[hep-ph/9607394](#)].
- [90] P. J. Fox, A. E. Nelson, and N. Weiner, *Dirac gaugino masses and supersoft supersymmetry breaking*, *JHEP* **08** (2002) 035, [[hep-ph/0206096](#)].
- [91] G. D. Kribs and A. Martin, *Supersoft Supersymmetry is Super-Safe*, *Phys. Rev.* **D85** (2012) 115014, [[arXiv:1203.4821](#)].

- [92] N. Arkani-Hamed, S. Dimopoulos, and G. R. Dvali, *The Hierarchy problem and new dimensions at a millimeter*, *Phys. Lett.* **B429** (1998) 263–272, [[hep-ph/9803315](#)].
- [93] I. Antoniadis, N. Arkani-Hamed, S. Dimopoulos, and G. R. Dvali, *New dimensions at a millimeter to a Fermi and superstrings at a TeV*, *Phys. Lett.* **B436** (1998) 257–263, [[hep-ph/9804398](#)].
- [94] R. Rattazzi, *Cargese lectures on extra-dimensions*, in *Particle physics and cosmology: The interface. Proceedings, NATO Advanced Study Institute, School, Cargese, France, August 4-16, 2003*, pp. 461–517, 2003. [hep-ph/0607055](#).
- [95] C. Csaki, *TASI lectures on extra dimensions and branes*, in *From fields to strings: Circumnavigating theoretical physics. Ian Kogan memorial collection (3 volume set)*, pp. 605–698, 2004. [hep-ph/0404096](#). [[967\(2004\)](#)].
- [96] N. Arkani-Hamed, S. Dimopoulos, and J. March-Russell, *Stabilization of submillimeter dimensions: The New guise of the hierarchy problem*, *Phys. Rev.* **D63** (2001) 064020, [[hep-th/9809124](#)].
- [97] L. Randall and R. Sundrum, *A Large mass hierarchy from a small extra dimension*, *Phys. Rev. Lett.* **83** (1999) 3370–3373, [[hep-ph/9905221](#)].
- [98] N. Arkani-Hamed, A. G. Cohen, and H. Georgi, *(De)constructing dimensions*, *Phys. Rev. Lett.* **86** (2001) 4757–4761, [[hep-th/0104005](#)].
- [99] L. F. Abbott, *A Mechanism for Reducing the Value of the Cosmological Constant*, *Phys. Lett.* **150B** (1985) 427–430.
- [100] G. Dvali and A. Vilenkin, *Cosmic attractors and gauge hierarchy*, *Phys. Rev.* **D70** (2004) 063501, [[hep-th/0304043](#)].
- [101] G. Dvali, *Large hierarchies from attractor vacua*, *Phys. Rev.* **D74** (2006) 025018, [[hep-th/0410286](#)].
- [102] L. E. Ibanez, M. Montero, A. Uranga, and I. Valenzuela, *Relaxion Monodromy and the Weak Gravity Conjecture*, *JHEP* **04** (2016) 020, [[arXiv:1512.00025](#)].
- [103] D. E. Kaplan and R. Rattazzi, *Large field excursions and approximate discrete symmetries from a clockwork axion*, *Phys. Rev.* **D93** (2016), no. 8 085007, [[arXiv:1511.01827](#)].
- [104] N. Arkani-Hamed, T. Cohen, R. T. D’Agnolo, A. Hook, H. D. Kim, and D. Pinner, *Solving the Hierarchy Problem at Reheating with a Large Number of Degrees of Freedom*, *Phys. Rev. Lett.* **117** (2016), no. 25 251801, [[arXiv:1607.06821](#)].