

FEASIBILITY STUDY FOR THE NOVEL CERN PS FAST EXTRACTION SEPTUM

T. Helseth, M. G. Atanasov, B. Balhan, J. Borburgh, L. Ducimetière, M. A. Fraser, T. Kramer
 CERN, Geneva, Switzerland

Abstract

In the framework of accelerator consolidation, a feasibility study for a novel CERN PS extraction septum has been conducted. Functional requirements have been established and, accordingly, a system of two septa magnets and their associated pulse generator is proposed. The magnetic septum design is based on eddy current topology. Magnetic simulations in Flux 2D and Opera 3D of a conceptual design have been carried out. The short length and high amplitude of the current pulse required to drive the eddy current septa imply that none of the power converters currently used for septa magnets at CERN will be suitable. Pulse generator topologies derived from kicker generators have therefore been explored and simulated in Spice. The conceptual magnet and generator design along with simulation results are presented in this paper.

INTRODUCTION

The fast CERN PS extraction septum (PE.SMH16) deflects protons and ions into the extraction transfer line TT2 (otherwise known as F16) from SS16 towards the experimental areas of the PS complex and the SPS. When the PS extraction septum was put into service in 1994, the lifetime of each magnet was ~5-6 years. Nowadays, with the increased number of extractions, the lifetime is getting very close to < 2 years. This implies annual refurbishment of the septum and a significant dose taken by personnel. Additionally, the present power converter is approaching the end of its life. In view of its superior robustness, an eddy current septum system is presently being considered as the most suitable design choice for consolidation.

MAGNET DESIGN

In an attempt to cut cost and reduce lead time, it is envisaged to reuse the existing vacuum vessels and remote displacement systems. This constrains the dimensional envelope of the new magnet to that of the existing magnet assembly. The proposed system is composed of two 1125 mm long laminated yoke septa magnets with a 20 mrad angle between them. The copper septum blade is 3 mm thick for almost the full aperture height and widens to 9 mm above and below the aperture. When operating at nominal current, the field in the gap is about 1.2 T, and the resulting integrated field in the septum is 2.6 Tm. The main parameters and requirements of the magnet are given in Table 1. As this is an extraction septum, only the leak fields up until the time of extraction are of interest, and the requirements specified are therefore not global maximum values, but maximum values only within the period of interest. The field quality

requirements used in this article are derived from the field quality needed across the beam to limit the relative emittance growth of the beam to a set threshold. For the LHC beam this threshold is 1 %. The emittance growth calculation is based on a thin lens approximation [1]. Equation (1) shows the relationship between the emittance growth and field quality. As this calculation takes into account the size of the beam and since different beams will have different relative emittance growth thresholds, this means that different beams will have different field quality requirements.

$$\Delta\epsilon = \frac{1}{2}\theta^2 \left(\frac{\Delta B}{B}\right)_{rms}^2 \beta, \quad (1)$$

where:

θ : Nominal deflection angle

$\left(\frac{\Delta B}{B}\right)_{rms}^2$: RMS field ripple across the beam

β : Twiss parameter at entry to septum.

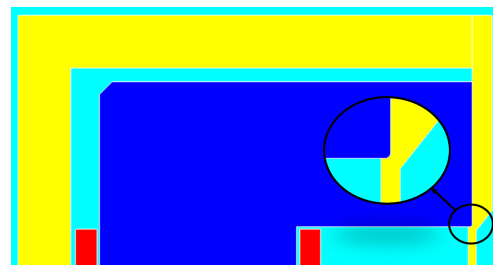

Figure 1: Top half cross-section of proposed magnet with zoom of the inset feature.

Figure 1 shows the cross-section of the proposed magnet. A novel feature of this design is the inset of the yoke into the septum blade. The initial design used a straight septum blade modelled after the new eddy current CERN PS injection septum (PI.SMH42) [2]. This design did not manage to reach the field quality required for the low emittance LHC beam close to the blade, it did however meet the less stringent requirement for the Multi Turn Extraction (MTE) beam. The reason behind the poor field quality of the initial design was identified as a flux concentration in the yoke. The proposed design with the inset into the blade helps mitigate this flux concentration, and in turn improves the homogeneity in the aperture close to the blade. The ends of the magnets are shielded by end plates made up of 15 mm copper and 5 mm magnetic steel. The copper and magnetic steel in the end plates are not in electrical contact with each other.

Table 1: Main Parameters

Parameter	Unit	Value
Peak field at 26 GeV/c	T	1.196
Peak current at 26 GeV/c	A	28550
Magnetic length	m	2.174
$\int Bdl$ at 26 GeV/c	Tm	2.6
Septum blade thickness	mm	3
Aperture height	mm	30
Aperture width	mm	56
Leak field at 10 mm	%	1
Leak field at 50 mm	%	0.1
Field quality		$< 3 * 10^{-4}$ (LHC) $< 10^{-3}$ (MTE)
Flat top length	μs	2 - 10
Repetition period	s	1.2

PULSE GENERATOR DESIGN

To meet the requirements outlined in Table 1, a 200 μs half sine with a superimposed 3rd harmonic has been chosen as the preferred current pulse. The choice of pulse length is driven by the ratio between the thickness of the septum blade and the skin depth of the septum blade material at a given pulse length. Higher ratios will generally improve the shielding performance of the septum. As the septum thickness and material are fixed parameters in this study, the only variable in the ratio is the pulse length. Shorter pulse lengths, and in turn smaller skin depths, would be beneficial from a leak field perspective as the septum blade will better shield the magnetic field, but this comes at the cost of higher voltages over the magnet and might also warrant the use of even thinner yoke laminations. The 200 μs pulse length is therefore a compromise taking into account several different factors. This pulse shape can be achieved using the capacitor discharge circuit described in Fig. 2. Figure 3 shows the simulated pulse produced by the circuit. The circuit is derived from the power converter design used for the prototype fast pulsed eddy current septum magnet for SPS extraction (MSP) [3]. A noticeable difference between the MSP circuit and the proposed circuit is the individual switch for each capacitor bank. This is a switch topology derived from the KEK Low Field Septum Magnet [4]. By applying a relative dephasing to the switch timing, a certain degree of adjustability can be achieved without resorting to variable passive components. Component variation can be caused by age degradation, radiation degradation, thermal dependencies, or other factors. The MSP circuit relied on a variable inductor to account for variations in component values, but this proved challenging and should if possible be avoided in the future. Figure 4 shows the dephasing feature employed to correct for a 20 % decrease in capacitance for the C_1 capacitor bank. Note that for such extreme component variations, the pulse length and maximum current will also be altered. The maximum current can easily be adjusted for by changing the charging voltage, but a change in pulse

length can not be accounted for with this circuit design. The generator is bipolar with ground in the centre of the two magnets, thus halving the absolute voltage between the magnet and ground when compared to a unipolar generator. A similar grounding scheme is also used for the SPS beam dump kicker system [5]. This does however mean that during the charging of the capacitors there is going to be a current, and a resulting magnetic field, in one of the magnets, but as the charging current is very low compared to the nominal current this is not considered to be a problem.

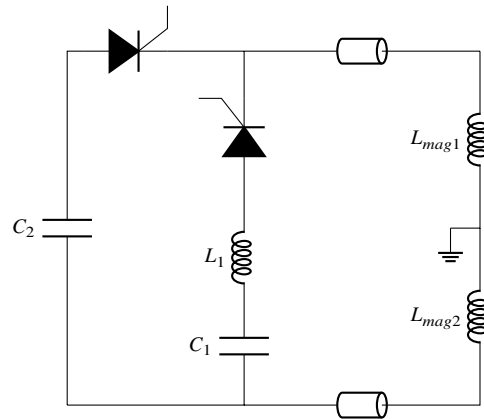

Figure 2: Conceptual circuit diagram.

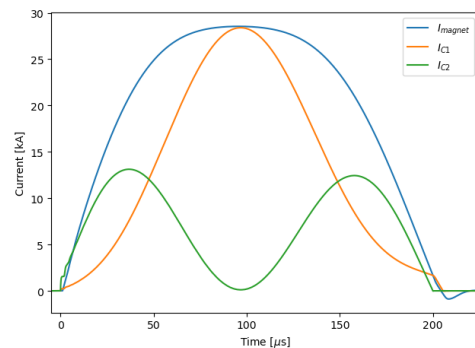

Figure 3: Current pulse through the magnet produced by the circuit described in Fig. 2. Also shown are the current outputs from the two capacitor banks.

MAGNETIC FIELD SIMULATIONS

2D

Using the cross section presented in Fig. 1, 2D transient simulations with a 200 μs half sine pulse have been conducted using Altair Flux 12.3.1.

3D

A single magnet module, 1125 mm in length, has been modelled using Simulia Opera with a 200 μs half sine current pulse. Eddy currents in the coil and yoke assembly are not included in this 3D model due to the computational overhead required.

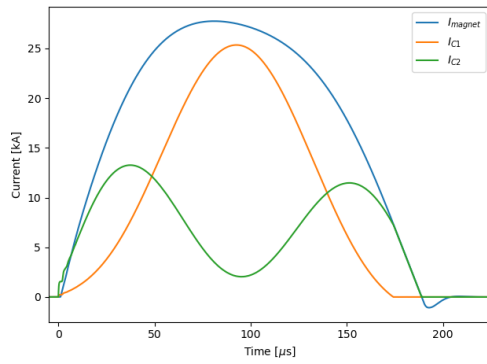

(a) Without dephasing between the switches.

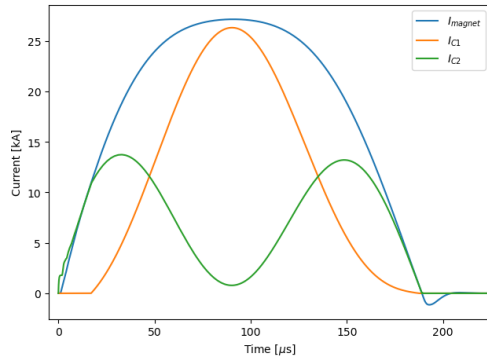

(b) With a 17 μs relative dephasing between the two switches.

Figure 4: Current pulse through the magnet for a circuit with a 20 % decrease in C_1 compared to the nominal value used for the simulation shown in Fig. 3 with and without a 17 μs relative dephasing between the two switches.

Simulation Results

The leak fields for both 2D and 3D simulations are presented in Fig. 5. For the 3D simulation several data points are calculated up until the time of extraction. The observable difference between the 2D and 3D leak results is most likely caused by effects at the end of the magnet that only the 3D model is able to include. From these simulations it appears that the design meets the requirements specified in Table 1 until the time of extraction. The 2D results show that the leak field is expected to rise above the maximum leak field specified, but this is after the beam has been extracted, and is therefore acceptable. The 3D simulation homogeneity in the aperture for a LHC beam at the moment of extraction is presented in Fig. 6. For large parts of aperture the field quality is within the requirement, but the homogeneity clearly degrades towards the rear of the aperture close to the coil. Figure 7 shows the homogeneity results at the moment of extraction for both 2D and 3D simulations over the width of the aperture in the midplane. Note the distinct difference in homogeneity towards the rear of the aperture for the 2D and 3D simulations, which is most likely a result of neglecting the skin effect within the coil for the 3D simulation.

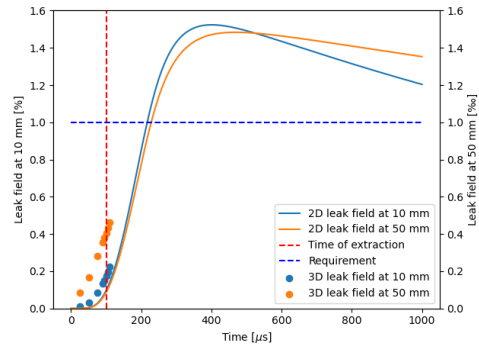

Figure 5: Leak field at 10 mm and 50 mm from the septum blade for 2D and 3D simulations.

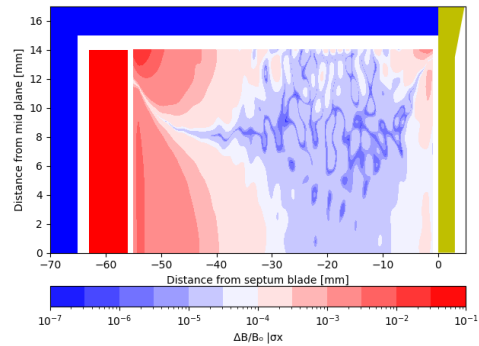

Figure 6: 3D simulation homogeneity $\frac{\Delta B dl}{B_0}$ for LHC beam.

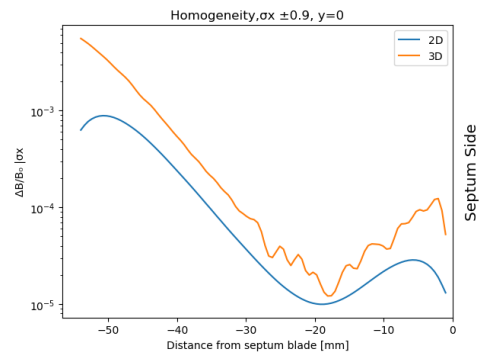

Figure 7: $\frac{\Delta B}{B_0}$ and $\frac{\Delta B dl}{B_0}$ homogeneity for LHC beam along the midplane for 2D and 3D simulations.

CONCLUSION AND OUTLOOK

This feasibility study has shown that from an electromagnetic standpoint it should be possible to replace the current SMH16 extraction septum with an eddy current septum and take advantage of the improved robustness of this magnet topology. A suitable pulse generator topology has also been found. There are still challenges to surmount with the mechanical design, especially with regards to the high voltages that are inherent to fast pulsing magnets, and the control system for the pulse generator. It is foreseen to construct a prototype by 2022 and have a septum magnet ready for PS installation in 2024.

REFERENCES

- [1] M. Giovannozzi, A.-S. Mueller, and M. Martini, “A Low-[beta] Stripping Insertion in the CERN PS to SPS Transfer Line for the LHC Ion Programme”, in *Proc. 19th Particle Accelerator Conf. (PAC’01)*, Chicago, IL, USA, Jun. 2001, paper TPAH143, pp. 1550–1552.
- [2] M. Hourican, B. Balhan, C. C. M. Borburgh, T. Masson, and A. Sanz Ull, “Validation of the CERN PS Eddy Current Injection Septa”, in *Proc. 9th Int. Particle Accelerator Conf. (IPAC’18)*, Vancouver, Canada, Apr.-May 2018, pp. 768–771. doi:10.18429/JACoW-IPAC2018-TUPAF037
- [3] E. Carlier *et al.*, “A Novel Eddy Current Septum Magnet for SPS Extraction towards LHC and CNGS”, in *Proc. 7th Euro-pean Particle Accelerator Conf. (EPAC’00)*, Vienna, Austria, Jun. 2000, paper TUP7B04, pp. 2370–2372.
- [4] T. Shibata, K. Ishii, H. Matsumoto, N. Matsumoto, T. Sugimoto, and K. Fan, “The Development of a New Low Field Septum Magnet System for Fast Extraction in Main Ring of J-PARC”, in *Proc. 7th Int. Particle Accelerator Conf. (IPAC’16)*, Busan, Korea, May 2016, pp. 1340–1342. doi:10.18429/JACoW-IPAC2016-TUPMR040
- [5] J. Bonthond, L. Ducimetiere, P. Faure, and E. B. Vossenberg, “High power semiconductor switches in the 12 kV, 50 kA pulse generator of the SPC beam dump kicker system”, in *Proc. PPS’2001*, Las Vegas, USA, Rep. CERN-SL-2001-015-BT, Jun. 2001.