



CERN-PBC-NOTE-2022-005

2022-03-30

a.ge@cern.ch

Integration Studies and Beam Physics for the Project of the NA60+ Heavy-Ion Experiment at CERN

A. Gerbershagen^{1,2}, C. Ahdida¹, J. Bernhard¹, V. Clerc¹, S. Girod¹, E. Scomparin³, G. Usai⁴, H. Vincke¹

¹ European Organisation for Nuclear Research (CERN), Meyrin, Switzerland

² PARTREC, UMCG, University of Groningen, The Netherlands

³ INFN Sezione di Torino, Turin, Italy

⁴ Dipartimento di Fisica dell' Universita' di Cagliari and INFN Sezione di Cagliari, Cagliari, Italy

Keywords: Heavy ions, Fixed target experiment, Beam lines, NA60+, EHN1.

Abstract

NA60+ is a fixed target experiment proposed in the framework of the Physics Beyond Colliders programme at CERN. It aims to precisely measure the hard and electromagnetic probes in nuclear collisions. Initially proposed for the underground cavern ECN3 with very high beam intensities, the experiment now foresees a location in the EHN1 surface hall which was shown to have a limited impact on the physics performance in spite of a significant reduction of beam intensity and detector size. The potential installation and operation of the experiment with the ion beams from the Super Proton Synchrotron (SPS) has been examined regarding detector integration, beam physics, radiation protection and shielding requirements. The integration of the experiment is considered feasible and would require a significant reconfiguration of the zone in regard to shielding and layout. The first estimate for the integration cost is 1.4 MCHF.

Contents

1	Introduction	1
1.1	Physics Beyond Colliders.....	1
1.2	NA60+ Experiment	1
1.3	Current EHN1 hall layout.....	2
2	Proposed Beam Set-Up	3
3	Zone Layout and Integration Studies	7
4	Radiation Protection Studies	9
4.1	Shielding Layout	9
4.2	Prompt Dose Rates	10
4.3	Residual Dose Rates	12
4.4	Air Activation.....	13
4.5	Accidental Beam Loss.....	15
5	Conclusions: Feasibility Evaluation and Cost Estimation.....	16
6	Acknowledgement.....	17
7	References	17

1 Introduction

1.1 Physics Beyond Colliders

Physics Beyond Colliders (PBC) (Jaeckel, Lamont, & Vallée, 2020) is a study initiated at CERN in 2016 to explore the possibilities of fundamental physics research complementary to that at existing or future colliders. A considerable share of the proposed programme focusses on fixed target experiments to be located in CERN North Experimental Area supplied by beam from the CERN Super Proton Synchrotron (SPS). Many experimental proposals have been analysed by the PBC Conventional Beams Working Group (D.Banerjee, et al., 2018). This analysis includes an evaluation of the feasibility and cost of the integration of the experiment from the mechanical, topological and radiation protection point of view. It does not cover the physics scope of the experiment or the feasibility or performance of its detectors.

1.2 NA60+ Experiment

The NA60+ experiment (Dahms, Scomparin, & Usai, 2019) is proposed to study the production of thermal dimuons and open charm using a primary ion beams from the SPS in the momentum range of 30-158 A GeV/c.

The latest schematic layout of the detector is shown in Figure 1. It consists of a target located inside a dipole magnet (MEP48) followed by a silicon vertex spectrometer, an absorber, a muon spectrometer combining a normal conducting toroidal magnet with five tracking stations and a muon wall. The transverse size of the detector has been reduced from the initial value proposed of 9.0 m in (Dahms, Scomparin, & Usai, 2019) to a value of 6.2 m, without a noticeable reduction in the physics reach. The length of the detector can vary between 10.4 m for low momenta to 13.7 m for the higher momenta, for which the downstream part of the detector, consisting of the detector planes, toroidal magnet and the muon wall, needs to be movable (see a possible integration solution in Section 3 of the present article).

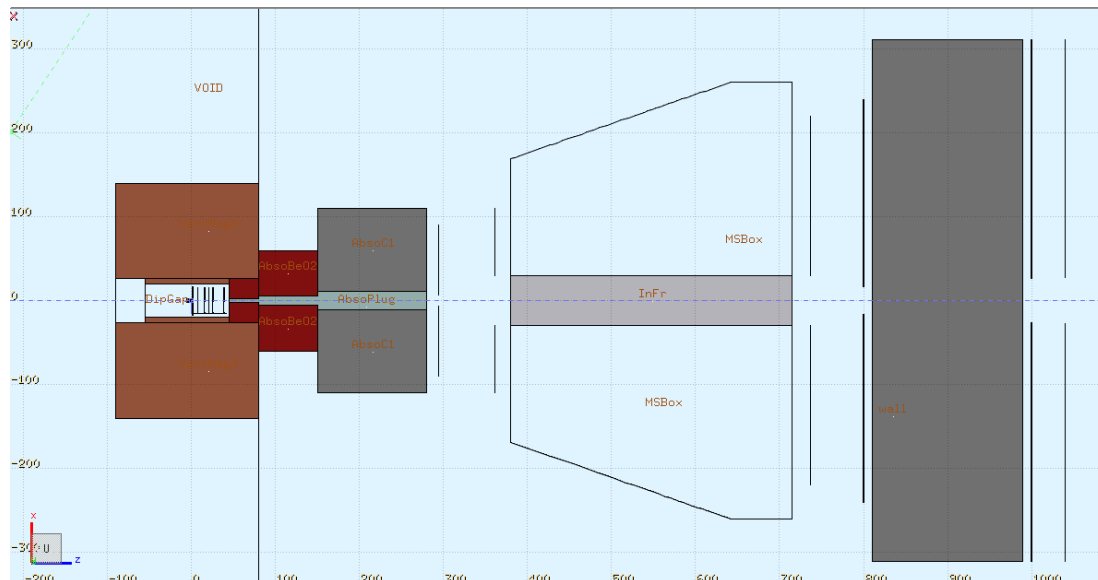

Figure 1: Schematic layout of NA60+ experiment. Brown color represents the yoke of the magnet around the target. The absorber material is depicted in red and grey, followed by toroidal magnet (colourless) and muon wall (grey).

1.3 Current EHN1 hall layout

CERN North Area (Banerjee, et al., 02 Jul 2021) receives proton or ion beam from the SPS accelerator. The primary SPS beam is separated in three beams at the so-called splitters (see Figure 2). Those beams can be either transported to the Experimental Areas as a primary beams or scattered at the targets for the generation of the secondary beams. The beam lines H2, H4, H6 and H8 lead to the Experimental Hall North 1 (EHN1), M2 leads to Experimental Hall North 2 (EHN2) and the P42 and K12 beam lines lead to Experimental Cavern North 3 (ECN3).

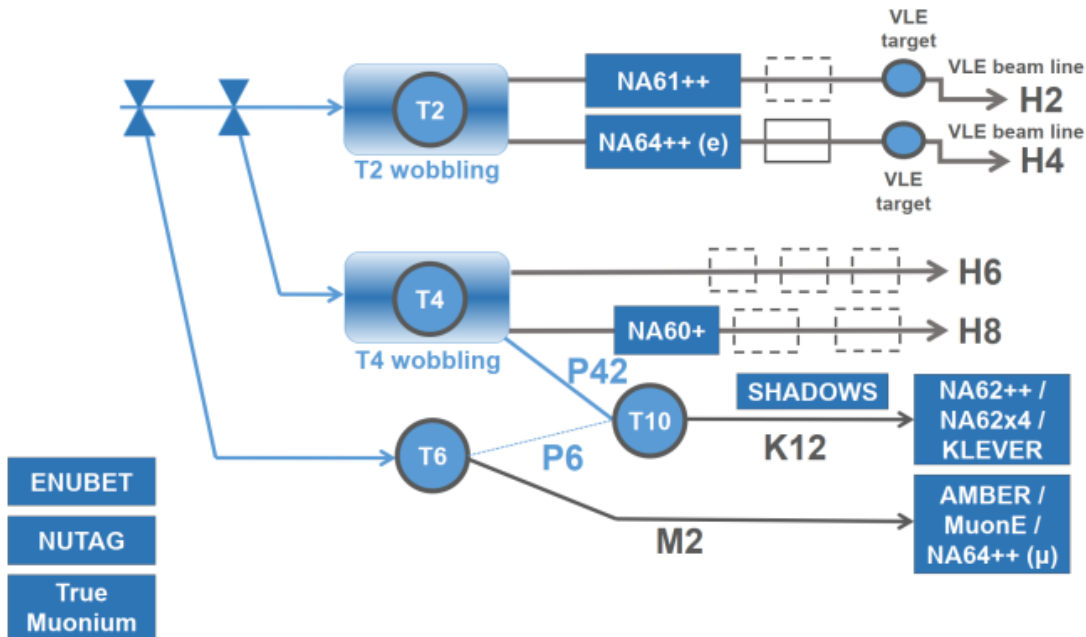

Figure 2: Schematic diagram of the North Area beam lines (apart from TT20 tunnel) and the experiments proposed in the framework of the Physics Beyond Colliders programme.

Several locations have been considered for accommodating the NA60+ detector in the North Experimental Area. These include an initially proposed location in the underground ECN3 cavern for high intensities, and several zones of the EHN1 surface hall, including the PPE138 zone of the H8 beam line. Locations in the EHN1 surface hall can only be considered for lower beam fluxes of up to $1e7$ Pb ions per spill. Figure 3 shows the layout of the EHN1 hall and indicates the user zones within the hall. The four beamlines H2, H4, H6 and H8 transverse the hall from the left towards the right side of the diagram. Their user zones are marked by green, blue, violet and red colours, respectively.

Zone PPE138 (in the bottom left quarter of Figure 3) was identified to be the most promising candidate, considering the absence of other major fixed target experiments in this beamline (competing for space and beam time), and the full spectrum of requests within the PBC programme for the other zones.



Figure 3: Layout of the upstream part of EHN1 hall with its user zones.

The beam enters the zone from the left side and travels towards the right. In order to accommodate the experiment, the zone would need to be substantially modified with regards to its shielding, access and layout. The reasons behind these modifications and the details of the modification will be described in the following sections.

2 Proposed Beam Set-Up

The slow extraction of the ions from the SPS into the CERN North Area is performed through debunched spills of about 10 s duration. The maximal duty cycle is 50% and consists of two spills within a supercycle interval of 40 seconds. This value has been taken as a baseline for the investigation of Radiation Protection (RP) related issues, beam optics calculation and the integration design.

The beam intensity required to fulfil the NA60+ physics programme in EHN1 is 10^7 primary lead ions per spill at the target of NA60+, which corresponds to $5 \cdot 10^5$ ions per second (or 10^6 ions per second with 50 % duty cycle). The beam spot size at the experiment needs to be as small as possible, with the beam fitting within a 4 mm hole in the central part of the detector.

The requested beam intensity can routinely be delivered by the accelerator chain and strong collimation will be needed to reduce the intensity delivered to 10^7 ions per spill at the experiment, where the intensity is limited by the RP considerations. The beam parameters at the beginning of the H8 transfer line are not well known due to the lack of precise beam instrumentation. At the T2 target, where the beam conditions are not identical, but comparable, a measurement of the beam size was performed in 2017, showing that the 150A GeV/c lead ion beam had the profile displayed in Figure 4, with an overall beam size of approximately 1x1 mm.

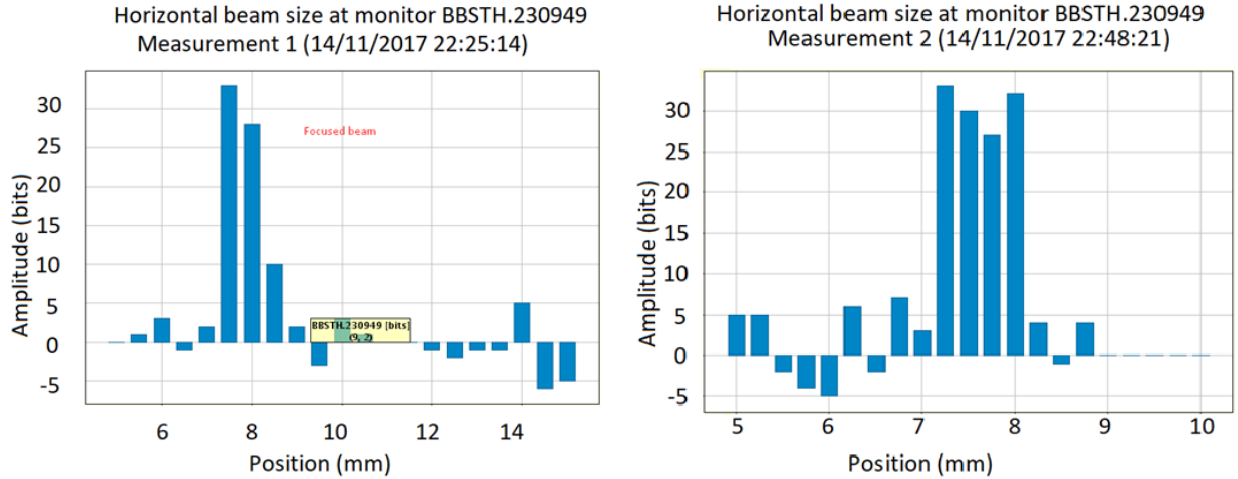

Figure 4: Histogram profile of 150A GeV/c lead ion beam measured at the T2 target location [courtesy N. Charitonidis]

Based on this measurement and for the purpose of this study, a conservative assumption has been made that the 150A GeV/c lead ion beam at the T4 location would have an RMS beam size of 0.5 mm (full size of ~ 2 mm) and that the beam divergence has a comparably large RMS value of 0.5 mrad (see Table 1). In order to estimate the values for a low energy beam of 30A GeV/c, only the geometrical change of divergence (proportional to $1/\sqrt{p}$) has been considered. In reality, additional changes of beam size and divergence can be expected due to the limited precision of SPS rectifiers and the reduced response from the beam instrumentation at lower momenta, which can impede the beam steering and aggravate the beam losses. However, the exact amount of their contribution is difficult to estimate. The difference in the SPS beam divergence translates into the beam size difference at the T4 target location, since it is a focal point of the beam optics, in which the beam size is determined by the overall beam emittance. It should also be noted that the RMS of the initial beam divergence is a less important parameter for the estimation of the beam size, since the maximal divergence is limited by the H8 beamline acceptance, which itself is dependent on the apertures and optics settings of the beamline. The initial divergence is, however, relevant for the estimation of the relative transmission through the H8 beamline for the different beam optics options.

Table 1: Assumptions of initial lead ion beam parameters at the start of the H8 beamline

Parameter	160A GeV/c	30A GeV/c
σ_x, σ_y (mm)	0.5	1.15
σ_{px}, σ_{py} (mrad)	0.5	0.5
σ_p/p (%)	0.1	0.1

The currently used beam optics settings would deliver a beam with an RMS transverse size of 0.8 mm at the location of the experiment, which is larger than requested by NA60+. Hence, two new optics settings have been developed, with the aim of reducing the beam size. Both optics versions are achromatic to first order. One is based on the use of the so-called Microcollimator – a very small and precisely aligned collimator used for the primary proton beam operation in H8. It provides high beam stability, since the beam is imaged from the well-defined physical gap of the Microcollimator to the

location of the experiment. However, the transmission is low, defined by the Microcollimator aperture. The setting of the Microcollimator gap can be directly used to modify the beam size at NA60+.

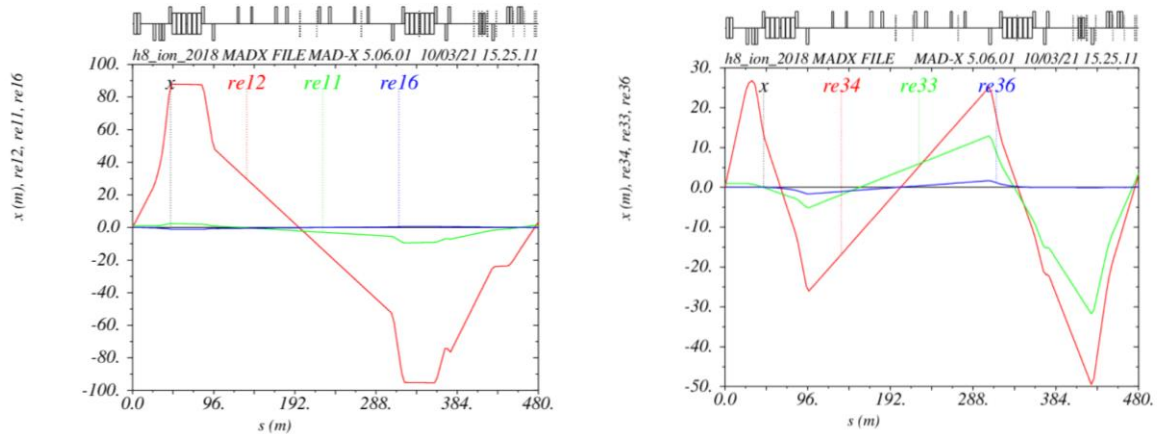

Figure 5: Optical transfer matrix functions for the horizontal (left) and vertical (right) plane for the new Microcollimator ion beam optics for NA60+. Horizontal axis is the position in meters along the H8 beamline. Green, red and blue curves signify the contribution to the beam size at a given location of the initial beam size, beam divergence and momentum spread, respectively.

The second optics does not use the Microcollimator, but instead relies on stronger focussing of the beam at the experiment location (see Figure 5). It has the large advantage of allowing much higher transmission of the beam to the experiment location without compromising the beam size and is hence currently the preferred option.

The resulting beam size at the experiment location and transmission through the H8 beamline are summarized in Table 2 and Figure 6. It should be noted that these results are based on optimistic assumptions about the beam size at the target and ignore the effects of beam transport and scattering in air and in the beam line diagnostics elements.

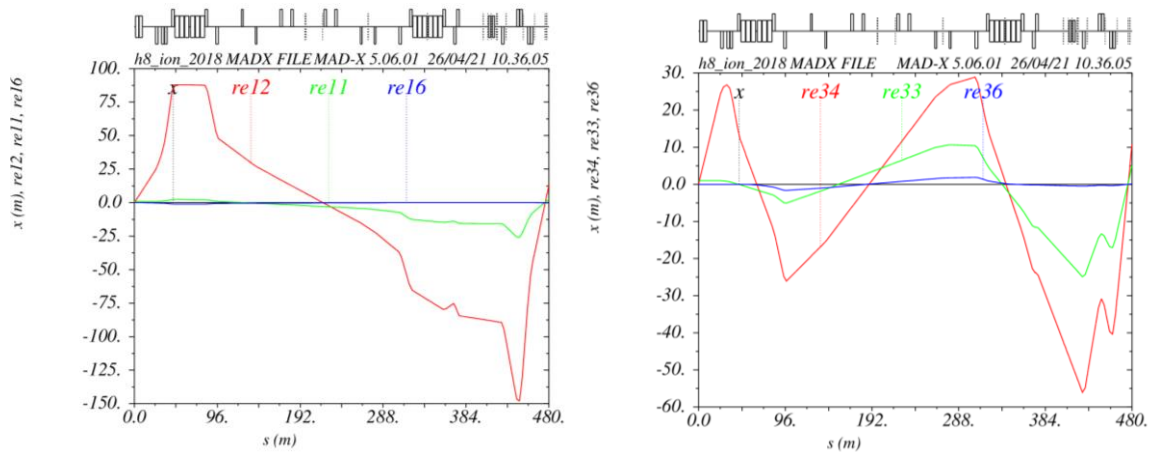

Figure 5: Optical transfer matrix functions for the horizontal (left) and vertical (right) plane for the new, strongly focussed ion beam optics for NA60+. Horizontal axis is the position in meters along the H8 beamline. Green, red and blue curve signify the contribution to the beam size at a given location of the initial beam size, the beam divergence, and the momentum spread, respectively.

Table 2 a: Summary of beam parameters at the potential location of NA60+ for Microcollimator design

Parameter	160A GeV/c	30A GeV/c
σ_x (mm)	0.33	0.35
σ_y (mm)	0.34	0.36
Transmission from the start of the H8 beamline (%)	12.22	2.91

Table 2 b: Summary of beam parameters at the potential location of NA60+ for the focusing optics design

Parameter	160A GeV/c	30A GeV/c
σ_x (mm)	0.19	0.33
σ_y (mm)	0.19	0.36
Transmission from the start of the H8 beamline (%)	32.43	23.5

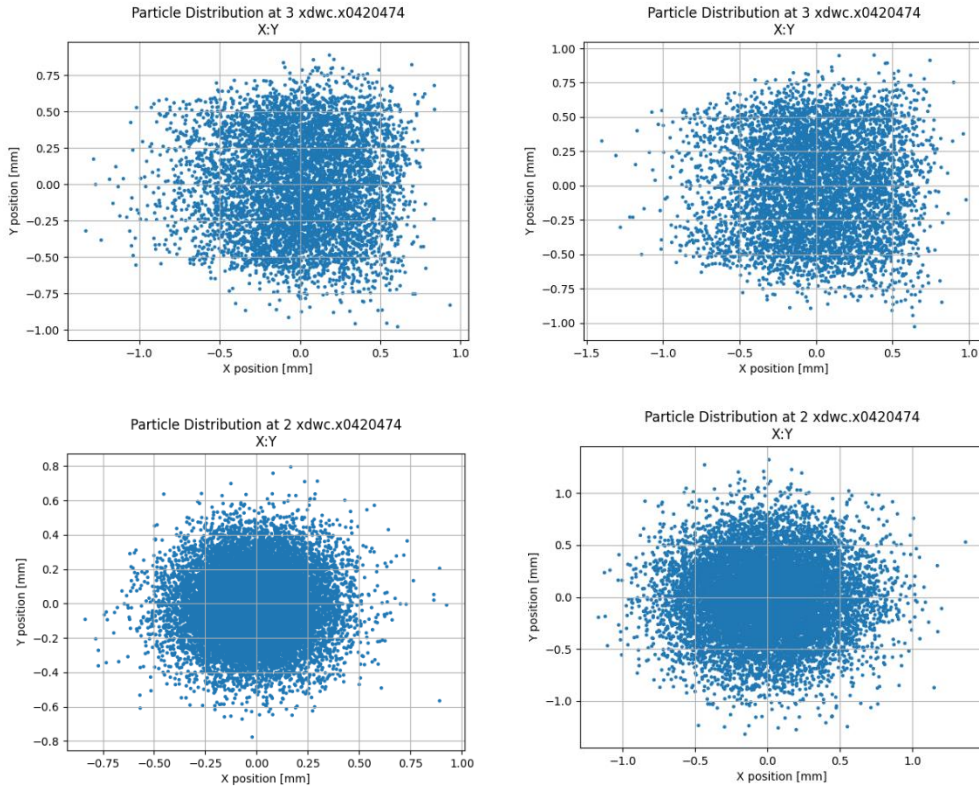

Figure 6: Beam spot distribution for the Microcollimator (top) and new focussing (bottom) optics for the beams of 160 AGeV/c (left) and 30 AGeV/c (right) momentum.

3 Zone Layout and Integration Studies

Currently, the zone foreseen for NA60+ installation is utilized to provide test beams to several users and is therefore not optimally laid out for the installation of a major detector. An integration study has been conducted, revealing that the placement of the newly proposed reduced size NA60+ detector (radius of 3.1 m and maximal length of 13.7 m) is feasible, provided that the zone is substantially modified. The 3D-drawing of the modified design is displayed in Figures Figure 7, Figure 8 and Figure 9.

The shielding wall separating the experimental area from the user zones of the H6 beam line, will have to be moved by 80 cm towards the H6 beam line, which does not present a major problem. A new bridge and stairs to access the detector will also need to be installed (depicted green in Figure 7). Since the H8 beam height above the hall ground is 2.88 m, an excavation needs to be performed for accommodating a detector with 3.1 m radius and its mounting structure. The depth of the excavation has been set to 1 m and the transverse dimension to 6 m. The longitudinal extent of the excavation needs to cover the two setup lengths, the short one (10.4 m total length, see Figure 7) for the low energy run and the full length one (13.7 m total length, see Figure 8) for the high energy run. Rails must be installed on the bottom of the excavated area to enable the longitudinal movement of the toroidal magnet and of muon wall for the modification of the setup between the short and the long version.

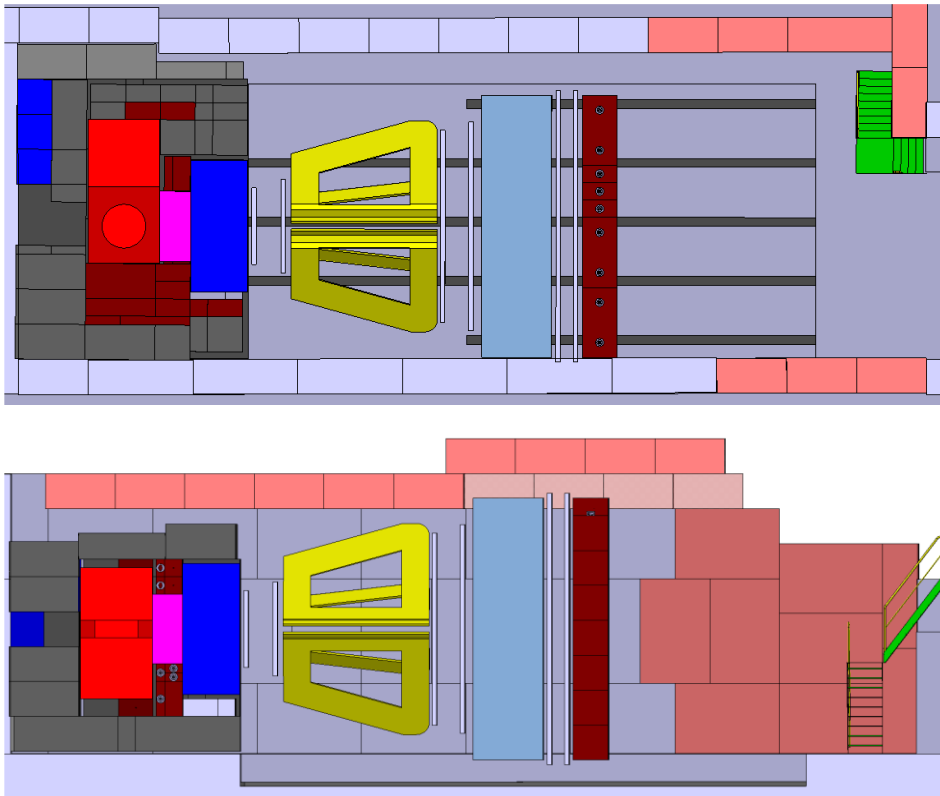

Figure 7: Drawing of the short (10.4 m) setup of NA60+ installed in the modified PPE1138 zone, top view (top) and side view (bottom)

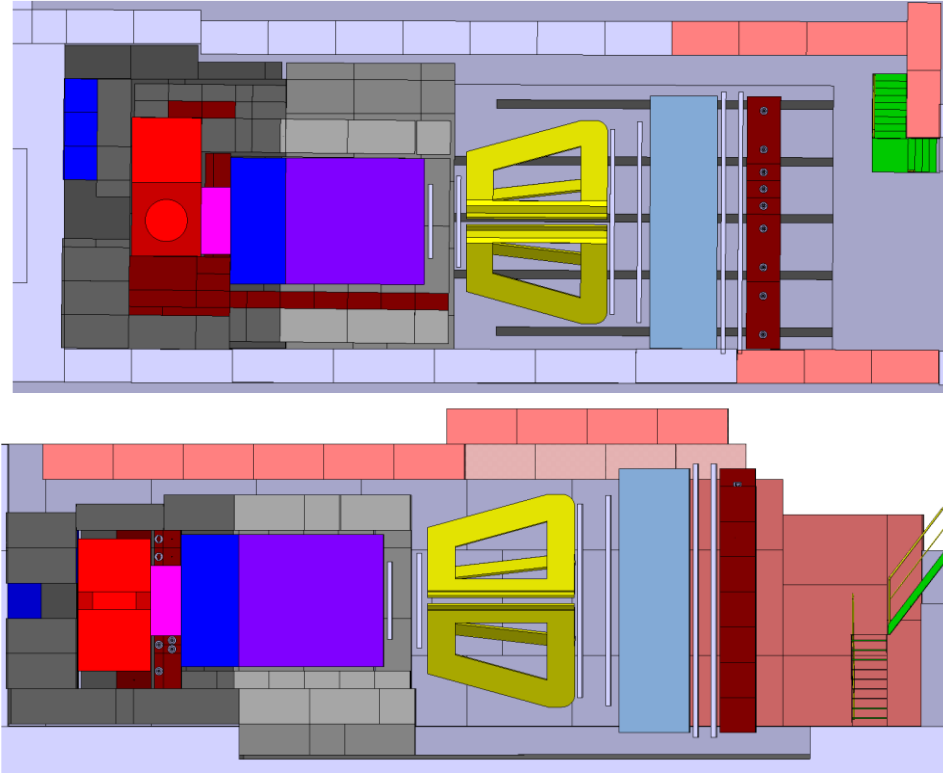

Figure 8: Drawing of the long (13.7 m) setup of NA60+ installed in the modified PPE1138 zone, top view (top) and side view (bottom)

The dipole magnet around the NA60+ target is shown in Figure 7 and Figure 8 in light red colour. The integration includes the installation of the additional shielding, required due to the radiation protection considerations described in Section 4. It includes the concrete and iron shielding blocks in the region around the target and behind the muon wall, marked as grey and dark-red blocks in Figure 7 and Figure 8, as well as the installation of the roof shielding, shown in Figure 9.

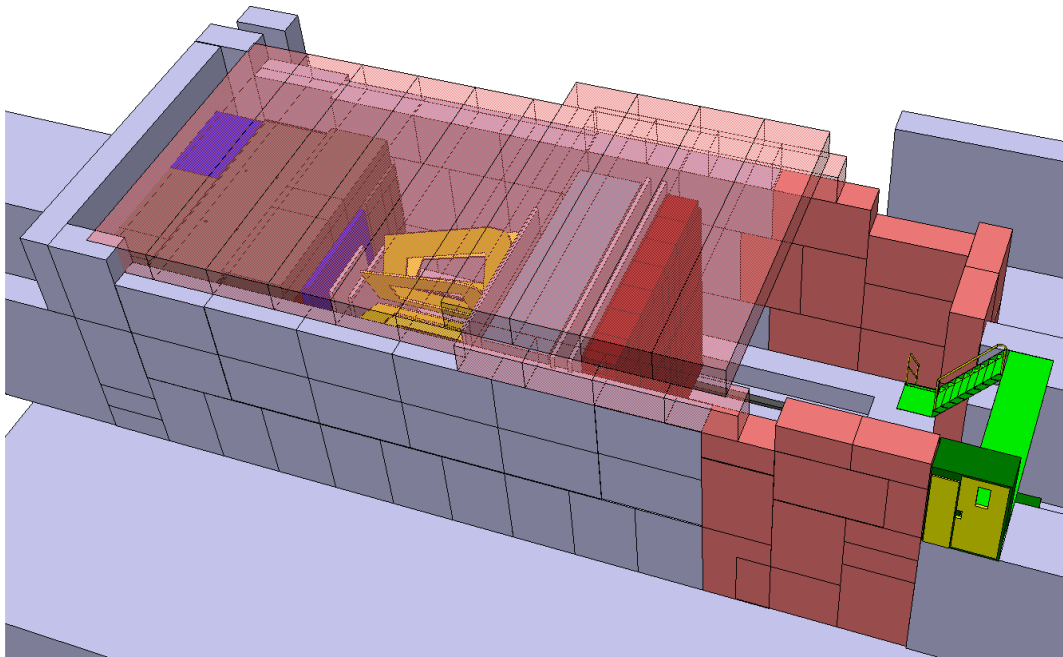

Figure 9: 3D drawing of zone PPE138 with NA60+ detector and the additional shielding

4 Radiation Protection Studies

Since NA60+ aims at pushing the beam intensity by at least one order of magnitude with what is currently delivered to EHN1, a detailed radiation protection assessment needed to be performed. The area surrounding the proposed location of NA60+ is classified according to CERN's radiological classification (D. Forkel-Wirth, EDMS 810149) as a Supervised Radiation Area with a low occupancy zone on one side (15 $\mu\text{Sv/h}$ limit) and permanent workplaces on the other (3 $\mu\text{Sv/h}$ limit). The shielding structure therefore has to be designed in such a way as to sufficiently reduce the prompt radiation to be compatible with the ambient dose equivalent rate limits linked to the area classification. The residual dose rates and air activation were also analysed, along with accidental beam losses in the beamline upstream of the experiment. The assessment was based on the FLUKA Monte Carlo particle transport code (<https://fluka.cern>, n.d.; Ahdida et al., *Frontiers in Physics* 9, 788253 (2022); Battistoni, et al., *Annals of Nuclear Energy* 82, 10-18 (2015)). FLUKA is a valuable tool used at CERN for various applications including radiation protection studies (Ahdida, et al., CERN-PBC-CONF-2019-001, 2019; Nakao et al., *Nucl. Instrum. Methods Phys. Res. B*, 266 (2008), pp. 93-106) and benchmarking activation studies (Iliopoulou, et al., *Nucl. Instrum. Methods Phys. Res. A*, 885 (2018), pp. 79-85; Ahdida, Froeschl, Iliopoulou, Infantino, & Jensen, *Nuclear Inst. and Methods in Physics Research, A* 950 (2020) 162972; Iliopoulou et al., *J. Phys.: Conf. Ser.*, 1046 (2018), Article 012004). The given FLUKA simulations were performed using the latest released version (FLUKA 4-1.0), while the geometry was created using Flair (Vlachoudis, *Proc. Int. Conf. on Mathematics, Computational Methods & Reactor Physics (M&C 2009)*, Saratoga Springs, New York, 2009).

4.1 Shielding Layout

The final shielding layout for NA60+ for the case of 160 A GeV/c is depicted in Figure 10. In the most critical region around the target and the absorber a first layer of iron shielding, providing a higher attenuation of the radiation than concrete shielding, was implemented, which is then followed by additional concrete shielding. A chicane upstream of the target was added to allow access to the target region under certain conditions. A concrete shielding roof spanning the whole detector setup was added to reduce skyshine radiation.

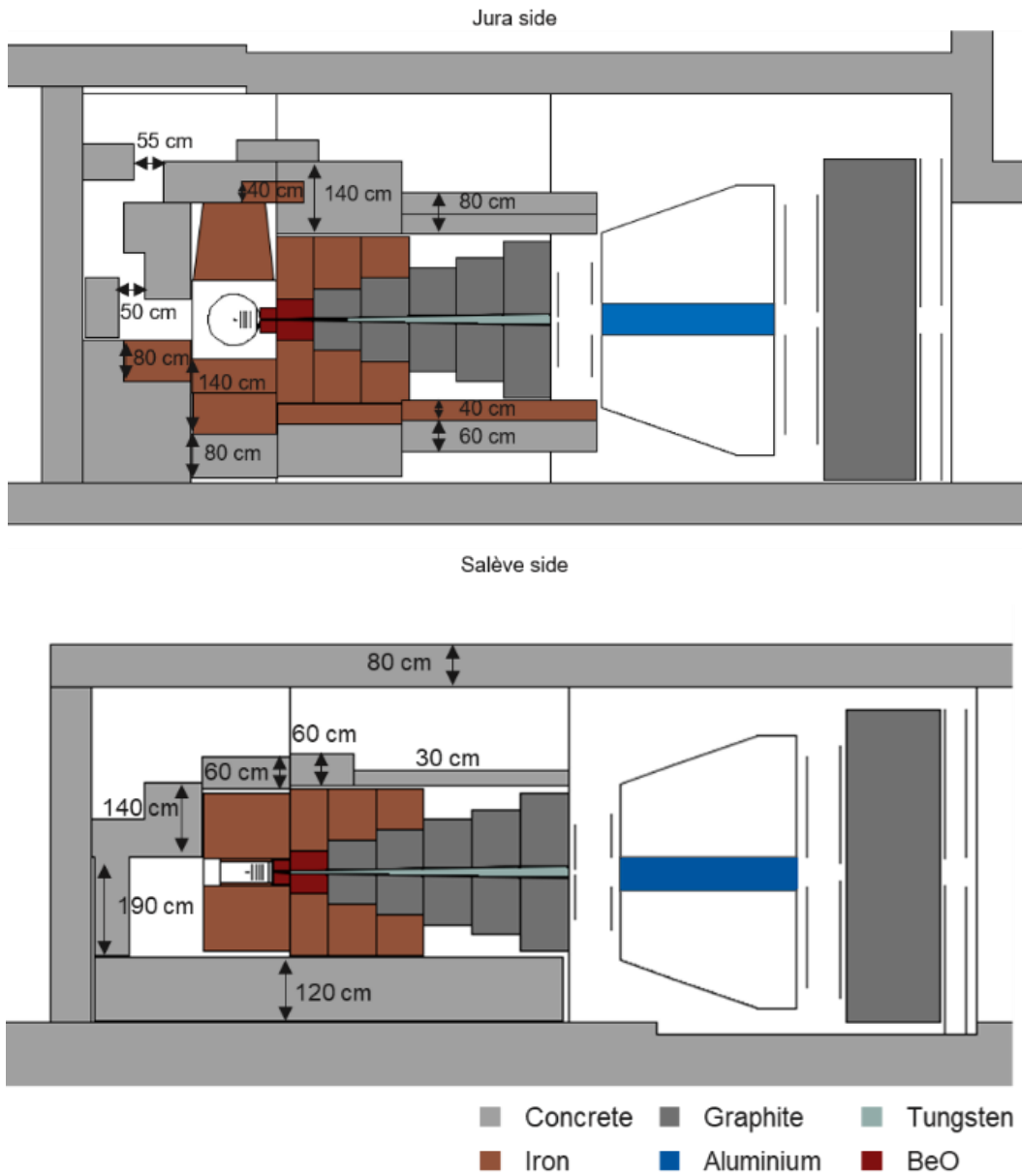

Figure 10: Shielding layout of NA60+ for 160A GeV/c as implemented in FLUKA with view from the top (top) and from the side (bottom) (Dahms, Scomparin, & Usai, 2019).

4.2 Prompt Dose Rates

Figure 11 and Figure 12 depict the prompt ambient dose equivalent rate distributions $H^*(10)$ (used as a standard quantity by CERN RP) for the experimental zone and its surroundings. It shall be noted that due to large uncertainties in the concrete density, a safety factor of 3 was taken into account, meaning that the displayed doses are 3 times greater than the simulation output for nominal intensity. The results show that the shielding allows sufficient reduction of the ambient dose rates to comply with the $3 \mu\text{Sv/h}$

and $15 \mu\text{Sv/h}$ dose rate limits. However, towards the top at the level of the crane driver cabin, which is located at a height of 7.65 m from the floor, the dose rate slightly exceeds the $15 \mu\text{Sv/h}$ dose rate limit. During beam operation with 160 A GeV/c lead ions a crane exclusion zone above the experiment will therefore need to be put in place.

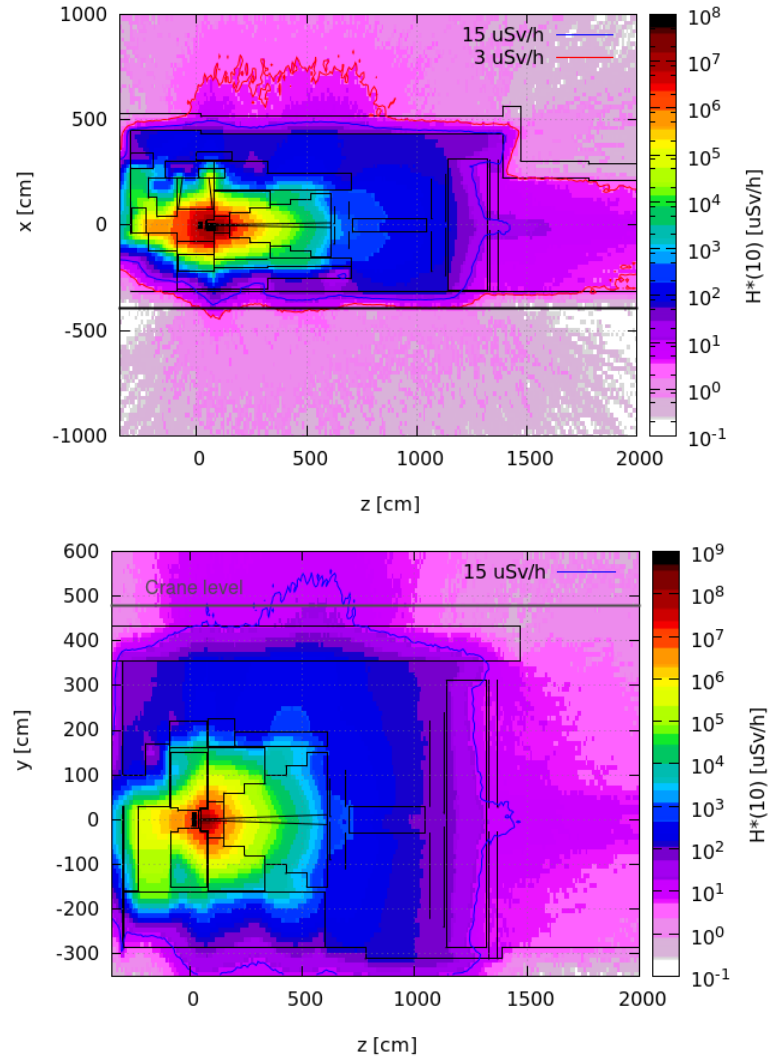

Figure 11: View from above (top) and side (bottom) of the prompt ambient dose equivalent rate in $\mu\text{Sv/h}$ for 1×10^7 Pb ions/spill of 160A GeV/c with 2 spills of 10 s every 40 s. The horizontal cut in the top figure is vertically averaged over ± 50 cm around the beam axis. The vertical cut on the bottom figure is horizontally averaged over ± 40 cm around the beam axis. The red and blue lines illustrate the $3 \mu\text{Sv/h}$ and $15 \mu\text{Sv/h}$ dose rate limits for a Supervised Radiation Area with permanent and low occupancy workplaces, respectively.

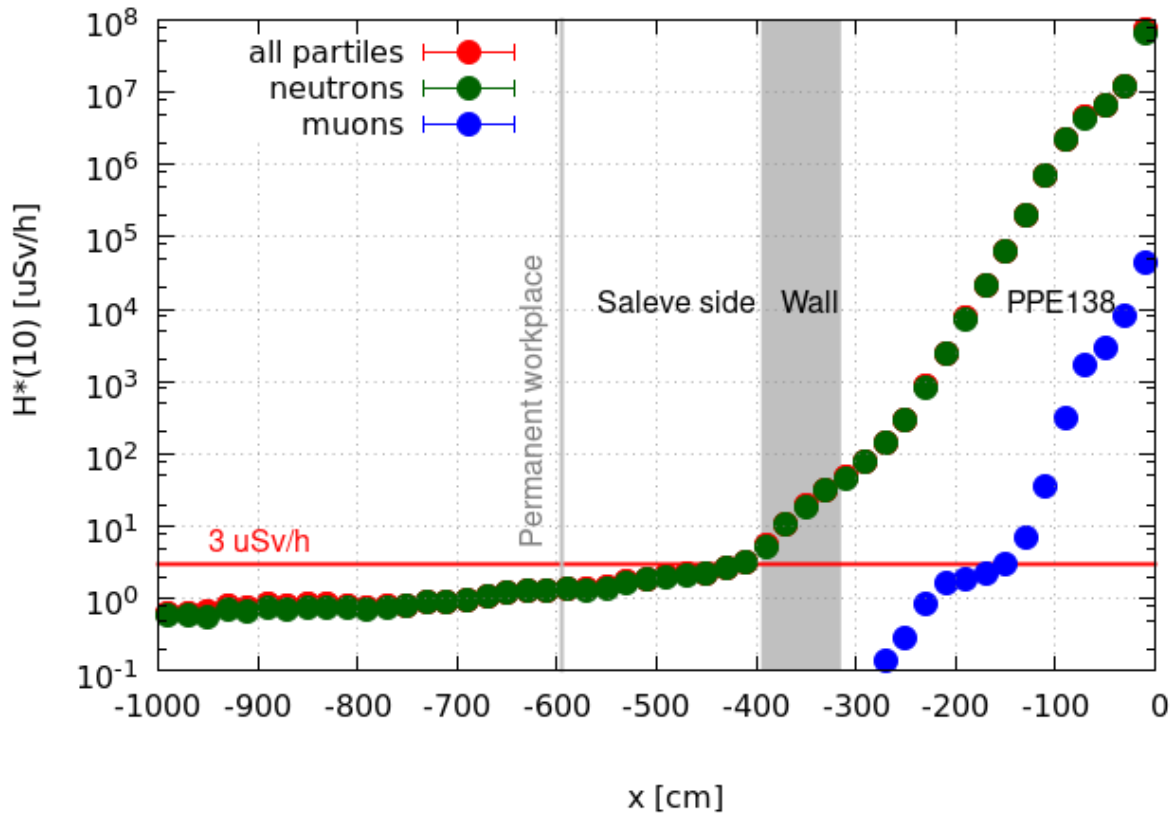

Figure 12: Vertical transverse cut of the prompt ambient dose equivalent rate (in $\mu\text{Sv/h}$) for 1×10^7 Pb ions/spill of 160A GeV/c with 2 spills each 40 s. The values are obtained by averaging vertically over ± 50 cm around the beam axis and longitudinally over 50-100 cm behind the front of the target. The red line illustrates the $3 \mu\text{Sv/h}$ dose rate limits for a Supervised Radiation Area with permanent workplaces.

4.3 Residual Dose Rates

The residual dose rates after 4 weeks of beam operation with 160 A GeV/c lead ions are presented in Figure 13 for different decay times. Also here a safety factor 3 was taken into account. The results show that the area outside of the shielding is compatible with a Supervised Radiation Area even for short decay times. However, close to the target the dose rates largely exceed the given $15 \mu\text{Sv/h}$ limit of a Supervised Radiation Area. Directly upstream of the MEP48 dipole magnet, the dose rates reach approximately $440 \mu\text{Sv/h}$ and $12 \mu\text{Sv/h}$ after 1 minute and 1 week of cooling, respectively. That implies that one week of cooldown should be foreseen before general controlled access to the area is given.

In view of the high residual dose rates in the target area, any access to the chicane leading to the target area is foreseen to be regulated by a specialized procedure. Access will be granted only with the required training for work in such high radiation areas and under supervision by a representative from the CERN Radiation Protection Group (a condition not applicable for the majority of the user zones in EHN1). For shorter cooling times, where the ambient dose rates exceed the limit of a Simple Controlled Radiation Area ($50 \mu\text{Sv/h}$ limit), an operational dosimeter (DMC) is required next to the passive dosimeter (DIS). Furthermore, any work in the highly activated area must be optimized. Next to that, measures to prevent uncontrolled access to the area are to be foreseen.

4.4 Air Activation

To evaluate air activation, the particle fluences were scored in the air regions of experimental zone and then combined with the energy-dependent radionuclide production cross-sections using the ActiWiz Creator tool (Theis & Vincke, Proceedings of the ICRS12 conference, 2012, Nara, Japan. 2013). The dose due to inhalation of activated air was calculated by using the guidance value for airborne activity CA¹ and the inhalation dose coefficients e_{inh} from the Swiss Radiological Protection Ordinance (Swiss Federal Council, 814.501, 2017). The dose was estimated conservatively with 4 weeks of beam operation at maximum intensity and with no air exchange. The intensity per year has been calculated based on the assumptions of 1×10^7 Pb ions/spill of 160A GeV/c with 2 spills each 40 s, 4 weeks (28 days) of operation per year, thus yielding 1.2×10^{12} ions per year on the NA60+ target.

When assuming full mixing between the air regions and no cooling, the specific airborne radioactivity amounts to 0.02 CA and therefore lies below the given limit of 0.1 CA for a Supervised Radiation Area at CERN (D. Forkel-Wirth, EDMS 810149). Here, the largest contribution comes from the short-lived radionuclides ⁴¹Ar, ¹³N, ¹⁵O and ¹¹C. The dose from inhalation during 1 hour of stay was estimated to be of 0.006 μ Sv, with the main contribution coming from ¹⁴C, ³²P, ⁷Be, ³³P and ³⁵S.

¹ Exposure to an airborne activity concentration of 1 CA for 40 hours per week and 50 weeks per year yields a committed effective dose of 20 mSv.

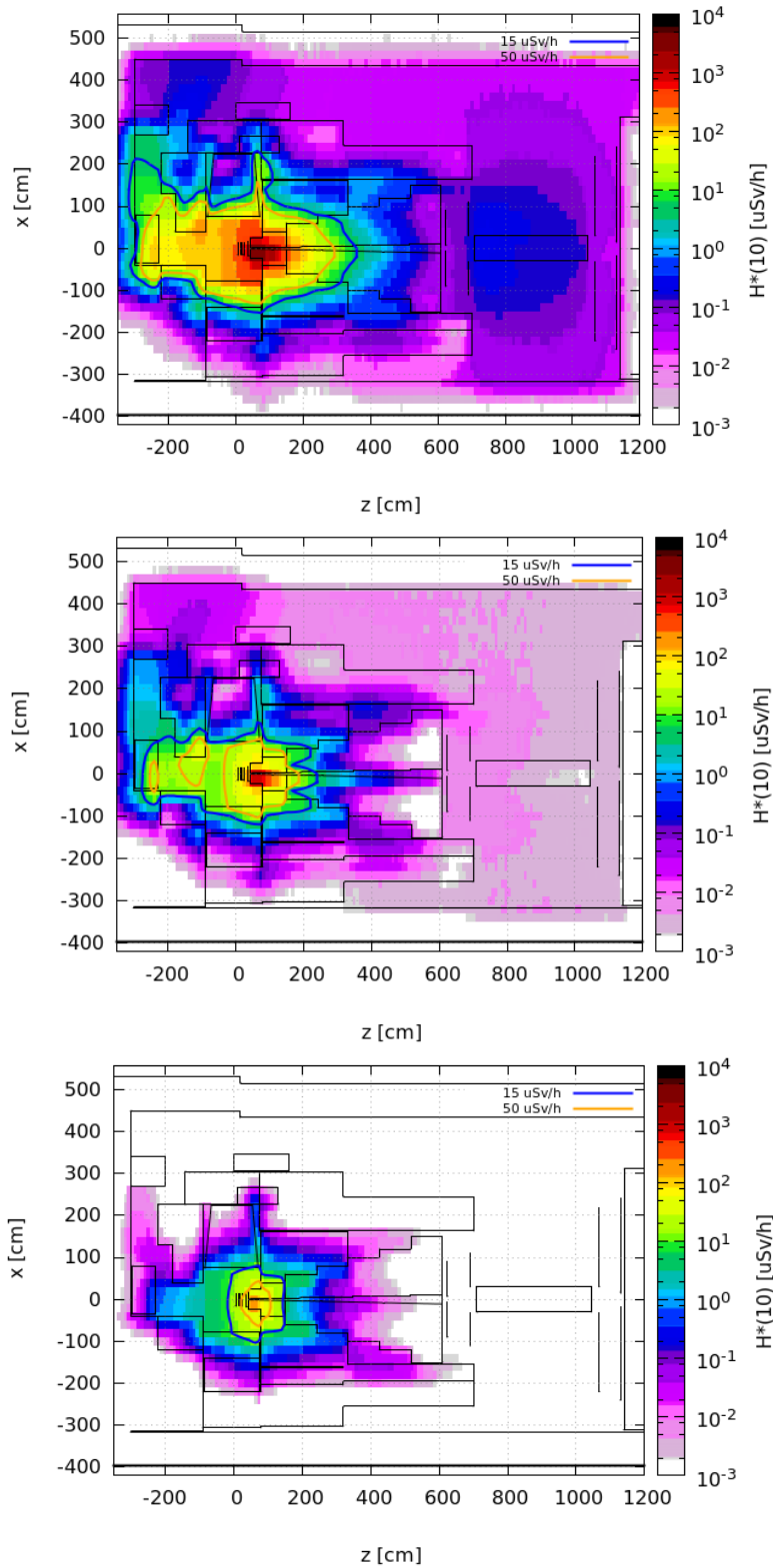

Figure 13: View from above of the residual ambient dose equivalent rate $H^*(10)$ (in $\mu\text{Sv/h}$) for 1 minute (top), 1 day (middle) and 1 week (bottom) of decay after 4 weeks of operation 1.2×10^{12} ions on target. The horizontal cut is vertically averaged over ± 50 cm around the beam axis. The blue and yellow lines illustrate the $15 \mu\text{Sv/h}$ and $50 \mu\text{Sv/h}$ dose rate limits for a Supervised and Simple Controlled Radiation Area, respectively.

4.5 Accidental Beam Loss

Protective measures need to be put in place to mitigate the impact of accidental beam loss upstream of the NA60+ experiment.

The shielding layout of the upstream region is depicted in Figure 14. At several locations only 80 cm of concrete shielding are present and that there are unshielded access doors to the zone.

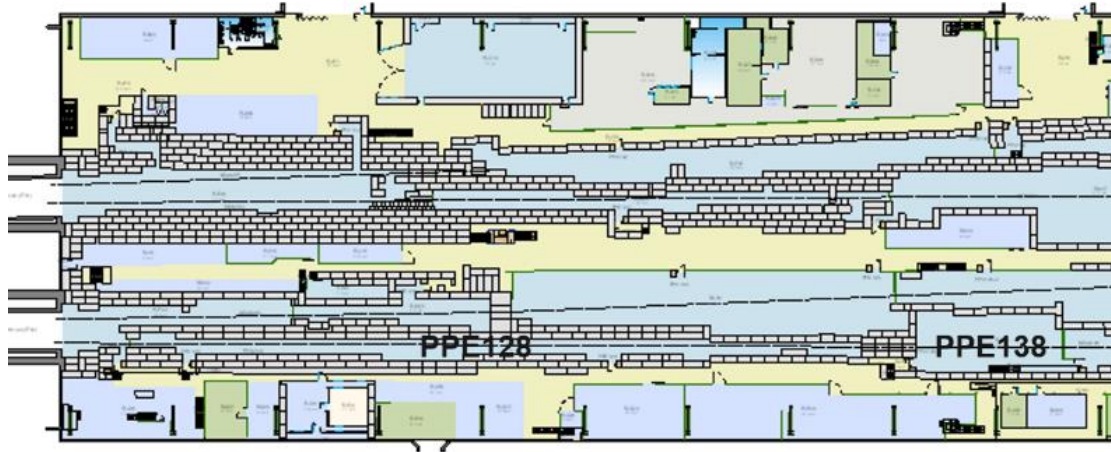

Figure 14: Layout of the shielding of the beamline zone PPE128. The shielding towards the top amounts to 80 cm of concrete.

To study the radiation levels for an accidental beam loss upstream of the experiment, it was assumed that the beam is lost on a massive object, such as a magnet (iron cylinder of $R = 30$ cm, $L = 200$ cm), in a part of the zone where only 80 cm of concrete shielding is present. The results show that the accidental loss of one single spill can cause a dose exceeding $15 \mu\text{Sv}$ (see Figure 15). At least 160 cm of concrete shielding in the upstream region is therefore required. Furthermore, shielding chicanes for the access doors need to be implemented, and a crane exclusion zone has to be established to prevent the crane to travel above the zone during NA60+ beam operation.

While there is an extensive radio protection monitoring system covering the most critical areas of EHN1 (Aberle, EDMS 2211938; Boukabache, et al., Radiation Protection Dosimetry, Volume 173, Issue 1-3, April 2017, Pages 240–244) which raises an alarm in case the radiation levels exceed the set limits, there are currently no dedicated monitors to detect beam losses upstream of the experiment. Additional monitors would therefore need to be installed in this zone.

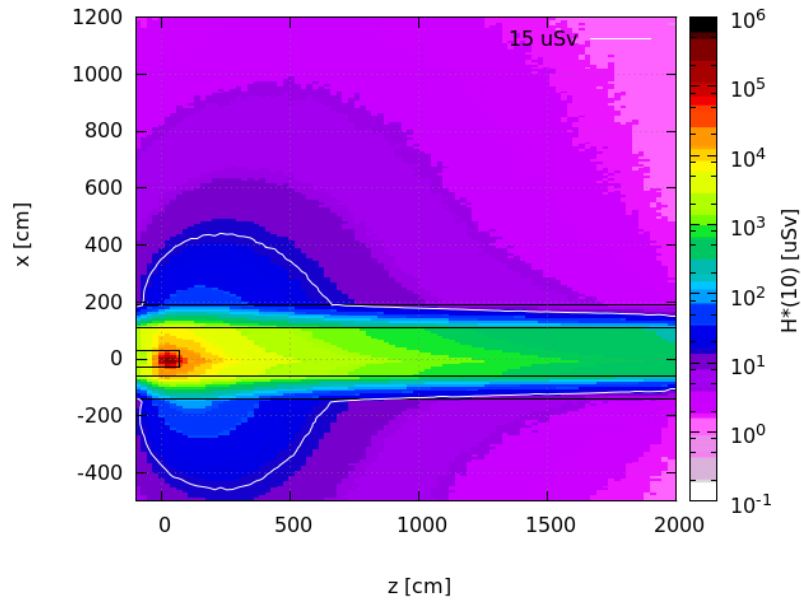

Figure 15: View from above of the prompt ambient dose equivalent $H^*(10)$ (in μSv) for the accidental loss of 1 spill of 1×10^7 lead ions of 160A GeV/c s on a massive object like a magnet (iron cylinder of $R = 30$ cm, $L = 200$ cm) in PPE128. A safety factor 3 was taken into account. The horizontal cut is averaged vertically over ± 100 cm around the beam axis. The white line illustrates 15 μSv , which is the hourly limit for a Supervised Radiation Area with low occupancy.

5 Conclusions: Feasibility Evaluation and Cost Estimation

The potential integration of the NA60+ experiment in the EHN1 surface experimental hall has been examined concerning beam physics requirements, the infrastructure integration and radiation protection. The experiment is deemed to be feasible with regard to these aspects. The detector design, data acquisition, analysis and physics reach will be treated in a Letter of Intent currently in preparation.

A very preliminary cost estimation has been performed for the modifications to the user zone PPE138 described in the present document.

- The volume of additional shielding required for radiation protection reasons has been calculated with FLUKA software to be $2.99 \cdot 10^8$ cm³ for concrete and $3.11 \cdot 10^7$ cm³ for iron. The prices for the shielding blocks have been taken from the orders in the framework of East Area Renovation project. The cost does not include the transportation of the shielding blocks and the installation by the CERN team. Also, in the final design the shielding might need to be moved further from magnet gap in order not to distort the field, which might result in higher overall shielding volume.
- The hall floor excavation of 1.0 m depth and 4.5 m x 6.0 m horizontal dimensions is estimated to cost approximately 100 kCHF.
- Three additional RP monitors are required for the monitoring of the activation levels at critical locations. The monitor acquisition and installation, including cabling and the connection to the RP control systems and interlocks, is estimated to cost 27 kCHF per monitor, and hence 81 kCHF in total for three monitors.

The overall cost of the ground excavation, RP monitors and shielding has been estimated to be approximately 1.4 MCHF. Additional costs (access bridge, cabling, powering of the two magnets, patch panels, shielding transport) have not yet been addressed at this point, but may be significant. These additional costs are not expected to vary strongly between the different potential installation locations for NA60+, while the ground excavation and RP related costs calculated above are location specific (PPE138 of EHN1). It has to be considered that while those estimates give an initial starting point for the order of magnitude of costs, they are far from a precise cost evaluation.

6 Acknowledgement

The authors would like to kindly thank numerous colleagues from NA60+ experiment for the fruitful discussions and their input, as well as Lau Gatignon and Nikolaos Charitonidis for their insights, recommendations and measurement results in regard to ion beams in CERN North Area and the integration aspects.

7 References

- Aberle, F. (EDMS 2211938). *Radiation monitoring layout - SPS North Area*.
- Ahdida et.al., C. (Frontiers in Physics 9, 788253 (2022)). *New Capabilities of the FLUKA Multi-Purpose Code*.
- Ahdida, C., Casolino, M., Avigni, P., Calviani, M., Busom Descarrega, J., Canhoto Espadanal, J., . . . Lamont, M. (CERN-PBC-CONF-2019-001, 2019). *A Beam Dump Facility (BDF) at CERN – The Concept and a First Radiological Assessment*.
- Ahdida, C., Froeschl, R., Iliopoulou, E., Infantino, A., & Jensen, S. (Nuclear Inst. and Methods in Physics Research, A 950 (2020) 162972). *Measurements and FLUKA simulations of aluminium, bismuth and indium activation by stray radiation from the annihilation of low energy antiprotons*.
- Banerjee, D., Bernhard, J., Brugger, M., Charitonidis, N., Doble, N., Gatignon, L., & Gerbershagen, A. (02 Jul 2021). *The North Experimental Area at the Cern Super Proton Synchrotron*.
<https://cds.cern.ch/record/2774716?ln=en>: CERN Document Server, CERN-ACC-NOTE-2021-0015.
- Battistoni, G., Boehlen, T., Cerutti, F., Chin, P., Esposito, L., Fassò, A., . . . Smirnov, G. (Annals of Nuclear Energy 82, 10-18 (2015)). *Overview of the FLUKA code*.
- Bohlen, T. T., Cerutti, F., Chin, M. P., Fassò, A., Ferrari, A., Ortega, P. G., . . . Vlachoudis, V. (Pages Nuclear Data Sheets 120, 211–214, 2014). *The FLUKA Code: Developments and Challenges for High Energy and Medical Applications*.
- Boukabache, H., Pangallo, M., Ducos, G., Cardines, N., Bellotta, A., Toner, C., . . . Forkel-Wirth, D. (Radiation Protection Dosimetry, Volume 173, Issue 1-3, April 2017, Pages 240–244). *Towards a novel modular architecture for CERN radiation monitoring*.
- C. Ahdida, F. Aberle. (EDMS 2125733). *Radiation protection assessment of the NA61 Pb ion run in 2018*.
- D. Forkel-Wirth. (EDMS 810149). *Zonage radiologique au CERN*.
- D.Banerjee, J.Bernhard, M.Brugger, N.Charitonidis, G.L.d’Alessandro, N.Doble, . . . M.Rosenthal. (2018). *Report from the Conventional Beams Working Group to the Physics beyond Collider Study and to the European Strategy for Particle Physics*. *CERN-PBC-REPORT-2018-002*(CERN Document Server, <https://cds.cern.ch/record/2650989>).
- Dahms, T., Scomparin, E., & Usai, G. (2019). *Expression of Interest for a new experiment at the CERN SPS: NA60+*. CERN-SPSC-2019-017 ; SPSC-EOI-019: CERN Document Server, <https://cds.cern.ch/record/2673280?ln=en>.
- Gazdzicki (NA61/SHINE), M. (CERN-SPSC-2019-041, SPSC-SR-261, 2019). *Report from the NA61/SHINE experiment at the CERN SPS*.
<https://fluka.cern>. (n.d.).
- Iliopoulou, E., Bamidis, P., Brugger, M., Froeschl, R., Infantino, A., Kajimoto, T., . . . Siountas, A. (Nucl. Instrum. Methods Phys. Res. A, 885 (2018), pp. 79-85). *Measurements and FLUKA simulations of bismuth and aluminium activation at the CERN Shielding Benchmark Facility (CSBF)*.
- Iliopoulou et.al., E. (J. Phys.: Conf. Ser., 1046 (2018), Article 012004). *Measurements and FLUKA simulations of bismuth, aluminium and indium activation at the CERN Shielding Benchmark Facility (CSBF)*.
- Jaeckel, J., Lamont, M., & Vallée, C. (2020). *The quest for new physics with the Physics Beyond Colliders programme*. *Nat. Phys.*, 16(<https://doi.org/10.1038/s41567-020-0838-4>), 393–401.

- Nakao.et.al., N. (Nucl. Instrum. Methods Phys. Res. B, 266 (2008), pp. 93-106). *Measurement and calculation of high-energy neutron spectra behind shielding at the CERF 120 GeV/c hadron beam facility.*
- Swiss Federal Council. (814.501, 2017). *Radiological Protection Ordinance.*
- Theis, C., & Vincke, H. (Proceedings of the ICRS12 conference, 2012, Nara, Japan. 2013). *ActiWiz - Optimizing your Nuclide Inventory at Proton Accelerators with a Computer Code.*
- Vlachoudis, V. (Proc. Int. Conf. on Mathematics, Computational Methods & Reactor Physics (M&C 2009), Saratoga Springs, New York, 2009). *FLAIR: A Powerful But User Friendly Graphical Interface For FLUKA.*