



# LHCb status report

Claire Prouve  
on behalf of the LHCb Collaboration

149<sup>th</sup> LHCC meeting – open session

09/03/2022



IGFAE

Instituto Galego de Física de Altas Enerxías

USC

UNIVERSIDADE  
DE SANTIAGO  
DE COMPOSTELA



XUNTA  
DE GALICIA

# LHCb Upgrade I

New software trigger based detector for Run 3:

- 40MHz readout
- All electronics replaced in all subsystems
- Pile-up of 6 (used to be  $\sim 1.5$ )

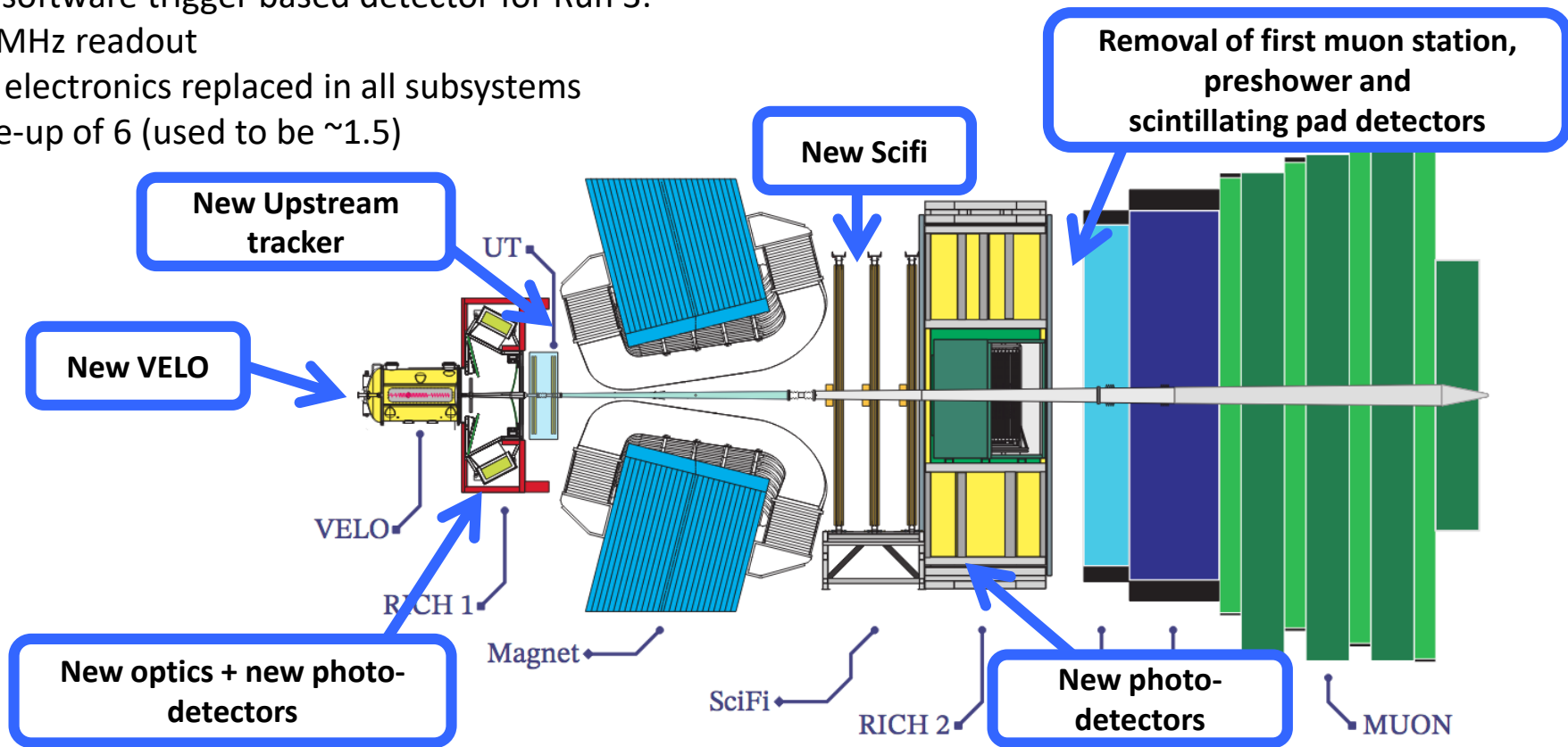

# VELO

- Side C safely arrived at CERN end of January: no connection or bond wire lost in transport
- Detailed inspection, testing and fixing of last issues performed at CERN
- Installation of side C performed March 1-2
  - Commissioning launched:  
scans, calibrations, clustering, tracking, closure
- Assembly of side A being completed
- Shipping for side A scheduled for April

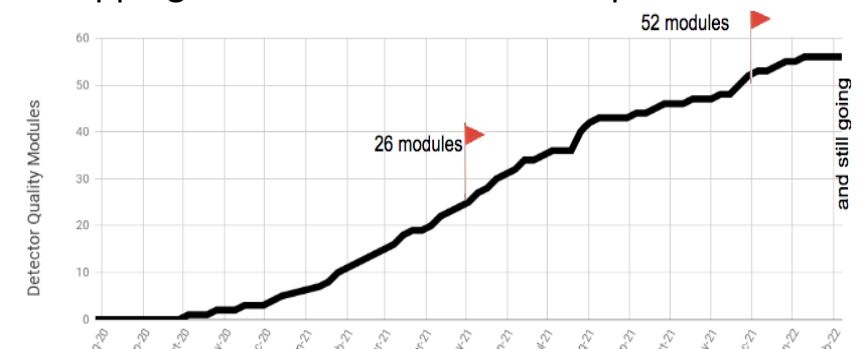



# RICHs

## RICH 1

- Last MaPMT column installed end of January
- Verification of connections with test patterns
- Installation of magnetic shielding this week
- Ensure RICH 1 is light tight and installation of light leak detector
- Switching on the High Voltage

## RICH 2

- Installation complete last year
- Took data during beam test in October
- Gas leak discovered 2 weeks ago: fixed last weekend

*Ready in time for cavern closure*

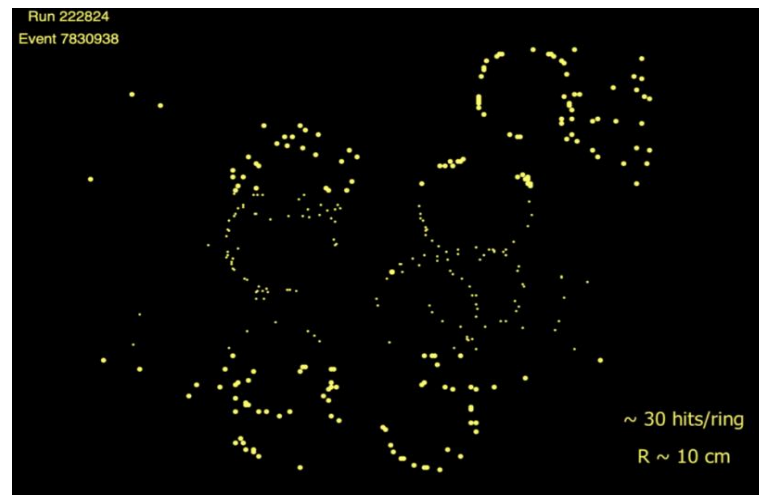
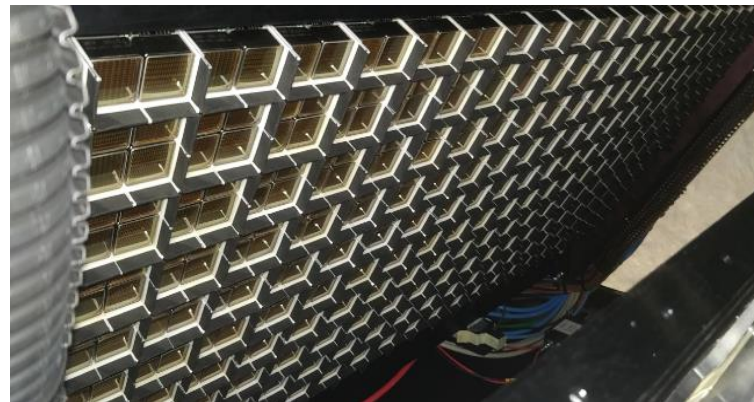
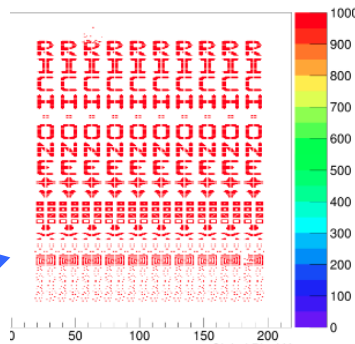

# UT

Decision taken in December not to install before cavern closure:

- Complete Service and Mechanics before cavern closure
- Requested installation of first side in September
- Installation of second side during YETS

Status:

- All staves produced
- Most staves arrived at CERN
- Assembly started on the surface, first stave in UT installed
- Test installation of empty UT side last week



# SciFi

- Installation of frames finished end of February
- Connection of last frames finished last week
- Commissioning and debugging of cable and fibre connections on-going
- Installation of few remaining Front End boxes on-going
- Alignment and closure of frames on-going:
  - Initial movement and position studies will be done over the next two to three days
  - Put the central modules within 0.2mm from their nominal design positions
  - Final closing very carefully while beam-pipe under vacuum

*Ready in time for cavern closure*

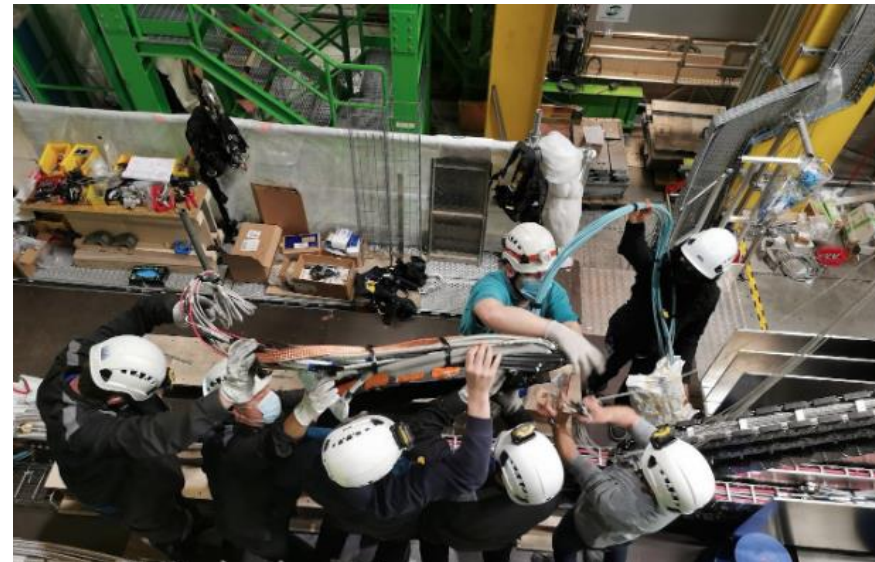
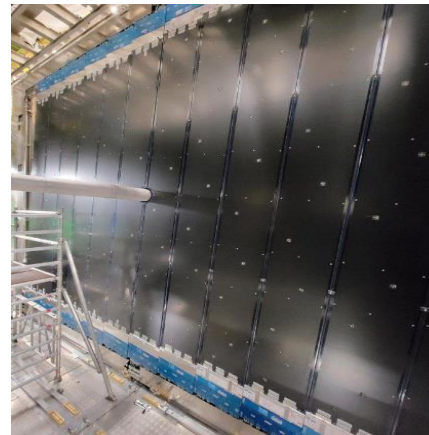



# CALO

- Calibration and monitoring systems are operational
- Upgrade of CALO moving system is installed and commissioned
- New Front End Electronics and new High Voltage are installed and in commissioning
- Update of firmware of Front End board planned to add more functionalities (counters, usage of the commands...)
- Testing the quality of the 8000 connections between the photomultipliers and the Front End boards on-going

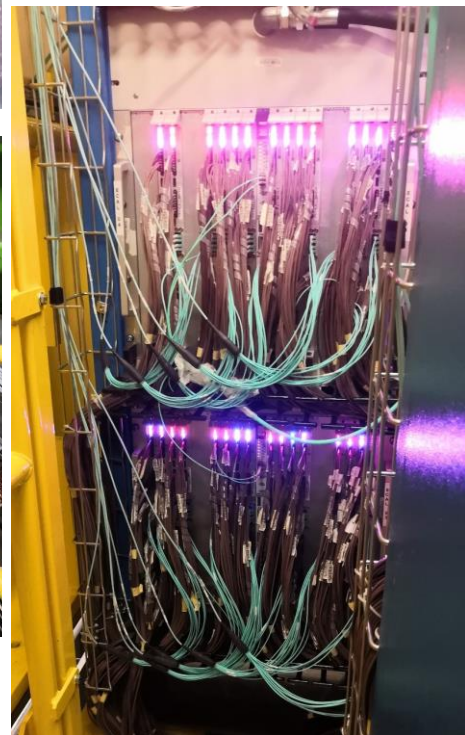

*Ready in time for cavern closure*

# Muon

- Chambers and very Front End: all ok; working on residual ~100 problematic channels out of 100k
- Low Voltage, High Voltage, Gas, Temperature: ready and tested during beam test in October
- Front End electronics (ECS and DAQ): all new boards tested and ready
- Monitoring: rewritten from scratch

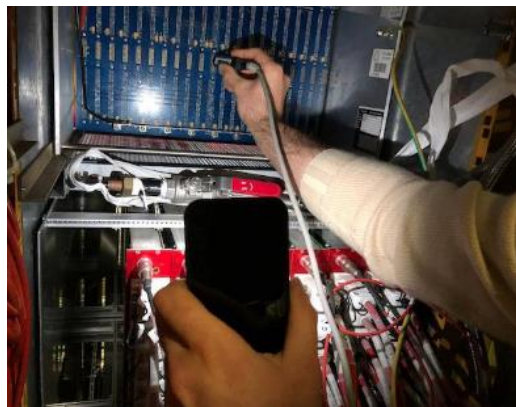
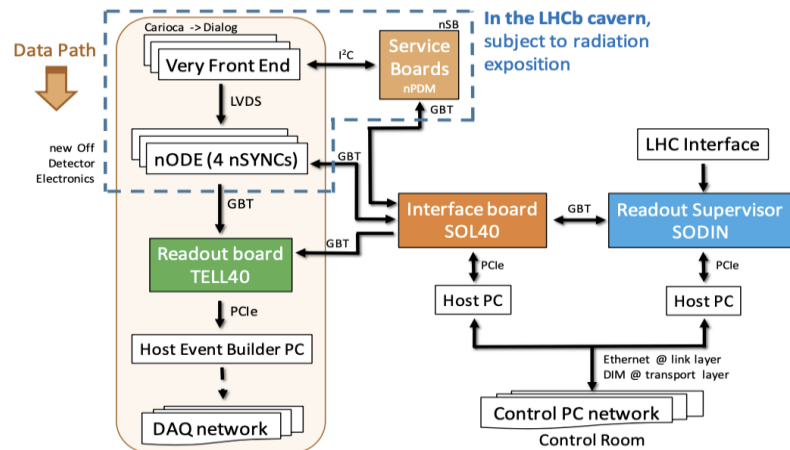

**Muon firmware and software being updated to Run 3 detector and environment.**

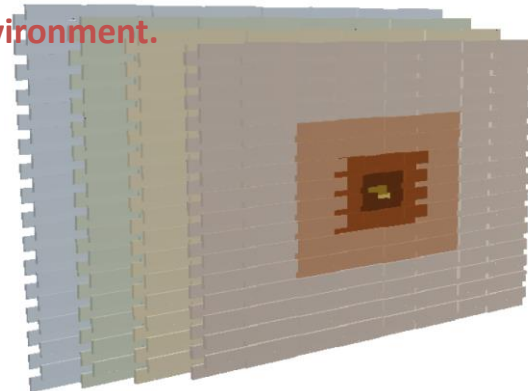

*Ready in time for cavern closure*



# Computing and Online

## Computing

- Reprocessing of Run2 data finished last year
- Computing work dominated by MC production (93%)
- Simulating about 260 million events per day
- 2023 resources request under review

## Online

- Most of the GPUs for HLT1 installed
- Disks and servers for HLT1 buffer arrived and installed
- Disks and servers for HLT2 buffer arrived last week
- Preparing for data taking:
  - Exercising data transfer from P8 to EOS and Tier1 sites
  - Tape challenges in preparation

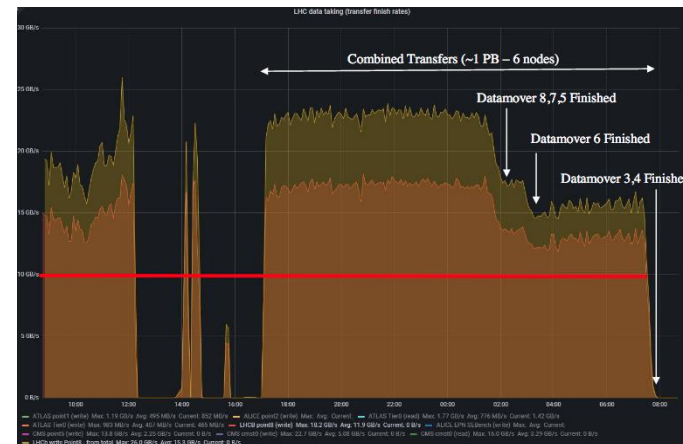
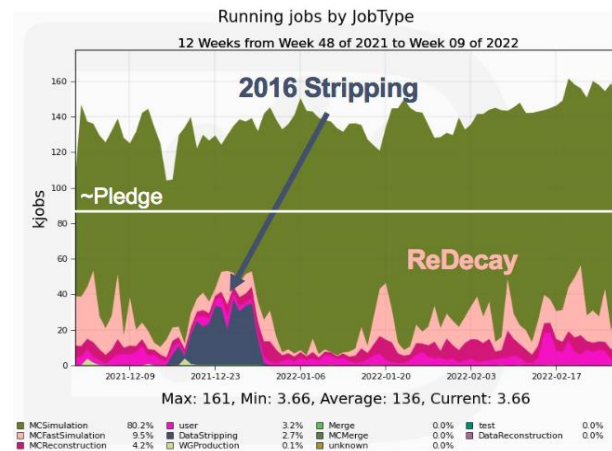

# Commissioning

- October test beam good preparation for cosmics
  - First integration sessions in December
  - Included RICH2, MUON, ECAL, HCAL in LHCb partition
  - Exercise the full system and study any issues
- Sub-detectors are now regularly working in their own partition → Using central timing distribution, readout firmware, Event Builder and online infrastructure
- Significant Global Commissioning only after cavern closure
  - RICH1+RICH2+MUON+CALO commissioning advanced
  - Advanced commissioning of online systems with particular attention to online infrastructure, clock, timing and controls
  - Trackers will need to finalize commissioning with beam, benefit from accesses and periods with no beam
- Full Experiment System Test (FEST) weeks
  - Run simulated data through the whole online and offline chain
  - 4 weeks to date, 2 since November, next end of March

Mon 14-Feb-2022 15:37:05  
root

Device: tfcAllocator State: READY

Partition Configuration

Partition	PartitionID	Name	RunInfo Name	State	
01	0x0	0	Free	None	DEALLOCATED
02	0x1800	6144	CALO	CAECS:CALO_RunInfo	READY
03	0x0200	512	RICH2	RIECS:RICH2_RunInfo	NOT_READY
04	0x0010	16	RICH1	RIECS:RICH1_RunInfo	READY
05	0x0400	1024	PLUME	PLECS:PLUME_RunInfo	READY
06	0x0008	8	VELOC	VEECS:VELOC_RunInfo	READY
07	0x0100	256	SFC	SFECS:SFC_RunInfo	READY
08	0x8000	32768	TDET	TDECS:TDET_RunInfo	ACTIVE
09	0x0000	24576	MUON	MUECS:MUON_RunInfo	NOT_READY
10	0x0	0	Free	None	DEALLOCATED

Expert Allocator  
Manual Allocation Reserve Partitions  
fwVersions Panel

Subsystem Configuration

Subsystem	Partition
01 TFC	
02 Free	
03 VELO A	
04 VELO C	Part_06
05 RICH1	Part_04
06 UT A	
07 UT C	
08 SCIFI A	
09 SCIFI C	Part_07
10 RICH2	Part_03
11 PLUME	Part_05
12 ECAL	Part_02
13 HCAL	Part_02
14 MUON A	Part_09
15 MUON C	Part_08
16 TDET	Part_08

Messages

Exit Close

Allocator panel showing the sub-systems allocated to individual partitions!  
→ Almost full house!

# Real Time Analysis (Trigger)



- HLT1 reconstruction and selections are in good shape
- HLT2 reconstruction is in good shape and selections are actively being worked on ( 852 HLT2 lines to date, 562 of which fully use the new framework)
- Alignment and calibration work is in good shape
- Commissioning and integration work is on-going, beam test data and FEST weeks very helpful
- HLT1 tracking w/o UT studies: improved tracking efficiencies for slightly higher ghost rates  
→ some lines might need retuning

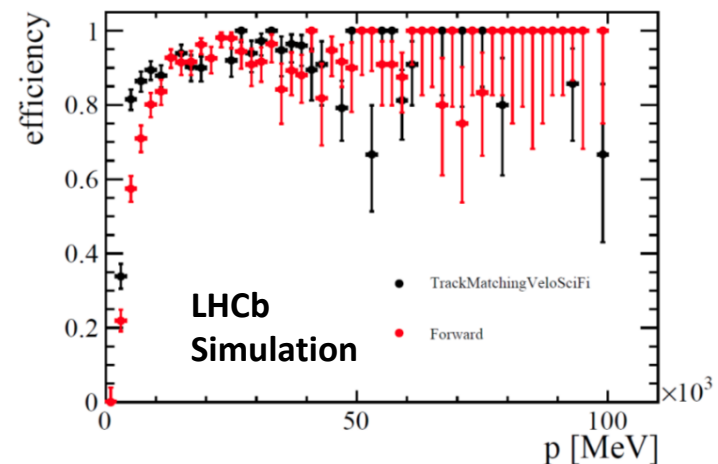

	HLT1 tracking w/o UT		Conventional HLT1 tracking	
	Bs -> $\phi\phi$	Min Bias	Bs -> $\phi\phi$	Min Bias
HI1TrackMVA	21 %	3.8 %	21 %	1.8 %
Hlt1TwoTrackMVA	32 %	2.1 %	31 %	1.5 %



# LHCb Upgrade II

CERN-LHCC-2021-012



Fully realise the flavour physics potential of the HL-LHC

- Installation during LS4 of the LHC
- Peak luminosity  $\sim 1.5 \times 10^{34} \text{cm}^{-2} \text{s}^{-1}$  (pile-up  $\sim 40$ )
- Integrate  $300 \text{fb}^{-1}$  through the lifetime of the HL-LHC
- Replacement of all existing spectrometer components to increase the granularity, reduce the amount of material in the detector and to exploit the use of new technologies

Framework TDR released:

- physics motivation, sub detector design, environmental impact, schedule + cost
- LHCC recommendation session today

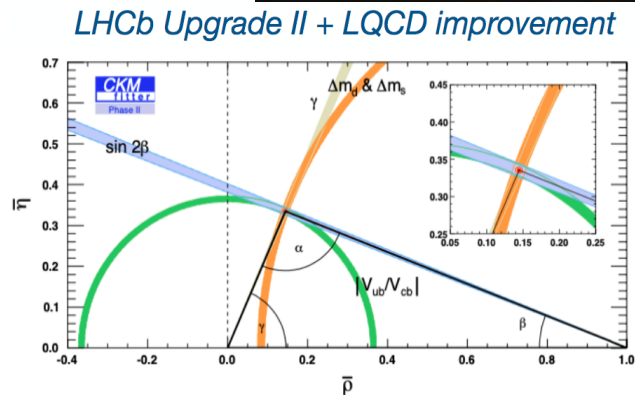
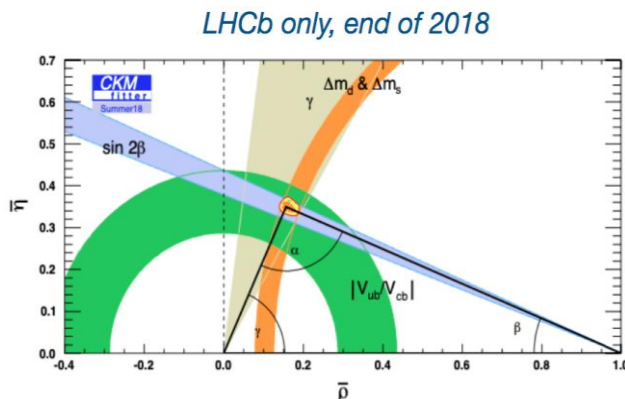

# Physics results

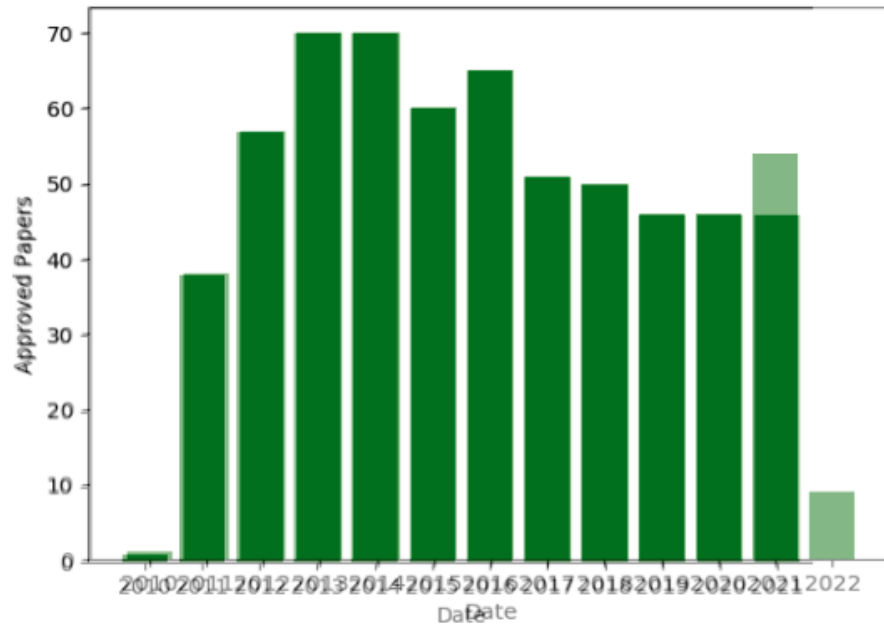
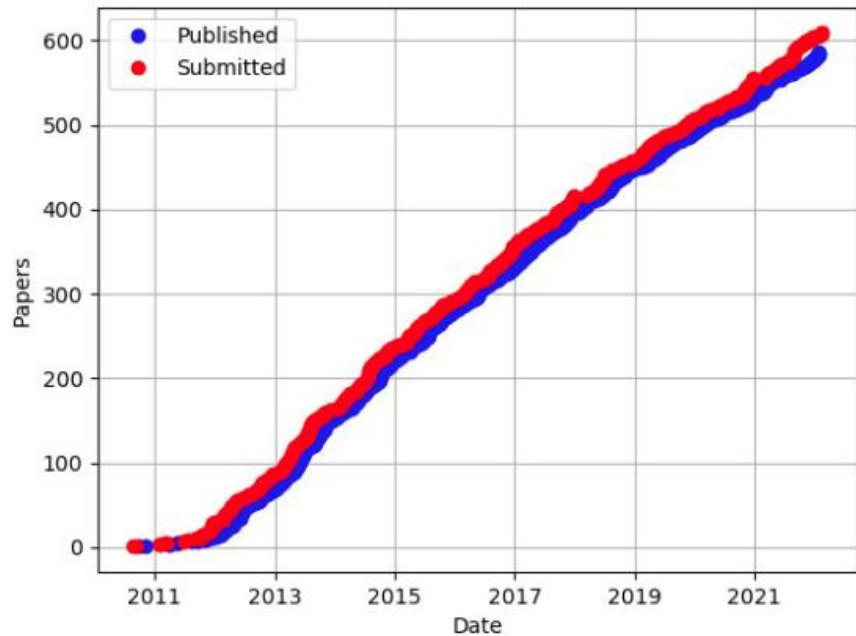

## Papers submitted since last LHCC:

- [PAPER-2021-052] Observation of the doubly charmed baryon decay  $\Xi_{cc}^{++} \rightarrow \Xi_c^+ \pi^+$
- [PAPER-2021-044] Observation of the decay  $\Lambda_b^0 \rightarrow \Lambda_c^+ \tau^- \nu_\tau$
- [PAPER-2021-041] Measurement of the charm mixing parameter  $y_{CP} - y_{CP}^{K\pi}$  using two-body  $D^0$  meson decays
- [PAPER-2021-047] Study of charmonium and charmonium-like contributions in  $B^+ \rightarrow J/\psi \eta K^+$  decays
- [PAPER-2021-042] Search for the decay  $B^0 \rightarrow \phi \mu^+ \mu^-$
- [PAPER-2021-043] Observation of the  $B^0 \rightarrow D^{*0} K^+ \pi^-$  and  $B_s^0 \rightarrow D^{*0} K^- \pi^+$  decays
- [PAPER-2021-036] Constraints on the CKM angle  $\gamma$  from  $B^\pm \rightarrow D h^\pm$  decays using  $D \rightarrow h^\pm h'^\mp \pi^0$  final states
- [PAPER-2021-037] Precision measurement of forward Z boson production in proton-proton collisions at  $\sqrt{s}=13$  TeV
- [PAPER-2021-040] Observation of  $\Lambda_b^0 \rightarrow D^+ p \pi^- \pi^-$  and  $\Lambda_b^0 \rightarrow D^{*+} p \pi^- \pi^-$  decays
- [PAPER-2021-039] Searches for rare  $B_s^0$  and  $B^0$  decays into four muons
- [PAPER-2021-030] Measurement of the photon polarization in  $\Lambda_b^0 \rightarrow \Lambda \gamma$  decays
- [PAPER-2021-048] First measurement of  $Z \rightarrow \mu^+ \mu^-$  angular coefficients in the forward region of  $pp$  collisions at  $\sqrt{s}=13$  TeV

## **Preliminary since last LHCC:**

- [PAPER-2021-045] Observation of  $\omega$  contribution in the  $X(3872) \rightarrow \pi^+ \pi^- J/\psi$  decays

*Many new results for the Moriond conferences!*



# Observation of the decay $\Lambda_b^0 \rightarrow \Lambda_c^+ \tau^- \bar{\nu}_\tau$ (1/2)

- Hints of Lepton Flavour Universality violation in the meson sector  $R(D)$  and  $R(D^*)$

$$R_{D^*} = \frac{\mathcal{B}(B \rightarrow D^{(*)} \tau \nu)}{\mathcal{B}(B \rightarrow D^{(*)} \mu \nu)}$$

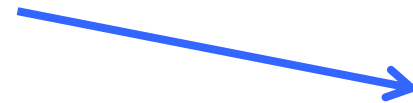

- $R(\Lambda_c^+)$  can be below or well above SM, when satisfying  $R(D^*)$ - $R(D)$  constraints

$$\mathcal{R}(\Lambda_c^+) \equiv \frac{\mathcal{B}(\Lambda_b^0 \rightarrow \Lambda_c^+ \tau^- \bar{\nu}_\tau)}{\mathcal{B}(\Lambda_b^0 \rightarrow \Lambda_c^+ \mu^- \bar{\nu}_\mu)}$$

- Complementary constraints with baryonic decay
  - Spin 1/2 spectator
  - Different NP couplings
- Unique to LHCb

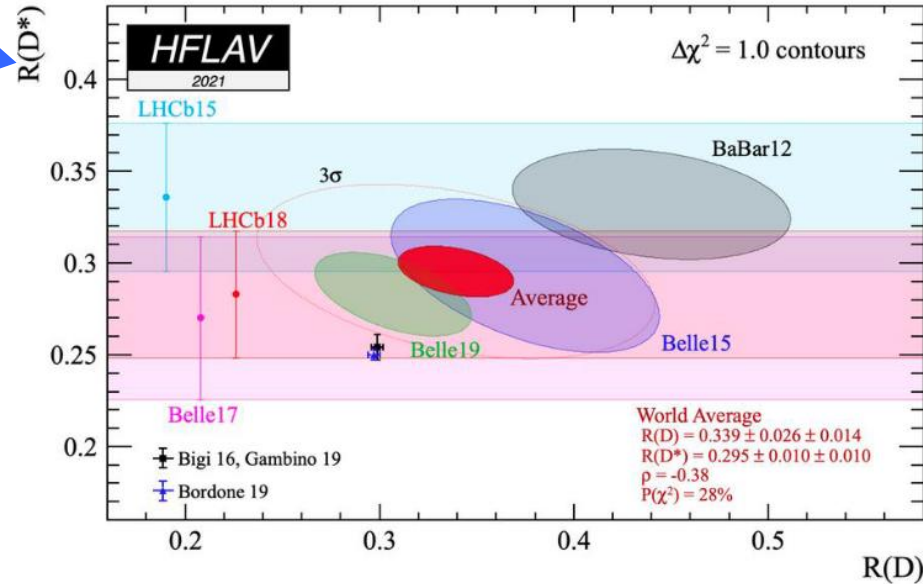

# Observation of the decay $\Lambda_b^0 \rightarrow \Lambda_c^+ \tau^- \nu_\tau$ (2/2)

- Reconstruct  $\tau^- \rightarrow \pi^- \pi^+ \pi^- (\pi^0) \nu_\tau$
- Simultaneous 3D fit to  $\tau$ ,  $q^2$ , BDT
- **First observation of  $\Lambda_b^0 \rightarrow \Lambda_c^+ \tau^- \nu_\tau$  with  $6\sigma$  significance**
- $B(\Lambda_b^0 \rightarrow \Lambda_c^+ \tau^- \nu_\tau) = (1.50 \pm 0.16 \pm 0.25 \pm 0.23)\%$
- $\mathcal{R}(\Lambda_c^+) \equiv \frac{B(\Lambda_b^0 \rightarrow \Lambda_c^+ \tau^- \bar{\nu}_\tau)}{B(\Lambda_b^0 \rightarrow \Lambda_c^+ \mu^- \bar{\nu}_\mu)} = 0.242 \pm 0.026 \pm 0.040 \pm 0.059$   
in agreement with SM prediction of  $0.324 \pm 0.004$
- **Provides constraints on NP models, such as those for which large values of  $R(\Lambda_c^+)$  are allowed by existing  $R(D^{(*)})$  measurements**

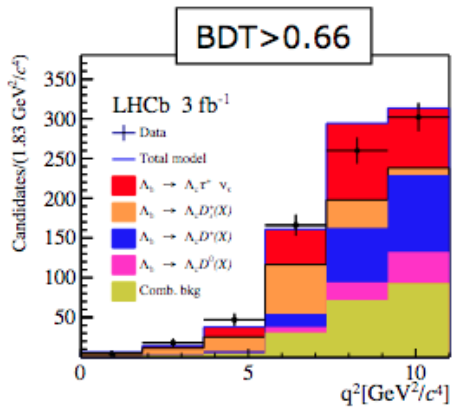
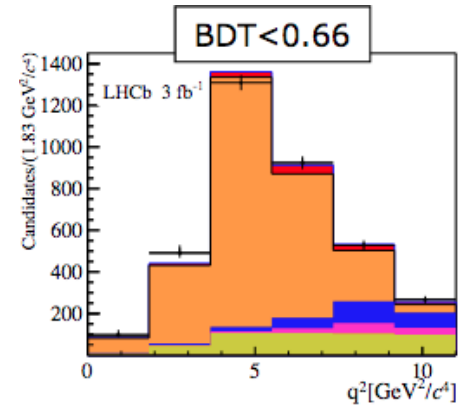
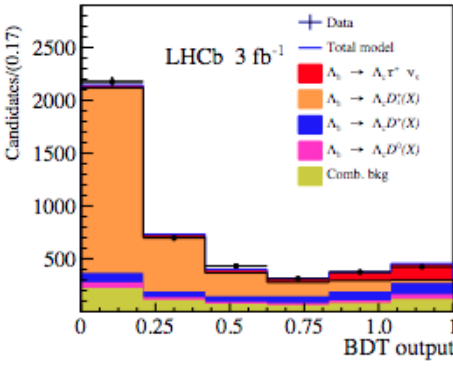
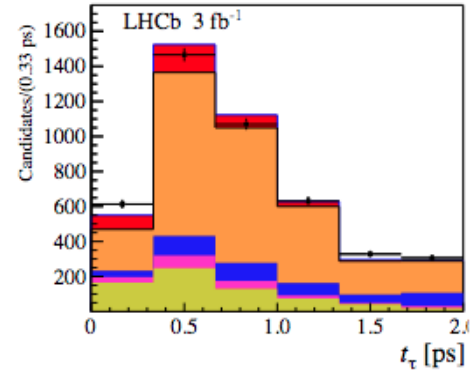

# Measurement of the charm mixing parameter $y_{CP} - y_{CP}^{K\pi}$ using two-body $D^0$ meson decays (1/2)

$D^0$  mixing due to mass eigenstates  $\neq$  flavour eigenstates

$$Prob(D^0 \rightarrow \bar{D}^0, t) = \left| \frac{q}{p} \right|^2 \frac{e^{-\Gamma t}}{2} (\cosh(y\Gamma t) - \cos(x\Gamma t))$$

$$x = \frac{m_1 - m_2}{\Gamma}$$

$$y = \frac{\Gamma_1 - \Gamma_2}{2\Gamma}$$

$y$  is small ( $\sim 10^{-3}$ ) and difficult to predict, experimental determination of  $y$  is important to improve charm sector predictions

$$y_{CP}^f - y_{CP}^{K\pi} \approx y(1 + \sqrt{R_D})$$

$$R^{KK}(t) = \frac{dN(D^0 \rightarrow K^- K^+, t)}{dN(D^0 \rightarrow K^- \pi^+, t)} \propto e^{-(y_{CP}^{KK} - y_{CP}^{K\pi})t/\tau_{D^0}}$$

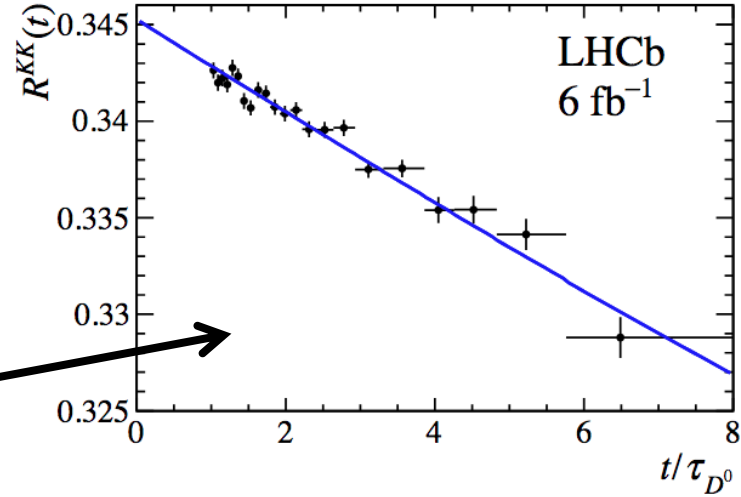



# Measurement of the charm mixing parameter $y_{CP} - y_{CP}^{K\pi}$ using two-body $D^0$ meson decays (2/2)

- $D^0 \rightarrow K\pi^+$  as normalization channel: first analysis so precise it has to account for mixing via doubly Cabibbo suppressed  $D^0 \rightarrow K^+\pi^-$  decays

- Compatible with world average and **more precise by a factor of 4**

$$y_{CP} - y_{CP}^{K\pi} = (6.96 \pm 0.26 \pm 0.13) \times 10^{-3}$$

- LHCb combination: **improve sensitivity on  $y$  by factor of 2**

$$y = (6.46 \pm_{-0.25}^{+0.24}) \times 10^{-3}$$

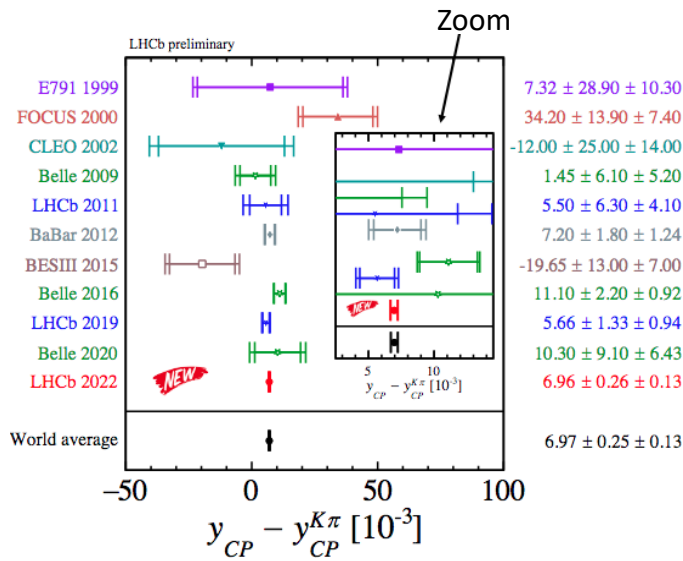
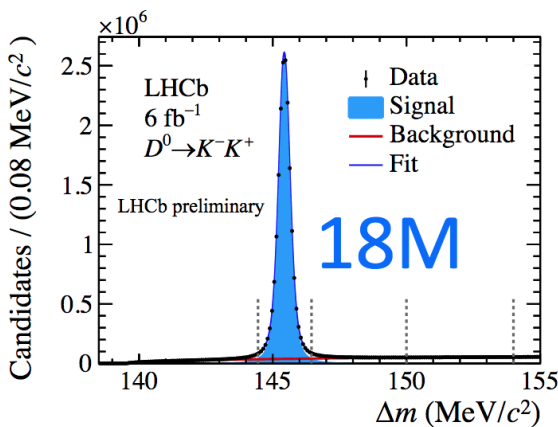
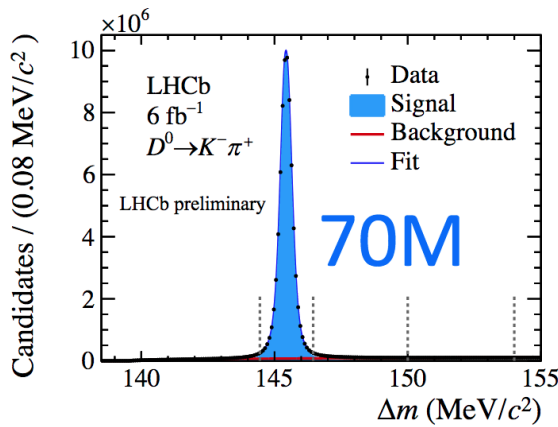

# Observation of the doubly charmed baryon decay $\Xi_{cc}^{++} \rightarrow \Xi_c'^+ \pi^+$

- This measurement can be used to test various theoretical models
  - Internal structure: (cu)c vs (cc)u
  - Internal and external W-emission in decay
  - Flavour wave-function symmetry
- $\Xi_{cc}^{++} \rightarrow \Xi_c'^+ (\rightarrow \Xi_c^+ \gamma) \pi^+$  with photon not reconstructed
- **3<sup>rd</sup> observed decay mode of  $\Xi_{cc}^{++}$**
- The result is not consistent with current theoretical predictions, and will provide input for future calculations

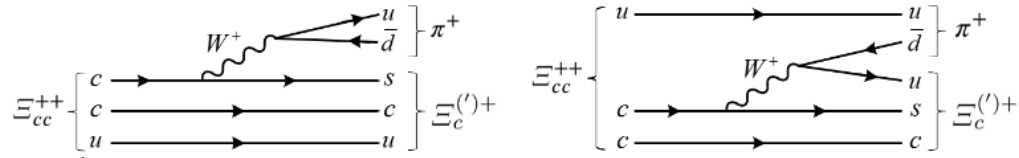

$$\frac{\mathcal{B}(\Xi_{cc}^{++} \rightarrow \Xi_c'^+ \pi^+)}{\mathcal{B}(\Xi_{cc}^{++} \rightarrow \Xi_c^+ \pi^+)} = 1.41 \pm 0.17 \pm 0.10$$

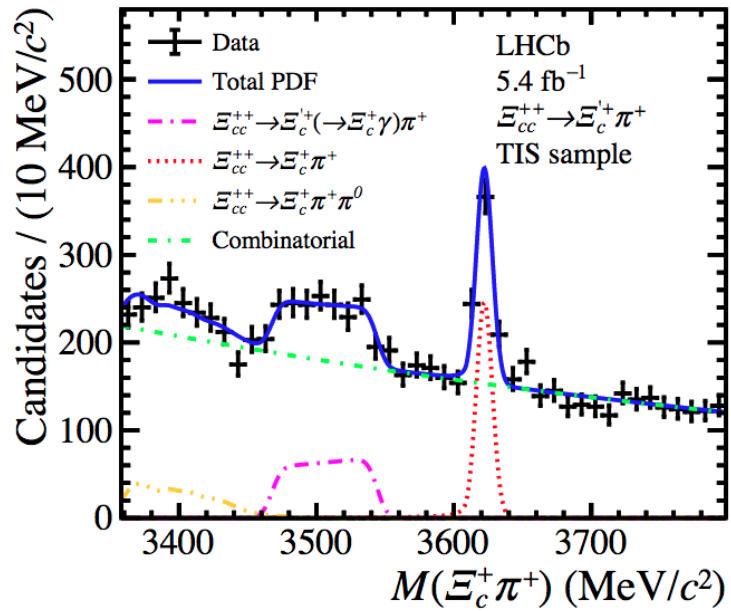

# Discovery of sizeable $\omega$ contribution to $\chi_{c1}(3872) \rightarrow \pi^+\pi^-J/\psi$ decays

Internal structure of  $\chi_{c1}(3872)$  unknown  
 → isospin can give insight

- $\chi_{c1}(3872) \rightarrow \rho^0 J/\psi$  isospin violating
- $\chi_{c1}(3872) \rightarrow \omega J/\psi$  isospin conserving

First analysis to take into account  $\rho^0$ - $\omega$  interference:

- $\omega$  contribution w/o interference:  $(1.9 \pm 0.4 \pm 0.3) \%$  consistent with previous measurements
- **$\omega$  contribution w/ interference:  $(21.4 \pm 2.3 \pm 2.0)\%$**
- Isospin violating component  $\rho^0$  properly quantified for the first time  
 → too large by an order of magnitude for  $\chi_{c1}(3872)$  to be a pure charmonium state

Charmonium ?

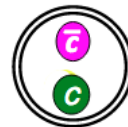

$D^0\bar{D}^{*0}$  molecule ?

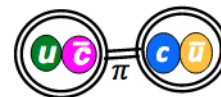

Diquark tetraquark ?

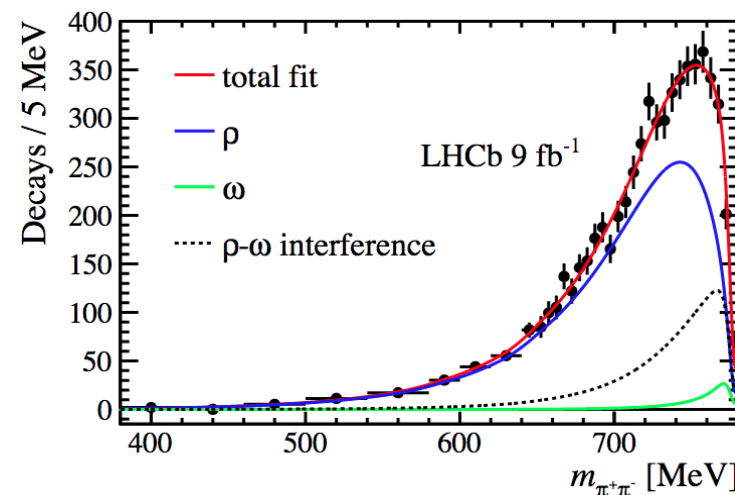

# Study of charmonium and charmonium-like contributions in $B^+ \rightarrow J/\psi \eta K^+$ decays

- Full spectroscopy of  $J/\psi \eta$  mass spectrum
- Search for 12 known charmonium and charmonium-like states:  
2 observations + 10 branching ratio limits

$$\mathcal{B}(B^+ \rightarrow \psi_2(3823)(\rightarrow J/\psi \eta)K^+) = (1.25^{+0.71}_{-0.53} \pm 0.04) \times 10^{-6}$$

$$\mathcal{B}(B^+ \rightarrow \psi(4040)(\rightarrow J/\psi \eta)K^+) = (8.53 \pm 2.35 \pm 0.30) \times 10^{-6}$$

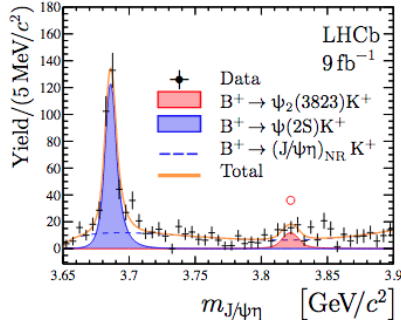
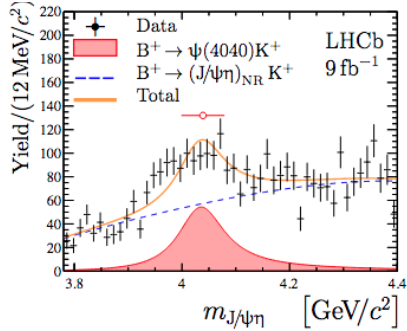

- R(3760)
- $\psi(3770)$
- $\psi_3(3842)$
- $\psi(4160)$
- $\psi(4415)$
- R(3790)
- $Z_c(3900)^0$
- $\psi(4230)$
- $\psi(4360)$
- $\psi(4390)$

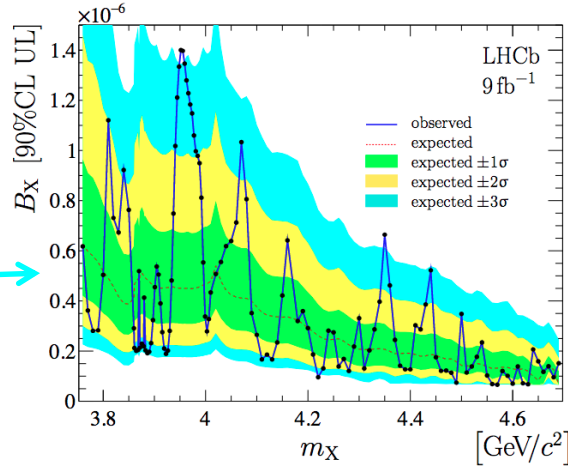

- Some models for  $\chi_{c1}(3872)$  predict a partner state  $X'_c \rightarrow$  search for states in  $J/\psi \eta$  mass spectrum  
 $\mathcal{B}(B^+ \rightarrow X'_C(\rightarrow J/\psi \eta)K^+) < 3.9 \times 10^{-7}$  (90% CL) Improvement on previous limits by an order of magnitude

# Summary

## Wide physics programme:

- World's most precise charm mixing measurements
- Lepton flavour universality tests in baryonic sector, semi-leptonic decay with  $\tau$
- Exotics and spectroscopy

For the months ahead we are looking forward to the challenge of commissioning the entire readout and trigger, and soon, the completion of the VELO installation and the UT.

