

EE

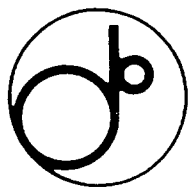

KEK Preprint 94-130
October 1994
A

High-Precision Spot Size Monitors for e^+e^- Linear Colliders

T. SHINTAKE

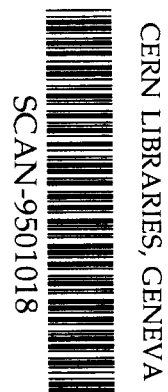

5W9502

*Invited talk at the 17th International Linac Conference (LINAC94),
Tsukuba, Japan, August 21 - 26, 1994.*

National Laboratory for High Energy Physics, 1994

KEK Reports are available from:

Technical Information & Library
National Laboratory for High Energy Physics
1-1 Oho, Tsukuba-shi
Ibaraki-ken, 305
JAPAN

Phone: 0298-64-1171
Telex: 3652-534 (Domestic)
(0)3652-534 (International)
Fax: 0298-64-4604
Cable: KEK OHO
E-mail: LIBRARY@JPNKEKVX (Bitnet Address)
library@kekvax.kek.jp (Internet Address)

High-Precision Spot Size Monitors for e^+e^- Linear Colliders

T. Shintake

KEK: National Laboratory for High Energy Physics
1-1 Oho, Tsukuba-shi, Ibaraki 305 Japan

Abstract

In the future e^+e^- linear colliders, the electron and positron beams must be focused into a very small flat-beam at the interaction point. Several methods to measure such small spot-size have been proposed, and some of them have been already tested in FFTB at SLAC. This article summarizes such trial of nanometer spot-size measurement.

Introduction

In the future e^+e^- linear colliders[1,2], the spot-size at the interaction point must be focused down to a few nanometer in vertical and a few hundred nanometer in horizontal flat beam in order to get high luminosity. To do this, intensive R&D works are running about the subjects : generating low emittance beam in damping ring, acceleration in main linac and focusing in the final focus system.

In order to study technical problems to generate such small spot, the prototype final focus test facility: FFTB (Final Focus Test Beam) was constructed at SLAC. In this facility, the low emittance electron beam from the damping ring is focused into spot-size of 1 micron in horizontal and 60 nm in vertical. To measure this spot-size, several new methods have been proposed, and two monitors were actually developed and tested during the dedicated beam run-time of April to May in this year. They exhibited very good performance on nanometer beam measurements and demonstrated ability to provide enough information for beam tuning procedure. At the end of this beam run-time, using the new monitor it was proven that 70 nm beam was generated at the focus point.

In this article, not only the new methods but also conventional technique to measure the spot-size will be reviewed, and the technical problem of these method in applying nanometer spot measurement will be discussed.

Wire Scanner

Measurement mechanism of the wire scanner is straightforward. By scanning charged particle beam across a thin wire or moving a wire across a beam, while measuring bremsstrahlung gamma-ray flux or a current flow into the wire due to the secondary electron emission, we can get one-dimensional beam profile

informations. Using two or three wires in appropriately oriented combination, we know the beam profile in two-dimensions. This type of monitor has been very widely used to measure beam profile or its position in high energy accelerators for long time. Concerning to measure a spot-size at micron-meter range, the wire scanner was firstly used at the collision point in SLC[3,4,5]. Where thin carbon fibers with nominal diameters of 30, 7 and 4.5 μm were used, and the beam profiles of 3 to 50 μm wide-range dimension were measured. It was a big challenge to install the monitor inside the Mark II detector at the collision point. This monitor has been used long time and demonstrated ability to tune the beam at micrometer dimensions.

In the FFTB experiment, in order to measure a flat beam a specially arranged wire[6] was used as shown in Fig. 1. The horizontal wire measure the vertical size of the beam, and slightly tilted wires resolve the skew components and horizontal beam size. This monitor was very useful to tune the skew-knob in the intermediated focal point before the final telescope, where the spot-size is 210 μm in horizontal and 1.1 μm in vertical, very flat beam[7].

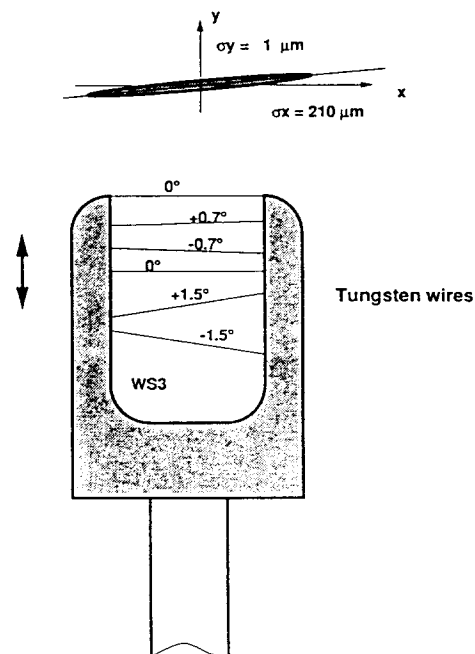

Fig.1. Specially arranged wire scanner for a very flat beam of intermediate focal point in FFTB[6].

However, it will not be able to apply the wire scanner to nanometer spot dimensions, since the carbon fibers will be easily destroyed by thermo-mechanical stress induced by beam hitting energy. Fig. 2 shows such experience in FFTB test. When we scanned the beam near the focal point, a 4 μm carbon fiber was destroyed due to the beam of 0.7×10^{10} electrons per pulse.

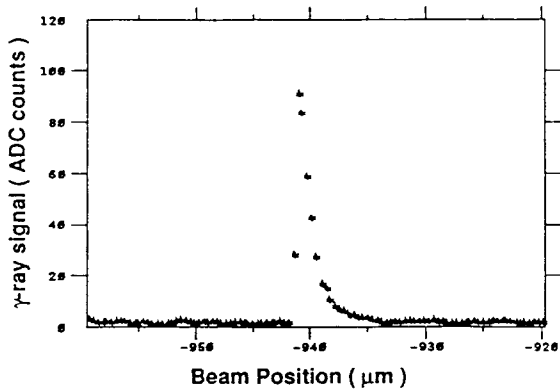

Fig. 2. Wire break due to beam experienced in FFTB.

Bunch-by-bunch Measurement using Wire Scanner

In the future linear collider, the beam must be operated in multibunch mode. Therefore it will be quite important to develop techniques to measure bunch-by-bunch properties in multibunch beam. Recently, H. Hayano et al[8] successfully measured the bunch-by-bunch emittance in the ATF beam line at KEK. The multibunch beam of 2.8 nsec time spacing provided by the ATF injector was scanned across a wire, and the gamma-ray signal of individual bunch was measured via gated photo-multiplier R5916U, which is recently developed in Hamamatsu Photonics K.K. The measured beam emittance is shown in Fig. 3.

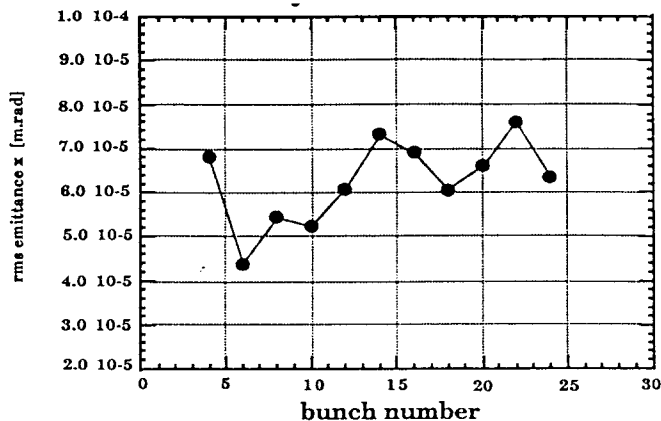

Fig. 3. Measured bunch-by-bunch emittance of multibunch electron beam using a gated photo-multiplier and a wire-scanner[8].

In order to overcome the difficulty encountered in using the wire scanner to spot-size measurement of sub-microm size or smaller, several new ideas have been proposed. Among them, the gas ionization monitor and a monitor using the laser-interferometry were developed and already tested in the FFTB.

Gas Ionization Beam-Size Monitor

This monitor makes use of the fact that the space charge field inside a bunch is inversely proportional to the beam dimensions[9]. A light ions such as He^+ oscillates during the beam passing inside the potential well of the bunch. In case of a flat beam, the oscillation amplitude is higher in horizontal than in vertical, as a results, after the bunch passing more ions are emitted in horizontal than in vertical direction. By measuring this asymmetry in the azimuthal distribution of ion flux, the aspect ratio $R = \sigma_x/\sigma_y$ can be determined. In case of heavy gas atom, such as Ar^+ , which does not move much during the bunch passing. Their maximum velocity is then inversely proportional to the horizontal dimension of the beam. The measurement of the minimum time of flight of Ar^+ ions gives the horizontal dimensions of the beam.

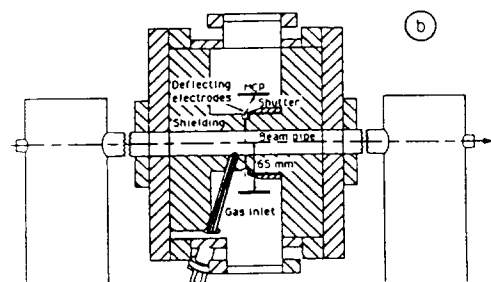
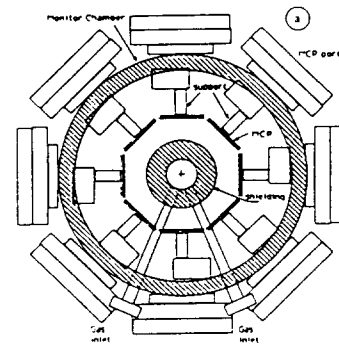

Fig. 4 Schematic view of gas-ionization beam-size monitor[11].

In order to test this method in experimentally, the monitor was developed as shown in Fig. 4 and installed in FFTB focal point. By means of eight multichannel-plates and eighty strip-electrodes, the azimuthal distribution of ion can be analyzed. In the dedicated beam test in April to May 1994, this monitor was firstly

tested and performed very well as predicted by theory. Fig. 5(a) shows an example measured data. The azimuthal dependence took peaks in horizontal direction as expected, and from the ratio of the peak to the bottom the aspect-ratio of the electron beam was determined. Fig. 5(b) is the time-of-flight spectrum obtained with Argon gas. The waist scan using this monitor showed very good fitting to a parabola as shown in Fig. 6, and it demonstrated the wide sensitive-range of this monitor. The minimum measured spot-size using this monitor was in the range of 100 to 200 nm in vertical and 2 μm in horizontal.

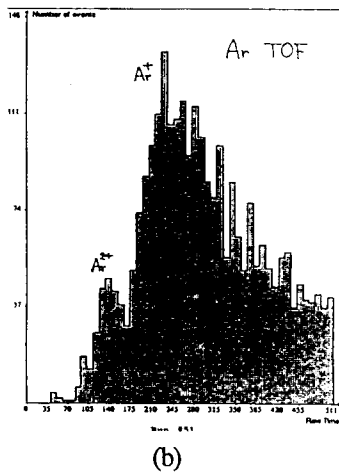
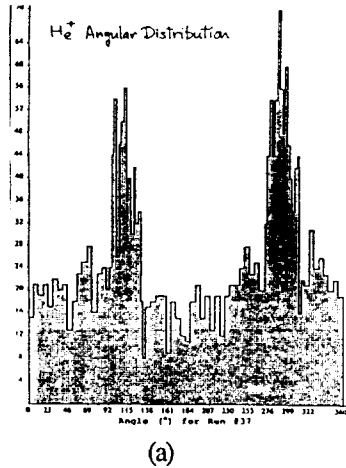

Fig. 5 Measured ion data in FFTB test[12]. (a) Azimuthal distribution of He^+ ions. (b) Time of flight spectrum obtained with Argon gas.

During the beam test, it was found that this monitor was quite sensitive to the shape of the beam tail ("banana-effect"). Using a linac bump to create a tail, sensitivity was tested, and the monitor exhibited a good linear response on this quantity. This feature is quite useful to tune the beam trajectory along the linac to minimize the tail of the bunch.

In case of the future linear collider, the beam transverse dimension is too small, and the maximum space charge field in the bunch exceeds the threshold of direct

ionization of gas. Consequently, the gas will be directly ionized by field emission, i.e., "tunneling ionization", and ionized ghost will be created around the beam. It makes the spot-size measurement quite difficult.

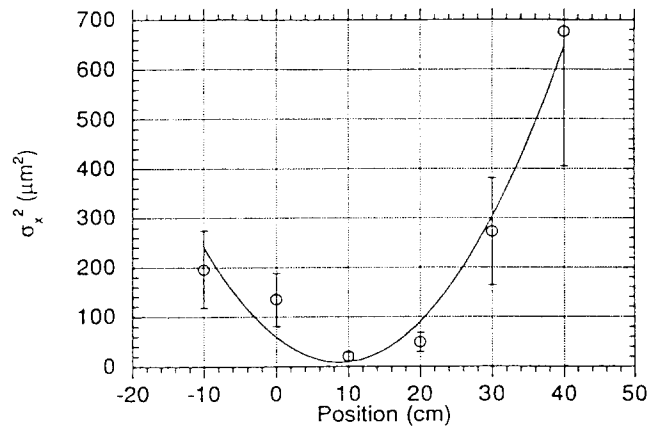

Fig. 6 Waist scan: Correlation between the distance to the waist and the measured dimension[12].

Laser-Interferometry

A laser beam is not subject to be broken by intense electron-beam hitting. Therefore if we use a laser beam as a wire there is no limitation due to the very high space-charge field accompanied by the beam. However, a question is how to measure the nanometer spot using a laser beam, whose wavelength is much bigger than the spot-size.

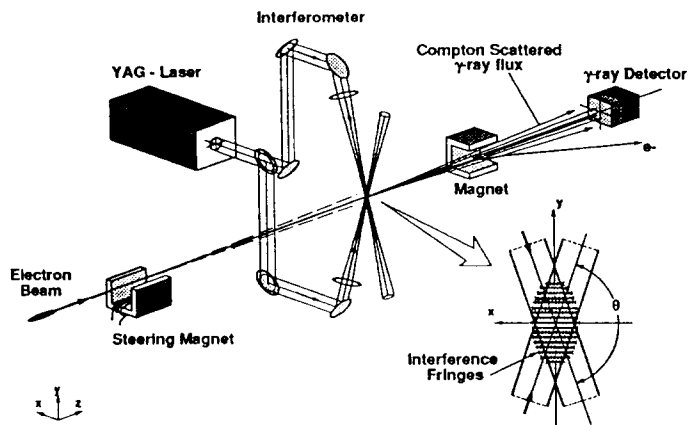

Fig. 7 Schematic drawing of the nanometer spot-size monitor using laser-interferometry.

An idea was devised by the author[13] which utilizes the laser-interferometry. This method is explained in Fig. 7 schematically. The laser-light emitted from a YAG-laser splits in two beams, focusing and overlapping again at the common focal point of the

electron beam, and create interference fringes. The electron beam is scanned across this fringe pattern to yield a modulated rate of Compton-scattered gamma-ray according to the bright and dark zones of the fringes. For a large beam, the effects of the fringe are averaged and the gamma ray flux becomes almost constant. In contrast, for a small spot, the gamma ray flux shows large amplitude periodic modulation. Therefore, measuring the modulation amplitude, we can determine the spot-size of perpendicular direction to the fringe. The actual monitor system can create three different fringe patterns of different fringe pitch by changing crossing angle of laser beams[14]. The monitor covers sensitive spot-size range from 700 down to 40 nm in vertical, and from 3 down to 0.7 μm in horizontal. In the FFTB test, this monitor was used to precisely tune the vernier knobs to minimize residual dispersion, coupling of the beam and trim sextupoles. An example of the measurement is shown in Fig. 8. The modulation depth in this example is 0.68. By correcting an error due to spread of the laser-spot on the small beta-function beam, the spot-size was determined as 66 nm[15]. Repeated measurements taken at the focal point over a period of several hours were 70 nm mean and standard deviation 6 nm[7].

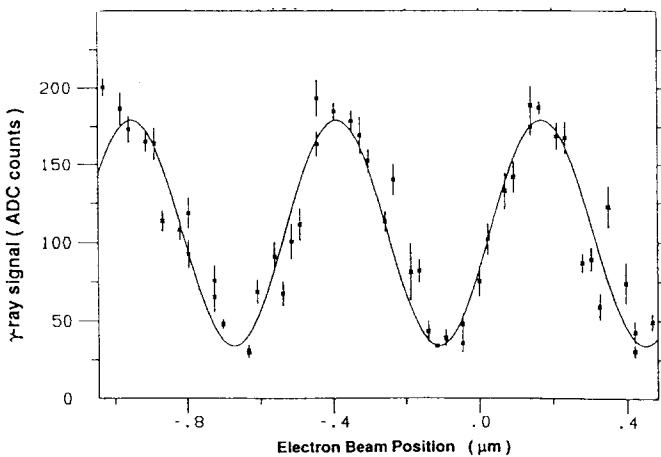

Fig. 8 An example of measured modulation in gamma-ray data. The fringe spacing agrees well with the 0.5 μm expected from the wavelength of the laser. The spot-size is determined by the modulation depth.

This monitor is quite reliable, because

(a) The fringe spacing is directly determined by the laser wavelength and crossing angle of laser beams. The laser wavelength is well defined and crossing angle is determined only by the geometrical parameters. We do not need additional calibration.

(b) Due to the interference effect, the fringe contrast is quite insensitive to various errors, such as, misalignment of laser beams, laser power imbalance, fluctuation of laser beam position.

In case of the future linear colliders, using shorter wavelength laser, such as 5th harmonic of YAG-laser at 213 nm, it will be able to measure the minimum spot-size about 4 nm.

$e^+ e^-$ Pair Monitor

Recently, T. Tauchi proposed a new method to monitor the nanometer spot-size during beam-beam collision at the interaction point[16]. The mechanism of this monitor is similar to the gas ionization monitor, but the e^\pm pairs provide the information instead of the ion in this case. As shown in Fig. 9, the electron and positron pairs are created in intense high energy beam during collision, and their momentum are deflected by Lorentz force due to the space charge field of incoming-beam. Fig. 10 shows an example result of simulation using ABEL-code in case of JLC collision point. The maximum angle of deflection gives the spot-size σ_x in major axis. And the angular distribution gives an information of the aspect ratio. In Fig. 10, the spot is very flat, $\sigma_x = 260 \text{ nm}$, $\sigma_y = 3.4 \text{ nm}$, the angular distribution has a very narrow and deep vary in horizontal direction. Tauchi pointed out a fact that the ratio of population in horizontal axis to the vertical axis is almost linearly proportional to the beam aspect ratio. This monitor is also sensitive to the vertical displacement, and transverse rotation of beam. Therefore, this monitor will be quite useful for real-time feedback of the beam steering and the spot-size control during the beam collision.

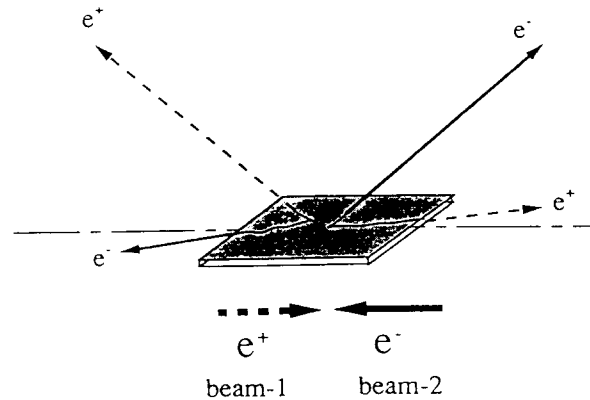

Fig. 9. Spot size monitor using pairs created in beam-beam interaction.

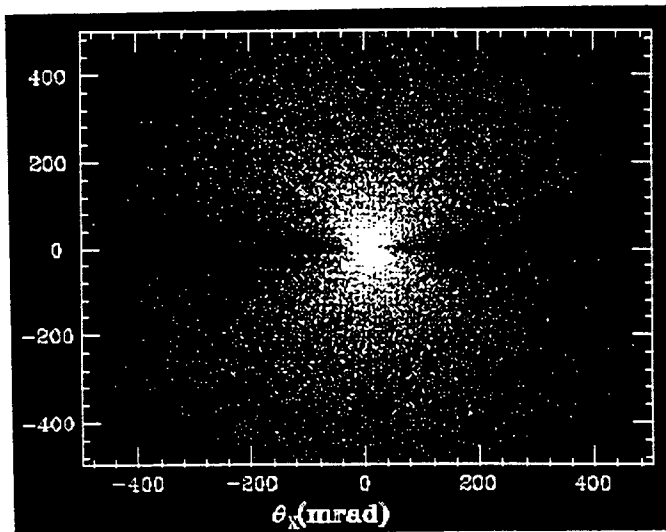

Fig. 10. Distribution of deflected electrons for JLC. Simulation by ABEL for the spot-size of $\sigma_x = 260$ nm, $\sigma_y = 3.4$ nm.

Summery

With the advance of R&D works to develop beam-monitoring technology requested to e^+e^- linear colliders, new ideas to measure the transverse spot-size in nanometer range were found. Some of them have been already tested using several tens nanometer spot at FFTB SLAC, and they demonstrated usefulness for tuning of final focus system. Because of this success, we may believe the nanometer beam observation technique is close to our hand.

References

- [1] Proceedings of Fifth Int. Workshop on Next-Generation Linear Colliders, LC93, Oct 13-21, 1993, SLAC-436, CONF-9310257, UC-414 (M)
- [2] G. A. Loew, "Review of Studies on Conventional Linear Colliders in the S- and X-band Regime", proceedings of XVth Int. Conf. on High Energy Accelerators, HEAC'92, Hamburg Germany, July 20-24, 1992, pp. 777-783
- [3] R. Fulton et al., "A High Resolution Wire Scanner for Micron-Size Profile Measurements at the SLC", Nucl. Instrum. and Meth. A274 (1989) 37-44

- [4] G. Brown et al., "Retractable Carbon Fiber Targets for Measuring Beam Profiles at the SLC Collision Point", Nucl. Instrum. and Meth. A278 (1989) 664-669
- [5] C. Field et al., "A compact beam profile probe using carbon fibers", Nucl. Instrum. and Meth. A295 (1990) 279-282
- [6] C. Field, "Wire Scanners", proceedings of Final Focus Test Beam Collaboration Meeting, October 11-12, 1993
- [7] D. L. Burke, The Final Focus Test Beam Collaboration, "Results from the Final Focus Test Beam", European Particle Accelerator Conference, EPAC 94, London, UK, 1994
- [8] H. Hayano et al, July 1994, private communication.
- [9] J. Buon, "Possibility to measure very small spot sizes using gas ionization at future linear colliders", LAL/RT 89-05, August 1989.
- [10] J. Buon et al., "A Beam Size Monitor for the Final Focus Test Beam", LAL/RT 90-14, December 1990
- [11] J. Buon et al., "The ORSAY Spot Size Monitor for the Final Focus Test Beam", proceedings of XVth Int. Conf. on High Energy Accelerators, Hamburg, Germany July 20-21 (1992) pp. 219-221
- [12] P. Puzo, "First Results of the Orsay Beam Size Monitor for the Final Focus Test Beam", contributed to European Accelerator Conference, EPAC 94, London, UK, 1994
- [13] T. Shintake, "Proporsal of a nanometer beam size monitor for e^+e^- linear colliders", Nucl. Instrum. and Meth. A311 (1992) 453-464
- [14] T. Shintake et al., "Design if Laser-Compton Spot Size Monitor", proc. XVth Int. Conf. on High Energy Accelerators, Hamburg, Germany, July 20-24, 1992, pp.215-217, KEK Preprint 92-65, July 1992 A.
- [15] T. Shintake et al., "First Beam Test of Nanometer Spot Size Monitor Using Laser Interferometry", proc. 19th Linear Accelerator Meeting in Japan, JAERI, 20-22, July, 1994, pp.102-104
- [16] T. Tauchi, "Beam size monitor by using pairs created in beam-beam interaction at IP", proc. Fifth Int. Workshop Next Linear Colliders, LC93, SLAC Oct. 13-21, 1993, SLAC-436.

