

IMPEDANCE REDUCTION IN THE CERN SPS THROUGH ELEMENT LAYOUT OPTIMISATION

A. Farricker* and C. Vollinger
CERN, Geneva, Switzerland

Abstract

The CERN accelerator complex is currently in its long shutdown while the LHC Injector Upgrade is being carried out. The upgrade includes, but is not limited to, the relocation of the beam dumping system; upgrade of the RF system; replacement of the electrostatic septa and impedance reduction. These major upgrades present an opportunity to perform additional impedance reduction in areas not normally modified due to the large amount of work being performed across the accelerator complex. In this paper, we look at the impedance minimization in the sections near the large aperture quadrupoles of the extraction regions in CERNs SPS. By optimising the locations of existing equipment and introducing a new, more impedance optimised type of bellows, significant reductions in the beam-coupling impedance can be achieved.

INTRODUCTION

The CERN Super-Proton Synchrotron (SPS) has been one of the work horses of the CERN accelerator complex since its commissioning in 1976. Throughout its lifetime it has undergone many modifications and upgrades. The last major overhaul made the SPS the final injector in the accelerator chain of the LHC. In order to prepare the SPS for the High Luminosity-LHC (HL-LHC) era, significant improvements in the form of the LHC Injector Upgrade (LIU) are currently underway [1].

One major goal of the LIU is to reduce the longitudinal beam-coupling impedance in the SPS to improve beam stability. The end result of this is to achieve a doubling of the current bunch intensity from 1.2 to 2.4×10^{11} protons per bunch (ppb). This impedance reduction campaign involves the shielding of the remaining unshielded vacuum flanges and pumping ports, which has been ongoing since the original upgrade for the LHC operation [2–4]. In addition, a complete overhaul of the 200 MHz accelerating system includes the reorganisation of existing structures, an increase in the number of cavity elements, a power upgrade [5] as well as significantly stronger HOM damping [6] and impedance reduction through improved feedback acting on the accelerating mode [7].

Due to the wide ranging scope of work being carried out during Long Shutdown Two (LS2), many areas of the ring which are not usually accessible will be vented. This gives the opportunity to find areas where the beam-coupling impedance can be improved with minimal cost and effort. In this contribution we will focus on the injection/extraction regions of the machine where large aperture

quadrupole (QFA/QDA) magnets are found. The beam-coupling impedances presented have been calculated using the wakefield solver in CST MWS [8].

QFA SECTIONS OF THE SPS

In the injection/extraction regions of the SPS, a larger physical aperture is required to allow the circulating beam and injected/extracted beam to pass simultaneously. This leads to regions of the machine which require atypical (for the SPS) quadrupole (QF/QD) beam pipes with significantly larger apertures. This requirement for larger apertures in both the horizontal and vertical planes is extended to the neighbouring equipment where, consequently, corrector dipoles, vacuum valves and beam position monitors (BPMs) have larger physical apertures. In order to minimise the number of different elements used in the SPS, a circular cross-section, bi-planar BPM and large circular bellows which can both be used in the two large aperture focusing and defocusing quadrupoles are present. An example of a QFA region in the SPS is shown in Fig. 1(a), which also shows the standard configuration of the components in these regions indicating their apertures, Fig. 1(b).

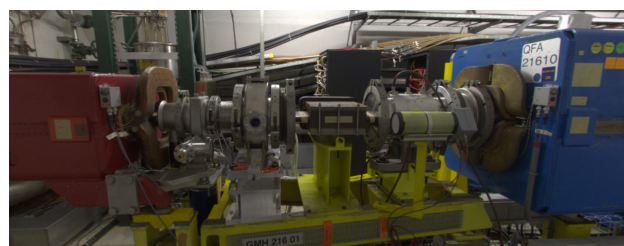

(a) Panorama of area upstream QFA 216 in the SPS tunnel

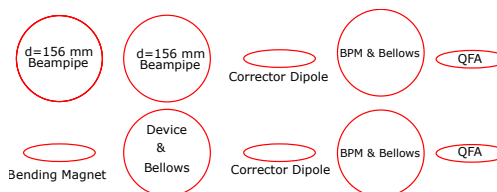

(b) Standard configuration of SPS QFAs

Figure 1: Layout in the SPS QFA regions.

If the vacuum chambers of neighbouring machine elements have different apertures, the result is either a step-in/out transition or, in the worst case, an undesired cavity is shaped. Both cases result in unwanted impedance contributions which can reduce the intensity threshold of the SPS. As a result of the major works carried out in the SPS within the framework of the LIU project, the currently known sources of longitudinal beam instability will be cured. However,

* aaron.farricker@cern.ch

Content from this work may be used under the terms of the CC BY 3.0 licence (© 2019). Any distribution of this work must maintain attribution to the author(s), title of the work, publisher, and DOI

as in the past, reducing known sources of instability often highlights other known or unknown impedance contributors in the machine.

REPLACEMENT OF ROUND BELLOWS

As mentioned before, one of the main issues in the QFA regions is the creation of an unwanted cavity between two flat beam pipes by connecting them via a circular bellows. These cavities have undamped resonances of high quality factor which, once excited by the beam, can couple across the entire bunch train of the SPS (72 bunches spaced by 25 ns).

In the initial construction of the SPS, standardised components were used where possible and bellows with a circular cross-section were chosen due to their mechanical stability. This leads to bellows of large radius which consequently have a lower resonant frequency in the areas where large size of the beam-pipes are required. This low resonance frequency places the excitations in a frequency range where it becomes problematic for longitudinal beam stability.

In order to remove this issue, a new type of bellows with a racetrack shape was developed. This type of bellows was originally designed for use in the new electrostatic septa (ZS) of the SPS [9] and is now reused in the QFA regions. Fig. 2 shows the racetrack-shaped bellows, which has a resonant frequency above 2.6 GHz - i.e. at a frequency less critical for the operation of the SPS.

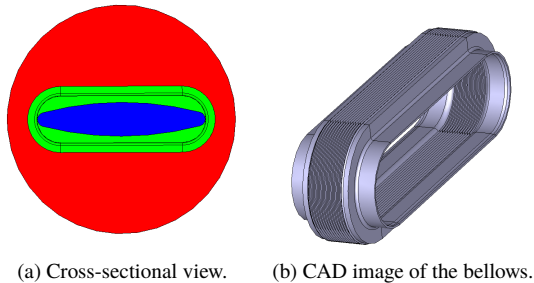

Figure 2: (a): Cross-sections of the racetrack shaped bellows (green) compared the standard round bellows (red) and around the QFA type beam-pipe for reference (blue); (b): rendering of racetrack shaped bellows.

REORGANISING OF EXISTING EQUIPMENT

Area Upstream of QFA 216

The section around QFA 216 is within the slow extraction region upstream of the ZS septa and has a crystal goniometer installed to help to reduce losses on the wires of the ZS. The area also encompasses the closed orbit bump for slow extraction.

The goniometer was designed to minimise the beam coupling impedance by having an aperture equal to that of the upstream elements. Downstream, however, there was a narrowing for a corrector magnet. This was proceeded by a large

circular aperture for the BPM with its bellows as indicated in Fig. 1.

By swapping the order of the corrector magnet and the BPM, greater continuity is maintained immediately downstream of the goniometer. In addition, the exchange of the bellows with a racetrack-shaped bellows removes the unintended cavity completely. The resulting impedance reduction is shown in Fig. 3.

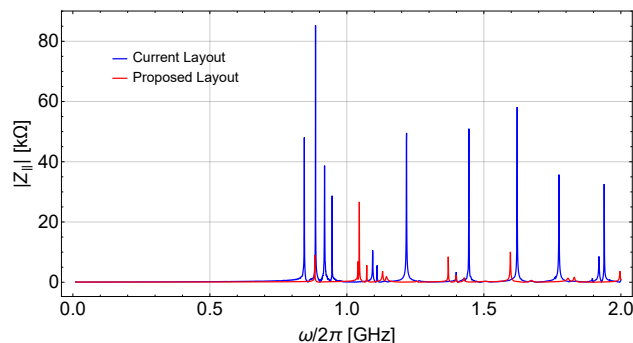

Figure 3: Improvement in the longitudinal beam-coupling impedance upstream of QFA 216.

Area Upstream of QFA 218

Downstream of the ZS there is another QFA, at which point there is spatial separation between the circulating and extracted beams. In this area there is the standard SPS configuration of a corrector magnet followed by the BPM and an attached pumping module, similar to that shown schematically in Fig. 1.

In QFA 218 we opted to swap the BPM—with its attached pumping port—and the corrector magnet. By removing the additional straight piece of pipe, we create space for a racetrack-shaped bellows required before the QFA to allow the mechanical alignment of the objects. The resulting impedance reduction is shown in Fig. 4 and the final layout is similar to the region upstream of QFA 618.

The region downstream of the ZS is particularly activated due to losses during slow extraction which are caused by the scattering of the beam off the septa. This region will only be modified if there is a sufficient drop in the activation.

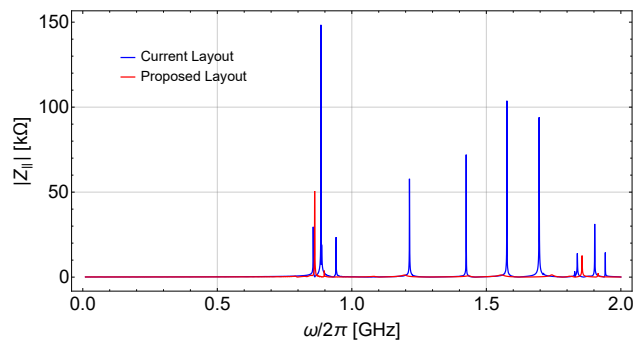

Figure 4: Improvement in the longitudinal beam-coupling impedance upstream of QFA 218.

Area Upstream of QFA 418

The area of QFA 418 is upstream of the extraction septa used for extraction into the LHC. In this area the BPM was already placed in a position where it is not acting as a cavity. The only change required is to swap the large, round bellows with more appropriate racetrack bellows.

The resulting change in the longitudinal beam-coupling impedance and the changes in the layout of the area are shown in Fig. 5.

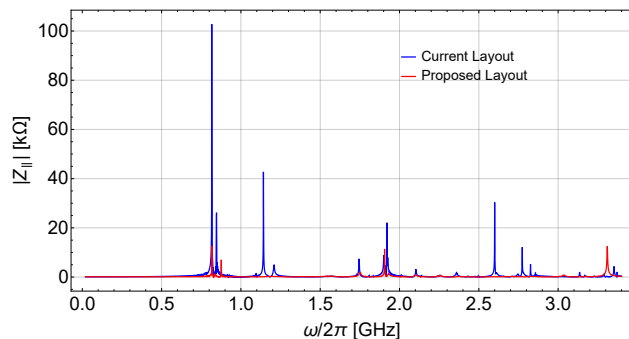

Figure 5: Improvement in the longitudinal beam-coupling impedance upstream of QFA 418.

Area Upstream of QFA 618

The quadrupole QFA 618 is located between two sets of septa used for the extraction of the beam from the SPS to the LHC. By, again, swapping the BPM and the corrector magnet, the impedance can be significantly reduced. The final layout is shown in Fig. 6 and the resulting impedance reduction in Fig. 7.

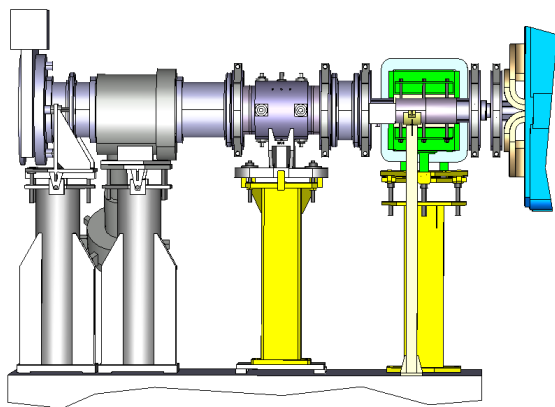

Figure 6: Final layout in the region upstream of QFA 618.

OVERALL IMPACT

By implementing all of the described changes, we will see a significant reduction in the beam-coupling impedance. The total change from the original layouts to the new optimised ones are shown in Fig. 8.

This will be achieved solely through the introduction of a more optimised bellows and the sorting of existing elements.

MC5: Beam Dynamics and EM Fields

D04 Beam Coupling Impedance - Theory, Simulations, Measurements, Code Developments

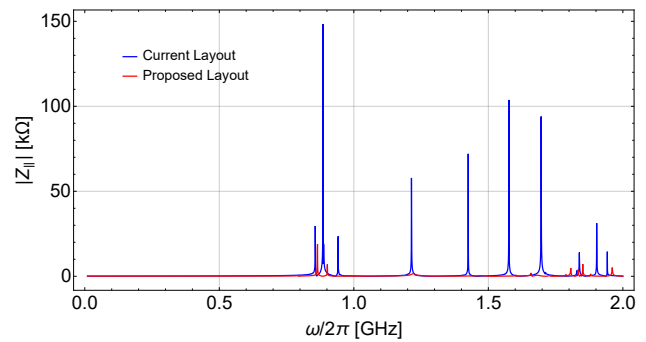

Figure 7: Improvement in the longitudinal beam-coupling impedance upstream of QFA 618.

This highlights how much gain in terms of impedance reduction can be achieved by placing existing equipment in positions which limit the creation of cavity-like structures and steps in cross-sections.

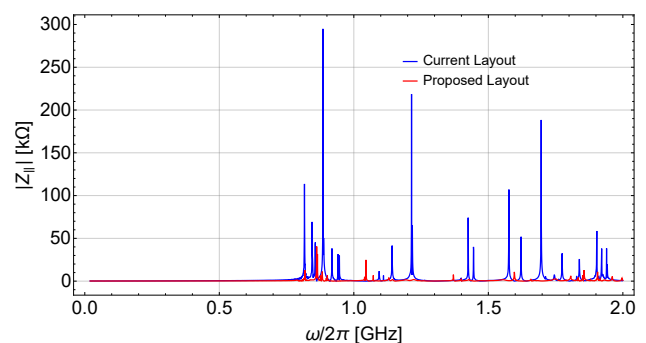

Figure 8: Comparison of longitudinal beam-coupling impedance before and after the impedance reductions for the re-worked areas.

SUMMARY

The reduction of the beam-coupling impedance of the SPS is a key part of making the injector chain fit to act as an injector for the HL-LHC. The LIU project being carried out in LS2 provides a great opportunity to work on improving the impedance in areas which are not normally accessible.

Through the introduction of new, more appropriate bellows and the rearranging of elements currently in the machine, the beam-coupling impedance in the extraction regions of the SPS can be significantly improved. This highlights the fact that a lot of impedance reduction can be achieved by optimising the positions of objects already in the SPS.

REFERENCES

- [1] J. Coupard *et al.*, “LHC Injectors Upgrade TDR”, CERN-ACC-2014-0337.
- [2] E. N. Shaposhnikova, T. Argyropoulos, T. Bohl, A. Lasheen, J. Repond, and H. Timko, “Identification and Reduction of the CERN SPS Impedance”, in *Proc. HB’16*,

MOPGW077

279

- Malmö, Sweden, Jul. 2016, pp. 260–265. doi : 10.18429/JACoW-HB2016-TUAM3X01
- [3] T. Bohl, T. Linnecar, and E. Shaposhnikova, “Impedance Reduction in the CERN SPS as seen from Longitudinal Beam Measurements”, in *Proc. EPAC’02*, Paris, France, Jun. 2002, paper WEPRI083.
- [4] P. Collier *et al.*, “Reducing the SPS Machine Impedance”, in *Proc. EPAC’02*, Paris, France, Jun. 2002, paper WEPRI082.
- [5] E. N. Shaposhnikova, E. Ciapala, and E. Montesinos, “Upgrade of the 200 MHz RF System in the CERN SPS”, in *Proc. IPAC’11*, San Sebastian, Spain, Sep. 2011, paper MOPC058, pp. 214–216.
- [6] P. Kramer and C. Vollinger, “HOM-Mitigation for Future SPS 33-Cell 200 MHz Accelerating Structures”, in *Proc. ICAP’18*, Key West, FL, USA, Oct. 2018, pp. 35–41, doi : 10.18429/JACoW-ICAP2018-SAPAG04
- [7] P. Baudrenghien, “Control of Strong Beam Loading: Results With Beam”, 11th Workshop of the LHC, Chamonix, France, 2001.
- [8] CST Microwave Studio Suite, <https://www.cst.com>
- [9] B. Balhan *et al.*, “Improvements to the SPS Slow Extraction for High Intensity Operation”, CERN-ACC-NOTE-2019-0010, Mar. 2019.