

A compact multi-plate fission chamber for the simultaneous measurement of ^{233}U capture and fission cross-sections

M. Bacak^{1,2,6,a}, E. Berthoumieux², M. Aiche³, G. Bélier⁴, R. Cardella¹, A. Chatillon⁴, M. Diakaki², E. Dupont², F. Gunsing^{1,2}, J. Heyse⁵, S. Kopecky⁵, B. Laurent⁴, H. Leeb⁶, L. Mathieu³, P. Schillebeeckx⁵, J. Taieb⁴, V. Vlachoudis¹, and the n_TOF Collaboration

¹ CERN, Geneva, Switzerland

² Irfu, CEA, Université Paris-Saclay, Gif-sur-Yvette, France

³ CENBG, CNRS/IN2P3-Université de Bordeaux, Gradignan, France

⁴ CEA, DAM, DIF, 91297 Arpajon, France

⁵ EC-JRC Geel, Belgium

⁶ TUW Atominstitut, Vienna, Austria

Abstract. ^{233}U plays the essential role of fissile nucleus in the Th-U fuel cycle. A particularity of ^{233}U is its small neutron capture cross-section which is about one order of magnitude lower than the fission cross-section on average. Therefore, the accuracy in the measurement of the ^{233}U capture cross-section essentially relies on efficient capture-fission discrimination thus a combined setup of fission and γ -detectors is needed. At CERN n_TOF the Total Absorption Calorimeter (TAC) coupled with compact fission detectors is used. Previously used MicroMegas (MGAS) detectors showed significant γ -background issues above 100 eV coming from the copper mesh. A new measurement campaign of the ^{233}U capture cross-section and alpha ratio is planned at the CERN n_TOF facility. For this measurement, a novel cylindrical multi ionization cell chamber was developed in order to provide a compact solution for 14 active targets read out by 8 anodes. Due to the high specific activity of ^{233}U fast timing properties are required and achieved with the use of customized electronics and the very fast ionizing gas CF_4 together with a high electric field strength. This paper describes the new fission chamber and the results of the first tests with neutrons at GELINA proving that it is suitable for the ^{233}U measurement.

1. Introduction

^{233}U plays the essential role of fissile nucleus in the ThU fuel cycle [1,2], which has been proposed as an alternative to the U-Pu fuel cycle. Considering the scarce data available to assess the capture cross section, a first measurement [3] was proposed and successfully performed at the n_TOF facility at CERN using the 4π Total Absorption Calorimeter (TAC) [4]. The measurement was extremely difficult due to the need to accurately distinguish between capture and fission gamma-rays without any additional discrimination tool and the measured capture cross section showed a significant disagreement in magnitude when compared with the ENDF/B-VII.1 library despite the agreement in shape.

A new measurement [5] is going to be carried out that is aimed at providing a higher level of discrimination between competing nuclear reactions, to extend the neutron energy range and to obtain more precise and accurate data, thus fulfilling the demands of the “NEA High Priority Nuclear Data Request List” [6] for the $^{233}\text{U}(n,\gamma)$ cross section from thermal neutron energies up to 10 keV. The setup is envisaged as a combination of the 4π Total Absorption Calorimeter (TAC) with the new compact multi-plate fission chamber instead

of a MicroMegas (MGAS) detector because it was a source of significant background above 100 eV in similar experiments [7].

The development of the fission chamber was focused on different points: compact design, fast and heavy ionizing gas and optimized electronics to ensure unambiguous alpha-fission discrimination for fission tagging; very low quantities of structure material to avoid neutron scattering background as well as parasitic reactions; and a reasonable amount of ^{233}U to obtain the needed count rate for a measurement with sufficient statistics.

2. Structure of the chamber

The detector is a multi-plate fission chamber containing two stacks of axial ionization cells. Figures 1 and 2 show a picture and a CAD drawing of the chamber. The housing is made of a tube of 1.5 mm thick aluminium with an outer diameter of 66 mm and a length of 78 mm.

Two stacks of 4 anodes and 7 cathodes each are mounted inside the housing. The arrangement of the cathodes and anodes in one stack is shown in Fig. 3. The stacks are directly attached to their respective motherboards. In order to reduce the amount of material in beam, limiting the neutron scattering, the anodes and cathodes were chosen to be made out of aluminium with thicknesses of 20 μm and 10 μm respectively.

^a e-mail: Michael.Bacak@cern.ch

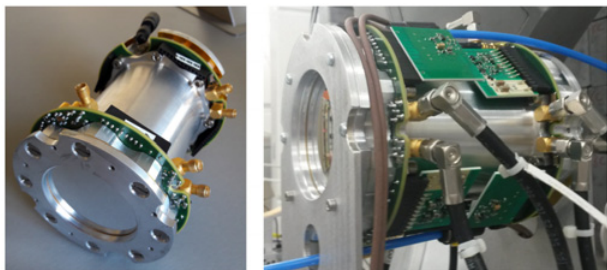

Figure 1. Pictures of the fission chamber. Left: without preamplifiers and cabling. Right: chamber mounted on a support and in working conditions.

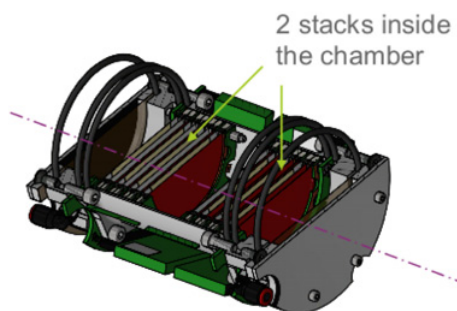

Figure 2. 3D-CAD drawing of the fission chamber with sectional view. The green blocks around the chamber represent the preamplifiers.

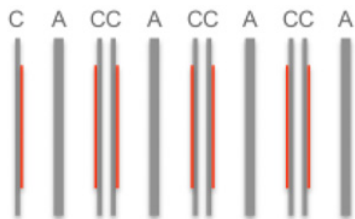

Figure 3. Arrangement of the cathodes and anodes of one stack. Fissile deposits are indicated in red.

Those thicknesses ensure that alpha-crossing between the different ionizing cells is avoided. The cathodes are connected to the ground, while the anodes are polarized to a potential of 420 V with a 3 mm wide inter-electrode gap. The motherboard feeds the signal to the preamplifiers and a shaper mounted directly on the motherboard but outside of the aluminium housing. Following the motherboards, special aluminium flanges that hold the gas feedthroughs are attached and the chamber is closed by another pair of flanges supporting aluminized Kapton windows with a thickness of 25 μm to create a Faraday cage. The diameter for the neutron beam in all parts is at least 50 mm wide.

3. ^{233}U deposits

^{233}U emits alpha particles and undergoes fission induced by neutron absorption. Both events produce signals related to the energy loss in the gas of the chamber. It is crucial to discriminate between those two classes of events as those events will later be tagged to the γ -events of the TAC in coincidence.

In order to reach a good alpha-fission discrimination, the thickness of the deposit should be small. On the

other hand, to achieve good statistics for the capture cross-section in a reasonable amount of time more ^{233}U mass is needed. The second constraint is more critical and the chamber was optimized for higher masses.

The 14 targets that are going to be used were produced by molecular plating by JRC-Geel. The circular spots have a diameter of 4 cm and areal densities between 250–350 $\mu\text{g}/\text{cm}^2$, resulting in a total mass of about 50 mg ^{233}U .

A challenging characteristic of ^{233}U is the high activity which leads to a significant amount of self-sputtering of the samples and therefore contamination of the environment. For this reason, the possibility to cover the deposits with a thin polyimide film to reduce the contamination was tested. Nevertheless, in first performance tests with ^{235}U three of the targets were coated with different polyimide films with areal densities of 31.5, 44 and 55 $\mu\text{g}/\text{cm}^2$ and their influence on the measured results, i.e. the alpha-fission fragment separation was investigated. The result of these tests are briefly discussed in Sect. 6.

4. Gas simulations

The choice of the gas is of utmost importance to guarantee fast signals and therefore reduce the probability of α -pile-up. It has to exhibit a high drift velocity and provide a good alpha-fission separation. In time of flight measurements like the foreseen one, time resolution is a key point to further analysis of the data. Electron-ion pairs are created when charged particles are emitted by fission or alpha activity. The electrical signal on the electrodes is mainly due to the drift of electrons towards the anode. The faster the electron the shorter the rise time of the signal. This is described by the electron drift velocity and a high drift velocity is therefore desirable.

From other sources [8] tetrafluoromethane CF_4 was investigated and has proven suitable as an ionizing gas that fulfils the specifications of the foreseen experiment with ^{233}U . Compared to most gases used in ionization chambers, CF_4 gas also offers the advantage to show a higher density. Hence it allows a small gap distance between anodes and cathodes to be kept even at atmospheric pressure which allows for a compact design.

To properly separate alpha decay and fission events the electric charge induced by an alpha particle in the gas should be less than that of a fission fragment for all emission angles. The induced charge on the anode depends on the initial charge created by the particle, the gap size between anode and cathode and the charges path length. The worst case occurs when alpha particles are emitted parallel and fission fragments perpendicular to the cathode's surface. In that case the full alpha energy (about 5 MeV for ^{233}U alpha particles) gets deposited. Assuming a constant stopping power along the trajectory a fission fragment should lose at least twice that energy to induce the same charge as a worst case alpha emission. With high alpha activity, alpha pile-up occurs and leads to a degradation of the separation. For a light fission fragment ($Z = 36$) at 120 MeV, LISE++ [9], with the method from [10] for energy loss calculations show that an energy loss of 24 MeV in CF_4 at atmospheric pressure correspond to a path of 1.5 mm. To limit the overlap between alpha and fission signals, and due to mechanical considerations, the gap size was chosen to be 3 mm.

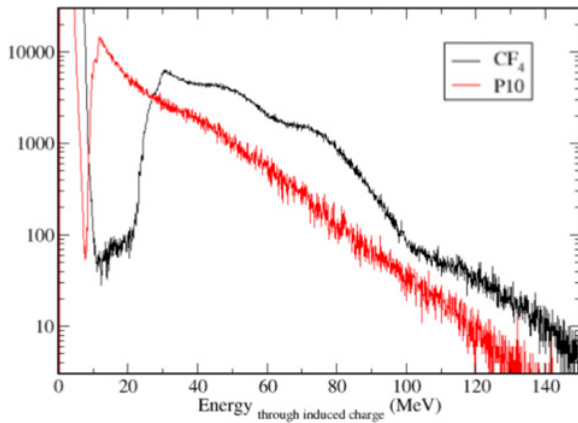

Figure 4. MCNPX simulation of α -FF discrimination assuming for one sample (in 2π): $A_\alpha = 560$ kBq, $A_{FF} = 100$ FF/s whilst α pile-up is being taken into account.

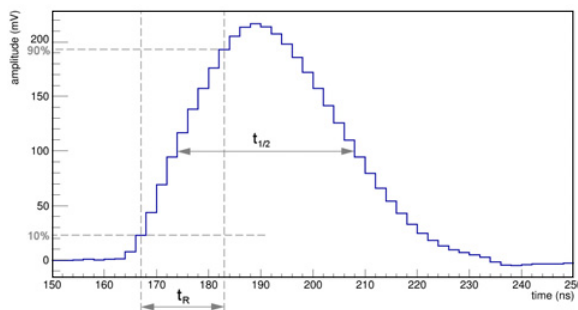

Figure 5. Typical signal of a fission fragment with a rise time $t_R = 16$ ns and a signal duration $t_{1/2} = 34$ ns.

Figure 4 compares the simulated alpha-fission fragment separation at a pressure of 1050 mbar for CF_4 and P10 which is a common fill gas. The distinct advantage in the performance of CF_4 in the simulations can be seen clearly and therefore it was chosen as the ionizing gas in order to work at atmospheric pressure. However, CF_4 has the disadvantage to be very sensitive to oxygen impurities, therefore high purity CF_4 gas has to be used. In addition, a permanent gas flux in the chamber is required and will be guaranteed by a gas regulation system to insure a constant flux at a pressure of 1050 mbar during the whole measurement.

5. Electronics and acquisition system

5.1. Preamplifier and timing filter amplifier

A particularity of ^{233}U is the high alpha activity due to its half-life of about 160,000 years. One can expect about 1 MBq per anode depending on the actual mass of the deposits which requires fast and low-noise electronics in addition to a fast ionizing gas. A dedicated card combining a preamplifier and a shaper was developed at CEA Bruyères-le-Châtel to meet the requirements of this fission chamber. Four of these cards will be mounted on the specifically designed motherboards. The signals from the four cards are taken from SMA connectors and one common high voltage is provided through another SMA connector. An example of a typical FF-signal is shown in Fig. 5 with a signal duration $t_{1/2}$ of 34 ns at 50% of the

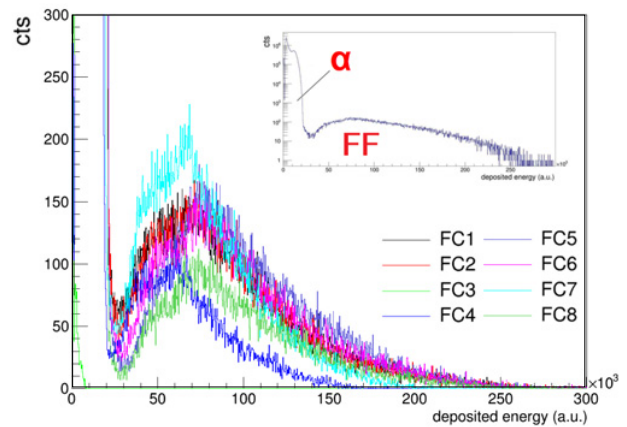

Figure 6. Alpha-fission fragment separation measured for all the eight individual chambers/anodes. Zoomed out in the log plot the drastic difference in count rates between the alpha and the fission events becomes apparent. FC3 was disconnected during this test.

maximum amplitude and a rise time t_R of 16 ns taken from 10%–90% of the maximum amplitude.

5.2. Digital acquisition system: FASTER

In the performance measurements and first characterization of the chamber the signals from the fission chamber were directly sent to the digital acquisition system FASTER (Fast Acquisition SysTEM for nucleAR Research), currently developed at LPC Caen [11]. FASTER uses 12 bits Analog-to-Digital Converters (ADC) and digitizes signals at a 500 MHz sampling rate. Real time numerical modules, implemented of FPGAs process the signals and the real-time treatment is fast enough to deal with high count rates up to 700,000 events per second. Through a graphical user interface and an online visualization program the experiment can be set up and adjusted. Only relevant parameters (timing, integrated charge, amplitude, etc.) are stored.

6. Performance measurements

First performance measurements with the new chamber were carried out at the pulsed neutron time-of-flight facility GELINA at JRC-Geel, Belgium. Due to the difficult handling of the ^{233}U targets it was decided to do the tests with ^{235}U targets. The chamber performance obtained, in terms of alpha-fission fragment separation, is shown in Fig. 6. The overlap between alpha and fission is higher than expected from the simulations but still a nice cut can be set in the valley between the two regions. A possible explanation is that the simulation did not consider roughness of the targets, which could deteriorate energy loss of the fission fragments. From the experimental side one has to consider that the cathodes and anodes are neither perfectly flat nor perfectly parallel to each other which leads to geometrical deviations in gap size and electric field strength and therefore energy deposited.

During the test measurement at JRC-Geel with GELINA running at 50 Hz and with ^{235}U in beam the count rates were 0.6 FF/s and 520 Bq in alpha activity per channel of the chamber.

The targets with polyimide film are read out by anode 4 and 7 (FC4 and FC7 in Fig. 6). One can

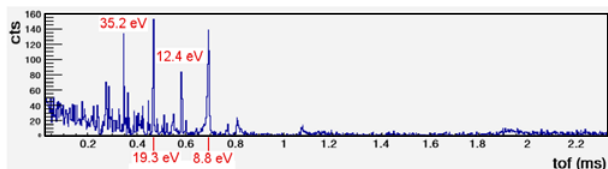

Figure 7. Time-of-flight spectrum for ^{235}U fission events at flight path length of 28.35 m. The neutron energy of the most dominant resonances is given in red.

observe a slight shift to smaller deposited energies for those channels which is expected due to the additional material the particles have to pass through. The influence of the polyimide film on the separation of alpha and fission fragments is negligible and the separation stays comparable to those without PI films. Nevertheless, due to the complexity in handling these foils, the ^{233}U samples will be mounted without PI film coating.

In Fig. 7 a time-of-flight spectrum of ^{235}U fission events for one channel is shown which was taken at 28.35 m flight path length and an accelerator frequency of 50 Hz. The timing information for fission events is crucial for the later analysis of the emitted gamma-rays detected with the TAC. The $^{235}\text{U}(n,f)$ resonances in Fig. 7 are at the expected positions in time-of-flight for this flight path length which proves the chamber is working as expected.

7. Measurement at n_TOF

For the measurement at n_TOF the fission chamber will be equipped with a total amount of about 50 mg of ^{233}U which is then placed inside the TAC. The triggers from fission events will then be used to perform a fission tagging measurement of the ^{233}U capture cross-section.

At the same time the TAC of n_TOF has received an upgrade with new designed voltage dividers. First tests during the commissioning show a smoother signal behaviour and a better recovery time after the gamma flash, meaning that measuring up to higher energies will be possible.

Inside the TAC a spherical shell made of polyethylene and lithium is covering the fission chamber to prevent scattered neutrons from going into the scintillators of the TAC. This shell is called the absorber and it was designed and machined to fit perfectly around the new fission chamber while leaving enough space for gas tubes and cables.

In addition to the experimental program, Geant4 simulations are going to be used to do detailed neutron scattering studies due to the chamber and the rest of

the experimental setup. Furthermore, an identical dummy chamber was also produced to measure the background coming from neutron scattering caused by the chamber.

8. Conclusions

The developed fission chamber works and provides an excellent timing and a fair performance in terms of alpha-fission fragment separation both essential for the measurement at CERN n_TOF. The ratio between alpha activity and fission fragments produced with ^{233}U will be significantly higher than with ^{235}U . This means the behaviour will be worse compared to ^{235}U . However, thanks to the combination of the TAC and the fission tagging method the discrimination between alphas and fission fragments will improve further so the loss in the particle discrimination due to increased pile-up can be compensated.

This work was partially supported by the French NEEDS/NACRE Project and by the European Commission within HORIZON2020 via the EURATOM Project EUFRAT. The authors would like to acknowledge more specifically JRCGeel for targets preparation and for providing full support for the first tests of the fission chamber and its electronics at GELINA.

References

- [1] V.G. Pronyaev, IAEA Report, INDC(NDS)408 (1999)
- [2] The Generation IV International Forum, <http://www.gen-4.org/> (2013)
- [3] C. Carrapico et al., Nucl. Instr. Meth. A **704**, 60 (2013)
- [4] C. Guerrero and The n_TOF Collaboration, Nucl. Instr. Meth. A **608**, 424 (2009)
- [5] C. Carrapico, E. Berthoumieux and the n_TOF Collaboration, CERN-INTC-2013-041/INTC-P-397 (2013)
- [6] NEA Nuclear Data High Priority Request List, <https://www.oecd-nea.org/dbdata/hpr1/> (2013)
- [7] J. Balibrea and the n_TOF Collaboration, Nuclear Data Sheets **119**, 10 (2014)
- [8] J. Taieb, B. Laurent, G. Bélier, A. Sardet, C. Varignon, Nucl. Instr. Meth. A **833**, 1 (2016)
- [9] O.B. Tarasov, D. Bazin, Nucl. Instr. Met. B **266**, 4657 (2008)
- [10] J.F. Ziegler, SRIM2000, Pergamon Press, NY, 1985
- [11] Fast Acquisition SysTem for nuclEar Research, <http://faster.in2p3.fr/> (2013)