

THE PSB OPERATIONAL SCENARIO WITH LONGITUDINAL PAINTING INJECTION IN THE POST-LIU ERA

V. Forte*, S. Albright, M. E. Angoletta, P. Baudrenghien, E. Benedetto, A. Blas, C. Bracco, C. Carli, A. Findlay, R. Garoby, G. Hagmann, A.M. Lombardi, B. Mikulec, M. Paoluzzi, J. Sanchez Alvarez, R. Wegner, CERN, Geneva, Switzerland

Abstract

Longitudinal painting has been presented as an elegant technique to fill the longitudinal phase space at injection to the CERN PSB once it is connected with the new Linac4 [1]. Painting brings several advantages related to a more controlled longitudinal filamentation, lower peak line density and beating reduction, resulting in a smaller space-charge tune spread. This could be an advantage especially for high intensity beams ($> 6 \times 10^{12}$ protons per bunch) to limit losses on the transverse acceptance of the machine. This paper presents an overview on the possible advantages of the technique for operational and test beams, taking care of the hardware limitations and possible failure scenarios.

INTRODUCTION

In the frame of the upgrades foreseen for the LHC injectors (LIU project [2]), Linac4 [3] will send H^- ions on to a stripping foil at 160 MeV. The fully stripped H^+ ions will be injected in the PSB, while the partially stripped H^0 and unstripped H^- will be dumped. The increase in $\beta\gamma^2$ by a factor two, with respect to the present 50 MeV injection from Linac2, will double the brightness in the PSB assuming the same transverse space charge (SC) tune spread of today.

An optimisation of the longitudinal parameters [4] could further enhance the brightness achievement obtained by the increase in the injection energy. Two different schemes are foreseen: “un-modulated” and “modulated” injection.

The “un-modulated” injection scheme is the baseline for HL-LHC beams. It consists in a multi-turn injection of chopped trains of Linac4 bunches (at 352.2 MHz) with a fixed bunch length and energy spread. In this configuration the energy offset ΔE_0 is equal to 0 and the number of injection turns to integrate the desired number of charges in the PSB depends on the current delivered by the linac. Latest estimations for the future LHC standard intensity (3.4×10^{12} p) predict 23 turns, considering 40 mA before chopping, 63% chopping factor (CF), 403 keV rms energy spread (δE) and 100% transmission [4]. A disadvantage of the “un-modulated” injection scheme is the limited possibility to uniformly fill the buckets and thus minimise the longitudinal filamentation. This effect is due to pure geometrical reasons, as the almost rectangular shape of the injected bunches do not match with the longitudinal iso-Hamiltonian contour (target area, see Fig. 1). Almost all the bunches are injected into the PSB in a double harmonic (h) radio-frequency (RF) bucket with voltages (V) in anti-phase, in

order to smear the peak line density and, thus, reduce the transverse SC tune spread. LIU beams will be produced by injecting the train of Linac4 bunches in an accelerating bucket. The result of dedicated simulations is presented in Fig. 1 and shows the longitudinal phase space of the first injected bunch in the PSB for $V_{h=1}=8$ kV, $V_{h=2}=6$ kV and $B\rho = 10 \frac{Tm}{s}$, for a target matched area of 1.5 eVs at 160 MeV.

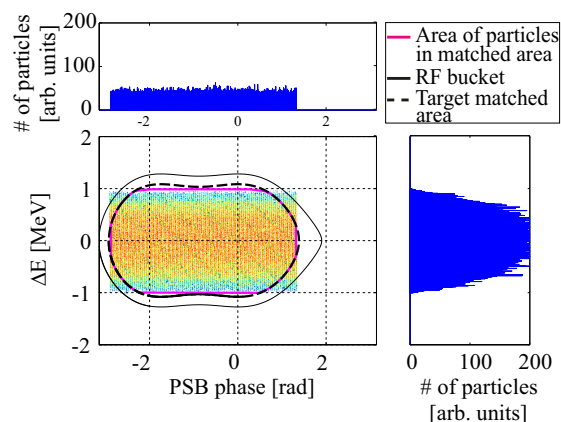

Figure 1: The first (un-modulated) injection in a PSB ring.

Uniformity index

A “uniformity index” (UI) has been defined in order to evaluate how well a particle distribution matches the target area:

$$UI = \frac{\text{Part. in matched area} \times \text{Area of part. in matched area}}{\text{Total nr. of part.} \times \text{Target matched area}} \quad (1)$$

A scan of possible injection parameters with large energy spreads suggests, for the target longitudinal emittance, $\delta E_{rms}=450$ keV and $CF=0.67$, leading to $UI=0.776$.

THE MODULATED INJECTION: LONGITUDINAL PAINTING

The longitudinal filamentation due to the geometrical mismatch between iso-Hamiltonians and injected bunches can be minimised by adopting the “longitudinal painting” technique. This technique was proposed for the future PSB injection by C. Carli and R. Garoby [1] in order to uniformly fill a receiving RF iso-Hamiltonian. This would allow to minimise the peak line density along the cycle or, equivalently, maximise the bunching factor \bar{J}/\hat{J} , where J is the bunch current. These quantities are correlated to the transverse SC tune spread and thus affect the brightness of the beams which can be delivered by the PSB.

* vincenzo.forte@cern.ch

The longitudinal structure of the beams produced by Linac4 can be tuned by means of: the chopper, which modulates the chopping factor in time, the de-buncher, which controls the rms energy spread δE and the last two PIMS cavities [5], which allow a variation in time of the energy offset ΔE_0 , as shown in Fig. 2 (right).

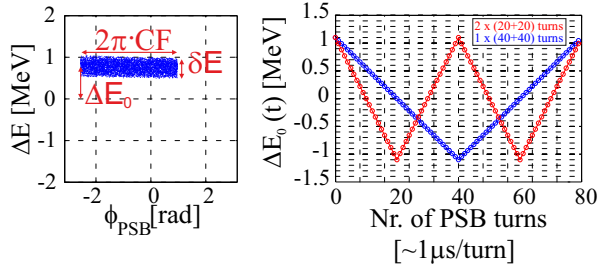

Figure 2: An example of injected beam (left) and two possible $\Delta E_0(t)$ functions with 1 (blue) and 2 (red) modulations.

The central energy sweep is limited in speed ($d\Delta E_0(t)/dt$) and amplitude by the available power in the de-buncher cavity, which allows a δE_{rms} at the entrance of the PSB between 80 and 450 keV at a phase swing speed of $\sim 5.5 \text{ deg}/\mu\text{s}$. This implies, to date, a minimum $\Delta E_0(t)$ sweeping period of 80 turns for $\Delta E_{0,max} = 1.2 \text{ MeV}$ [6], as plotted in Fig. 2 (right - blue).

Studies on possible modulations to obtain the highest UI for typical painting parameters show that fast modulations are unnecessary while a more precise painting can be achieved with smaller energy spreads. Moreover, small CF have to be foreseen for large values of $\Delta E_{0,max}$. The limitation, in this sense, is related to the minimum pulse length of the chopper (e.g. 25 ns [7]), which limits the chopping factor to ~ 0.025 . The result of these studies is in Table 1 and in Fig. 3.

Table 1: Achieved UI for Different Longitudinal Painting Schemes

| Nr. of modulations [-] | $\Delta E_{0,max}$ [MeV] | δE [keV rms] | Matched,area [eVs] | Min. CF | UI |
|------------------------|--------------------------|----------------------|--------------------|-------------|--------------|
| 1 | 0.8 | 120 | 1.5 | 0.55 | 0.829 |
| 1 | 1.1 | 120 | 1.5 | 0.06 | 0.815 |
| 1 | 0.8 | 250 | 1.5 | 0.55 | 0.816 |
| 1 | 1.1 | 250 | 1.5 | 0.06 | 0.765 |
| 2 | 0.8 | 120 | 1.5 | 0.56 | 0.824 |
| 2 | 1.1 | 120 | 1.5 | 0.36 | 0.811 |
| 2 | 0.8 | 250 | 1.5 | 0.56 | 0.817 |
| 2 | 1.1 | 250 | 1.5 | 0.36 | 0.761 |

LONGITUDINAL PAINTING CONTROL

A new painting control algorithm, developed from the strategy proposed in [1], foresees the dynamic adaptation of the CF to the bucket shapes by modulating the longitudinal beam parameters through an iterative approach. The syn-

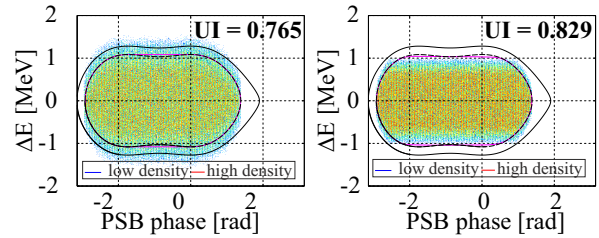

Figure 3: UI for longitudinal painting.

optic of the algorithm is presented in Fig. 4. The input and output variables are listed in Tables 2 and 3.

Table 2: Inputs and Inputs/Outputs

| Input/Output | Description | Value |
|----------------|---|----------------------|
| H.I.1 | Linac4 current right before chopping [mA] | 40 |
| H.I.2 | Target intensity per ring [p] | 1.6×10^{13} |
| H.I.3 | Target longitudinal emittance [eVs] | 1.5 |
| H.I.4 | Nr. of ΔE_0 modulation periods | 1 |
| H.I.O.5 | $\Delta E_{0,max}$ [MeV] | 1.1 |
| H.I.O.6 | δE [keV rms] | 120 |
| A.I.1 | Target area (numerical / analytical) | |

Table 3: Outputs of the Longitudinal Painting Algorithm

| Output | Description | Destination |
|--------------|-------------------------------|--------------------------|
| H.O.1 | $\Delta E_0(t)$ look-up table | PIMS cavities controller |
| H.O.2 | ON-OFF sequence | Chopper controller |
| H.O.3 | Minimum energy spread | De-buncher controller |

The algorithm starts with a first estimate of the largest possible CF for the target contour, provided by an analytical or numerical tool. The number of injection turns is then calculated as a function of Linac4 un-chopped current, CF modulation and the target accumulated intensity. The modulation in time $\Delta E_0(t)$ is computed from the number of turns, the number of modulation periods and the maximum energy sweep. The intersections of the modulation lines with the target contour provide an assessment of the variation of the chopping factor during the injection process, as shown in Fig. 5. It is important to underline that “empty” intersections must be considered as painting inaccuracy. The algorithm reacts, in this case, by reducing the value of $\Delta E_{0,max}$ to avoid this condition. Due to the convex shape of the iso-Hamiltonian, some particles fall outside the bucket contour and the accumulated intensity, after the first computation, is hence lower than the target one. The algorithm increases then the number of turns, producing a slower energy modulation (for example 106 PSB turns instead of 93 for a target intensity of 1.6×10^{13} p) which is also less demanding according to the de-buncher dynamics. Two different chopping patterns are shown in Fig. 6. The final chopping pattern is then transferred to the chopper controller into a sequence of 0/1 (chopper ON/OFF). The sequence is limited in time by the distribution kicker in the PSB injection line (BI.DIS) which allows up to 150 turns of injection per ring.

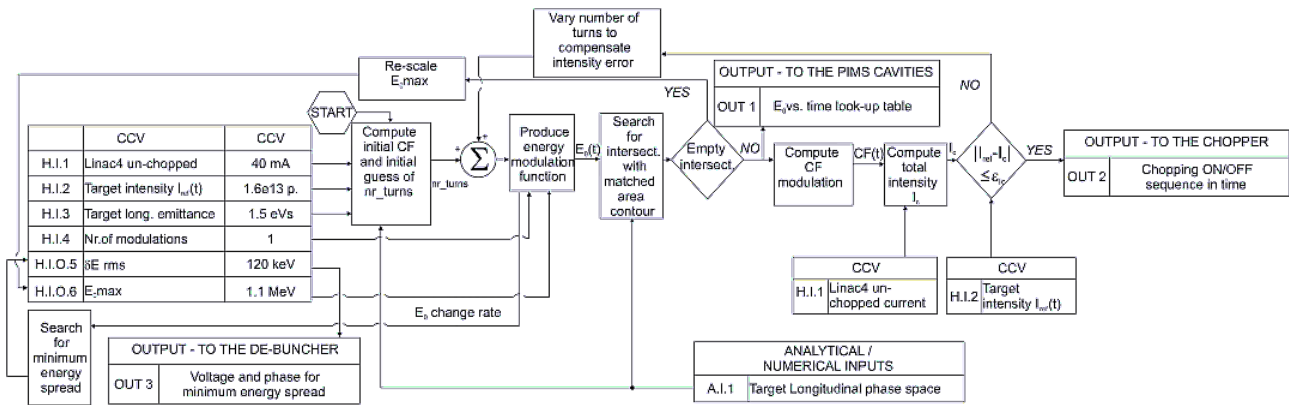

Figure 4: A synoptic of the longitudinal painting control algorithm.

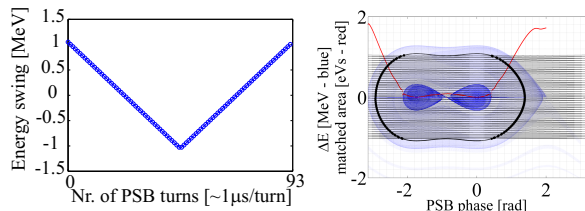

Figure 5: First triangular waveform (left) and intersections with the target contours (black dots - right).

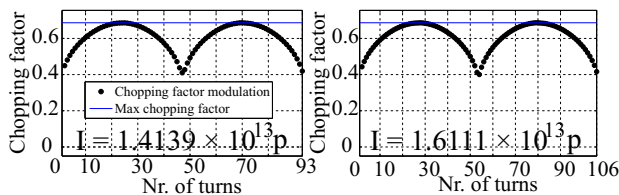

Figure 6: The chopping modulation in time before (93 PSB turns, left) and after (106 PSB turns, right) the iteration.

SIMULATIONS

Simulations for high intensity beams (future ISOLDE, 1.3×10^{13} p/bunch) were performed with the PTC-ORBIT code [8] and the results confirmed that the longitudinal painting can increase the bunching factor and reduce its beating in time with respect to the un-modulated injection, as shown in Fig. 7.

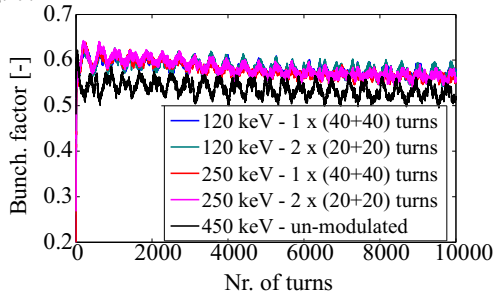

Figure 7: PTC-Orbit simulations of achievable bunching factors for future ISOLDE beams with $\Delta E_{0,max} = 1.1$ MeV and different painting parameters.

The flexibility of the painting allows the creation of any possible operational longitudinal bunch shape at injection,

like “hollow bunches” [9], injections in $h=2$ and future triple harmonic profiles [10]. “Hollow bunches” are usually obtained through complex RF gymnastics [11]. Considering the maximum 2 MHz repetition rate of the chopper pulse [7], the painting can easily fill the lateral branches of the “hollow bunches” by alternating, at every turn, the chopping pattern. A possible pattern, shown in Fig. 8 (left), leads to an expected hollow distribution after ~ 10 ms as in Fig. 8 (right).

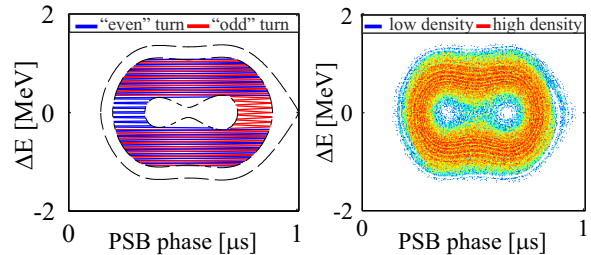

Figure 8: BlonD [12] simulation for “hollow bunches”.

CONCLUSIONS AND OUTLOOK

The longitudinal painting has been introduced as an elegant technique to fill the PSB longitudinal phase space at injection. The flexibility of the painting allows to reach a higher and more stable bunching factor, which is an important factor to reduce the transverse SC tune spread [1].

The painting shows a large potential: it copes with the geometrical mismatch between the typical Linac4 bunches and the PSB RF iso-Hamiltonians and can be adapted to every operational beam’s longitudinal phase space.

The development of an operational control algorithm has been presented. A “measurement loop” on the machine can be foreseen to react to errors occurring in the real machine, as synchronisation issues and inefficiency at injection.

Results of simulations for future ISOLDE beams and possible application for the production of “hollow” bunches have been presented. Future developments will focus on the operational implementation of the algorithm, including the hardware limitations and the adaptation to the control framework of the PSB.

REFERENCES

- [1] C. Carli and R. Garoby, "Active Longitudinal Painting for the H- Charge Exchange Injection of the Linac4 Beam into the PS Booster", CERN, AB-Note-2008-011 ABP.
- [2] The LIU project: <https://espace.cern.ch/liu-project/default.aspx>
- [3] L. Arnaudon *et al.*, "Linac4 Technical Design Report", CERN-AB-2006-084.
- [4] V. Forte, "Performance of the CERN PSB at 160 MeV with H⁻ charge exchange injection", CERN-THESIS-2016-063.
- [5] F. Gerigk and R. Wegner, "Design of the PI-Mode Structure (PIMS) for Linac4", in *Proc. PAC'09*, Vancouver, BC, Canada, paper FR5REP051.
- [6] R. Wegner, "Linac4 Debuncher - Cavity and Amplifier Updates", at LIU-PSB Injection Meeting #23, <https://indico.cern.ch/event/570568/>
- [7] M. Paoluzzi, "LINAC 4 800V CHOPPER PULSER (Cabling & Mechanics)", CERN EDMS: 1213756.
- [8] A. Shishlo *et al.*, "Synopsis of the PTC and ORBIT integration. KEK Internal Report (A)", 2007-4, Nov. 2007.
- [9] A. Oeftiger, H. Bartosik, A. Findlay, S. Hancock, and G. Rumolo, "Flat Bunches With a Hollow Distribution for Space Charge Mitigation", in *Proc. IPAC'16*, Busan, Korea, May 2016, paper MOPOR023, pp. 652-655.
- [10] E. Benedetto *et al.*, "Machine Development Studies In The CERN PS Booster, in 2016", presented at IPAC'17, Copenhagen, Denmark, paper WEPVA037.
- [11] A. Oeftiger and S. Hancock, "Hollow Bunch Production", presentation at the Injector MD days 2017, March 23, 2017, <https://indico.cern.ch/event/609486/>.
- [12] CERN Beam Longitudinal Dynamics code BLonD <http://blond.web.cern.ch/>